

Personal Computer

US \$3.00 FF 18.50 SFr 7.30 IR £1.41 BFr 99.00
Lire 5.700 DKr 27.00 DM 9.5

World

August 1985 95p

Mice break out
at
home

BRITAIN'S BIGGEST MICROCOMPUTER MAGAZINE

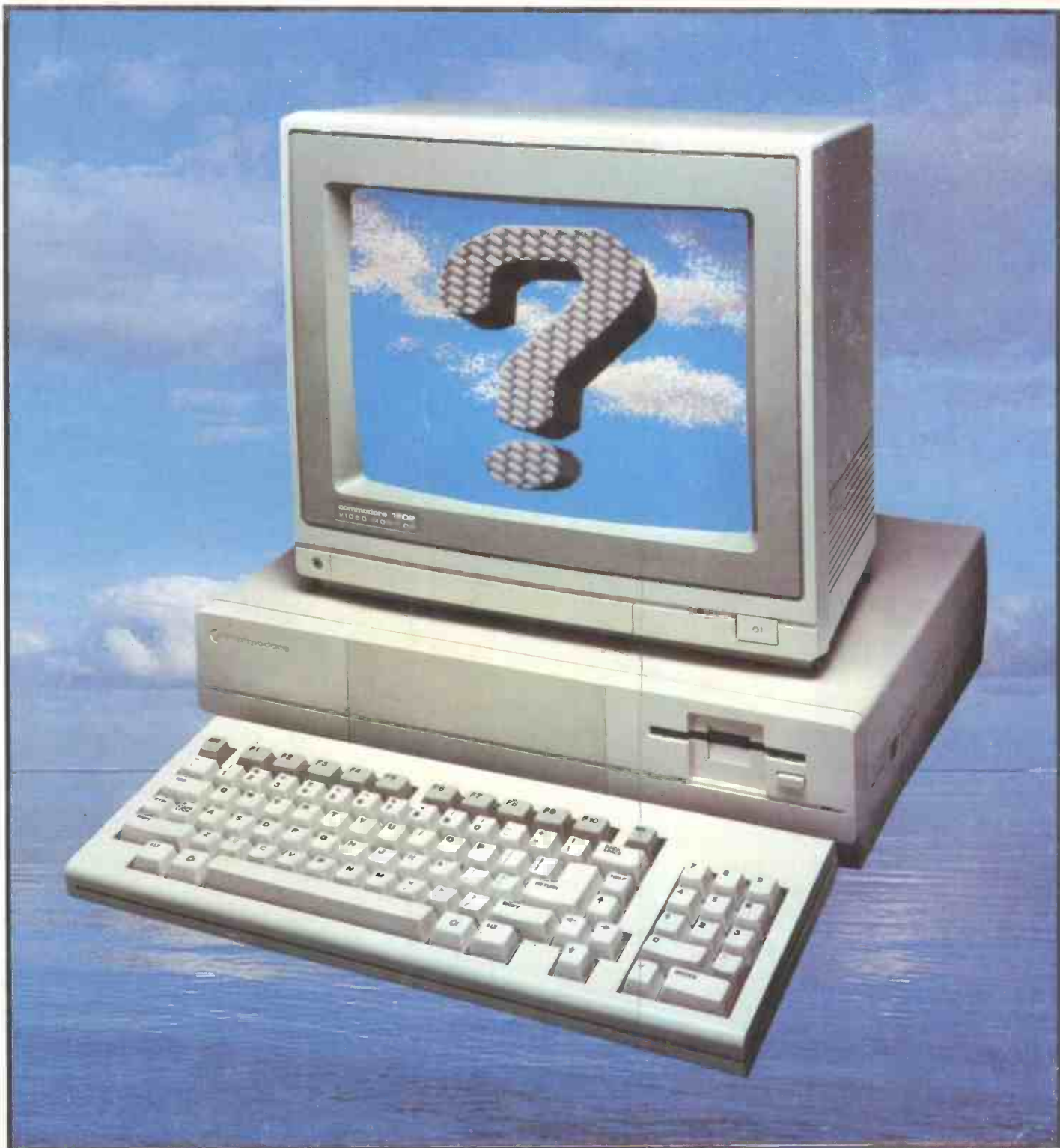

THE BIGGEST SPLASH YET?
Exclusive: Commodore's Amiga tested

NEW

From Silicon Valley Products

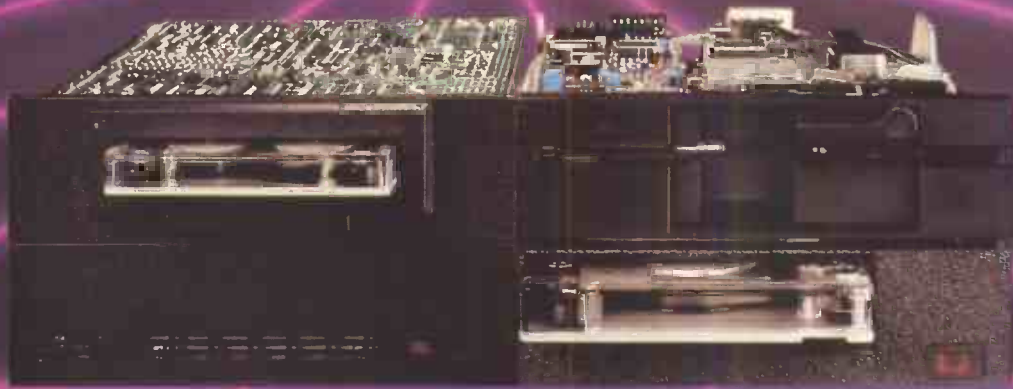

MICRO-BOOSTERS

Upgrade your PC[†], XT or AT up to 20 Mb from £599*

*This price applies to the IBM XT 10 Mb only.



Now you can boost the storage capacity of your IBM PC, XT or AT and also get fast back up for all your valuable information with these new MICRO-BOOSTERS from Silicon Valley.

Using half-height technology, these new MICRO-BOOSTERS can be installed internally, in place of the existing drives of your IBM PC, XT or AT, or externally as simple add-ons.



The range of drives includes hard disks from 10 Mb to 180 Mb, (over 20 Mb – full-height drive) a half-height floppy drive, a 10 Mb Tape Streamer and a 45/60 Mb. Tape Streamer which operates at a speed of 2.5 min per 10 Mb. All come with a full 12 month warranty.

Free on-site maintenance on all Silicon Valley installed Hard disks.

All at Unbeatable Prices

Just take a look at these prices for Silicon Valley Micro-Boosters:

XT 10 Mb. boosted to 20 Mb.	– £599
PC boosted to 10 Mb.	– £799
PC boosted to 20 Mb.	– £999

Tapestreamers

10 Mb. Tape Streamer	– £799
45/60 Mb. Tape Streamer	– £1,442

Half-Height floppy Drive	–£149
---------------------------------	--------------

† And most IBM Compatibles

IBM Complete Systems

If you would like to buy a complete and ready-boosted IBM PC from Silicon Valley, including 256K RAM, 1 x 360K DD., Mono screen, Keyboard DOS 2.1 the prices are only:
IBM PC plus 10 Mb. Micro Booster £2,500
IBM PC plus 20 Mb. Micro Booster £2,700

for further details or free demonstration contact us now – before the rush

DEALER ENQUIRIES WELCOME

All prices exclude VAT



164 Grays Inn Road,
 London, WC1X 8AX
Tel: 01 833 3391
 Telex: 262005 SILVAL G
NEW BRANCH*
 2-4 Paul Street,
 London EC2A 4JH
Tel: 01 247 8577

* Not IBM Authorised

FREE **ON-SITE MAINTENANCE**
 On all Silicon Valley Products installed hard disks.
WARRANTY
 On all Silicon Valley Micro Boosters

Everyone can benefit from Effective Micro Training at Digitus

NEXT COURSE DATES

Introduction to Personal Computers

Provides a basic understanding of microcomputer hardware, software and peripherals. Establishes the criteria for selecting and using micros. Explains the rudiments of programming. 1 day. £105.

Aug 12

Introduction to DOS

Provides a concentrated introduction to PC/MS DOS. Also reviews hardware components and popular applications. 1 day. £105.

Aug 5

Lotus 1-2-3

A workshop course with advice on the design of worksheets and on solving practical problems. 1 day. £105.

Aug 6

Advanced Lotus 1-2-3

Builds on existing Lotus 1-2-3 skills, presenting information on database, statistical and file functions. 1 day. £105.

Aug 22

1-2-3 to Symphony

A practical conversion workshop for existing 1-2-3 users. 1 day. £105.

Sep 9

Introduction to Symphony

Provides a concentrated introduction to the main elements including spreadsheeting, graphics, information management and "managers" wordprocessor. Teaches the basic skills needed to use these features. 2 days. £210.

Aug 12

Symphony Workshop

Consolidates basic skills and teaches advanced features including building systems with the integrated package and command language. 2 days. £210.

Sep 12

Spreadsheeting with SuperCalc

A workshop course with advice on the design of worksheets and on solving practical problems. 1 day. £105.

Sep 23

Spreadsheeting with Multiplan

A practical workshop course on this popular spreadsheet package. 1 day. £105.

Sep 18

Introduction to Framework

Teaches the basic skills to operate the spreadsheet, graphics, database and wordprocessing. 2 days. £210.

Aug 19

Information Management with Cardbox

A workshop course on design, applications and implementation. 1 day. £105.

Sep 27

All course fees are subject to VAT

Data Management with Delta

Teaches how to design, define and implement systems using this powerful data management package. 1 day. £105.

Aug 23

Working with dBASE II

Teaches the user how to build and enquire from files and generate reports. 1 day. £105.

Aug 7

Programming with dBASE II

Teaches programming using the dBASE procedure language and also file design and indexing. 2 days. £210.

Aug 8

dBASE II Workshop

Builds on existing dBASE skills to teach the more advanced use of the procedure language and the practical application of all these facilities. 2 days. £210.

Sep 5

Working with dBase III

A practical introduction, including building and using files and creating reports and indexes. 1 day. £105.

Aug 28

Programming with dBase III

Involves building commercial files using the procedural language, and covers the creation of menus, enquiries and reports. 2 days. £210.

Aug 29

Wordprocessing with WordStar

A practical workshop course which teaches basic skills. 1 day. £105.

Aug 7

WordStar Workshop

A workshop to consolidate basic skills and teach advanced commands. 1 day. £105.

Aug 8

MailMerge

Efficient use of WordStar for mailing using MailMerge. 1 day. £105.

Aug 9

Wordprocessing with Multimate

A practical workshop course which teaches basic skills. 1 day. £105.

Aug 19

Multimate Workshop

Covering advanced features of Multimate, providing an ideal follow-up. 1 day. £105.

Aug 20

Wordprocessing with DisplayWrite 2

A practical course teaching basic skills on this increasingly popular IBM-oriented wordprocessing package. 1 day. £105.

Aug 15

SunAccount

A practical course for both experienced and new SunAccount users. 2 days. £210

Aug 1

DisplayWrite 2 Workshop

A practical workshop consolidating basic skills and exploring advanced features e.g. maths function, paragraph merging etc. 1 day. £105.

Aug 16

Fundamentals of BASIC

Develops the first principles of BASIC programming so that you can produce programs on a microcomputer. Gives practical hands-on experience of micros. 2 days. £210.

Aug 13

Improve your BASIC

Brushes up and improves BASIC programming technique; introduces sophisticated methods of file design, data organisation, access methods and control. Examines software tools. 2 days. £210.

Aug 15

COBOL for Programmers

A practical introduction for non-COBOL programmers giving a good grounding in all aspects of the language in a commercial environment. 3 days. £375.

Aug 27

Communications

Introduces the techniques of communicating between micros, from micros to peripherals and from micros to mainframes. 1 day. £125.

Aug 30

UNIX

An introduction to the facilities of the UNIX multi-user operating system, including the file system, shells and editors, and a review of the problems of system management. 3 days. £375.

Aug 19

The C Programming Language

A tutorial on the main features of the C language, with extensive practical sessions on a multi-user system. 2 days. £250.

Sep 9

"C" Workshop

More advanced C programming skills. 2 days. £250.

Sep 12

MANAGING OFFICE AUTOMATION

A two-day seminar to prepare management to devise and implement a successful office automation strategy. It addresses key issues, presents current examples and provides the opportunity to discuss important aspects related to the needs of your organisation. Next seminar: September 17-18.



Send to, or phone:
The Training Administrator, Digitus Ltd.
Lading House, 10-14 Bedford Street,
Covent Garden, London WC2E 9HE
Tel: 01-379 6968 Telex 27950 ref 3005

From

Company

Address

Please book places as follows or send me more details

Course Date Places

IN-COMPANY TRAINING

Digitus provides courses tailored to the needs of individual companies, from seminars for management to detailed training for office and professional staff. Courses can be held on company premises, or at the Digitus Training Centre. Contact the Training Administrator for full details.

CONTENTS

Vol 8 No 8 August 1985



Cover story begins page 136. Computer-aided montage by Latent Image

REGULARS

- | | |
|---|---|
| NEWSPRINT 110 | SCREENPLAY 208 |
| Guy Kewney keeps his wary eye on the micro industry, and talks to Clive Sinclair about life with Robert Maxwell. | Reds are under the bed in The Fourth Protocol and there's fairies in the forest in Elidon. Armchair sportsmen can try their hand at International Basketball and On-Court Tennis, and there's Chipwits, the educational robot. |
| YANKEE DOODLES 124 | TJ'S WORKSHOP 212 |
| The Big Country explored by David Ahl. | Hints and tips enabling you to make the most of your micro. |
| SUBSCRIPTIONS 128 | SUBSET 216 |
| Give your postman exercises in weight-lifting by subscribing to PCW. | Rising to the challenge of machine coding the 68000. |
| LETTERS 130 | COMPUTER ANSWERS 218 |
| Praise taken and warnings given, courtesy of our readers — plus our Bludners sorted out. | Simon Goodwin is the man with the solutions to your problems. |
|  | NETWORKS 220 |
| | Peter Tootill continues the saga of Prestel and updates his list of bulletin board numbers. |
| BANKS' STATEMENT 134 | END ZONE 222 |
| Could 32 be brain-numbing, 16 overkill and eight all you need? Martin Banks wonders if there's too many bits around these days. | Touchdown for Transaction File, Diary Data, Leisure Lines, Numbers Count, Computer Chess and ACC News. |
| BIBLIOFILE 206 | PROGRAM FILE 232 |
| The best in books — David Taylor is our man in the reading jacket. | To go with the Teach Yourself Logo series we have a turtle graphics language program for the BBC this month, and a Logo database, so get typing and try out your new-found knowledge. There are games for the Commodore 64, Spectrum, QL and the MSX range. |
| | ADVERTISERS' INDEX 278 |
| | Who's where in this issue. |
| | CHIPCHAT 280 |
| | Sid goes Bonkers, Linda reveals nearly all, and Sir Clive gets converted on the road to Oxford — read all about it in <i>The Maxwell</i> . |

Founder Angelo Zgorelec Editor Graham Cunningham Production Editor Ginny Conran Acting Production Editor Kirstie Rogers Sub Editor Lauraine Danker Business Computing Editor Peter Bright Staff Writers Nick Walker, Stephen Applebaum, Owen Linderholm Consultant Editors David Tebbutt, Dick Pountain Editorial Secretary Tracy Dear Art Director Peter Green Assistant Art Editor Paul Ballard Typesetters Meadway Graphics 198 Victoria Road Romford Essex Sales Director John Cade Publisher Tony Harris Publishing Manager David Mankin Group Advertisement Manager Duncan Brown Advertisement Manager Bettina Williams Assistant Advertisement Manager Melanie Romiszowska Sales Executives Claire Barnes, Steve Corrick, Jerka Harrington, Tony Keefe, Christian McCarthy, David Morgan, Isabel Middleton Advertisement Assistant Nicola Hall Advertisement Production Gerry O'Sullivan

BENCHTESTS & REVIEWS

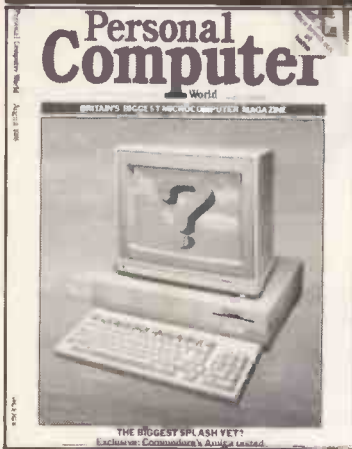

COMMODORE AMIGA 136

Trying to curb your enthusiasm when reviewing a new machine can be difficult — particularly when that machine's specification is as high as the Amiga's. This could be a rich man's ideal games machine and offer a new level in high-performance business computing. Read the review and see if you agree with our conclusions.

KAYPRO 286i vs COMPAQ DESKPRO 286 152

While supplies of IBM's PC/AT are still slow, the clone makers are starting to get in gear. Peter Bright compares the first two PC/AT-compatible desk-top contenders.

ZERO 2 166

Turtle robots come out of their shells, courtesy of Intergalactic Robots.

PAPERBACK WRITER 174

This marks the return of Adam Osborne with a range of applications packages including this word processor — and he's still making sure that the price is right.

OF MICE AND GRAPHICS 176

Mouse-driven graphics packages are breaking out at home — Stephen Applebaum pulls down the menus and picks his palettes.

JAZZ 180

Does this integrated business package for the Macintosh have more going for it than the kind of title headline writers dream of? Peter Bright picks his way through the pre-launch hype.

WINDOW SHOPPING 184

How much is that operating environment in the window? Nick Walker puts GEM, Windows and TopView through their paces.

DATAFLEX 202

Is Dataflex part of the answer to the problems of multi-user systems? Kathy Lang assesses this database package.

FEATURES

FRANKLY FUNCTIONAL 148

Functional programming represents the next stage on from using a structured approach. David Elworthy puts theory into Basic practice.



REAL LIFE 160

Computer simulation need not be a daunting task. Mike Pidd explains how it can be like using a computer to play serious games.

NEW FOR OLD 168

How — and whether — to make the move from the familiarity of WordStar to the friendliness of WordStar 2000.

ALL IN THE CHIP 190

A detailed look at one of the advances in Japanese research — a compiler on a chip that promises to do the job 1000 times faster than software-based systems.

VISICODE REVISITED 194

How to receive television-transmitted software. This month, Amstrad and Spectrum users take their place alongside Commodore 64 and BBC owners.

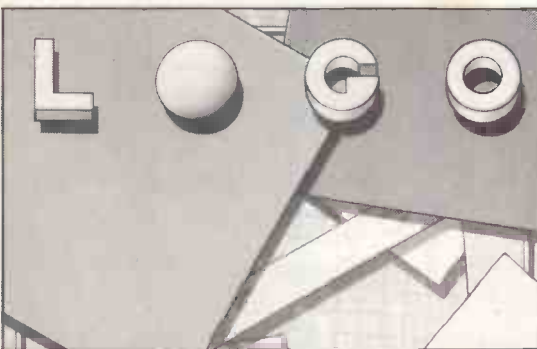

LOGO LISTS 198

Harvey Mellor continues this Teach Yourself series with a look at Logo list processing.

ATT PRICE GUARANTEE

PROVIDE A WRITTEN LOWER QUOTATION FROM AN AUTHORISED DEALER WITHIN 7 DAYS OF PURCHASE AND THE DIFFERENCE WILL BE REFUNDED!

CALLERS BY APPOINTMENT ONLY

SPECIALISTS IN EXPORT

APPLE

MAC 512K	1880*
MAC 128K	1345
MAC DRIVE	256
IMAGEWRITER 10"	285
IMAGEWRITER 15"	395
ACC. KIT	30

*CALL FOR SPECIAL MAC SYSTEMS OFFER
LIMITED PERIOD ONLY

OLIVETTI

M24 2x360 DRIVES	1462
M24 10Mb	2567
M21 2x360 DRIVES	1322
M21 2x720 DRIVES	1644

APRICOT

★ £1000 OFF ★
PORTABLE ~~1795~~ 795

PC 2 x 720K + Mon	1500
PC 2 x 315K + Mon	1350
XI 10Mb + Mon	2150
POINT 32 10Mb	2395

SOFTWARE

JAZZ
NOW AVAILABLE
FOR 385
CALL FOR
UP TO
40% OFF

PRINTERS

SPECIAL
HEAVY DUTY RICOH
DAISY WHEEL PRINTER 480
TOO MANY TO LIST —
CALL FOR PRICES

SYSTEMS

DESIGNED FOR YOUR
REQUIREMENTS
INCL BACK UP!

IBM

PRICES NOW
SLASHED

RING NOW: 01-729 7033

ATT

(T.I.) INDUSTRIAL UNITS
STANWAY STREET LONDON N1 6RY
TEL: 01-729 7033 Telex: 296119 DATALEX G

EPSON QX16



**YOU CAN GET ONE
AT A SUPER PRICE**

01-337 4541

from

01-337 4541

CONCORDIA COMPUTERS

6 CENTRAL ROAD, WORCESTER PARK
SURREY KT4 8HZ

AMSTRAD INTERFACES

THIS IS NOT JUST A MODEM, BUT A COMPLETE SYSTEM. NOTHING ELSE TO BUY

★★ MODEM ★★
★ £153.00 ★

Incorporating serial and parallel interfaces, to allow software control of all functions, each feature controlled from basic with the bar commands. Call from m/c or on entering bar modem all controls are menu driven for ease of use, bell/ccitt standards 300/300 800 1200 1200/75 75/1200 full and half duplex. Auto dial and auto answer contact bulletin boards, prestel compatible, software bulletin on its own sideways Rom. Unique panel display, it displays what the modem is doing, mode of operation, and digits when auto dialing, standard B.T. plug connector. *Note this modem is not B.T. approved.*

★★ SIDEWAYS ROM ★★
★ £26.05 ★

The unit holds 4 Roms. Each can be 2, 4, 8 or 16K in size incorporating a device to allow slower Roms to be used less than Amstrad suggested 200, that means cheaper Roms, free utility Rom with every unit.

RS232

Communicate with your modem
Talk to other computers
Use serial printers
Split Baud rates
Standard 25 way 'D' connector
£39.96

PARALLEL PORT

Make that Robot move
Control electrical appliance
Twin 8 bit ports
Operates direct from basic
2 x 14 way speedblock connectors
£22.57

8 BIT PRINTER PORT

Make use of that 8 bit printer
Allows character codes
Above 127 (ie 0 to 255)
Plugs in between centronics
Port and printer cable
£17.35

All units are cased and have through connectors
★ Please add VAT ★

15 Hill Street, Hunstanton, Norfolk PE36 5BS
Tel: (04853) 2076

COMPUTER HARDWARE & SOFTWARE



ELECTRONICS

Honeywell Compuprint: the printer every computer would love to have.



34 CQ Printer: standard serial and parallel interfaces. IBM, Epson and Diablo protocols. Fast draft speeds (up to 270 cps) and superior correspondence quality printing selectable at the touch of a button. Integrated single sheet feeding and automatic sheet feeder option.

Connectable to all the leading makes of computer such as IBM, Televideo, Apple,...

Everyone has a right to seek out perfection. And every Honeywell Compuprint 34 CQ

in concept and design, has been subjected to the most severe technological evaluation in the search for perfection. It has experienced

every stress possible to confirm its durability, product quality and reliability. It goes without saying that a Compuprint 34 CQ can print in different fonts and characters.

The most demanding tests have proved its flexibility and quiet operation and its compatibility with any computer. That's why everyone would love to have such a printer. For further information please contact:

Honeywell Information Systems Italia
Maxted Road, Hemel Hempstead
Herts HP2 7DZ Tel. 0442/42291
(ext. 4546-4320-4547) Tlx 82413

Together, we can find the answers.

Honeywell

Honeywell Information Systems Italia

DESIGNED WELL
BUILT WELL
HONEYWELL.

COMPUTER PRINT HONEYWELL
LA STAMPANTE CHE TUTTI
I COMPUTER VORREBB...

COMPUTER HONEYWELL
L'IMPRIMANTE QUE TOUS LES
ORDINATEURS AIMERAIENT POSSÉ...

COMPUTER HONEYWELL
MÄTRADRUCKER DER DRUCKER,
DEN ALLE COMPUTER GERNE HÄTTÉ...

INTRODUCING...THE TULIP SYSTEM PC SERIES.THERE CAN BE ONLY ONE WINNER IN THE PC COMPATIBLES RACE.



More Dealers Wanted for our complete product-line. Please contact: **LONDON:** David Rush LTD 01-363-3746 **WEST MIDLANDS:** Pearl Computers LTD 05432-22976 **EAST MIDLANDS:** Contraplex Computers LTD 0332-360571 **EAST ANGLIA:** Moonraker Computers LTD 0603-610413 **SOUTH WEST:** Newport Technical Services LTD 0272-878312 **TRAVEL AGENTS:** Status Travel Systems 021-6325277

Records are made to be broken they say – but this is easier said than done. It is possible only after much preparation and practice.

That is why CompuDATA did not join the rush to enter the race to introduce the first personal computer on the market.

We carried on quietly – developing two personal computers which could enter the second race – with no handicap.

And now patience – as always – has been rewarded and two personal computers, the Tulip PC advance and the Tulip PC compact, developed by CompuDATA, are ready to compete. The quality and price of these computers put them well ahead in the field for the performance award.

They have special features to be found in none of their rivals in the same class.

As we said, the PC advance and the PC compact may not have been the first, but they certainly are the best.

	TULIP SYSTEM PC ADVANCE	TULIP SYSTEM PC COMPACT
Microprocessor	8086	8088
Clock	8 Mhz	8 Mhz
Arithmetic co processor (opt.)	8087/8 MHz	8087/8 MHz
Memory (standard)	128 Kb	128 Kb
Expandable upto	640 Kb	512 Kb
Graphic formats (7 colors)	320/640x200	320/640x200
(monochrome)	640x200/400	640x200/400
Display formats	80x25 monochr 40/80x25 color	80x25 monochr 40/80x25 color
International character sets	11	11
Interface: Keyboard	IBM comp. (2)	IBM comp. (1)
Parallel I/O	Centronics comp.	Centronics comp.
Serial I/O	RS 232 compatible	RS 232 compatible
Floppy disk contr.	2 drives	2 drives
Expansion bus for IBM comp. boards	3 slots	4 slots
Expansion slots I/O	piggy backed	piggy backed
Lightpen	TTL compatible	TTL compatible
Real time clock	yes	yes
Clock/calender with battery		
back-up	yes	no
Monitor EPROM	16 Kb	16 Kb
Floppy disk drives 40 trk	2x360 Kb	2x360 Kb
80 trk (opt.)	2x720 Kb	2x720 Kb
Hard disk drives (optional)	1x10 Mb 1x32 Mb	1x10 Mb 1x32 Mb
Operating system (standard)	MS-DOS 3.1	MS-DOS 3.1
Programming languages (standard)	GW-BASIC	GW-BASIC
Optional add-on units	tape back up 10 Mb + tape 32 Mb + tape	tape back up 10 Mb + tape 32 Mb + tape
Transportable set	yes	no

CompuDATA COMPATIBLES available from £1,150,-.



CompuDATA B.V. Hambakenwetering 2 5231 DC 's-Hertogenbosch, The Netherlands Tel.: +31 73 42 20 45 Telex: 50316 cdata nl

CHANNEL ISLANDS: A.G.L. Computers 0534-30662 IRELAND: Datatronics Systems LTD, Dublin 6 965859/978856

'We would like to appoint dealers for our equipment. Please contact CompuDATA Head Office and ask for the export department'.

your next product

Right now you are probably planning your next product. A workstation. An intelligent terminal. A network file server. Or perhaps an embedded control system.

Whatever your application, benchMark 186 is the computer you need never design.

Because we've done it for you.

It is so resourceful, you are only bound by your imagination. It is blessed with an elegant architecture and abundant computing power. Its superb high resolution graphics and text display are unheard of in this price range. Yet it only costs around £750 in quantity.

And while we are taking care of quality and the production, you can be spending more on your new application.

But our support does not end there.

We also provide you with an excellent software development environment. With many languages, libraries and tools to match. So you need not invest in expensive development systems.

We even throw in a multitasking real-time executive, and a concurrent debugger with each board we sell.

And if you are not really looking forward to interfacing that laser printer, ask us. We can probably do it for you. We may even go out of our way to customise the board if your order is a large one.

We can also save you precious time with our training programme. In hardware. Software. Or both. Servicing should not be a worry either. With our specially designed tools we will show you how to test your product quickly.

Because we know your success is ours, we work harder when you do. So before that important exhibition you can contact us round the clock on a special hot-line we provide.

And as we are a British company we are never more than a short journey away. If it cannot be said over the phone, we will come to you to help.

At benchMark we pledge loyalty to our customers. In fact, convince us, and we may even give you an exclusive deal in your immediate field.

So if you are interested and want to get on board fast, contact us.

We will talk to you.

benchMark Technologies Ltd
11 Victoria Road, Kilburn
London NW6.
Tel: 01-624 5681

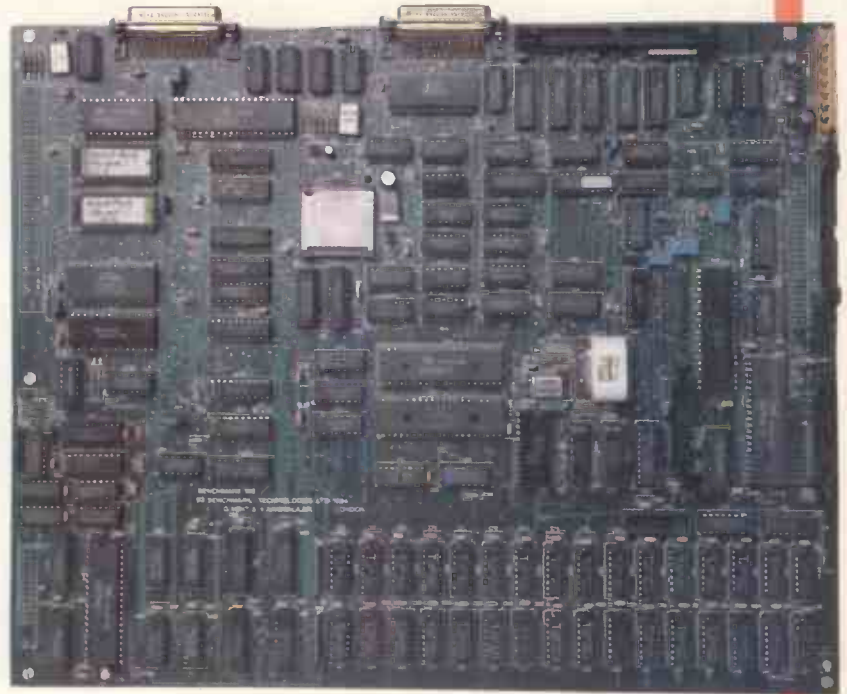

benchMark 186 single board computer for OEMs

HARDWARE SPECIFICATIONS

CPU	80186 6 or 8 MHz
EPROM	32K
VIDEO	RAM128K to 1M on board 16K separate character buffer upto 1280 x 800 pixels bit resolution upto 160 x 60 characters text resolution upto 16 x 32 bits character resolution Fully bit mapped graphics Soft character set of upto 2000 characters Full attributes and soft scroll
COMMUNICATIONS	Composite or direct video drive Two full RS232 channels with independent baud rate generation and with loop-in loop-out capability Asynchronous and synchronous protocols
FLOPPY	Controller for a upto 4 double sided, double density 8.5 25 or 3.5 inch drives.
HARD DISC	On board SASI bus and support for 2 hard disc drives. (fixed - removable).
KEYBOARD	Parallel or serial keyboard interface
PRINTER	Centronics compatible parallel keyboard interface
REAL-TIME CLOCK	Battery backed clock with time, calendar and alarm functions.
CMOS RAM	50 bytes of battery backed RAM
IEEE 488	Full electrical implementation of the IEEE 488 instrument control bus
DMA CHANNELS	2 floating DMA channels. Most peripherals can be DMA and/or interrupt driven
TIMER COUNTERS	3 uncommitted timer counters with external trigger and clock inputs
EXPANSION BUS	Fully buffered expansion bus with access to interrupts, DMA channels and TIMERS
ADD-ONS	8087 floating point module (November 84) Proximity string correlator module (January 85).
PCB	CAD CAM 4 layer PCB (330mm x 280mm)
SOFTWARE	
MS-DOS 2.11	Multitasking implementation of MS-DOS operating system The operating system itself also runs as a task
'C' COMPILER	Specific support for the Lattice 'C' compiler and tools with benchMark specific libraries: benchMark multitasking real-time executive benchMark concurrent debugger benchMark VT220, VT100, VT52 emulation. benchMark signature analysis stimuli benchMark hardware definition libraries

MS-DOS is a trademark of Microsoft Inc.
Lattice is a trademark of Lattice Inc.
benchMark 186, bRTX, bCD, bVT220, bSAS, bDEF are trademarks of benchMark Technologies Ltd
Prices and specifications are subject to change without notice

benchMark

TECHNOLOGIES • LIMITED

Have you put a **CLIP** in your Winchester?

CLIP — Compressed Library Interchange Program

CP/M CP/M-86 PC DOS MS DOS £105.00

- **Backs up a Winchester on to floppies.**
- **Compresses text or data to less than half size.**
- **Large files can span multiple discs.**
- **Selective backup or retrieval, on an inclusive or exclusive basis.**

CLIP has no equal in reputation, convenience, power or economy.

EFFORTLESS BACKUP

You can save commands for later use, or type commands directly.

CLIP has its own menu, with seven prepared commands. Customise the commands if you wish, or edit the menu text with a word processor. Or keep the standard forms. All your housekeeping — save/restore/review — by pressing two keys.

CLIP comes standard with Winchester systems supplied by **Olympia, Cifer Systems, Research Machines and Philips, British Telecom** And is highly recommended by other major manufacturers



KEELE CODES LTD

University of Keele, Keele, Staffordshire, U.K. Tel: **(0782) 629221** Telex: **36113**

All prices excl. VAT, post free in U.K.
Most popular disc formats from stock.

ALL-TIME CP/M MICROCOMPUTER SYSTEM BARGAIN!

Fantastic bulk purchase of a major European manufacturer's entire stock of this top-quality machine enables us to retail it at far below its manufacturing cost. ALL FEATURES LISTED are INCLUDED as STANDARD:

- COMPLETE with EITHER single or double (as illustrated) TEAC half-height 5¼" double-sided, double-density floppy disc drives. Formatted capacity: 320Kb per drive.
- 4 MHz Z80A CPU
- 64Kb RAM (in 4164 chips)
- 28Kb EPROM containing monitor & MICROSOFT BASIC
- CP/M Version 2.2
- 80 × 24 display with colour block-mode graphics
- Exceptionally high quality styled keyboard with numeric keypad & 6 function keys



- Centronics parallel interface
- RS232/V24 serial interface selectable 300-9600 Baud
- UHF Modulator for TV & composite video output
- ROM port. (A Word-Processor ROM is available at £69+VAT)
- 6 month full guarantee & option to return within 14 days if not absolutely delighted

PRICES (monitor not included): With DUAL floppy: **£347.00 (£399.05 incl. VAT)** With SINGLE floppy: **£250.00 (£287.50 incl. VAT)**



CARRIAGE: **£9.50** (incl. VAT) Visa & Access accepted



Available ONLY from:

COMPUTER APPRECIATION, 16 Walton Street, Oxford OX1 2HQ. (0865) 55163 TELEX: 838750
MATMOS Ltd., 1 Church Street, Cuckfield, W. Sussex RH17 5JZ. (0444) 414484/454377 or (0444) 73830

JAZZ & MACINTOSH

Jazz 512K
£399 Fat Mac **£1895**

THE PORTABLE



HP 110

HP 110: Uses industry standard operating system, MSDOS and is made more friendly with HP's PAM which gives easy access to the program packages. Lotus 123 and Memomaker are built into ROMs giving spreadsheets, simple graphics and note making — making it a useful tool for the executive on the move.

£2595
 List price £2995

HEWLETT PACKARD CALCULATORS

HP 11C	£63	Printer	£call
HP 15C	£99	Cassette Drive	£call
HP 12C	£99	HP 75C	£599
HP 16C	£99	Visual pack	£119
HP 41CX	£173	Text Formatter	£78
HP 41CV	£249	Data Com Pac	£144
Card Reader	£145		

HP-150 II
 £call

H-150B

HP-150: dual 720kb 3 1/2" disk drive, 256kb RAM, keyboard. High resolution (512x390) monitor.

£2299

PRINTERS

HP Think Jet

Fast 150 CPS, quiet 50 dBA(A). High print quality 11x12 character cell, 96x96 (192) dots per inch. Disposable print head. Pin and friction allows you to use single sheets as well as fanfold paper.

£399

Lazerjet Printer

A silent but speedy masterpiece. 300 CPS for best letter quality. Unbeatable resolution whether it is text, charts or diagrams and it's compatible with the IBM PC and wordstar, Lotus packages etc.

£2950

Plus 12 month on site warranty

OLIVETTI M24

10 MB + 640K Ram. **£2399**
 20 MB + 640K Ram. **£2699**

OLIVETTI M24

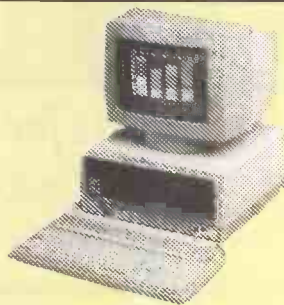

PC. It uses the full 16 bit 8086 chip running at 8MHZ, which makes it more than twice as fast. It combines monochrome text and colour graphics, offering a 640 by 400 pixel higher resolution mode. The quality of the screen is excellent. The M24 has 128k of RAM (can be up graded to 640k RAM), serial and parallel ports, clock/calendar and reset button and is cheaper than an IBM having the same specifications.

M24: Not only is it stylish but technically superior to the IBM

£1499

OLIVETTI M21 PORTABLE PC



serial RS232C port and two lockable 360K MFD 5.25in floppy disc drives. It includes a built in clock/calendar and LED indicator. The Olivetti M24 has a better screen than the IBM and runs more than twice as fast as either IBM or COMPAQ.

M21: It is self contained with an Intel 8086-2 chip, 128k of RAM, a 9in amber screen with brightness and contrast controls, colour graphics adaptor, printer adaptor,

£1499
OLIVETTI

EPSON COMPUTERS & PRINTERS

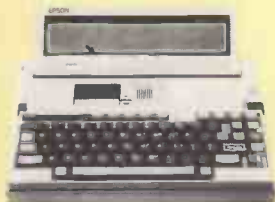

EPSON PX-8

PX8: Uses CPM operating system and has an 8 line by 80 column LCD screen. CPM 2.2, Microsoft Basic, Wordstar, and Cardbox+ are built in ROM, with 64K RAM available

£795

HX 20

PRINTERS



FREE INTEXT WORD PROCESSOR

£395

FX 80	£349
FX 80 F/T	£259
FX100	£499

P80X	£250
P40	£87
P80	£159
Epson colour printer	£560
Epson Plotter	£399
Epson LQ 1500	£call
OKI Microline 93	£464

Cannon PW1080A	£289
Canon PW1056A	£419
Panasonic Printer	£299
Silver Reed EX550	£489
Silver Reed EX500	£279

SONY MODEL 10 Word Processor



from **£2595 inc Printer**

The Model 10 is probably the smallest WP system on the market and incorporates all the easy to use features of SONY WP. Sony word processing opens up a whole new world of office efficiency taking in text editing, text processing, arithmetic calculations, records management, communications and data processing.

Simplicity is the central feature of the Model 10 system. The

High resolution screen, displaying black characters on a light blue background, ensures visual clarity and comfort. Embolding, underlining, centering and indentation can all be seen before printing. The keyboard is easy to operate designed specifically for typing. The SONY PAL (personal audio learning) system enables the secretary to use the Model 10 quickly and without fuss. Please call for demonstration and price.

Tasha
 Business Systems

191 Kensington High Street, London W8

Authorised Dealer

APPLE — COMMODORE — HEWLETT PACKARD — EPSON — SONY — OLIVETTI

01-937 8529

Monday to Saturday 9.30-6.30pm

- TBS reserves the right to change advertised prices
- Add 15% VAT
- Goods subject to availability

Tel: 01-937 7896
 01-937 3366

Telex: 946240 (CWEASY G)

MBX No. 19001120



Which PRINTER FOR What COMPUTER?



Micro General the Specialists for Printer Selection

TRY BEFORE YOU BUY! Bring your micro to us and match with our range of printers – full workshop facilities available to iron out all technical hitches! CALL US FOR PRINT SAMPLES. TRADE or PRIVATE CUSTOMERS take advantage of our INTERFACING CONSULTANCY. INTERFACES & CABLES AVAILABLE FOR: ● SINCLAIR QL ● COMMODORE 64 ● OSBORNE ● MSX ● SPECTRUM ● SIRIUS ● EINSTEIN ● SAGE ● AMSTRAD and more!

MICROLINE



**MODELS FROM
£299 + VAT**

New Slimline design that's quieter, faster and superbly reliable: IBM PC Version available

- M182 par/serial/IBM 120 cps from £299 + VAT
- M192 par/serial/IBM NLQ from £399 + VAT
- M193 spec as 192 132 col from £549 + VAT
- NEW 84X5 Host of options: Bar coding, 30K buffer, MultiLingual, Scientific fonts, Qume/Diablo, Arabic.

3 print modes: Draft, Memo & Correspondence from £1295 + VAT

BROTHER



**FREE on site
maintenance in the UK.
For all business printers!**

Diablo compatibility. 3K Buffer 2 colour printing.

- HR15 13cps Serial or Parallel £375 + VAT
- HR15 keyboard £150 + VAT
- HR25 25cps Full width 16 1/2" £699 + VAT
- HR35 35cps Full width 16 1/2" £899 + VAT
- 2024L MATRIX NLQ 80cps, Draft 160cps, Diablo/Epson selectable £999 + VAT

SMITH CORONA



**from
£170 + VAT**

New printer range from the leading office equipment supplier. EPSON & IBM selectable

- FASTEXT 80 – 80cps ideal for home user – parallel – £170 + VAT
- D100 – 120cps – parallel – £220 + VAT (Serial interface for F80/D100 – £58 + VAT)
- D200 – 160cps Draft 80cps NLQ Serial & Parallel as standard – £299 + VAT
- D300 – 160cps, 132 col, NLQ 80cps Serial & Parallel interface standard – £495 + VAT

ZIYAD Paperjet Printing System

Collates paper and envelopes – **AUTOMATICALLY!**



£3750 + VAT

**Less than
\$4 day**

- Takes up to A3 paper
- Automatic position sensing on manual feed
- Integral Dual paper feeding
- Integral envelope feeder
- Automatic Address storage for envelope printing
- Diablo 630 or QUME Sprint Compatible

SUMMER SALE!

A Selection of well known printers offered at really low prices for a limited period only. **ALL EX-STOCK.**

- 80 cps 80 col parallel from **£135 + VAT**
- 120 cps 80 col parallel tractor feed from **£185 + VAT**
- 160 cps 80 col NLQ tractor feed from **£255 + VAT**
- 160 cps 132 col NLQ tractor feed from **£375 + VAT**

CANON Laser Beam Printer

Lighten up to **LASER PRINTING!**

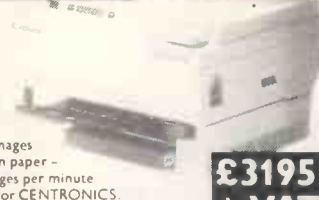

Crisp, clear images on plain paper – to 8 pages per minute RS232 or CENTRONICS.

£3195 + VAT

- Features include:
- Multiple character pitches in a line 10, 12, 13, 3, 15 CPI, P.S., etc.
 - Multiple font – maximum 15 fonts/page (internal font, font cartridge)
 - Character enlargement – doubling in two directions
 - Down loading of fonts

APRICOT F1

a full blown business micro

For the first time business user a genuine business machine with some amazing 'high tech' features. – See the Apricot's mouse execute previously complex tasks at a single key stroke, and the new Infra-red device means there's no cable connection to the keyboard, giving desk top planning a new meaning.

- 256K RAM 720 single disk.
- MS-DOS
- Rapid Display manipulation and special effects.
- Expansion and Outport facilities.
- Colour/Mono Monitor or VHF for your TV
- Extremely light (under 13lbs) – totally portable.
- Price includes SuperWriter, SuperCalc, & SuperPlanner software.
- Well over 1000 software packages now available.



**LEASE F1
from £7 per week
CALL FOR DETAILS
DEMO NOW**

MICRO GENERAL'S Pick of the Printers

Epson LX-80 Friction NLQ	£255.00	MP-165 160cps NLQ	£269.00
Epson LX-80 Tractor option	£20.00	JUKI 6100 Parallel	£325.00
Epson LX-80 Sheet feeder	£55.00	JUKI 6300 Serial or Par	£799.00
Epson FX80 160cps	£360.00	SILVER REED 16 Parallel 16cps	£256.00
Epson RX100 100cps	£390.00	SILVER REED 16 Serial 16cps	£279.00
Epson FX100 160cps	£499.00	SILVER REED 20 Parallel	£453.00
Epson LQ1500 200cps	£999.00	SILVER REED 20 Serial	£479.00
Canon PW1080A 160cps	£299.00	SILVER REED 36 Parallel	£799.00
Canon PW1156A 160cps	£419.00	SILVER REED 36 Serial	£825.00
Canon Pj1080A 7-COLOUR	£479.00		
Shinwa CPA-80P Par 100cps	£199.00	OKI HIGH SPEED MATRIX	
Shinwa CPA-80S Ser 100cps	£219.00	OKI 2350 Par. 350cps	£1755.00
Panasonic KC-P1091 120cps	£299.00	OKI 2410 Par. Graphics	£1875.00

PLOTTERS	CUMANA BBC DISK DRIVES	MICROVITEC 14 COLOUR MONITORS
EPSON HI-80 £400.00	CSX100 40T S/Slide 100K £109.00	1431-MS 452 PIXEL BBC £216.00
HITACHI 672 £495.00	CSX200D 10T D/Slide 200K £119.00	1451-MS 653 PIXEL BBC £260.00
	CSX400 BCT D/Slide 400K £166.00	1456-LI 653 IBM, Apricot £395.00
	CD200 2x40T S/Slide 200K £259.00	1456-DQ 653 Sinclair £239.00
	CD400D 2x40T D/Slide 400K £285.00	
	CD800S 2x80T D/Slide 800K £360.00	

● All prices exclusive of VAT.



(PCW 8)

Unit 25, Horseshoe Park, Pangbourne, Reading, RG8 7JW Tel: 07357 4466

DEALER/OEM ENQUIRIES WELCOME

■ Always call for the best possible price.



Access/Visa

PRINTERS

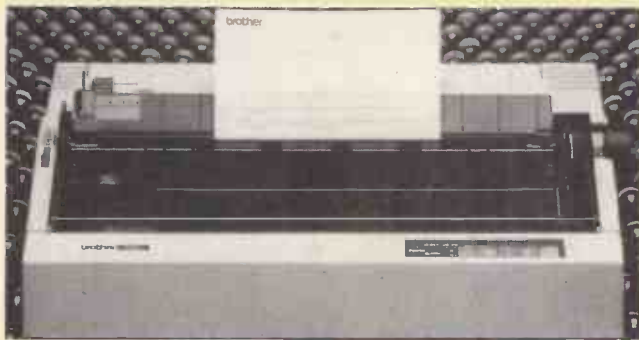

BROTHER 2024L

Letter Quality Dot-Matrix
Built-in tractor feed. High speed printing — 96 CPS (LQ Elite), 160 CPS (draft). Up to four carbon copies, bi-directional logic seeking.....£995

BROTHER HR35

Daisy Wheel Printer
Specially developed for the office that demands a high output of high quality printing. 7K bytes buffer, two-colour printing, super/subscript, 35 CPS, auto-underlining, bold printing.....£899

BROTHER HR15

A superb printer offering high quality daisy wheel print, for an exceptionally low outlay. HR15 offers two-colour printing, shadow printing, proportional spacing, super/subscript and auto-underlining. 50 CPS bi-directional.....£375

BROTHER TC600

The Teleprocessor
The Brother TC600 puts a computer telecommunications system in your briefcase. Not a computer, just a portable electronic typewriter, but a fully functional telecommunications terminal that incorporates many of the advanced word processing features found on desktop models.....£415

BROTHER EP44

A feature loaded printer with 24 x 18 dot matrix print head, 4K memory, built-in RS-232C serial interface and 15 character display. Light, compact and battery powered — will fit into your briefcase.....£219

BROTHER M-1009

A compact high quality printer with full 80 column printing, 9 pin dot matrix head, 50 characters per second, built-in RS232C and Centronics, and bi-directional text/uni-directional graphic printing.....£199

BROTHER HR-5

This quiet and versatile thermal transfer printer delivers high definition 9 x 9 dot matrix text over 80 columns at 30 characters per second. Incorporates RS232C, Centronics or Commodore interface. Either battery or mains powered.....£149

BROTHER HR-25

An exceptionally high quality daisy wheel printer with a 3K buffer memory, bi-directional speed of 25 characters per second, 2 colour printing, super/sub script, auto underlining, text boldening and proportional spacing. Also text reprinting facilities £699

Macintosh & Jazz

Jazz £399

**Fat Mac
512K**

£1,899

LIST PRICE £2,599



LIMITED STOCK

APPLE CARD:
INSTANT CREDIT AVAILABLE
UP TO £2,500

128K
MAC
£1,399

ORDER LINE 01-937 8529



APPLE IIe Package



**Apple IIe 64K
Disk Drive
with controller**

£699

COMMODORE 64 Package

**Commodore 64 computer
C2N cassette recorder
International Soccer
Commodore Bag**

£175

1541 Disk drive.....£174
MSP801 Printer.....£160
Music Maker.....£33
Easy Script.....£39
Easy File.....£39

COMMODORE MODEM

- 1200/75 V23 Full Duplex
- Asynchronous operation
- B.T. Approved
- Components software held in 8k ROM

£85

Sargon III.....£42
Sargon II.....£17
Multiplan.....£99
Zork I.....£12
Zork II.....£12
Zork III.....£12
Simons Basic.....£39
Football.....£9
Lode Runner.....£30
Easy Calc.....£39
LOgo.....£56
Flight Simulator II (C).....£34
Flight Simulator II (D).....£42
Superbase.....£85

Macintosh Software

Multiplan.....£190	TK Solver.....£189	Macspell+.....£84
Chart.....£99	Word.....£179	PC to Mac.....£128
Basic.....£145	OMNIS1.....£149	Sargon III.....£42
Lotus Jazz.....£399	OMNIS2.....£295	Mind Probe.....£46
Copy-Mac.....£40	OMNIS3.....£399	Think Tank.....£124
MacPlot.....£90	PFS: FILE.....£call	Dollars & Sense.....£124
	DFS: REPORT.....£call	Mac Ledger.....£249
Clickart.....£34	Macforth.....£call	MacCash.....£149
Mac the knife.....£50	MacPascal.....£99	Typing Tutor III.....£50
Millionaire.....£51	MacProject.....£99	Wizordary 1.....£62
Zork I.....£36	MacTerminal.....£69	PFS File & Report.....£160
Zork II.....£42	Macdraw.....£99	DB Master.....£149
Zork III.....£42	Deadline.....£50	Desk Organiser.....£127
Witness.....£call		MacAttack.....£42
Hitchhiker's Guide to Galaxy.....£34		Helix.....£337
Music Composer.....£69	MacCalendar.....£call	Professional Bjack.....£64
Frogger.....£34	Trivia.....£34	Squire.....£60
Lode Runner.....£34	Funpack.....£34	Mighty Mac.....£84
MacGammon.....£call	Penstate.....£call	Animation Toolkit.....£62
Sargon III.....£42	Payroll.....£99	Vicom Com Package.....£149
		Modem.....£call
		MacVision.....£299
		Championship Boxing.....£33
		Mac Dust Cover.....£11
		Box of 10 3 1/2" Disks.....£39

APPLE IIC Package



**Apple IIC
Monitor IIC
Monitor Stand IIC**

£999

Tasha

Business Systems

191 Kensington High Street, London W8

Authorised Dealer

APPLE — COMMODORE — HEWLETT PACKARD — EPSON — SONY — OLIVETTI

01-937 8529

Monday to Saturday 9.30-6.30pm

- TBS reserves the right to change advertised prices
- Add 15% VAT
- Goods subject to availability

Tel: 01-937 7896
01-937 3366

Telex: 946240 (CWEASY G)

MBX No. 19001120

SAVE OVER £1000 ON THE OLIVETTI M24

OLIVETTI M24 with 640K RAM
OLIVETTI INTERNAL 10MB HARD DISK
OLIVETTI MONITOR
OLIVETTI KEYBOARD
MS — DOS

RRP	£3523
OUR PRICE	£2500
SAVING	<u>£1023</u>

SIMILAR SUPERDEALS AVAILABLE ON ALL
OTHER OLIVETTI COMPUTERS AND PRINTERS

OLIVETTI M21 10MB PORTABLE with 128K RAM
OLIVETTI INTERNAL 10MB HARD DISK
1 x 360K DISK, INTERNAL MONITOR AND
KEYBOARD, MS — DOS, CARRY CASE

RRP	£2995
OUR PRICE	£2195
SAVING	<u>£800</u>

THE PROFESSIONAL CHOICE
COMPLETE SYSTEMS SUPPORT AND TRAINING AVAILABLE
FULL MANUFACTURER'S WARRANTY
NEXT DAY INSURED DELIVERY AVAILABLE



MAYFAIR MICROS

BLENHHEIM HOUSE, PODMORE ROAD,
LONDON SW18 1AJ

TEL: 01-870 3255 / 871 2555

We accept official orders from UK Government and
Educational Establishments. Mail Order and Export
Enquiries welcome. Callers by appointment.

SPACE-SAVING FURNITURE AT ACCOMMODATING PRICES

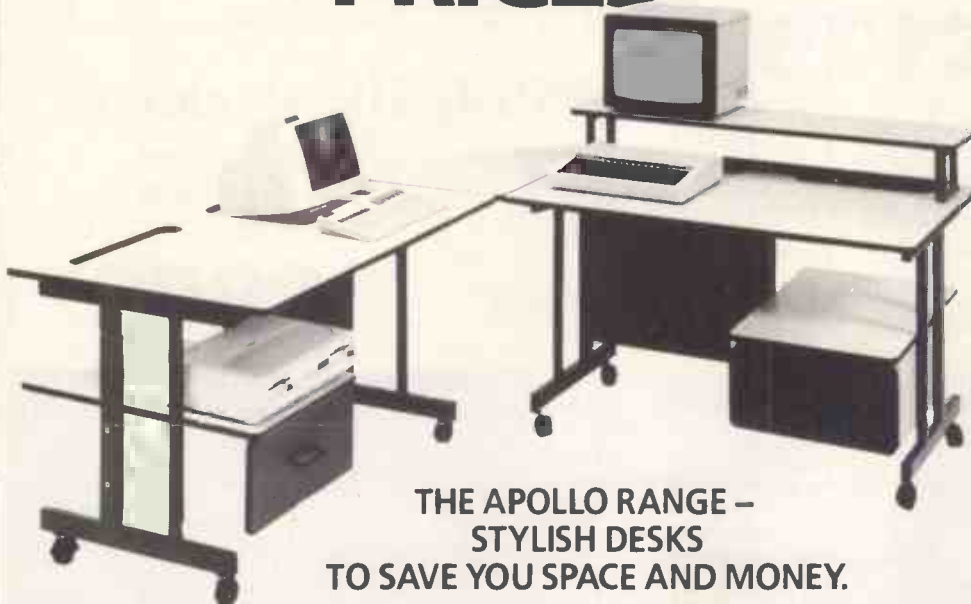

THE APOLLO RANGE —
STYLISH DESKS
TO SAVE YOU SPACE AND MONEY.

The Apollo business desk range from Opus Supplies brings a little high-style into the hi-tech age. But, with prices that start at only £100, these are desks designed to suit your computer system and your pocket.

Smart, modern, appearance combined with robust construction and practical styling ensures that Apollo desks will fit into any working environment; office or laboratory, classroom or sales area.

Sturdy steel underframes support shelving with scratch-resistant surfaces. The top shelf has sufficient room for a monitor and printer while below the lower desk top will accommodate your computer, hard or floppy disc drive and software.

You can choose left or right handed drawers for extra storage and all Apollo desk units are equipped with lockable castors.

Generous dealer, government and education discounts are available.

To: Opus Supplies Limited, 55 Ormside Way,
Holmehorpe Industrial Estate, Redhill, Surrey.

Please send details and brochure of the
Apollo business desk range (please tick)
or please send me the address of your
nearest stockists (please tick)

Name _____
Address _____

Telephone _____

Opus
Opus Supplies Ltd

PAM apricot

COMPUTERS

FOR YOUR FIRST COMPUTER SYSTEM

When you buy a system from PAM COMPUTERS that is not all you get, with each system comes advice, training and ongoing support. We will advise you on the right system for your business having first assessed what your needs are.

COMPLETE BUSINESS SYSTEMS

SANYO MBC555 with 2x160k disks	£1369
SANYO MBC555-2 with 2x360k disks	£1699
APRICOT PC with 2x720k disks	£2299
APRICOT Xi 10 with 10MB & 720k disks	£2999

FREE TRAINING

Prices include a matrix printer, everything you need to set up your first system, plus free software and 2 days on-site training. These systems include the SAGE integrated accounts package. All prices exclude vat.

ASK ABOUT OUR SOFTWARE PRICES NORMALLY 30% OFF RRP

Please **PHONE**
for more details about our systems

3 TENNYSON ROAD, ASHFORD, MIDDX TW15 2LN

(07842) 48972

SOFTSEL®

It's available from your local Softsel dealer.

ADELPHI BUSINESS COMPUTERS LTD.
25 TRINITY STREET, COVENTRY,
WEST MIDLANDS CV1 1FJ. TEL: (0203) 553944.

ADVANCED MICRO PRODUCTS
200 COURT ROAD, ELTHAM,
LONDON SE9 4EW. TEL: (01) 851 3311.

COLIN GRACE ASSOCIATES LTD.
CLIFTON MEWS, 62 HIGH STREET,
SAFFRON WALDEN, ESSEX CB10 1EE.
TEL: (0799) 22532.

COMPUTER CITY
78 VICTORIA ROAD, WIDNES,
CHESHIRE WA8 7RA. TEL: (051) 420 3333.

DEVERILL COMPUTER SERVICES LTD.
ITEC HOUSE, 34-40 WEST STREET,
POOLE, DORSET BH15 1LA. TEL: (0202) 684441.

FAIRHURST INSTRUMENTS LTD.
WOODFORD ROAD, WILMSLOW
CHESHIRE SK9 2L. TEL: (062) 553741.

GATE MICROSYSTEMS LTD.
ABBAY HOUSE, 10 BOTHWELL STREET,
GLASGOW, STRATHCLYDE G2 6NU.
TEL: (041) 221 9372.

MBS DATA EFFICIENCY,
MAXTED ROAD, HEMEL HEMPSTEAD,
HERTS HP2 7EL. TEL: (0442) 60155.

PACE SOFTWARE SUPPLIES
92 NEW CROSS STREET, BRADFORD,
W. YORKS. TEL: (0274) 729306.

PERSONAL COMPUTERS LTD.
220-226 BISHOPSGATE,
LONDON EC2M 4JS. TEL: (01) 377 1200.

PROGRAMS UNLIMITED
19 IMPERIAL HOUSE, KINGSWAY,
LONDON WC1. TEL: (01) 240 9006.

RAVEN COMPUTERS
28-32 CHEAPSIDE, BRADFORD,
YORKS BD1 4JA. TEL: (0274) 309386.

STIRLING MICROSYSTEMS,
1 PARK ROAD,
LONDON NW1 6XE. TEL: (01) 486 7671.

TASHA BUSINESS SYSTEMS
191 KENSINGTON HIGH STREET,
LONDON W8. TEL: (01) 937 7896.

THAMES VALLEY SYSTEMS
GREYS HOUSE, 7 GREYFRIARS ROAD,
READING, BERKS RG1 1NU. TEL: (0734) 581829.

UNITED SUMLOCK LTD.
36 KING STREET, BRISTOL,
AVON BS1 4DZ. TEL: (0272) 276685.

MusicWorks™
HAYDEN
SOFTWARE



SPECIAL AUGUST OFFERS

IBM PC	APPLE IIe & IIc
CORNERSTONE.....£300	BANK STREET WRITER.....£45
CROSSTALK XVI V3.5.....£115	CROSSTALK.....£125
DBASE III.....£365	DBASE II - Z80.....£285
FLIGHT SIMULATOR.....£50	FLASHCALC.....£60
FRAMEWORK.....£365	FLIGHT SIMULATOR II.....£35
GEM DESKTOP.....£35	FORMAT 80.....£95
GEM DRAW.....£95	HITCHHIKER'S GUIDE.....£25
HOME ACCOUNTANT PLUS.....£95	HOME ACCOUNTANT.....£45
INFOCOM ADVENTURES EACH.....£35	INFOCOM ADVENTURES EACH.....£35
LOTUS 123.....£330	MULTIPLAN APPLEDOS.....£75
MULTIPLAN.....£145	PFS:FILE.....£75
SAGE OPTIONS.....£105	PFS:REPORT.....£75
SIDEKICK.....£35	RETURN OF WERDNA.....£35
SUPERCALC 3.....£215	SIDEWAYS.....£35
SYMPHONY.....£460	SUPERCALC 3a.....£145
THINKTANK.....£120	THINKTANK.....£90
TURBO PASCAL.....£35	TK SOLVER!.....£190
WIZARDRY.....£40	TURBO PASCAL V3 - Z80.....£45
WORDSTAR 2000.....£335	WIZARDRY.....£35
WORDSTAR V3.4.....£195	WORDSTAR PROFESSIONAL.....£295
APRICOT	MACINTOSH
ABACUS.....£130	1ST BASE V2.0.....£125
ARCHIVE.....£180	CLICKART.....£30
BRAINSTORM.....£215	FACTFINDER.....£110
CARDBOX PLUS.....£250	TELEVISION.....£115
CHIT CHAT.....£95	HELIX 512K.....£245
DBASE II V2.41.....£285	INFOCOM ADVENTURES EACH.....£35
EASAL.....£130	JAZZ.....£375
FRIDAY!.....£130	MACACCOUNTING.....£295
INFOCOM ADVENTURES EACH.....£30	MICROSOFT BASIC V2.0.....£110
LOTUS 123.....£330	MICROSOFT CHART V2.0.....£110
MILESTONE.....£195	MICROSOFT FILE.....£145
MULTIPLAN V1.1.....£145	MICROSOFT WORD.....£145
OPEN ACCOUNT.....£300	MIGHTY MAC.....£60
QUICKCODE.....£135	MULTIPLAN.....£145
QUILL.....£130	MUSICWORKS.....£50
SUPERCALC 3.....£195	PFS:FILE & REPORT.....£120
SYMPHONY.....£460	STOCK PORTFOLIO.....£140
TURBO PASCAL.....£40	THINKTANK 512K.....£150
WORDSTAR PROFESSIONAL.....£360	TKI SOLVER.....£140
XCHANGE.....£360	WIZARDRY.....£40

ITS, 33 FOSCOTE ROAD, LONDON NW4 3SE
Tel: 01-430 2284 Telex: 21251 TICK G

MAIL ORDER ONLY: ALL PRICES EXCLUDE VAT
WIDE RANGE OF SOFTWARE AVAILABLE
AT LOW PRICES



Make it big with Musicworks.™

They had everything going for them. Good looks, determination and a great image.

But one thing stood between the Sydney Saunders Skiffle Duo and success in the music business. Talent.

But blessed with a good ear for a winner, Sydney laid out a few notes for Musicworks. A major development from Hayden Software.

FOR BUDDING HOLLIES EVERYWHERE

Even if you can't read a note, Musicworks enables you to compose music directly on your Apple Macintosh™, and hear the results instantly.

You compose on a seven-and-a-half octave grid. Just like the keys on a piano. As you put down your notes you hear them. All in the click of a mouse.

When you've got your latest masterpiece sounding just right, Musicworks transforms it into a musical staff, inserts the right

notation and prints it in a professional format which any musician

can follow. Even Sydney.

Now he can drum up any tune he likes. Change and edit notes. And then play back the whole melody whenever he wants.

THE FAB FOUR

Another feature that Sydney likes to harp on about is Musicworks' built-in instrument selection.

Use up to four at a time from a total of 10 or listen to each one selectively. Musicworks also comes complete with templates which guide you through playing classical and popular selections.

It's available from your local Softsel dealer. Along with over 2,600 other titles from over 250 publishers.

However there's still one slight hitch in Sydney's rise to stardom. He's been charged under the Trade Descriptions Act over the name of his latest album – "Sydney Saunders Entertains".

Musicworks – A sound investment.

SOFTSEL®

**The number one distributor of software.
In the world.**

Softsel Computer Products Ltd, Softsel House, Syon Gate Way,
Great West Road, Brentford, Middlesex TW8 9DD.

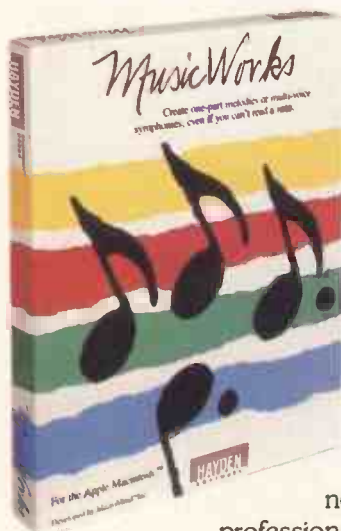

THE VICTOR RANGE

VICTOR VPC

VICTOR 9000

VICTOR VI

VICTOR VICKI

VICTOR 9000. The true original 16-Bit desktop business micro computer. As powerful today as it ever was, 28 thousand Victor 9000 users in the UK alone have made it the industry benchmark others had to match up to . . . now more competitively priced than ever.

VICTOR VICKI. The 9000 you can take with you anywhere – the most powerful portable business machine on the market, with access to the full range of Victor software (over 2000 programmes!) – the Vicki keeps you close to your business . . . keeps you in touch with profits.

VICTOR VPC. So we made it! Fully

Please ask my Victor dealer to make an appointment with me.

Name _____

Address _____

compatible with the 'Industry Standard' . . . more power, more user options, offering access to the mighty IBM* software library . . . here's the versatile business tool with the more realistic price tag.

VICTOR VI. A true champion. We took the speed and power of the Victor 9000, the versatility of the VPC, and we made them one. The new dual-standard 'Vee Aye' – setting new standards for others to follow.

VICTOR  **R**®

WE NEVER FORGET YOU'RE HUMAN

Area of operation _____

Company _____

VICTOR TECHNOLOGIES (UK) LIMITED, DEPT. A.U.1, UNIT 1,
THE VALLEY CENTRE, HIGH WYCOMBE, BUCKS. HP13 6EQ. ACTIONLINE (0494) 450661.

*IBM is a registered trade mark of International Business Machines.

Victor 9000, Vicki, VPC & VI are all registered trade marks of Victor Technologies Inc.

MAKE YOUR PC MULTI-USER FOR ONLY £595

IT SOUNDS UNBELIEVABLE BUT ITS TRUE

With FORMULA IV, the Applicator Creator, your computer system can become multi-user without the need for hardware modifications. Formula IV is the ONLY software that will convert IBM PC, XT, AT, and compatibles into multi-user application systems.

Merely connect two inexpensive terminals to your PC and PRESTO® — you have just created a true multi-user system that triples the power of your computer.

FORMULA IV contains a wealth of features, including a relational database system, a powerful query language, an on-line help facility, a free format report generator, plus menu generation capabilities. FORMULA IV combines the power of a computer language with the simplicity of a word processor for only £595.

MONDIAL ACCOUNTS — a multi-user integrated accounting suite which transforms your single-user PC into a multi-user accounting system. Why should your system be tied down to only one application when it could be doing stock control, sales invoicing, and payroll all at once?

PHONE TODAY FOR DETAILS OF THESE AMAZING PROGRAMS.

Check our prices on these IBM compatibles

Ferranti PC860
Canon A200
Commodore PC10

Ring for software special offers

CARRERA COMPUTING
12, Lyons Avenue
Hetton-Le-Hole
Tyne & Wear
DH5 0HS

Tel: SUNDERLAND (0783) 267816

Open 7 days 9.00am — 9.00pm

Word-Bird

is not “user friendly” it is *easy* and *natural* to use.

No commands, no keying-in sequences, no “easy” reference cards.

Can be used immediately, mastered in days.

Labels, letters and fully-formatted books are typed direct to the screen, as they will look on paper, with all the emphasis and special characters your printer is capable of.

Easy, natural multi-lingual use.

Full wordprocessing power at your fingertips.

Phone for your **FREE** copy of the Word-Bird Book of Wordprocessing *now!*

**SPECIALISED MULTILINGUAL WORD
PROCESSING SYSTEMS**

LEABUS

114 Brandon Street
London SE17 1AL
Telephone: 01-708 2756

*Legal & Business
Software*

I.S.C.

Offer the UK's lowest prices on computer systems

APRICOT TWIN 315K and monitor	£1,350
APRICOT TWIN 720K and monitor	£1,500
APRICOT XI 5MB and monitor	£2,000
APRICOT XI 10MB and monitor	£2,150
APRICOT F1 720K Excl monitor	£850
APRICOT XI IOS (+ monitor)	£2,775
APRICOT XI 20S (+ monitor)	£3,455
APRICOT XI 20 (+ monitor)	£3,115
APRICOT point 32 10MB (+ monitor)	£2,395
APRICOT point 32 20MB (+ monitor)	£3,395
COMPAQ PORTABLE	£1,870
EPSONRX80F/T	£210
EPSONFX80	£310
EPSONRX100	£330
EPSONFX100	£400
EPSONDX100	£340
WORDSTAR	£190
LOTUS 1-2-3	£310
D-BASE II	£225
PEGASUS	£175
CANON PW1156A	£399

All products carry 12 months full guarantee, with **HOTLINE** phone support.

Prices exclude only VAT and delivery.

We **GUARANTEE*** the lowest prices!

I.S.C. LIMITED

COMPANY SERVICES INCLUDE:

CUSTOMISED DATABASE SYSTEMS, MAINTENANCE CONTRACTS, INSTALLATION CONTRACTS, NETWORK SYSTEMS, MULTI-USER SYSTEMS.

FINANCING:

CASH, LEASE-RENTAL, LEASE-PURCHASE, SHORT-TERM RENTAL, HIRE-PURCHASE, PERSONAL LOANS, INSTANT CREDIT (subject to status).

* Provide a currently advertised lower price within 7 days of purchase and difference will be refunded.

Call for IBM prices.

TRADE AND EXPORT
ENQUIRIES WELCOME

**GRAPHIC HOUSE, 88 WAVENEY ROAD
ST IVES, CAMBS PE17 4FW**

TEL: 0480 300533

Expand Your PC To A Multi-User System With Advanced Digital's PC-Slave

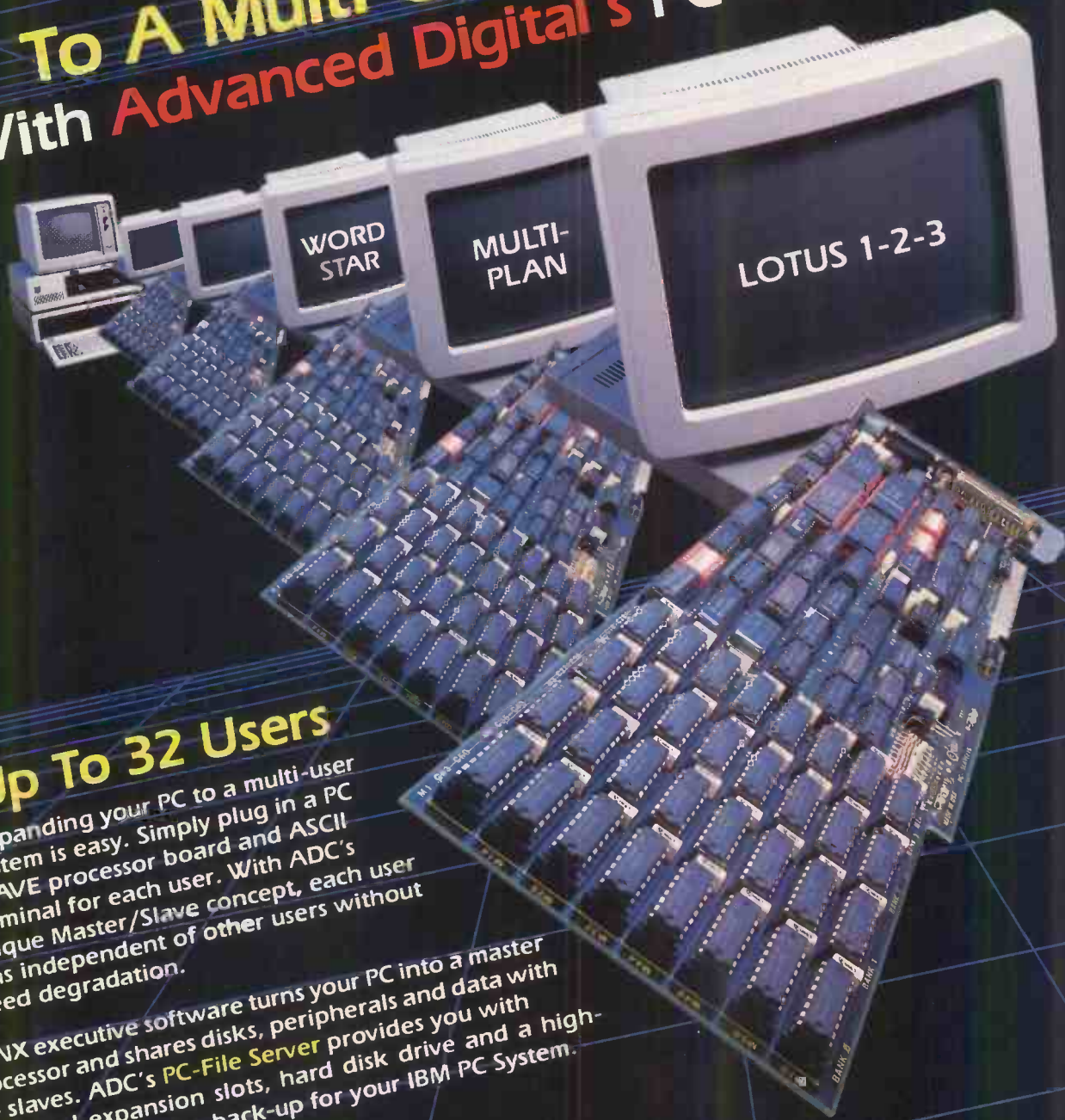

Up To 32 Users

Expanding your PC to a multi-user system is easy. Simply plug in a PC SLAVE processor board and ASCII terminal for each user. With ADC's unique Master/Slave concept, each user runs independent of other users without speed degradation.

RTNX executive software turns your PC into a master processor and shares disks, peripherals and data with the slaves. ADC's PC-File Server provides you with additional expansion slots, hard disk drive and a high-speed streaming tape back-up for your IBM PC System.

PC SLAVE FEATURES:

- 8 MHz, 8088 CPU
- 256 kB of RAM, expandable to 768 kB
- Two Serial I/O Ports

**ADVANCED
DIGITAL
CORPORATION**

Advanced Digital Corporation, USA
5432 Production Drive, Huntington Beach, CA 92649
Tel. (714) 891-4004 • Telex 183210 ADVANCED HTBH

Advanced Digital U.K. Limited
27 Princes St., Hanover Square
London W1R8NO • United Kingdom
(01) 409-0077 • (01) 409-3351 • Telex 265840 FINEST

*RTNX is a trademark of LOGICRAFT
*PC-DOS is a trademark of International Business Machines
*MS-DOS is a trademark of Microsoft Corporation
*LOTUS 1-2-3 is a trademark of Lotus Development Corporation
*Multi-Plan is a trademark of Micro Soft Corporation
*WordStar is a trademark of MicroPro Corporation

Computer Enterprises International Ltd.

INFOSCRIBE

HEAVY DUTY MATRIX PRINTERS



- 100% DUTY CYCLE
- 200 CPS DRAFT, 100 CPS CORRESPONDENCE
- 40 CPS NEAR LETTER QUALITY
- EXTENSIVE SERIAL & PARALLEL INTERFACES
- OPTIONAL 8 COLOUR PRINTING
- WILL PRINT UP TO 7 PART DOCUMENTS
- VERY QUIET 54dB
- MULTIPLE & DOWNLOAD CHARACTER SETS
- FREE PENMAN PLOTTER

FREE

with INFOSCRIBE 1100

Suddenly, quality plotting is within reach of every computer user...

Penman Plotter
 Penman Products Limited
 11 Highbury Grove, Goswell Road, London EC1M 6TA
 Tel: 0753 7077

£1365

OLIVETTI	
OLIVETTI M21 portable, 128K	£1399
OLIVETTI M24, 128K, DD, Mono Colour	£1399/£1799
OLIVETTI M24 640K, SD, 10MB HD, Mono Colour	£2595/£2995
OLIVETTI M10, 8K RAM, 24K RAM	£350/£359

IBM	
IBM PC, 256K, Double Drives, Mono Colour	£1900/£2150
IBM PC, 256K, SD, 10MB HD, Mono Colour	£2990/£3300

APRICOT	
APRICOT PC, 256K, 2X720, 9" Mono/12" Mono	£1499/£1550
APRICOT XI, 10MB, 1X720, 9" Mono/12" Mono	£2170/£2220
APRICOT XI 10S, 512K, 10MB HD	£2590/£2630
APRICOT XI 20S, 1MB RAM, 20MB, HD	£3395/£4430
APRICOT F1/F1E	£750/£525
APRICOT FP1/2 Portable 256/512K, 720K drive	£995/£1395

KAYPRO	
KAYPRO 2, 2x single sided & free WordStar	£795
KAYPRO 2X, 2x DS Drives & dBASE II, WordStar, etc	£395
KAYPRO 10, 10MB, HD & dBASE II, WordStar, etc	£1695
KAYPRO 286 IBM, AT compat, 2x1.2mb drives	£3995
KAYPRO 16, PC compat, 256K, 2x360K d & dBASE, WordStar, etc	£1695
KAYPRO 16H, PC compat, 256K, 10mb, HD & dBASE, WordStar, etc	£2395

SIRIUS VICTOR	
VICTOR 1, 2MB + 256K/2, 4MB + 256K	£1695/2050
VICTOR V1, (Sinus/IBM compatible)	£390
VICTOR VPC, 15MB, HD, SD, Mono	£2550
PC CARD, (Makes Sinus IBM compatible)	£950

DOT MATRIX PRINTERS	
Smith Corona D200/D300 (wide) 160cps, (40 NLD), Parallel & Serial Interface, Epson & IBM Compatible	£275/£399
Canon PW1080A/1156A (NLD)	£285/£375
Canon P1108A (Colour)	£389
MP165 NLD/165cps	£279
Brother 2024NLD	£899
Epson LX-80 NLD	£229
Epson P401/80	£355
Epson RX801/F	£219
Epson LQ1300	£895
Nanawa CP380/CP880	£179/£199
Wannemann Talley M85/86	£299/£399
Texas Instruments 810-855	£1995/£695
Canon Laser Printer	£2900

D'SYM WHEEL PRINTERS	
Brother HR15/25/35	£315/£650/£795
Julia 6100/6300	£299/£350
Julia 2200	£229
Quen-Data	£219
QUME Letter-Pro20	£446
Olived D250/450	£395/£765
QUME T1/40-55	£1195/£1379
Dabbio 630 API	£1299
Ricoh 1200/1300/1600	£495/£795/£1375
TEC F10-40-50	£995/£1250

MONITORS	
MONOCHROME	
Roland MB121, Green	£120
Philips 7502/7522	£79/£85
Kaga Takan P31/35 Ph/10/15	£99/£119
Yanjen, (Green/Amber/Tilt/Sw)	£99
Swivel & Tilt Monitor Stand	£28

COLOUR	
Roland CC141, 14" (640x200)	£395
Kaga IBM Hi/Ultra 800	£350/£550

SANYO 775, Colour, with free software (*NEW*)	£1795
MACINTOSH, Macwrite + Macpaint/Apple IIe/IIIc...	£1450/£495/799
NEC 8201A Lap Micro, £200 free software	£1299
COMMODORE PC10, 256K RAM, 12" Mono, Double Drives	£299

EPSON	
EPSON QX16 Taxi, Free Software	£199
EPSON PX-8, 64K, CPM, Basic, WordStar/120K RAM pack	£750/£925

MULTI-USER COMPUTERS	
NORTHSTAR DIMENSION, 15MB, HD, 2 User/each user	£4995/£1295
AL TOS XENIX, MPM86, 1 to 8 Users, Ethernet	£900
OLIVETTI 382 Unix V for UNIX Software	£199

LOOK!
 This Month's Amazing Specials!

SANYO 550, 128K, 1x160K drive & WordStar, Calstar	£595
SANYO 555, 128K, 2x160 K & £1000 Micropro Software	£795
SANYO 555-2, 128K, 2x360K & £1000 Micropro Software	£1295
TELEVIDEO PC1605, IBM Compat, 256K	£1299
HYPERION PORTABLE, IBM Compat, 256K & Free Software	£1099
NEC APC II, 2x1mb Disk Drives, 128K Ram	£999
SINCLAIR QL Spectrum+	£299/£399
COMMODORE 64/Plus 4	£150/£175
ADORN Electron Starter Pack/BBC with DFS	£125/£350
APRICOT 10" Hi-Res Colour Monitors	£315
RG AND 12" MB121A, Medium-Res Amber Monitors	£36
FIDELITY CM14 RGB/Composite Col Monitor with Speaker	£149
SMITH CORDINA FASTEXT 80/D100 (120cps) Printers	£115/£165
SEIKOSHA GP500A/GP700A, Four Colour Printer	£39/£250
RITEMAN Informer II, NLD Printer	£275

Kaga K12R1X, RGB/PAL	£239
Sinclair Vision QL	£235
Microvite Monitors	£70A
Princeton MX-12/SR12	£490/£545

TERMINALS	
Qume 101/102/103	£455/£515/£695
Qume QVT 108/211	£501/£799
Hazeltine Esprit III (TV1950)	£655
Wyse WY50/WY75	£595/£699

PLOTTERS & DIGITISERS	
Roland DXY800 (8Pen/A3)	£495
Roland DXY880 (HP Compatible)	£795
Roland DXY980	£1150
HP 7470/7475	£995/£1450
Epson H130/Expansion RAM	£395/£69
Houston DM742 (A2)	£295
Summagraphics Bitpad 2	£595
Houston Hi-Pad	£899

SOFTWARE	
(Phone for any Product at Best Prices)	
GEM Desktop v1.0	£49
WordStar 2000 (IBM/Amproc)	£295
Datafile (Single-Board User)	£595/£990
Lotus 123/Symphony	£299/£425
Open Access-2 (IBM/Amproc)	£350
Framework/Friday	£350/£175
Dbase III/III	£250/£350
Sensible Solution	£95
PC-Paint With Mouse	£180
Pison Xchange (4 Int. Package)	£395
Card-Box/Plus	£195/£290
File Transfer, IBM/Amproc/Sinus	£95
Autocad with ADE 1 & 2	£195
Doodle (CAD Package for IBM/Amproc)	£895
Network (Circuit-Board-Design)	£895
OED+Main Street Filer	£290/£150

COMMUNICATION	
Buzzbox Modem/V21 Auto Answer/£90	£139
Minor Miracles V21/V22	£129
Steebec SB1212/V22AD	£450/£550
Communicate (Sinus/Amproc)	£350
Telecom Grid/Easylink/One to One	£90A
Sage Communication Pack	£295

ADD-ONS AND ACCESSORIES	
All Hard Disks & Tape Streamers	£199
AST/Quad-Tecmar Cards for IBM PC/XT	£199
BBC 100K Drives/DFS Kit	£89/£75
Apple II Drives/Controller Card	£95/£40
Apple II+ EIC Cards	£199
Hercules Graphics/Col Card	£599/£199

MICRO COMPUTER CONSULTANTS LTD

OUR PRICES ARE VERY
COMPETITIVE

A Challenge to
 Every businessman

MACINTOSH

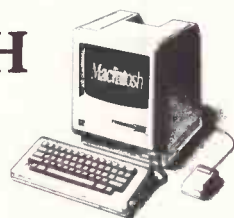

**ALL the APPLE range
 at BARGAIN PRICES!**

PORTABLE Luxury with the

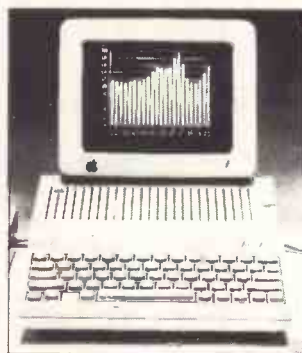

APPLE IIC

- ★ Built-in disc drive
- ★ 128K RAM
- ★ 40/80 column display
- ★ TV Modulator
- ★ 6 interactive demo discs
- ★ Ultra Hi-Res
- ★ Built-in serial ports for printers and modem
- ★ Weight only 7.5lbs
- ★ External power supply



**Authorised Apple Dealer
 Level One Service Centre**

Call TODAY for further details



**Ascott House, 227 Elliott St
 Tyldesley, Manchester
 M29 8DG**

Tel: 0942-892818

☆☆☆OVERSEAS ORDERS A SPECIALITY☆☆☆

COMPUTER ENTERPRISES INTERNATIONAL LTD

Tel: 01-543 6866 542 4850. Telex: 946240 CWEASY G (Quote: 19005565).

EASYLINK MAILBOX: 19005565 TELECOM GOLD MAILBOX:

SHOWROOMS (OPEN Mon-Sat 9.30 to 6)

85-85A QUICKS ROAD, WIMBLEDON, LONDON SW19 7EX UK. LESSINGSTRASSE 60, 5300 BONN 1

GERMANY. Tel: 0228 220297

Export, Educational, Dealer, Governmental, Lease, Rent, Consultant ENQUIRIES WELCOME. All items new and carry manufacturers guarantee. Prices are exclusive of VAT. Installation, Training, Delivery and subject to change without notice. Delivery £10 for each item in UK. £75 for Europe. Payment by Eurocheques, Credit Cards, LC, IMO, Direct Transfer.

ALTOS 486 Series

from £7695.00

- Entry level XENIX System
- up to 4 terminals
- 0.5 Mbyte RAM memory
- 20 Mbyte Hard Disc
- one networking port
- 80168 8 Mhz processor
- includes one ALTOS terminal
- 1 floppy drive
- 5 serial ports
- XENIX 3.0 runtime included

The ALTOS 486 is a cost effective XENIX system with a wide range of database, communications and applications software available. ALTOS Teamnet is supported via the networking port for expansion. Ask about PC PATH for adding your IBM PC to the ALTOS network.

ALTOS 586 and 986 series

from £9235.00

- 10 Mhz 8086 based systems with XENIX 3.0 operating system
- up to 1 Mbyte RAM memory
- up to 80 Mbyte Winchester
- Low cost ALTOS Teamnet
- One Altos terminal included
- up to 9 users
- cartridge tape backup
- Ethernet
- 1 floppy drive

The ALTOS 586 and 986 series offers high performance, and a wide range of applications, database and communications software. ALTOS Teamnet supports transparent networking for distributed databases, Telex and 3270 and 3280 communications. Enquire about PC PATH to integrate ALTOS and IBM PCs.

ALTOS 68000 Series

from £12,450.00

- Motorola 68000 processor
- up to 16 users
- -1 floppy drive
- Multibus expansion
- ALTOS-NET or Ethernet
- UNIX III
- up to 160 Mbyte Winchester
- cartridge tape backup
- Large memory space

The ALTOS 68000 is an excellent UNIX workhorse for software development work, and scientific and technical processing.

WYSEpc

from £1925.00

- MS-DOS 2.11
- 256 Kbyte RAM
- Parallel printer interface
- 2 360 Kbyte floppy
- runs Lotus 1-2-3 etc
- GW Basic
- 2 RS232 serial ports
- 14" colour or mono screen
- or 1 floppy & 10 Mbyte HD
- IBM expansion slots

The WYSE pc is an elegant and powerful, but economical microcomputer with IBM compatibility and improved ergonomics.

Systematika Ltd. offers a full installation service with a wide range of terminals, printers and applications software.

Systematika Ltd.

6-7 West Smithfield, London EC1A 9JX. Tel: 01-248 0962

LUTTERWORTH SOFTWARE

THE NUTCRACKER SUITE

Why use a sledgehammer to crack a nut? Most word-processors are too powerful, too complex and too expensive. The Nutcracker Suite's three programs are really easy to use. You can even print text as you enter it. Has word-wrap and paragraph reforming, plus line and page editing functions using every key in the most natural way. Reads and unscrambles Wordstar files. Saves and prints in 100% ASCII format. Special printer control program also included.

Winner C.T.A. Award Best Business Program 1984

THE ULTIMATE DIARY

Event based diary for every professional. Events can be entered with a frequency tag (e.g. every two weeks, every three months, annually, even every second Tuesday!), and will re-appear in all future reports. Reports for today's events, this week's events, this month's events. Calendar for any month up to 2083. Simple search routine (any field) with wild cards. Up to 5000 separate entries, which can easily be amended or deleted.

MICROFILE

Powerful flat form database. User can set field lengths and labels for any number of separate databases. Up to 16 fields and 32,767 records. Search or sort on any field. Print format options, allowing mail-merge, on both automatic and inspection basis. Superbly easy to use with all prompts on screen.

EACH PROGRAM IS ONLY £43 + VAT (£49.45)

FORMATS: IBM PC DOS/APRICOT MS DOS

Ask your dealer for a demo, or send cheque to:



LUTTERWORTH SOFTWARE,



126 NEW WALK, LEICESTER LE1 7JA (Tel. 0533 550822)

SOFTSEL®

It's available from your local Softsel dealer.

ADVANCED MICRO PRODUCTS
200 COURT ROAD
ELTHAM, LONDON SE9 4EW.
TEL: (01) 851 3311

CALLHAVEN LTD
43 FIFE ROAD,
KINGSTON-UPON-THAMES
SURREY KT1 1SF.
TEL: (01) 549 5612

CLM MATMOS PLUS
14-16 CHILDS PLACE, EARLS CT.
LONDON SW5 9RX.
TEL: (01) 373 6607

COMPUTERLAND
38 EDGWARE ROAD,
LONDON W2 2EH.
TEL: (01) 723 3071

INFORMETRICS
THE FARMHOUSE, LOW ROAD,
KESWICK, NORWICH NR4 6TX.
TEL: (0603) 54805

PERSONAL COMPUTERS LTD.
220/226 BISHOPSGATE,
LONDON EC2M 4JS.
TEL (01) 377 1200

PILOT SOFTWARE
32 RATHBONE PLACE,
LONDON W1P 1AD.
TEL: (01) 636 2666

PEAR COMPUTING SYSTEMS LTD
129 QUEENS CRESCENT,
LONDON NW5 4HE.
TEL: (01) 267 0940

SOUTH WALES COMPUTERS
131 B & C ALBANY ROAD,
CARDIFF,
S. GLAMORGAN CF2 3NS.
TEL: (0222) 490572

TASHA BUSINESS SYSTEMS
191 KENSINGTON HIGH ST.
LONDON W8.
TEL: (01) 937 7896

THAMES VALLEY SYSTEMS
GREYS HOUSE,
7 GREYFRIARS ROAD,
READING, BERKS RG1 1NU
TEL: (0734) 581829

THE CITY COMPUTER CENTRE,
105 WHITECROSS ST.
LONDON EC1Y 8JD.
TEL: (01) 588 5537/8

VEGA COMPUTERS LTD
6 SUFFOLK HOUSE,
GEORGE ST.
CROYDON, SURREY CK0 1PH.
TEL: (01) 680 4484

Typing Tutor III™

Simon & Schuster, Inc.



Miss Carruthers beats the clock, thanks to Typing Tutor III™

Deer... Der..... Dear Sur..... Dear Surr.....

Miss Carruthers fumbled for her correction fluid once again. So much of the stuff was brushed on her letters, they had to be sent by parcel post.

It was costing Harry Armitage, her boss, a fortune.

So he decided to invest in Typing Tutor III™. The revolutionary typing instruction program from Simon and Schuster™.

After all with a recently acquired computer in the office, she'd have to sharpen up her skills pretty quickly.

Typing Tutor III – THE KEY TO BETTER COMPUTING

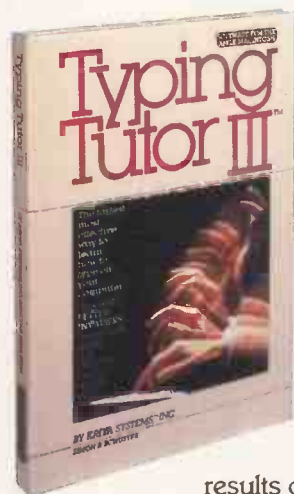

Available for the Apple II™, Apple Macintosh™, Atari™, Commodore 64™ and IBM PC™. Typing Tutor III allows professionals, students, writers and secretaries to utilize the power of a personal computer to the full.

It's composed of a series of self-paced custom designed typing lessons and tests. All of which are automatically adjusted to match your ability and progress levels.

Typing Tutor III contains a feature called Time Response Monitoring™. TRM™ analyzes the results of each test and clearly shows your

speed, accuracy, strengths and weaknesses. And to help you see the error of your ways your progress is reproduced in graph form.

EXTRA TERRESTRIAL TYPING

Typing Tutor III also comes complete with Letter Invaders™. An exciting arcade-style game in which you have to defend earth from invading fleets from outer-space. As each letter or symbol comes into view, blast it by typing it on the keyboard. As your typing gets faster the game gets faster.

Typing Tutor III is simplicity itself to use and comes complete with reference manual.

It's available from your local Softsel dealer along with over 2,600 other titles from over 250 publishers.

Miss Carruthers typing improved beyond all recognition. So much so that Harry Armitage entered her for the Typing World Championships.

And although she romped home with a top score of 160 wpm, he knows of one lady who could beat his secretary out of sight in the words-per-minute stakes.

His mother-in-law.

Typing Tutor III – A hands down winner.

SOFTSEL®

**The number one distributor of Software.
In the world.**

Softsel Computer Products Limited, Softsel House, Syon Gate Way, Brentford, Middlesex TW8 9DD.

QUME



gives you so much more –

a wide range of quality peripherals + Qume's superior back-up

- Fully equipped Service Departments.
- Field service from authorized 3rd party maintenance organizations.
- Personnel Training Centre.
- Local support from 1st class Distributor Organization.
- Supplies and spares available from stock.
- ITT world-wide technology.
- Qume (UK) Limited, a solidly established British Company.

● THE QUME PACKAGE



QVT 202
The Digital Emulator



QVT 109
Function keys and non-embedded attributes. So useful for the O.E.M.

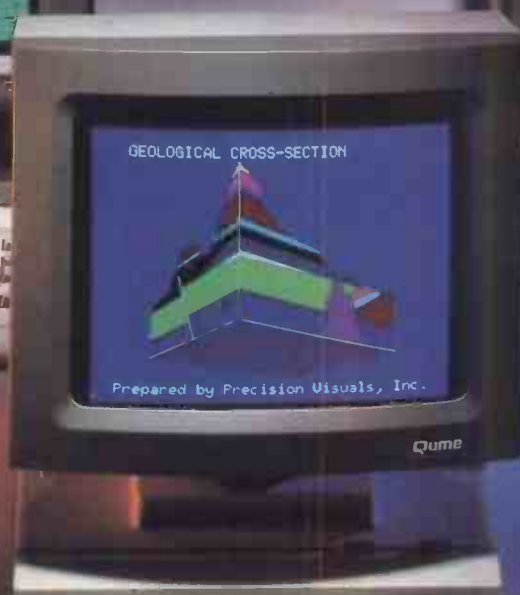

QVT 511
the Tektronix Emulator at a realistic price.



Phone or write to Qume at Newbury for full details of the New Advanced Range of Video Terminals.

The Qume range of video terminals – so superior they are 1st choice with professionals everywhere.

Qume (UK) Limited

Marketing and Sales
Park Way, Newbury, Berkshire RG13 1EE
Telephone: (0635) 31 400 Telex: 846321

Service and Training Centre
Bridgewater Close, Reading, Berkshire RG3 1JT
Telephone: (0734) 584646 Telex: 849706

Qume
The Quality Peripherals People

A British Company of ITT

Qume is a registered trademark of Digital Equipment Corp.
QVT is a registered trademark of Tektronix Equipment Corp.

VicOdden's

London's Computer Specialist

of London Bridge

MEGADEALS

Trade-in your weeny 1/2K Hoity-Toity 3000 for the latest 30 Mega Thingy Quality Leap. We also buy Computers & Peripherals for CASH (If you can't put up with its superior comments having spent 24 hours playing 'The Hobbit' and getting .002%) We'll even take your sooper-doooper computer gear in part exchange for weird but wonderful Hi-Fi rigs, Walkpersons etc from our Lo/Mid/Hi-Fi store or against Niknok, Conan, Printax, Oilmouse cameras and 30,000mm lenses from our two photographic emporiums.

HOW TO FIND US



6, London Bridge Walk, London SE1
 Tel: 01 403 1988
 Open 8.30-6pm
 Mon-Frid
 9am-1pm Sat

ChipChat

Modem

ChipChat modems are the most versatile and up to date available at the price. With autoanswer as standard and intelligent autodial with speed conversion as an option, ChipChats may be used to access computers and databases such as Prestel, Micronet, Homelink and BT Gold.

ChipChats support the CCITT V21 protocol: 300/300 baud and the V23 protocol: 1200/75, 75/1200 and 1200/1200 (half duplex). Where local regulations permit, Bell standard operation may be used for dialling US databases.

ChipChats use the latest technology and provide valuable extra features such as auto-disconnect to save your telephone bills, and speed conversion for operation with IBM PCs. A full complement of LEDs monitor data flow and the status of handshake lines on the Cannon D-type connector.

ChipChat modems have been designed with our experience of manufacturing BT approved intelligent terminals, they provide the facilities and data rates you need at the touch of a button or they can be left unattended under computer control.

ChipChats are supported by a large range of communications software packages and terminal emulations for the IBM, Sirius, Apricot, Apple and BBC micros.

Ring for details and special package deal prices.

ChipChat	CC2123A	Autoanswer	£130.35
			£149.90 inc VAT
ChipChat	CC2123AD	Autodial	£165.13
			£189.90 inc VAT
			P & P £2.70 + VAT

BABT Approval
 Applied For



Digisolve
 Micro electronic design consultancy

Digisolve Limited
 Aire and Calder Works
 Cinder Lane, Castleford, West Yorks WF10 1LU
 Tel: 0977 513141 Telex: 557661 AGRAM G

Get ready for t



The 1985
**Personal
Computer
World
Show**

he main event!

The main event in personal computing has got to be the Personal Computer World Show at Olympia.

It's where the big names and the up-and-coming stars will be put through their paces this September. You'll see a massive line-up of contenders with hardware, software and peripherals from the whole world of the micro. Which means there's something for everybody.

So, whether you're a cold blooded professional or simply an enthusiast, you'll profit from the experience.

Over 45,000 micro users did last year. And this September's PCW Show will be even bigger. With new special features like the Applications Advisory Service, Business Advice Centre and workshop sessions through the National Computing Centre, the Micro Home of the Future, Top Twenty Games, Micros in Education and a separate hall exclusively for business computer buyers.

If your interest in personal computers is business or professional, or if you simply want a family outing that's informative and fun, you must get to the Main Event.

The arena is Olympia, London. The dates are 4-8 September.

For advance tickets at £2.00 each, ring PCW ticket office on 01-486 1951 with your Barclaycard or Access number or write with your cheque to PCW Show, 11 Manchester Square, London W1M 5AB.

Box clever. Don't miss it.



4-8 SEPTEMBER 1985
OLYMPIA, LONDON

Sponsored by Personal Computer World

The main event!

Business, professional and trade only
days 4-5 September 1985.

Get Flexible Get Forth



FORTH programs are instantly portable across the most popular microprocessors.

FORTH is interactive and very fast.

FORTH programs are structured, modular, and easy to maintain.

FORTH gives control of all interrupts, memory locations, and i/o ports.

FORTH gives full access to DOS files and functions.

FORTH application programs can be converted to turnkey programs.

FORTH Cross Compilers can generate ROMmable code for: 6502, 6809, 68000, 0808, Z80, 8086, 6800, 6801/3, 1802, Z8, 8070, Z8000, 99xxx, LSI-11

Application Development Systems include **FORTH** with virtual memory, multi-tasking, assembler, full-screen editor, decompiler, utilities, and full documentation.

MPE 6809 FORTH - Flex OS9	£175
MPE PDF 11 FORTH - RSX 11	£1500
VAX by FORTH-SYSTEME - VMS	£1500
MPE/NAUTILUS CROSS COMPILEH - CPM MSDOS	From £225
LMI PC/FORTH	£110
LMI 8086 FORTH	£110
LMI Z80 FORTH	£95
MM APPLE FORTH	£145

Extension Packages include floating point, cross compilers, 8087 support, colour graphics, interactive debuggers.

We are the **Forth** specialists, we also stock a large range of books, listings, and implementations for machines ranging from Spectrums to Macintosh to VAX.

Microprocessor Engineering Ltd

21 Hanley Road, Shirley
Southampton SO1 5AP
Tel: 0703 780084



Ask the right people first.

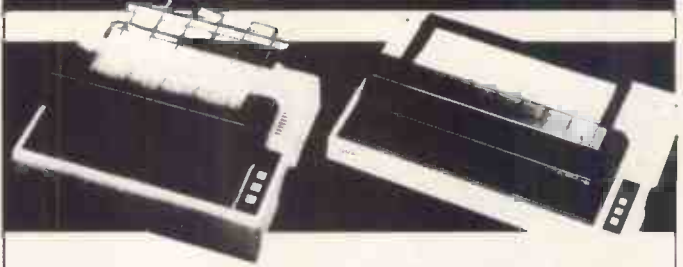

- * Fast 24 hour delivery
- * Full range of Epson Printers and Interfaces
- * Ask for our Price Lists, Brochures and Print Samples
- * Trade enquiries welcome (ask to be added to our Mailing List)
- * Full Technical Support and Service Contracts available.

EPSON

Versatile and Reliable. The Fastest Movers around

Westwood Distribution

Distributors to the Computer Trade

DIAL 100 AND ASK FOR FREEFONE WESTWOOD TO GET FULL DETAILS

Westwood Distribution Ltd., 116/118 Tennant Street,
Five Ways, Birmingham B15 1EY. Tel: 021-643 8680.



DEALERS AND CONSULTANTS

If you have a used computer system to buy or sell then make sure you talk to the right people.

COMPUTERLINES

A Market-Place for Used Computers

Computerlines used computers is a market-place for used computer systems and peripherals like printers and hard disk units etc. It is boxed on Prestel - page 36019 - the most interactive public viewdata system in the world.

Some used systems currently on offer are:

APRICOT XI	SUPERBRAIN 1
SIRIUS	TELEVIDEO
ALPHA MICRO	SAGE IV
DIABLO	DIGICO PRINCE
OSBOURNE I	RICOH
COMMODORE 8050	QUME 5/45

For non Prestel users, lists of systems on offer are mailed on request.

INTERLEX LTD

Microcomputer Systems and Services
Imperial House, Lower Teddington Road
Kingston upon Thames, Surrey KT1 4EP
Tel: 01-943 4366. Telex: 928017 Scott G

TG Mailbox: MMU429. Prestel Mailbox: 019434366

SECURE MEDIA AGAINST MAGNETIC FIELDS

For just £30 (+ VAT) the GAUSSBUSTER will enable you to *positively* and permanently identify all those potential danger areas in your office, laboratory or factory, etc.

The GAUSSBUSTER is a pocket instrument for tracking down those corrupting magnetic fields. Supplied complete with battery, full instructions and a supply of stickers, at the push of a button permanently identify all that dangerously radiating equipment.



Please rush me..... (Qty) GAUSSBUSTERS
@ £34.99 each inc p&p and VAT/Enc £

Name

Address

DOWNING ELECTRONICS LTD
24 DOWNING ROAD, TILEHURST,
READING, BERKS RG3 5BB

Please allow 28 days for delivery

Yet another unbeatable deal from Datastar Systems!

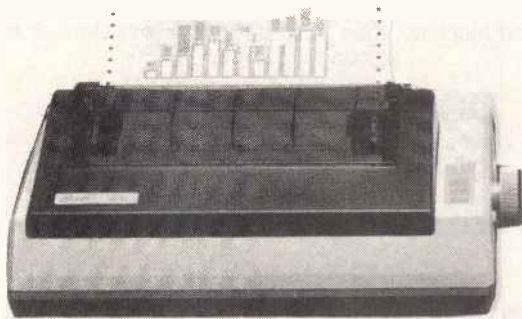

STAR SG10

Character Sets

96 Standard ASCII Characters
 88 Standard International Characters
 96 Italic Characters
 88 Italic International Characters
 96 NLQ Characters
 88 NLQ International Characters

Character Matrix

Standard Characters: 9 dot x 11 dot
 STAR Block Graphics: 6 dot x 6 dot
 IBM Block Graphics: 12 dot x 11 dot
 User Defined: 8 dot x 4 to 11 dot
 Near Letter Quality: 17 dot x 11 dot

Character Fonts

Normal (10 CPI)
 Elite (12 CPI)
 Condensed (17 CPI)
 NLQ (10 CPI)

Line Spacing 1/6, 1/8 in. or 7/32 in. Standard
Dimensions (W x D x H)
 392 x 315 x 145mm (15.4 x 12.4 x 5.7 in.)
Number of Columns
 80, 96, 136, (40, 48, 68 Double Width)
Print Head 9 Wires (User Replaceable)

THE INCREDIBLE NEW STAR SG-10 NEAR LETTER QUALITY PRINTER.

features:—

- ✧ Epson and IBM compatible print codes
- ✧ Friction and tractor feeds.
- ✧ Externally Accessible DIP-Switches
- ✧ High-resolution bit-image graphics
- ✧ Downloadable character sets
- ✧ NLQ, italics, condensed, enlarged, super & subscript styles.
- ✧ High 120 CPS print speed, logic seeking.
- ✧ Hex dump facility.
- ✧ Macro-instructions.
- ✧ Touch-sensitive control panel.
- ✧ Standard parallel Centronics interface.
- ✧ 2K print buffer — expandable to 10K
- ✧ Commodore 64 version available shortly

Star SG-10 £259 + VAT	£297.85
Parallel cable for any Micro (max. price)	£20
2 Spare ink ribbons	£5
2000 sheets of continuous listing paper	£15
Next day doorstep delivery service	£10
	<hr/>
	£347.85

Datastar's all in price £297.85!!!

Post your cheques to

Datastar Systems UK

Unicom House, 182 Royal College Street, London NW1 9NN. Telex 295931 UNICOM G

PERSONAL CALLERS WELCOME — We are situated by the junction of Camden Road, near the railway bridge
 MONDAY-FRIDAY 9-6 SUNDAY 10-1 EXPORT ENQUIRIES WELCOME

Credit Card Hot Line 01-482 1711

AS MAIN DISTRIBUTORS FOR THE STAR RANGE, WE ARE ABLE TO OFFER EXCELLENT DEALER MARGINS

MICRO TIME

INTERNATIONAL LIMITED

106A Bedford Road, Wootton, Beds. MK43 9JB
Telephone: Bedford (0234) 767758/766351

SOFTWARE

Databases
Spreadsheets
Text Formatters

Business Packages, incl:

Quotation/Estimating for Contractors
Lighting/Heating/Electrical Design

Time Costing for Professionals ★
Project Management ★
Expense Recording ★
Sales Order Recording ★
Appointment Scheduling ★

★ MS-DOS/PC-DOS versions available for most popular desktops and portables.

plus

Games, Assemblers, De-bugging tools, etc.

NEW!! T-View 80 gives your 40-column lapheld a 60/80 column display!
On cassette or ROM!

NEW!! MULTI-FUNCTION ROM SOFTWARE for the NEC PC-8201A and Tandy Model 100!!

T-base relational database, Travelling Writer menu-driven text formatter, and IDEA! – the powerful new outline processor all on one 32K ROM for only £175 (ex VAT).

HARDWARE

PC-8201A portable computers
8K RAM chips for NEC and Tandy
Data recorders
RS-232C and Parallel printer cables
Modems and Acoustic couplers
Desk top and portable printers, both matrix and daisy wheel.

NEW!! FB-100 portable, battery-operated, 3.5" microfloppy disk drive for use with the NEC PC-8201A and Tandy Model 100 lapheld!

NEW!! The MAC-In Measure and Count Input Device a set of two wands including pressure contact pen for "counting" items and wheel pen for measuring distances on plans (with scales of 1:1 to 1:1000).

SEND OR RING FOR DETAILS TODAY FROM MICROTIME

Approved NEC PC-8201A dealers

SYNTAX soft
3 BULCOCK STREET
BURNLEY BB10 1UH

PRESENTS!

Three exciting programmes for the Memotech computer

MEMOSKETCH

The ultimate graphics programme. Draw your own pictures then save them and use them within your own programmes. The demo screens must be seen to be believed, £8.95.

QUANTUM

High speed machine code action. Pit your wits against the power ball, £7.95.

DOCTOR FRANKIE

This gruesome saga is a must for all games players. A very difficult and exciting game, £7.95.

JUST RELEASED FOR THE TATUNG EINSTEIN

AGROVATOR

This mammoth maze game bears no resemblance to any other type of maze game. 30 random screens and a 100% machine code action, £9.95.

Tel: 0282 57427

Connexions

Magic
MOUSE



For the Commodore 64 **£59.95**

INC. VAT

- CREATE HI-RES GRAPHICS
- TRANSFORM YOUR OWN PROGRAMS
- COMES COMPLETE WITH DISC AND TAPE SOFTWARE – NO EXTRAS REQUIRED
- SOFTWARE INCLUDES HI-RES GRAPHICS PACKAGE, MOUSE CONTROLLER, SPRITE DESIGNER, ICON DESIGNER

Phone your nearest stockist

Tel: 01-441 1282

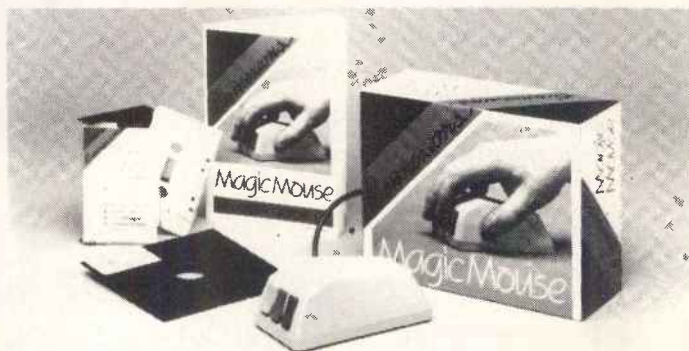

Another Connexions product from:

SMC SUPPLIES

11 Western Parade, Great North Road, Barnet, Herts EN5 1AD
Tel: 441 1282, 441 1698, 441 0535, 441 1225. Telex: 295181 SMC G
TRADE/EXPORT ENQUIRIES WELCOME

ATARI 520ST

POWER WITHOUT THE PRICE

THE NEW ATARI 520ST

Under the new leadership of Jack Tramiel (former boss and founder of Commodore Business Machines), Atari Corporation have marked their entry into the world of business/personal computers with a machine which leaves the competition standing. Tramiel's slogan 'Power Without the Price' has been implemented in the manufacture of the new 512K Atari 520ST colour computer which offers the user amazingly high performance at an incredibly low price. Launched as a work-station, this new system incorporates seven software packages as well as the 520ST computer with 512K RAM, mouse controller, high resolution monochrome monitor (640x400), 95 key keyboard (with 18 key numeric keypad), MIDI interface, GEM and a 500K 3 1/2 inch disk drive, all for the package price of only £651.30 (+VAT = £749). Dubbed the 'Mac beater' and the 'Jackintosh' (after Atari's Chief, Jack Tramiel), Atari's new machine has been directly compared with the Apple Macintosh RRP £2995 (+VAT = £2985) which offers similar features and capabilities but at a much higher price. Favourably reviewed by the UK's highly critical specialist computer press, the 520ST is likely to make a great impact in this country as a sophisticated alternative to an IBM PC, APRICOT or APPLE MACINTOSH. Unlike its overpriced competitors, the Atari 520ST can be linked up to a colour monitor to unleash a choice of up to 512 colours. The addition of colour brings out the full potential of graphics packages such as GEM.

USER FRIENDLY GEM OPERATING SYSTEM

The power of the ST is harnessed and made user friendly by the new operating system 'GEM' from Digital Research. GEM stands for Graphics Environment Manager and allows a user friendly colour or B/W graphics interface which closely resembles that of the Macintosh. This similarity extends to the use of moveable resizable windows, icons to represent objects such as disks and disk drives, and the use of pull down menus and a mouse. The advantage of all this is that the computer becomes extremely easy to use. GEM has now been implemented for the Acorn, ACT, Atari, IBM, iCL, and Olivetti. Software written for GEM on one computer should also run under GEM on another computer. This will enable the market to quickly produce a large library of standard interchangeable software.

FREE SOFTWARE AND FUTURE EXPANSION

The Atari 520ST comes supplied with seven free software packages as listed below: 1) TOS - Tramiel Operating System based on CPM 86K. 2) GEM Graphics Environment Manager by Digital Research (DR) giving a WIMP (Window, Icon, Mouse, Pull down menu) environment. 3) DR GEM Paint for creating graphics masterpieces. 4) DR GEM Write for word processing. 5) Logo learning language to enable you to write your own programs easily using turtle graphics. 6) DR Personal Basic a powerful user friendly version of the basic programming language. 7) BOS operating system giving you access to dozens of business applications packages already available on the market. Designed with future expansion in mind, the ST also features a host of different interfaces to the outside world and an impressive list of accessories is planned. Atari will soon be releasing a 1000K (1MB) 3 1/2 inch disk drive, and a 15MB hard disk storage system as well as a mass storage compact disk (CD) player capable of storing an entire 20 volume encyclopedia on one disk. A full range of inexpensive printers are planned including dot matrix, daisywheel and thermal colour printers. With its unbeatable graphics, speed and software at a price which is far below that of any comparable personal computer currently on the market, the ST is set to do battle with the competition. To receive further details of the ST from Silica Shop, just fill in the coupon below with your name and address details and post it to us.

Silica Shop Price: £651.30 + £97.70 VAT = £749.00. This price includes:
★ 512K RAM ★ B/W MONITOR
★ MOUSE ★ 500K 3.5" DISK DRIVE
★ GEM ★ KEYBOARD (95 KEYS)

ATARI 520ST SPECIFICATION

MEMORY
 512K RAM (524 288 bytes)
 16K ROM expandable to 320K
 Port for addn 128K plug-in ROM cartridges
 200K TOS operating system

GRAPHICS
 Individually addressable 32K bit-mapped screen with 3 screen graphics modes:
 320x200 pixels in 16 colours (low resolution)
 640x200 pixels in 16 colours (med resolution)
 640x400 pixels in monochrome (high res)
 16 shades of grey in low res mode
 512 colours available in low/medium res
 8 levels of each in red, green and blue

ARCHITECTURE
 4 custom designed chips
 GLUE Chip - MMU Memory Mngmt Unit
 DMA Controller - Graphics Processing Unit
 16.02 bit Motorola 68000 processor at 8MHz
 eight 32 bit data registers
 eight 32 bit address registers
 16 bit data bus/24 bit address bus
 7 levels of interlaced/56 instructions
 14 addressing modes/5 data types

DATA STORAGE
 High speed hard disk interface
 Direct memory access 1.33 Mbytes per second
 CD (Compact Disc) interface
 Built in cartridge access
 Dedicated floppy disk controller

DISK DRIVE
 500K (unformatted) 5 1/4" floppy d/drive
 348K (formatted) storage capacity

SOUND AND MUSIC
 Sound Generator
 Frequency control from 30Hz to above audible
 3 voices (channels) in wave shaping mode
 in addition to a noise generator
 Separate frequency and volume controls
 Dynamic envelope controls
 ADSR (Attack, Decay, Sustain, Release)
 Noise generator
 MIDI interface for external music synthesizers

KEYBOARD
 Keyboard/mouse microprocessor
 Standalone QWERTY typewriter styling
 Ergonomic angle and height
 95 keys including 10 function keys
 Numeric keypad - 18 keys including ENTER
 One touch cursor control keypad

MONITOR
 12" screen - high res monochrome monitor
 640x400 monochrome resolution
 Note: Some of the above specifications are pre-release and may therefore be subject to change

VIDEO PORTS

Display - Low Resolution - 40 columns
 Med/High Res - 40/80 plus cols
 Medium res RGB (Red/Green/Blue) output
 High resolution monochrome (Black & White)

COMMUNICATIONS
 Bidirectional centronics parallel interface for printers, or modems capable of input/output
 RS232C serial modem/printer interface
 VT52 Terminal Emulation Software
 Maximum Baud Rate up to 19,200
 High speed hard disk interface
 Floppy disk controller (Western Digital)
 2 joystick ports (one for 2 button mouse)
 MIDI interface for external music synthesizers

GEM WIMP ENVIRONMENT
 WIMP - Window Icon Mouse Pop-down menus
 Two button mouse controller
 Icons/Pull down menus/Windows
 GEM VDI - Virtual Device Interface
 GEM AES - Application Environment Services
 GEM BBT - Bit Block Transfer
 Real time clock & calendar

SOFTWARE
 GEM environment
 with user friendly Macintosh style operation
 TOS - Tramiel Operating System
 Atari's own system based on CP/M 86K with hierarchical directory & file structure plus a host of MS DOS & UNIX command structures
 BOS - Business Operating System
 To run any standard 8085 business programs
 GEM desktop
 with GEM PAINT graphics mgmt system and GEM WRITE word processor
 Personal BASIC and DR Logo originally written by Digital Research (DR)
 Very much like those on other machines except for the extensive use of pull down menus, mouse control and windows

VARIOUS
 Dimensions 470mmx240mmx60mm
 Replaceable external power supplies
 Personal BASIC and DR Logo
 3 1/2" 15MB hard disk
 CD (compact) laser disc
 Dot matrix & d/wheel printers (black)
 Thermal dot matrix (colour)
 RGB & monochrome monitors

LANGUAGES
 BASIC & LOGO supplied
 Many others will soon be available, including: Assembler, BODL, C, Cobol, Compiled Basic, Lisp, Modular-2 and Pascal

MACINTOSH v F16 v 520ST

"Imagine a Fal Mac - the 512K Apple Macintosh - but with a bigger screen, a far bigger keyboard with numeric keypad, cursor and function keys, and colour. That gives you some idea of what the Atari 520ST is like, except for two important things. First the Atari seems faster. Second the Atari system is about one third of the price."
 June 1985 - Jack Scholfield - PRACTICAL COMPUTING

FEATURES OF BASIC SYSTEM	APPLE MACINTOSH	F16	ATARI
Price includes B/W Monitor	YES	NO - extra £200	YES
Keyboard size mm (LxDxH)	330x147x50	450x167x28	470x240x60
Keyboard size mm (LxDxH)	13x5 1/2 x 2	17 1/2 x 6 1/2 x 1	18 1/2 x 9 1/2 x 2 1/2
3 1/2" D/Drive (Unformatted)	500K	500K	500K
3 1/2" D/Drive (Formatted)	399K	315K	348K
WIMP (Window, Icon, Mouse...)	Apple	ACT - Activity	GEM
Real-time Clock	YES	YES	YES
Polyphonic Sound Generator	YES	NO	YES
RS232 Serial Port	YES	YES	YES
Centronics Parallel Printer Port	NO	YES	YES
Dedicated Floppy Disk Controller	NO	YES	YES
Hard Disk DMA Interface	NO	YES	YES
Full stroke keyboard	YES	YES	YES
Number of keys on keyboard	59	92	95
Numeric Keypad	NO	YES (16 Keys)	YES (16 keys)
Cursor Control Keypad	NO	YES	YES
Function keys	NO	10	10
16-bit processor	68000	Intel 8086	68000
Processor running speed	8MHz	4.77MHz	8MHz
RAM size	512K	256K	512K
Number of graphics modes	1	4	512
Max Screen Resolution (pixels)	512 x 342	640 x 256	640 x 400
Mouse included	Single Button	NO - extra £95	Two Button
Replaceable External Power Pack	NO	NO	YES
Cartridge Socket	NO	NO	YES
Joystick Ports	NO	NO	YES (two)
MIDI Synthesiser Interface	NO	NO	YES
Monitor Size	9"	9" - extra £200	12"
RGB Video Output	NO	YES	YES

System Cost with:	Mouse - Monochrome Monitor - 512K RAM - 500K Disk Drive
Price of basic system (exc VAT)	£2995+VAT
★ Mouse	Included
★ Monochrome Monitor	Included
★ Expansion to 512K RAM	Included
Price of complete system (exc VAT)	£2995+VAT

PRICE rounded down including VAT	£2,984	£1,362	£749
----------------------------------	--------	--------	------

PRESS COMMENT

"The electronics in the machine are a work of art... The heart of the 520ST is a Motorola 68000, one of the most powerful 16-bit processors around and in many respects it is close to being a 32-bit chip... when the machine appears in the shops, it'll be at the front of the queue to buy one."
 Peter Bright June 1985 PERSONAL COMPUTER WORLD

"This machine is significantly more powerful than an IBM PC... It's possible to design a sure-fire winning machine, this is it."
 May 11th 1985 PERSONAL COMPUTER NEWS

"... the use of GEM makes the new range of Atari computers so similar to the Macintosh (with the added attraction of colour), that they are already being called 'Jackintoshes'.
 May 2nd 1985 COMPUTING

"The new Atari ST computers truly represent to the consumer what Jack Tramiel is saying - easy-to-use computing power without the price."
 March 1985 ANALOG COMPUTING

"It (the ST) uses the most modern technology that is affordable, in a package that gives a professional impression."
 May 23rd 1985 POPULAR COMPUTING WEEKLY

"The Atari ST is one of the most elegant designs I have seen... Atari has used an original and elegant method of memory management which should make the ST faster than any other PC on the market - in any price bracket... The £4K dollar question is would it go out and spend money for one? To which the only answer is 'Try and stop me!'"
 John Lambert July 1985 ELECTRONICS & COMPUTING

"The 520ST is technically excellent... The 520ST hardware is the new standard by which others will be judged."
 July 1985 YOUR COMPUTER

SILICA SHOP

ATARI WE ARE THE UK'S No1 ATARI SPECIALISTS ATARI

At Silica we have been successfully dedicated to Atari ever since their products first appeared on the UK market. We can attribute our success largely to the Atari specialisation which we practice and to the user back-up we provide. Rest assured that when you buy a piece of Atari hardware at Silica you will be fully supported. Our mailings giving news of software releases and developments will keep you up to date with the Atari market and our technical support team and sales staff are at the end of the telephone line to deal with your problems and supply your every need. With our specialist bias, we aim to keep stocks of all the available Atari hardware, software, peripherals and accessories. We also stock a wide range of Atari dedicated books and through us, the owners on our list can subscribe to several American Atari dedicated magazines. We can provide a full service to all Atari owners and are now firmly established as the UK's NUMBER ONE Atari specialists. Here are just some of the things we can offer to our customers.

- ★ FREE POST & PACKING ON MAIL ORDERS
- ★ FREE NEXT DAY SECURICOR DELIVERY
- ★ INFORMATION MAILING SERVICE
- ★ TECHNICAL SUPPORT TEAM
- ★ HIGHLY COMPETITIVE PRICES
- ★ AFTER SALES SUPPORT SERVICE
- ★ REPAIR SERVICE ON ATARI PRODUCTS

If you would like to be registered on our mailing list as an Atari computer owner, or as a person interested in buying an Atari machine, let us know. We will be pleased to keep you up to date with new Atari developments free of charge. So, return the coupon today and begin experiencing a specialist Atari service that is second to none.

01-309 1111

SILICA HOTLINE

SILICA SHOP LTD, 1-4 The Mews, Hatherley Road, Sidcup, Kent, DA14 4DX SEND FOR FREE ATARI ST LITERATURE

To: Silica Shop Ltd, Dept PCW 0885, 1-4 The Mews, Hatherley Road, Sidcup, Kent, DA14 4DX

PLEASE SEND ME FREE LITERATURE ON THE NEW ATARI 520ST COMPUTER

Mr/Mrs/Ms: _____ Initials: _____ Surname: _____

Address: _____

Postcode: _____

Do you already own a computer
 If so, which one do you own? _____



Are you still waiting a month for your news?

These days, you don't have to be a DP specialist to need news on professional microcomputing. If your work is in financial, sales, production or general management, it's probably equally important.

Whatever your job title you need news and information on professional microcomputing because you're involved with the purchasing and management of micro-systems at work.

Now there is a newspaper written specially for you. Each week from September 4th PC Week will bring you unique news coverage, hardware and software reports and new product reviews from both sides of the Atlantic.

An impressive array of experts and columnists will examine the technical problems associated with everything from choosing software to the latest developments on local area networks.

The distribution of PC Week will be carefully controlled. If you would like to apply for a complimentary subscription please fill in the coupon and return it to us via VNU Business Publications BV, FREEPOST 25, London, W1E 6EZ. PC Week - Britain's first newspaper of professional microcomputing

PC WEEK
BRITAIN'S FIRST NEWSPAPER OF PROFESSIONAL MICROCOMPUTING

Weekly newspaper launch to cover micro growth market

From September of this year professional microcomputer managers and buyers will be served by the first UK microcomputing weekly newspaper written specifically for them.

PC Week, a glossy tabloid newspaper, will appear for the first time on Wednesday 4 September, and from then on will provide a unique news and media for both readers and advertisers - every week.

PC Week caters for a new generation of professional micro users and has been developed by VNU - the UK's biggest computer publisher - in partnership with Ziff-Davis, publisher of the hugely successful PC Week in the USA.

response to a new but increasing demand for information in a market whose development continues to be remarkable.

In 1986 there will be more software, more machines and further technological strides: the applications and implications of micros at work continue to multiply. Business microcomputing needs its own newspaper.

PC Week will cover every aspect of professional microcomputing - from reporting first on all new micro hardware and software launches to analysing the latest marketing and financial trends in the industry. Each week, too, an impressive array of experts and columnists will examine the technical problems associated with everything from choosing software to the latest developments in local area networks.

Above all, PC Week's strength lies in its direct access to that most valuable commodity - news.

Developments of importance to the UK microcomputer profession - from wherever in the world - will be in PC Week first. Micro professionals of all types - whether they be DP managers, financial executives or managing directors - will turn to PC Week for news, for information and for guidance. Advertisers aiming to reach these multiple purchasers of hardware, software and services will find the medium unmatched.

MS-DOS success the brake on

The UK's microcomputer market is growing fast...

Company Memo

Microcomputer Systems Purchase Discussion

Attending:

- Managing Director
- Company Secretary
- Financial Director
- Manufacturing Director
- Manager Technical Services Development
- Computer Operations Manager
- Sales Director
- Marketing Director

Are you involved in the purchase or management of microcomputers? Yes No

VNU Business Publications BV, FREEPOST 25, London, W1E 6EZ.

Write programs to unlock the multitasking power of your QL!
 Choose the language you need from Metacomco's unrivalled range
 of high-quality languages for the QL: The best selling **ASSEMBLER**;
 The language of the future, **LISP**; and two professional compilers,
BCPL and **PASCAL**.

RELEASE THE POWER OF THE

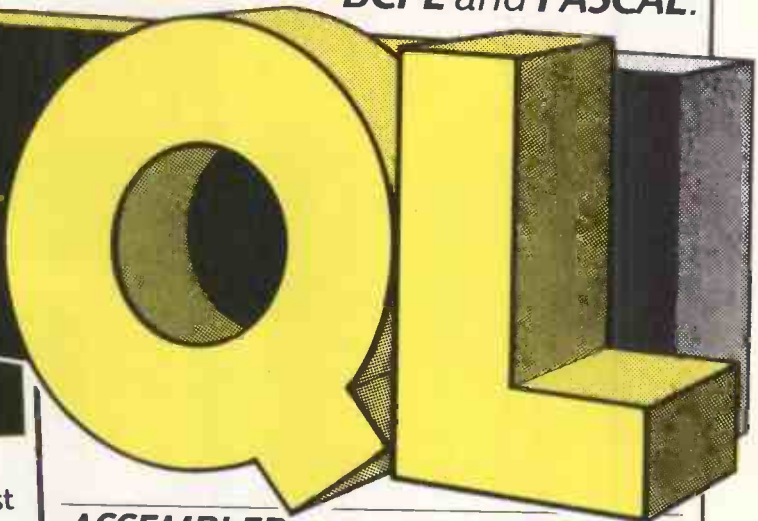

QL PASCAL **£89.95** INC. VAT

Newly available, a true Pascal compiler for the QL!
 Developed by Metacomco: leaders in Pascal - the first
 software house to achieve full ISO validation of a
 Pascal compiler for the 68000. QL Pascal is a high
 specification implementation of this popular language,
 endorsed by Sinclair Research for use on the QL.

- > True compiler producing native 68000 code: compact and efficient.
- > Fast, single pass compilation without intermediate stages.
- > Complete implementation of ISO 7185 - the international standard for Pascal - making it ideal for commercial and educational use.
- > Direct addressing of the full QL address space.
- > Key routines provided on ROM for extra speed and convenience.
- > No run time licences required for commercial applications written using QL Pascal.
- > Any length variable names and full 32-bit integers.
- > Easy to use interfaces to QL windows, graphics, traps, screen handling, file operations, etc.
- > Will handle very large sets and arrays.
- > Approved by Sinclair Research for use on the QL.



The Metacomco Development Kits are available from W.H. Smith, John Lewis, HMV, Menzies, Boots and other leading retailers, or direct from Metacomco.



26 Portland Square, Bristol BS2 8RZ.
 Tel: Bristol (0272) 428781

QL and QDOS are the trade names of Sinclair Research Ltd.

ASSEMBLER **£39.95** INC. VAT

A high specification macro assembler supporting the full Motorola instruction set.

Features: external references; absolute, position independent, and relocatable code; linker; precise error messages; formatted listings; macro expansions; conditional assembly; and a large range of directives.

BCPL **£59.95** INC. VAT

A true compiler, ideal for systems programming - writing utilities, games and applications.

Features: generates native 68000 code; run time library includes easy QDOS interfaces; link loader links separately compiled segments; modules can be linked with Pascal or assembler.

LISP **£59.95** INC. VAT

A LISP interpreter for exploring "The language of artificial intelligence".

Features: Turtle graphics; compatible with LISP for the BBC micro; full support of QL features; structure editor; prettyprinter; garbage collector and tracer.

Every DEVELOPMENT KIT includes Metacomco's popular screen editor, and a detailed manual.

NAME _____
 ADDRESS _____

 POSTCODE _____
 TEL. NO. _____
 SIGNATURE _____

Phone today or post this coupon to:
 Metacomco, 26 Portland Square,
 Bristol BS2 8RZ. Please send me:
 Assembler Development Kit **£39.95** _____
 LISP Development Kit **£59.95** _____
 BCPL Development Kit **£59.95** _____
 QL PASCAL Development Kit **£89.95** _____

I enclose a cheque for £ _____ or
 debit my ACCESS/VISA Account No. _____

CARD EXPIRY DATE: _____

Price includes VAT, postage and packing UK mainland only. Delivery, allow up to 28 days.

PCW10

Exciting new products for your Apricot PC, Xi, FI and Fle!

XF-800: IBM PC COMPATIBLE DISC DRIVE

The **unique** XF-800 floppy disc drive sub-system comprises a slim 40/80 track switchable, double-sided 5.25" floppy disc drive and on-board power supply, with MS-DOS driver software and an interface/controller card that locates in an expansion slot.



The sub-system is thus configured as a second or third drive, as appropriate and has two principle applications:

- **Will format, read and write diskettes for use with the IBM PC, giving total file compatibility. This includes all four principle IBM PC formats.**
- **800k formatted capacity for exclusive operation with the Apricot PC, Xi, FI and Fle.**

XE-6: Six Port Expansion Unit.
Another new **PROFESSIONAL** product from Alpha Disc, **Ex. stock.** The perfect complimentary product to the XF-800, and more...

Features:

- Five usable expansion slots.
- Sits neatly alongside your system.
- Very simple installation.
- On-board power supply.

XF-800	£495 + VAT.
XF-800 (without IBM PC compatibility)	£395 + VAT.
XE-6	£245 + VAT.

A special customer price on an XF-800 plus XE-6 is available on application.

DEALER ENQUIRIES WELCOME



ALPHA DISC LTD

UNIT 2 CRABTREE ROAD THORPE INDUSTRIAL ESTATE EGHAM SURREY TW20 8RN

TELEPHONE (0784) 35357/8/9 TELEX 918886 ALPHAD G.

CAP IT ALL

WITH
Da Vinci of London

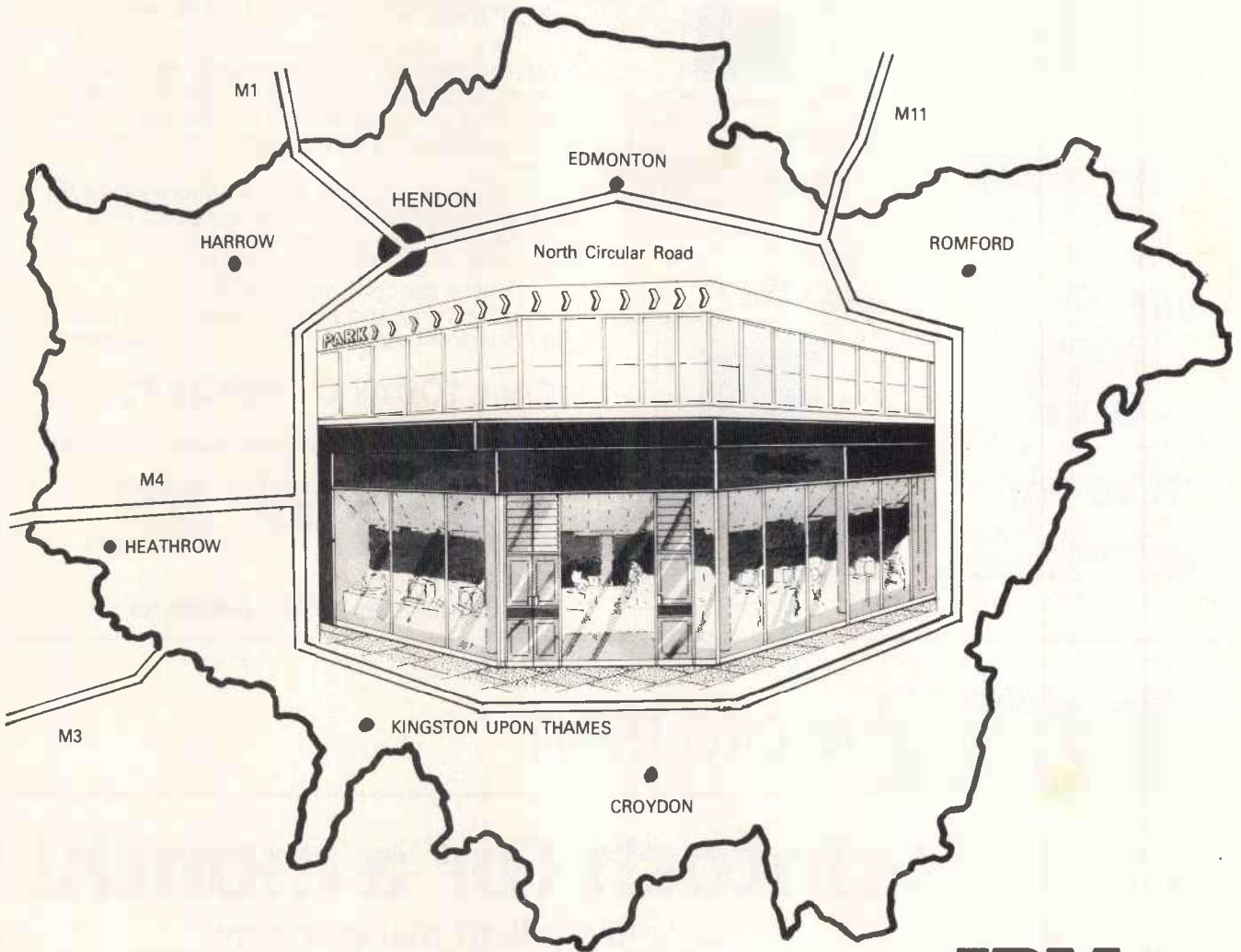

If you look at what is offered by other dealers, you'll find that Da Vinci "Cap It All" around London.

Established for over 6 years in the field of microcomputer sales we have a solid base. Our superb showroom - office - workshop complex is probably the best custom built facility currently available and essential for authorised dealers of all market leaders.

An enquiry to our company, will result in prompt attention from one of our knowledgeable sales executives, and demonstrations can be carried out at either your HQ or ours.

Although not a "warehouse", we know you will find our quotations acceptable, and whether a first - time or repeat purchaser, our advice with regard to hardware and software selection, will always be based upon your individual requirements.

Installation and training can be scheduled precisely, so that your system is up and working for you with the minimum of delay. You'll find our expert maintenance division provides the back-up essential to successful continuity with a short-period call-out contract available, as well as stocks of parts and peripherals and repair service.

If all this sounds too good to be true, we would just like to mention accessibility; 2 minutes from the M1, A1, North Circular Road, A41, nearest Tube station or Brent Cross (drop the wife off); 15 minutes from the M25, 25 minutes from Central London, 40 minutes from Heathrow and an hour or so from the Midlands. We have easy Free car parking to the rear and are open Saturdays as well as weekdays.

We think you'll agree, - DA VINCI CAP IT ALL.

IBM

PERSONAL COMPUTERS

apricot



PERSONAL COMPUTERS

WORDRAFT



**PEGASUS
BUSINESS
SOFTWARE**



**Da Vinci
Computer
Store**

112 BRENT STREET HENDON NW4 Tel: 01-202 2272/3/4
Telex: 265871 (MONREF G) REFER TO 81 MMD102
TELECOM GOLD 81: MMD 102

MIR MICROCOMPUTER RENTAL

From Micro-Rent, Britain's top-value specialist in microcomputer rental.

MACINTOSH
£40 * PER WEEK



APRICOT
£40 * PER WEEK



SIRIUS
£46 * PER WEEK



IBM PC
£46 * PER WEEK



- Try before you buy
- Flexible terms — weekly, monthly, annual
- No capital outlay/Immediate delivery
- Purchase option with rebate of rental

Micro-Rent is Britain's top-value microcomputer rental specialist. You can hire on a short term basis, and give the leading machines a thorough trial in your own office, before deciding on the right one for your needs.

If you already use a micro, Micro-Rent can supply additional machines for short-term projects, or to cover breakdowns. Extra printers or monitors also available.

Micro-Rent is independent of any manufacturer, and offers expert impartial advice on all aspects of microcomputer use.

CALL TODAY 01-833 2531

*Prices quoted are based on 3-month rental, excluding VAT.



OSBORNE
IBM PC
SIRIUS

APRICOT
APPLE IIe
LISA
MACINTOSH

MICRO-RENT

127 Cloudesley Road, London N1

MIR MICRO-RENT

Try a Macintosh for a month!

Micro-Rent makes it easy to try the world's friendliest computer.

Macintosh is the personal computer that surprises everyone — because it is so easy to use, and so amazingly versatile with its range of software.

Now Micro-Rent makes your introduction to simple, fuss-free business computing even easier. Rent a Mac for a month from Micro-Rent for just £175 — including software!

This special offer lets you evaluate Macintosh in your own office and give it a full-scale trial before you decide whether to buy one.

And if you do decide to buy, Micro-Rent even refund your month's rental! Phone now — offer subject to machine availability, closes May 31.

Micro-Rent, Britain's leading business computer rental specialists.

CALL TODAY 01-833 2531



MICRO-RENT Authorised Apple Dealer.
127 Cloudesley Road, London N.1.



Word processing



Graphics

CUMANA Special Price Offers!

SPECTRUM AND SPECTRUM PLUS DISK INTERFACE
Convenience of double density disk operation for only **£99.95**

DELTA INTERFACE FOR YOUR DRAGON
Dragon 32 Disk Controller for only **£49.95**

DISK DRIVE SUITABLE FOR USE WITH APPLE MODELS II & IIE
AS 501 disk drive only **£114.95**

RS 232 BOARD FOR TANDY MODELS III/4 only £39.95
EXTERNAL HARD DISK FOR TANDY MODELS III/4 (5MB)
only **£895.00**

WESTERN DIGITAL WD 1005.1 CONTROLLER CARD
for only **£114.95**

Z 80 DISK PACK Cumana price only **£599.95**

CUMANA CSX 351 3 1/2" single drive without power supply only **£79.95**
CUMANA CDX 352 3 1/2" dual drive without power supply only **£139.95**

THE SUPER MCP 40 COLOUR PRINTER/PLOTTER
compatible with the BBC/Dragon/Tandy only **£69.95**

TH 1603 A Spectrum compatible data cassette recorder £19.95
TH 1603 C Commodore compatible data cassette recorder £19.95
TH 1603 H BBC compatible data cassette recorder £19.95

Limited offer, all products are subject to availability. All prices are inclusive of V.A.T.

Apple is a registered trademark.
Tandy is a registered trademark.
Spectrum is a registered trademark of Apple Computer, Inc.

ORDER FORM (SPECTRUM OFFER)

To: CUMANA LIMITED, THE PINES TRADING ESTATE, BROAD STREET, GUILDFORD, SURREY GU3 3BH TEL: 0483 503121

Please rush me:

I enclose cheque/PO* for

NAME or debit my access/visa* card no.

ADDRESS

*Delete as applicable



ORIC AND SINCLAIR COMPUTERS



MCP40 Oric printer/plotter £109 (£110) £122. Sinclair pocket TV £97 (£95) £101. Sinclair QL Computer £379 (£378) £399. QL Floppy disk interface £107 (£103) £109. 3.5" disk drive to suit this interface £177 (£176) £196. Sinclair Spectrum Plus Computer 48K £127 (£129) £149. Kit to upgrade the Spectrum to Spectrum Plus £30 (£30) £40. Microdrive £49 (£50) £60. RS232 interface 1 £49 (£50) £60. Special offer: Microdrive + interface 1 + 4 cartridges £97 (£99) £107. Blank microdrive cartridges £2.50 (£3) £4. Spectrum floppy disk interface (See Cumana disk section for suitable disk drives) £97 (£89) £99. Interface 2 £20.45 (£20) £24. 32K memory upgrade kit for 16K Spectrum (issue 2 and 3 only) £31 (£28) £30. Spectrum Centronics printer interface £46 (£42) £47. ZX printer has been replaced by the Alphacom 32 £71 (£69) £82. 5 pinner rolls (State whether Sinclair or Alphacom) £13 (£16) £21. ZX81 computer £35 (£35) £45. 16K ram packs for Z81 £28 (£25) £30.

COMMODORE COMPUTERS

Commodore C16 Starter Pack £119 (£119) £151. Commodore 64 £189 (£194) £226. Converter to allow most ordinary mono cassette recorders to be used with the Vic 20 and the Commodore 64 £9.78 (£9) £11. Commodore cassette recorder £43 (£44) £50. Centronics printer interface for Vic 20 and the Commodore 64 £45 (£41) £46. Disk drive £197 (£201) £232.

ACORN COMPUTERS

Acorn Electron £119 (£119) £139. BBC Model B £354 (£343) £383. BBC Model B with disk interface £474 (£461) £491. New BBC Model B Plus £497 (£484) £514. See below for suitable disk drives. Colour monitor £188 (£229) £268.

AMSTRAD, ATARI AND ENTERPRISE COMPUTERS

Amstrad colour computer £342 (£348) £388. Amstrad green computer £232 (£247) £287. Atari 130XE computer £158 (£163) £183. Atari 520ST computer £634 (£616) £656. Atari 800XL computer + recorder £120 (£123) £143. Atari 800XL Computer + disk drive £229 (£230) £260. Atari data recorder £34 (£37) £47. Atari disk drive £172 (£171) £191. Atari 1020 printer £93 (£99) £115. Enterprise 64 computer £172 (£170) £190. Enterprise 128 £233 (£229) £249.

CUMANA DISK DRIVES

To suit disk interfaces of Sinclair QL, Spectrum, and BBC B. Single: 40 track single sided £164 (£163) £183. 40 tr double sided £169 (£168) £188. 80 tr ds £219 (£209) £229. Dual: 40 tr ss £294 (£280) £320. 40 tr ds £325 (£325) £365. 80 tr ds £414 (£390) £430.

PRINTERS



MCP40 4 colour printer/plotter £109 (£110) £122. Brother HR5 £162 (£161) £193. Brother M1009 £218 (£214) £245. Shinwa CTI CPA80: centronics parallel version £218 (£222) £256. RS232 version £238 (£240) £282. Cannon PW1080A £312 (£308) £358. Epson RX80 £249 (£249) £282. Epson FX30FTT + £283 (£281) £316. Epson FX80 £429 (£420) £450. Combined matrix printers and electric typewriters: Brother EP22 £135 (£124) £144. Brother EP44 £230 (£226) £246.

BUSINESS COMPUTERS

Epson PX8 £900 (£872) £892. Commodore PC10 £1595 (£1564) £1664. Commodore PC20 £2573 (£2485) £2685. Sanyo MBC 775 £1920 (£1899) £1999. Cannon A200C £1609 (£1586) £1686. Sanyo MBC550 £723 (£699) £799. Sanyo MBC550-2 £975 (£939) £1039. Sanyo MBC555-2 £1343 (£1322) £1422.

SWANLEY ELECTRONICS

The Computer Export Specialists

Dept PCW, 32 Goldsel Rd, Swanley, Kent BR8 8EZ, England

Tel: SWANLEY (0322) 64851. Official orders welcome. UK prices are shown first and include post and VAT. The second price in brackets is for export customers in Europe and includes insured airmail postage. The third price is for export customers outside Europe (including Australia etc) and includes insured airmail postage.

EPSON

HX-20 **PX-8** **QX-10**

As one of EPSON's largest dealers we sell service and support their full range. For quality, style and reliability they are hard to match. Write for our full list and ex-demo and specials list.

COMMUNICATIONS

Acoustic and Direct Connect Modems for all asynch speeds including electronic mail and viewdata. Prices from £79.

CX-21 **MS-21/23**
BUZZ BOX **MM-101**

DATA CAPTURE

PF-10 **PIXIE**
HT-5000

We have supplied many hundreds of terminals for data capture for sales men, shops or depots and can get your data into most micros, minis and mainframes over telephones. Call us to discuss your applications.

PRINTERS

We supply famous EPSON printers for all makes of computer. The LQ1500 for instance prints Near Letter Quality at 67cps and Draft at 200cps. The incredible P-40 costs only £87 (ex VAT) and prints up to 80 characters per line and BARCODES.

P-40

ACTIL is a new concept in Retail Systems.

A general purpose, battery powered CPM microcomputer which looks like a bill, but also does accounts, stock control, order entry and communicates. Ideal for small shops, video libraries and market traders, as well as larger groups.



The Computer Centre,
Bugbrooke Road, GAYTON,
NORTHAMPTON NN7 3EU.
TEL: (0604) 858011.

IF YOU SHOULD BE TALKING TO ICL DO IT THROUGH TANGOGATE

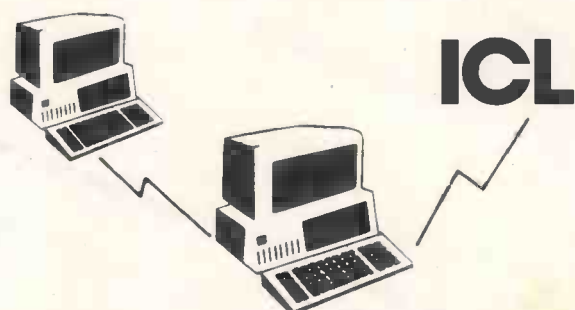

TANGOGATE enables single or networked microcomputers which run under Concurrent CP/M™ to integrate into synchronous communication networks using CO1/CO3 protocols.

FROM THE PEOPLE WHO GAVE YOU TANGOLYNK

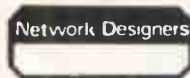

The Old Berkshire Hunt Kennels
Kingston Bagpuize
Oxon OX13 5AP
Telephone (0865) 821177

™Trademark of Digital Research Inc.

PRACTICAL PRINTER STANDS— SENSIBLE PRICES

- Makes paper management simple and easy
- Stands neatly on a desk top
- Supply paper locates below the printer; reduces sprocket tear and can stay in its carton
- Stands are complete with tray; sturdy construction throughout
- Quantity discounts on application

Order direct or ask for brochure

AR15
For most makes of 80 character printers; steel construction finished brandy white
ONLY £32.20
incl. VAT and delivery (UK mainland only)

AL24
For most makes of 132 character printers; aluminium stand with black tray
ONLY £59.80
incl. VAT and delivery (UK mainland only)

To: Advanced Resources, St. Gabriels, Much Birch, Herefordshire, HR2 8HY
Tel: (0981) 540262

NAME:	PLEASE SUPPLY	Qty	Price Each	Total
COMPANY:	Model AR15		£32.20	
ADDRESS:	Model AL24		£59.80	
POST CODE:	Grand Total			

TEL. NO: _____

Please send cheque with order PCW/B/85
or include your ACCESS/BARCLAYCARD No: _____

Discount Micros!

SAVE HUNDREDS OF £££s

on the BEST RANGE OF MICROCOMPUTERS at the BEST PRICES!

RECOMMENDATION? RELIABILITY? ... 40% REPEAT BUSINESS!!!!

PRINTERS
*
MODEMS

SOFTWARE
*
PERIPHERALS

IBM PC

— Full system

64K System Unit
2 x 320K Drives
Keyboard
High Res. Monitor



~~£2000~~

£1598*

COMPAQ™

(Fully IBM compatible portable computer)

— Full System

256K System Unit
2 x 320K Drives
Colour interface
Keyboard
High Res. Monitor



~~£2200~~

£1698*

apricot

— Full system

256K System Unit
2 x 315K Drives
Keyboard
High Res. Monitor



~~£1800~~

£1398*

Including a range of software FREE

Macintosh

128K
Keyboard
High Res. Monitor

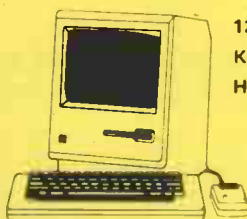

~~£1800~~

£1398*

SANYO MBC 550

128K System Unit
1 x 160K Drive
Keyboard
Spread Sheet
Wordstar



~~£800~~

£598*

olivetti M24

IBM Compatible
128K RAM
2 x 320/360K Disc Drives
Monitor
Keyboard, etc.



~~£1939~~

£1498*

* **COMMODORE PC**

* **KAYPRO**

* **SIRIUS**

*

APRICOT

XI 256K 10MB + Mon	£2348
XI 256K 5MB + Mon	£2148
PC 256K, 2 x 720K + Mon.	£1598
PC 256K, 2 x 315K + Mon.	£1398
FI 256K, 1 x 720K + Mon	£1048
Flc 128K, 1 x 315K + Mon.	£848

OLIVETTI

M24 PC + Mon	£1498
M21 Portable	£1498
M10 Lap held	£359

IBM PC

128K 'XT' 10MB	£2998
128K 'XT' 10MB Colour	£3298
64K 'PC', 2 x 320K	£1598
64K 'PC', 2 x 320K Colour	£1898

COMPAQ

256K, 10MB	£2999
256K, 2 x 320K	£1698
Deskpro 2	£2095

NEW

**Kaypro A.T. Compatible
£3299!!!!**

APPLE

Macintosh 128K inc. Mon.	£1398
Macintosh 512K inc. Mon	£2199
Ile 64K + Mon	£599

SANYO

MBC 550 (128K, 1 x 160K)	£598
MBC 555 (128K, 2 x 160K)	£798
MBC 550 (1 x 360K)	£798
MBC 555 (2 x 360K)	£1098

3

YEARS PEACE OF MIND PROTECTION AGAINST*

- Breakdown, theft, etc.
- Loss of data
- Cost of hiring another machine
- Insurance in transit

*Option available

Other machines on request.

To place your order for IMMEDIATE DELIVERY, call Vanessa on **01-938 2151** (20 lines)

*Offer lasts for limited period only and is subject to VAT and change without notice!

Discount Micros Ltd.
7 Kensington High Street, London W.8.

Please send me

Quote on Information on Ring me

Urgent

Name _____ Title _____

Company _____

Address _____

Postcode _____

Phone _____ Extension _____

PCW/8/85

EXPORT SPECIALISTS

NOBODY KNOWS AS MUCH ABOUT COMMUNICATIONS AS THE BYTE SHOP



Communication is something The Byte Shop is quite expert at. Communication between person and person. Machine and machine. Man and machine.

More companies recognise this today which is why fewer and fewer are investing in 'stand-alone' computer systems.

Now the emphasis is on networking capabilities. It's an aspect that gives more people more access to computers so they can interchange ideas and information.

The Byte Shop has the expertise to provide objective advice on networking as well as a broad spectrum of computer related topics.

We will assess your current needs and future requirements. We can also install and commission your complete system. Help you make the right choice of application software. Train your staff and supply that all important service and technical back-up.

At The Byte Shop you'll get a system that suits your needs and your budget. Send for our free brochure, 'Where can you count on getting the right Business Computer?', simply complete and post the coupon.

Authorised Dealers of IBM PC, Comart, Compaq and Data General.

The BUSINESS COMPUTER CENTRES
BYTE SHOP

 A Kode International plc Company

Head Office: The Byte Shop Limited, Grove House, Little Paxton, Cambs. PE19 4EL. Telephone: 0480 218812. Telex: 32514G

To: The Byte Shop Head Office, FREEPOST, Grove House, Little Paxton, Cambs. PE19 4BR (No stamp required)

Please send me copies of your brochure

Name

Company

Position Tel

Address

PCW

BYTE SHOP NATIONWIDE BUSINESS CENTRES: LONDON (01) 387 0505 · BIRMINGHAM (021) 622 3165 · GLASGOW (041) 221 8202
MANCHESTER (061) 236 4737 · NOTTINGHAM (0602) 470576 · SOUTHAMPTON (0703) 334711

The **XLtron**

MEGA•BOX

from Disco•Tech (UK) Ltd.

The MEGA BOX is a top quality rigid plastic storage box with see-through lid and four dividers. Holds up to 60 diskettes.

All disks are 5¼" and feature:

- Write protect notch
- Hub rings
- Double density (D/D) suitable for single density (S/D)
- Tyvex sleeves
- Full set of labels and write protect tabs
- Meets all ANSI specifications



Floppy Disk Price

25 SS/DD disks in MEGA•BOX £4.35 and £2 p&p = £35.35
 25 DS/DD disks in MEGA•BOX £5.85 and £2 p&p = £41.35
 50 SS/DD disks in MEGA•BOX £8.35 and £2 p&p = £71.35

SUMMERTIME SPECIALS

TIME TO BUY

- 25 SS/DD DISKS AT ONLY **£25** inc VAT (40 Track 48 TPI)
- 25 DS/DD DISKS AT ONLY **£31.25** inc VAT (40 Track 48 TPI)
- 25 SUPERDISKS AT ONLY **£35.95** inc VAT (SUPERDISK DS/DD 80 Track 96 TPI)

• ABOVE SPECIALS PACKED IN HERMETICALLY SEALED PACKAGES. POSTED IN EXTRA HEAVY BOXES. FIRST CLASS POST 48 HOUR DELIVERY.

• PRICE INCLUDES VAT AND SHRINK WRAPPING. TO QUALIFY YOU MUST USE THE COUPON BELOW (OR A COPY OF IT), OR MENTION IT IF YOU RING. ONLY ONE PACK PER ADDRESS.

• ABOVE ORDERS PLUS £2 POST & PACKING. ALL ABOVE PACKAGES INCLUDE WRITE PROTECT TABS AND LABELS

Quality Guaranteed

The XLTRON quality control is so stringent that we can give our famous 'two for one' guarantee. If you find a faulty disk, return it to us, and we'll send you two in exchange immediately. All part of our five year guarantee.

© TYVEX is a registered name of Du Pont.
 © Rhinokote is a registered name of Rhino Magnetics Ltd.
 © XLTRON is a registered name of XLTRON Ltd.

Now established in our new showroom in Alfred Place. You can save our £2 delivery charge by calling in - you'll be welcome weekdays from 10.00am till 5.00pm Saturday 10.00am-4.00pm.

Help Lines

01-631 0255
 01-631 3600

If you want help or information to place an order just ring our 'help' lines.

Official Orders

We accept orders from all government bodies, schools, universities, libraries, armed forces etc. We despatch on receipt of an official purchase order. If you can't raise a cheque without an invoice, just post or telephone your order and we'll send you a pro-forma by return.

To: Disco•Tech (U.K.) Ltd., Lex House, 3-6 Alfred Place, London WC1, England

Just fill in the coupon or send your order on a postcard or letter. Or phone your order on 01.631 3600 OR 01.631 0255.

Please send me the following (tick the appropriate boxes):

- 25 ss/dd disks at only £25 inc VAT
 - 25 ds/dd disks at only £31.25 inc VAT
 - 25 ds/dd disks at only £35.95 inc VAT
- } + £2 p&p

I enclose a cheque/p.o. for £ _____ or debit my Access/Diners/Amex card

Card no. _____

Name: _____ Signature: _____

Address: _____

(Block Capitals Please) _____ Postcode: _____

Disco•Tech (U.K.) Ltd.,
 Lex House, 3-6 Alfred Place,
 London WC1, England.

Disco•Tech (U.K.) LTD. are the
 sole distributors of XLTRON.

RITEMAN



Riteman F Plus with 80 column, 105 cps and Epson FX 80® compatibility



Riteman II features 80 column, 160 cps and Epson FX 80® compatibility
Riteman Blue Plus with 80 column, 140 cps and IBM® PC® compatibility

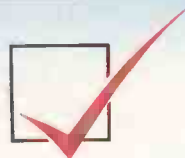

Riteman 15 with 136 column, 160 cps and Epson FX 100® compatibility



C. Itoh's Riteman range of printers – the Rite choice in low cost printers.

The Riteman range, available from C.Itoh, brings you big printer performance in units which set new standards for compact, reliable printers.

Whether you need a lightweight, full-featured or high-speed multi-mode commercial model, the Riteman range offers the print speed, quality and reliability you need.

Riteman

F Plus low cost dot matrix printer with 105 cps print speed, is compatible with Epson FX 80®, and with its unique paper handling and stacking system the Riteman F Plus uses the minimum of space in operation.

Riteman

Blue Plus is specifically designed to complement the IBM® PC®, and is compatible with all three of the most popular modes of operation: IBM® Graphics Printer, Epson RX 80 FT®, and MX 80 FT®. You even get quad density mode for quality graphics.

Riteman

II gives 160 cps performance in a unit small enough to fit in a 3 inch deep briefcase. Features include 2k buffer and expandable 8k buffer, 256 programmable character modes, proportional spacing, and Epson FX 80® compatibility.

Riteman

15 is a 15 inch wide paper, 136 column printer which delivers 160 cps. Features include six graphics modes, 128 typesets, and nine sets of foreign characters. The ideal business machine, it is also Epson FX 100® compatible.

All models, except Blue Plus, feature NLQ print-mode for word processing applications.

IBM and PC are registered trademarks of International Business Machines. Epson RX80 FT, MX 80 FT and FX 100 are registered trademarks of Epson Corp.



THE LOWEST PRICES IN PRINT

And that's a fact!

See for yourself by making sure you get on the Mancos Trade Warehouse mailing list. Our Pricelist is published every 6 weeks with all the latest at the lowest prices. Our stocklist includes:

MATRIX PRINTERS

Digital ■ Dataproducts Paper Tigers ■ Epson ■ OKI Microline
Smith Corona ■ NEC Pinwriter ■ Mannesman Tally

LETTER QUALITY AND LINE PRINTERS

Uchida ■ Dyneer ■ Brother ■ NEC Spinwriter ■ Dataproducts full range

VDUs AND MONITORS

Wyse ■ Tatung ■ Digital ■ Hazeltine ■ Microcolour Graphics ■ Dyneer

GRAPH PLOTTERS

Gould ■ Hewlett-Packard

PLUS A FULL RANGE OF COMPUTER FURNITURE

GET ON OUR MAILING LIST - HUNDREDS OF GREAT BARGAINS EVERY MONTH

MANCOS COMPUTERS

TRADE WAREHOUSE

Action Line

018405666 0618610757

TOP-LINE CHOICE / BOTTOM-LINE PRICES

Mancos Computers, Unit 3, Albany Road Trading Estate, Manchester M21 1BH

X T CONVERSION KITS FOR IBM® AND COMPATIBLES

NEW FAST CONTROLLER!

WESTERN DIGITAL 1002 SWX-2

ST-506 STANDARD.....£249

MR 521 HALF HEIGHT, 5¼"

10MB WINCHESTER DRIVE (FORMATTED)

2-HEADS, AVERAGE 85ms ACCESS..... £399

MR 522 HALF HEIGHT 5¼" 20 MB

WINCHESTER DRIVE (FORMATTED)

4 HEADS, AVERAGE 85ms ACCESS.....£579

UPGRADE 130 WATT POWER SUPPLY£149

SET OF CABLES FOR ABOVE.....£25

RAM CHIP SALE!!!

4164 64K DRAM 150ns £1.99 each

4128 128K DRAM 150ns..... £7.49 each

(for upgrade IBM AT)

41256 256K RAM 150ns..... £5.99 each

(for upgrade Olivetti-M24, Compaq Deskpro etc)

Prices exclude VAT and delivery. For terms see our other advertisements.

DIGITASH
BUSINESS SYSTEMS LTD
55, MAPLE DRIVE, EAST GRINSTEAD, WEST SUSSEX, RH16 3UR

TEL: (0342) 24631•313427
TLX: 957547



APPLE MACINTOSH WE ARE THE EXPERTS

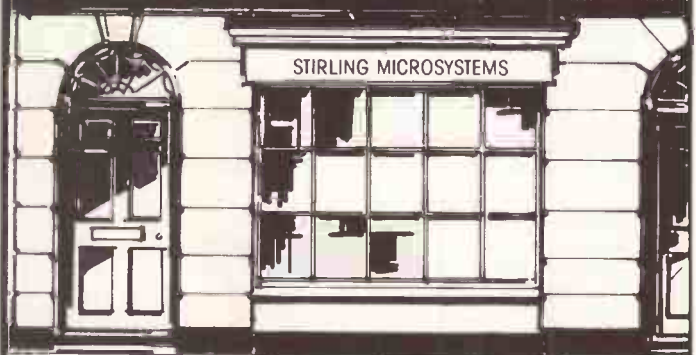

Stirling Microsystems are London's Apple Macintosh specialists. Choose from our extensive range of computers, disk drives, printers and the hundreds of business and leisure software packages that are all available ex stock.

STIRLING MICROSYSTEMS

THE BUSINESS COMPUTER STORE

231 BAKER STREET, LONDON NW1 6XE

TELEPHONE: 01-935 5262

OPEN MONDAY-FRIDAY 9.30 AM-6.00PM



MACOB

MAIL ORDER WITH A DIFFERENCE

SYSTEMS

DIRECT TO YOU AT WHOLESALE PRICES

COMPUTERS

BBC-B	£329
BBC-8D	£419
BBC-B+	£489
DFS (Acorn)	£90
Z80 2nd Processor	£389
6502 2nd Processor	£189
CBM 64	Available for export
Sinclair	

MONITORS

Microvitec 1431	£185
Microvitec 1451	£279
Philips BM7502	£83

DISKS

D/S D/D 80T	£20 (box of 10)
(Fully guaranteed box of 10)	

PRINTERS

Canon PW1080A	£279
Canon PW1156A	£389
Kaga KP810	£279
Epson RX80F/T	£242
Quendata 20cps	£239
Juki 6100	£332

MODEMS

Pace Nightingale	£130
------------------	------

DISK DRIVES

Cumana CSX100 SS 40T	£103
Cumana CSX400 DS 40/80T	£155
Cumana CD200 SS 40T + PSU	£242
Cumana CD800 DS 40/80T + PSU	£356
PSU	£20

FIRMWARE

View	£48
Wordwise +	£48
Disc Doctor	£29
Printmaster	£29

DATA RECORDERS

Omega	£21
-------	-----

- Price includes VAT at 15% and delivery is FREE in the UK.
- To order just send a cheque or postal order to us and the goods reach you fast.
- Trade enquiries welcome.
- Remember, our name is our guarantee.

MACOB SYSTEMS

8 Lister Gardens, London N18 1HZ. Tel: 01-803 1622

Telex: 8954029 att.MACOB



Appointed Dealers for
ITT XTRA, PEGASUS,
LOTUS
SYSTEME, PSION,
XCHANGE

We offer a complete service including comprehensive demonstrations, installation and training. On site maintenance contracts can be arranged.

BUSINESS COMPUTERS

Apricot F1	995
Apricot PC 315K Twin with monitor	1595
Apricot PC 720K Dual with monitor	1795
Apricot Xi 10 10Mb with monitor	2795
ITT XTRA120 256K 2xD/S disk with monitor	2320
ITT XTRA130 256K 1xD/S diskette 10Mb with monitor	3430

PRINTERS

Brother M-1009	174	Epson RX100	422
Canon PW1080A	280	Epson FX100	519
Epson RX80F/T	243	Juki 2200	260
Epson FX80	412	Juki 6100	349

Penman Plotter prices from £249
All prices exclude VAT

Business software available including Pegasus, Lotus, Multiplan, Volkswriter, and many others.

We accept official orders from UK Government and Educational Establishments.

Export enquiries welcome.

Leasing available. Ask for written details.

Showroom opening hours: MON-SAT. 9.00am-5.30pm

MIRAGE MICROCOMPUTERS LTD
24 Bank Street Braintree Essex CM7 7UL
Telephone Braintree (0376) 48321

Low-cost Acoustic Couplers

FROM

£85

+ p & p + VAT



An unbeatable range of completely portable, instantly useable, highly reliable Acoustic Couplers — at astoundingly low prices.

3005 Originate only mode CCITT V21 with external power supply unit. Diagnostic LEDES. Standard V24/RS232 interface. Durable aluminium case. In-built current loop interface. Digital filter for minimum error. Unique cup design fits almost any phone.

3005-1 As above plus switch for originate and answer mode.

3005-2 As 3005-1 plus internal rechargeable battery

3005-3 As 3005-2 plus external switch controls V21 or Bell 103

3012 Originate only CCITT V23, 1200/75 or 1200 half duplex

APPROVED for use with telecommunication systems run by British Telecommunications in accordance with the conditions in their specifications for use in this respect for use

Please send me _____ 3005 at £103.50; _____ 3005-1 at £109.25;
_____ 3005-2 at £115.00; _____ 3005-3 at £119.60; _____ 3012 at £115.00.
All prices are inclusive of £5 p&p and VAT.

NAME _____

ADDRESS _____

TEL: _____ PCW/8/85

I enclose my cheque for £ _____
Modular Technology Ltd., Zygal House,
Telford Road, Bicester, Oxfordshire. OX6 0XB
Tel: Bicester (0869) 253361 Telex: 837907



 **SANYO**
Micro users
association



**Important
News for**



**micro
owners**

The SMUA are pleased to invite all its members to Stand 1003 at the Personal Computer World Show, from 4-8 September.

Sanyo users who are not members are also invited to see us at the stand.

FREEPHONE SMUA

لتزويد منازلكم بوسائل حديثة للمعرفة

اسعار
جديدة

٩٩٥
ريالا

كمبيوتر
عرب وايم



وصلت حديثاً..
• جهاز (٥٤) يبلغ ١٩٩٥ ريالاً سعودياً
• عرب م ٤٠٠ ريال سعودي
• ذاكرة سعة ٤٨ كي
• ٦٩٥ ريالاً سعودياً

أدخل وعائلتك عالم الوسائل التعليمية والترفيهية الحديثة..

باللغتين العربية والانجليزية.. باقتناء أجهزة الكمبيوتر سنكلير عرب وايم الملونة الرائعة..
كمبيوتر سنكلير جهاز مدمج ومحكم الصنع.. يمكن لأي شخص استخدامه
في المجالات التعليمية - العملية - الترفيهية..

لغة كبيوتر خاصة **سعودية** يمكن توصيله بأي جهاز تلفزيون وتسجيل
ذاكرة سعة ٤٨ كي - مع كمية من عناصر البرمجة التشغيلية، الكتب،
معدات إضافية لاستعمالات عديدة..

سنكلير

أكثر أجهزة الكمبيوتر شعبية في العالم العربي

- | | | |
|------------------|-----------------|-----------------------|
| بكويت : ٤١٢٤٠٤ | برية : ٣٤٤٧٣٦ | الرياض : ٤٠٥٩٨٥ |
| بيروت : ٣١٣٩٥١ | عنز : ٣٦٤٤١٩٢ | مكة المكرمة : ٥٤٤٥٦٢٣ |
| قطر : ٤٢٨٥٥٥ | بغداد : ٧٤٥٣٢٨٧ | النجف : ٨٦٤٦٧٨٧ |
| البحرين : ٥٣٤٤٦ | بغداد : ٧٦٤١٥٦٠ | النجف : ٨٩٥٢٩٩٨ |
| البحرين : ٢٢١٥٨١ | بريد : ٣٢٣٥٠٦٢ | النجف : ٨٤٢٠٢١٥ |
| عمان : ٧٠٣٧٧٧ | بغداد : ٨٢٨٦٦٨٣ | النجف : ٥٤٤٢٦٦٦ |
| طرابلس : ٦٤١٢٢١ | بغداد : ٥٤٥٢٥٩٢ | |
| الشرق : ٨٠٢٢٣٨ | | |

تليفون خاص لاستفسار بيلت فقط بكلمة : ٥٤٥٢٥٩٢



جهاز الكمبيوتر الوحيد عرب وايم الذي يباع ويصان في المملكة العربية السعودية والشرق الأوسط بواسطة
رصد من المملكة العربية السعودية فقط..
ص ب : ١٤٧ جدة (٢١٤١) المملكة العربية السعودية
تليفون : ٤٠٢٢٧٦ ، ٦٦٥٣٧١٥ (٠٢) ، تليفكس : ٤٠٢٢٧٦

The complete computer store...

Word Processing ■ Communications ■ Data Management ■ Business systems

Consultancy Installation Training Support

Business and Professional Systems
(0223) 65334/5

Engineering Support Group
(0223) 316045

Home and Educational Computing
(0223) 358264

Communications, Electronics, Supplies
(0223) 68155



Sinclair Tandy EPSON KAYPRO SANYO



Cambridge Computer Store
I & 4 Emmanuel Street, Cambridge CBI 1NE

Rockfort Disk Storage System



**M.F. 10
Floppy
Disk Box**
Holds 10 –
5¼" Disks
£2.45
Incl. VAT, Post
& Packing

REG. DESIGN



**M.F. 50
Floppy
Disk Box**
Holds 50 –
5¼" Disks
£9.50
Incl. VAT, Post
& Packing



**M.D. 12/30
Micro
Disk Box**
Holds 12 to 30 –
3½" Disks according
to thickness
£7.85
Incl. VAT, Post
& Packing

Rockfort Diskfile Range of products not only offer an easy reference and attractive disk filing system but also offer complete protection from damaging dust particles. Post for your order today!

 **ROCKFORT
DISK STORAGE**

Manufactured by Projectron Ltd – Trade inquiries invited

PCW 8-85

ROCKFORT PRODUCTS – Member of the Vignesh Group, 30 Topsfield Parade, London, N.8. Tel: 01-348 0543

CODE NO.	DESCRIPTION	QTY.	PRICE	
			£	P
M.F. 10	5¼" DISK BOX			
M.F. 50	5¼" DISK BOX			
M.D. 12/30	MICRO DISK BOX			
TOTAL				

PLEASE FORWARD THE ROCKFORT DISK BOX/S AS INDICATED ABOVE. I ENCLOSE CHEQUE VALUE £ _____

NAME _____

ADDRESS _____

POSTCODE _____

All £250
printers
print
like this.

Only the Epson LX-80 also prints like this.

The print on the left is certainly legible, which is quite good enough for most purposes.

But it's nothing to write home about. Or with.

That's why Epson have brought out the new LX-80.

The LX-80 is a dot matrix printer that can print in correspondence quality (like this) as well as in draft. Yet at only £255+VAT it's no more expensive than any of its less capable rivals.

This alone would make the LX-80 unique. But there's more.

Changing fonts on the LX-80 doesn't involve a complicated rigmarole as it does on other machines. By simply pressing a combination of buttons on the front, you can change from one font to another to another to another. As easily as that.

The LX-80 will justify or centre type if you like. It will even print your own symbols.

Alternatively, you can use the standard 1K buffer to free your computer for other tasks more quickly.

The LX-80 takes plain sheets as standard, though a variety of paper feed options are also available.

It should go without saying that the LX-80 is as reliable as Epson printers have always been. But there, we've said it anyway.

There's still more to tell, of course. But fill in the coupon - in whatever style you like - and we'll fill you in completely.



EPSON

Please send me more information on the LX-80. PCW.8.LX-80

Name _____ Address _____

_____ Tel No _____

To: Epson (UK) Ltd., Dorland House, 388 High Road,
Wembley, Middlesex, HA9 6UH.

NO TEETHING TROUBLE.



NO GROWING PAINS.

Most accounting programs fall between two stools - too complex for the fledgeling business, too basic for the growing concern. But not Sage.

Our new, improved family of compatible computer programs will take your brainchild through from first steps to full maturity. You can cut your teeth on a system that's simple to learn and use, then upgrade easily as you grow bigger and stronger. It's the most up-to-date accounting program on the market - the result of extensive research and improvement, embodying three years of customer feedback.

We've made computer operation even easier and incorporated colourful graphic displays, yet each program still uses only one disk! It's Sage ingenuity at its best. At a price that won't stunt your growth!

SAGE BOOKKEEPER £295 + VAT

The computer program which keeps books for small businesses and cash traders. Start here and grow with SAGE.

SAGE ACCOUNTANT £495 + VAT

A full feature bookkeeping/accounting system to put you in full control of your business.

SAGE ACCOUNTANT PLUS £695 + VAT

The next step up from the Accountant, for the small to medium size business with an above average invoice output.

SAGE FINANCIAL CONTROLLER* £995 + VAT

Top of the Sage range of computer accounting programs. Bring the full power of a hard disk computer to bear on your business.

SAGE PAYROLL £195 + VAT

A full-feature payroll/personnel system which will completely automate the payroll function for companies of all sizes.

NEW, IMPROVED ACCOUNTS PACKAGES FROM SAGE

SAGE SOFT

Please send me more details of Sage Accounting Programs and my nearest dealer

Name: _____ Position: _____

Type of Computer: _____

Company: _____

Address: _____

Tel: _____

Sagesoft plc., NE1 House, Regent Centre, Newcastle upon Tyne NE3 3DS
Tel: 091 284 7077. Telex: 53623 SAGESL G.

BETTER SAGE THAN SORRY

PCW/8/85

*Available 4th qtr. '85

LASKYS ON THE AND AS SILLYSAL

Now – You can see the biggest and best range of computer software demonstrated – on video tape!

Every Laskys store is now showing a 40 minute video tape featuring a selection of new home computer games from the top publishing names. *This will be your opportunity to be the very first to hear about new titles which are about to be launched.*

The video show includes everything from arcade games, action/adventure and simulation programs to graphics – and other practical packages. The products will be tied together by a voice-over to produce a spoken document of news and features. There will also be up-dated reviews, and previews of future releases.

Top names being featured are all distributed by Thorn EMI Software and include:-

**ANIROG, OCEAN, ACTIVISION,
AUDIOGENIC, US GOLD, FIRE-
BIRD, HEWSON CONSULTANTS,**

DATABASE, MARTECH AND MELBOURNE HOUSE.

The first production will be in the stores from July 15 so look out for it!

STOP PRESS! LASKYS NOW STOCK BUSINESS PROGRAMMES FOR THE TORCH GRADUATE (IBM compatible).

Torch products are available at the following Laskys branches:
Central London (42 and 257 Tottenham Court Rd., W1),
Aberdeen, Birmingham, Brent Cross, Brighton, Cardiff, Cheltenham,
Croydon, Ealing, Edinburgh, Enfield, Glasgow, Leeds, Manchester,
Newcastle, Nottingham, Peterborough, Preston and Sheffield.

UP TO £1,000 INSTANT CREDIT. Ask one of our sales staff for full details. Laskys Credit Brokers. Typical Budget Account A.P.R. From 31.3% variable.

All credit offers subject to acceptance by Laskys Credit Brokers. Ask for written details. Typical APR 31.3% subject to status. Prices correct at time of going to press. All offers subject to availability.

GO SOFT AND ENVI SOME PRICES



NOW IN STOCK - VERBATIM DATA LIFE DISKETTES

MD 525-01 (Ten Pack) | MD 350-01 (Ten Pack)
MD 550-01 (Ten Pack) | MD 360-01 (Ten Pack)
MD 525-01 (Twin Pack)

LASKYS SUMMER SALE STARTS JULY 20th

Big discounts off

ATARI · ACORN · COMMODORE · SINCLAIR ·
CUMANA · MICROVITEC · BROTHER · JVC ·
TORCH · APPLE - and many others

but hurry - Sale must end August 10th

Best price promise

If, after purchasing ANY ITEM at LASKYS you discover that you could have bought the same product cheaper locally and call back within 7 days, we promise to pay the difference.

Best products

TOP BRANDS: All the leading brand names. BIGGEST RANGE: See the latest models in Hi-Fi, Video, Computers, Microwaves and Accessories.

Best service

HEAR any combination of our Hi-Fi Separates.

SEE our range of TV's and Video's in action.

FREE 14 day exchange period.

FREE GUARANTEE up to 2 years with the option to extend up to 5 years for a small premium*.

INSTANT CREDIT up to £1,000.†

PAYMENT OPTIONS: cash, cheque, major credit cards.

Plus expert after-sales service from our Servicepoint network engineers.

*2 year parts and labour Guarantee on Hi-Fi and TV. 1 year on VCR's, portables, video cameras, computers and peripherals. †Ask one of our sales staff for full details. Laskys Credit Brokers, Typical Budget Account A.P.R. From 31.3% variable.



MORE ON OFFER - MORE TO OFFER

WORLDWIDE PRICE LIST

Worldwide Computers Ltd are authorised dealers for the leading computers and software at prices that are guaranteed to be the best in the country. We supply everyone from leading UK companies, government departments and local authorities to the small business and the private individual.



olivetti
APRICOT

SANYO
COMMODORE

VICTOR
EPSON

Worldwide Computers Ltd., Spa House, 11-17 Worpole Road, Wimbledon SW19 4JS. Telex: 8955888 WOWICO.
Also at: Regent House, 2 North Road, Brighton, Sussex BN1 1YA.

 **01-947 8562 & (0273) 609331**

IBM

IBM PC Model 64kb 1 x 360kb D/D	£999.00
IBM Portable 256kb 1 x 360kb D/D	£1049.00
IBM Portable 256kb 2 x 260kb D/D	£1299.00
IBM PC-XT 256kb 2 x 360kb D/D	£1549.00
IBM PC XT 256kb 1 x 360kb D/D + 10MB H/Disk	£2499.00
IBM AT Base 256kb 1 x 1.2MB Disk Drive + K/board	£2899.00

IBM ATE 512kb 1 x 1.2MB D/Drive + 20MB H/Disk + K/board	£4199.00
IBM Colour Display	£408.00
IBM Mono Display Green	£153.00
IBM EGA Colour Display	£608.00
IBM Mono Display/Printer Adapter	£149.00
Keyboard IBM Portable	£120.00
Keyboard IBM UK	£120.00

IBM/OLIVETTI ADD-ONS

Extra Memory 64kb (9 Chips)	£39.00
Hercules Colour Graphics/Printer Adapter	£181.00
Hercules Mono Graphics/Printer Adapter	£325.00
IBM Asynch Comms Adapter	£71.00
IBM Bisynch Comms Adapter V2	£165.00
IBM Colour/Graphics Adapter	£160.00
IBM EGA Graphics Adapter	£433.00
IBM EGA Memory Expan Kit 128kb	£210.00
IBM EGA Memory Expansion 64kb	£160.00
IBM PC Dos V 2.1	£49.00
IBM Printer Adapter	£71.00
Olivetti Mono Displays	£169.00
Olivetti extended Keyboard (102 keys)	£120.00
Olivetti IBM style Keyboard (83 keys)	£120.00
Olivetti Colour Display	£475.00
Keyboard 5050	£105.00
Keyboard 5151 (extended)	£175.00
Memory Expansion Card with 64kb	£140.00
Qubie Mono Display Amber or Green + Tilt Swivel	£150.00
Qubie Colour Display + Tilt/Swivel	£380.00
Sixpack Multifunction Card with 384kb	£350.00
Sixpack Multifunction Card with 64kb	£205.00
Taxan Mono Display Amber or Green	£131.00
Taxan Colour Display	£360.00
Techmar Master Graphics Adapter	£530.00
10MB 1/2 Height Hard Disc	£675.00
20MB 1/2 Height Hard Disc	£899.00
8087 Maths Co-processor	£175.00

OLIVETTI

Olivetti M24 128k 1 x 360k D/D	£875.00
Olivetti M24 128k 2 x 360k D/D	£1150.00
Olivetti M24 128k 1 x 360k D/D + 10MB H/Disk	£2250.00
Olivetti M10/24	£375.00

Olivetti M21 128k 1 x 360k D/D inc. Key + VDU	£1175.00
Olivetti M21 128k 2 x 360k D/D inc. Key + VDU	£1425.00
Olivetti M21 + 10MB iHD	£1999.00

APRICOT

PC 256K RAM + 2 x 315K D/D	£1199.00
PC 256K RAM + 2 x 720K D/D	£1349.00
Xi10 256K RAM 10MB Winchester	£2049.00
Xi10s 512K RAM 10MB + Expansion	£2475.00
Xi20 512K RAM 20MB	£2849.00
9" Monitor	£170.00
12" Monitor	£210.00

Xi20s 1MB RAM 20MB + Expansion	£3250.00
File 256 RAM 1 x 315K D/D	£525.00
Fi 256K RAM 1 x 720K D/D	£749.00
FP1 Portable	£819.00
FP2 Portable	£1149.00
Apricot compatible 12" Monitor	£170.00
Apricot colour Monitor	£349.00

VICTOR

Victor 9000 1.2	£1650.00
Victor 9000 2.4	£1899.00
Victor 9000 10	£2499.00
VPC 15MB	£2250.00

DOT MATRIX

Anadex DP 9000	£875.00
Brother M1009 (P)	£155.00
Canon PW 1080A (NLQ)	£279.00
Canon PW 1156A	£355.00
Canon PJ 1080A (Colour)	£379.00
Epson RX 80	£190.00
Epson RX 80 F/T	£215.00
Epson RX 100 F/T	£325.00
Epson FX 80	£320.00
Epson FX 100 F/T	£425.00
Epson LQ 1500	£895.00
Epson LX80	£199.00
Hewlett Packard Laser Jet	£3250.00
Mannesmann Tally MT80	£195.00
Mannesmann Tally MT180	£549.00
OKI Microline 82A	£249.00
OKI Microline 83A	£389.00
OKI Microline 84P	£629.00
OKI 192	£319.00
OKI Microline 2350P	£1449.00
Olivetti DM 5801 CB NLQ	£885.00
Panasonic KP1091	£255.00
Shinwa CP80 F/T	£189.00
Shinwa 40 (Colour)	£119.00
Smith Corona DM 200 (NLQ)	£375.00
Tec 1550	£459.00

EPSON

Epson PX8 computer	£649.00
Epson PX8 + 128K RAM	£799.00
PF10 Disk Drive	£299.00
CX 21 Accoustic Coupler	£130.00
QX16 systems from	£2100.00

SANYO

Sanyo MBC 550 1 x 160K D/D	£599.00
Sanyo MBC 555 2 x 160K D/D	£699.00
Sanyo MBC 5502 1 x 360K D/D	£799.00
Sanyo MBC 5552 2 x 360K D/D	£1149.00
Sanyo MBC 775 Portable 265 RAM x 360K D/D	£1699.00

COMMODORE

Commodore C16 Starter Pack	£39.00
Commodore Plus 4	£49.00
Commodore SX64	£575.00
Commodore PC10	£1449.00

DAISY WHEELS

Brother HR15	£315.00
Brother HR25	£555.00
Brother HR35	£695.00
Daisy Step 2000 (20 CPS)	£219.00
Diabio 630 (API)	£1310.00
Epson DX 100	£315.00
Epson P-40	£85.00
Hitachi 672 plotter	£395.00
Juki 6100	£299.00
Juki 6300	£749.00
Quen-Data	£225.00
Qume 11/40 (RO)	£1175.00
Qume letter Pro 20	£450.00
Ricoh RP 1300	£857.00
Ricoh RP 1600 8K	£1325.00
Tec 10-40	£845.00

ACCESSORIES

Keyboards, cables, interfaces, tractor feeds, sheet feeds, disks, software, up-grades, listing paper, ribbons, daisy wheels available for most products.

All prices excluding VAT and DELIVERY.

JULY.

– three hard disc models

10 MB
 +800K FLOPPY



21 MB
 +800K FLOPPY



42 MB
 +800K FLOPPY



Now U-Micro completes the U-MAN race with new 10, 21 and 42MB (formatted capacity) hard disc models using Rodime drives to add to the basic dual floppy model. RAM from 128K to 1MB (expandable to 15MB) and all the built-in features you need – 68000 CPU (10MHz) with 6809 I/O processor, clock, timers, A/D, speech and sound synthesiser, colour and mono display, graphics, programmable fonts, two serial ports, Centronics port, general

purpose parallel port, superb keyboard and four slot expansion systems. Our 'open information' policy guarantees that you'll always be able to get the most out of the U-MAN Series 1000.

The hard disc software supports both p-system and CP/M68K with disc partitioning and fast floppy back-up utilities. Remember CP/M68K languages are not limited to 64K as are the CP/M86 and MS-DOS languages. And look at the prices – 1MB RAM and 42MB

hard disc system only £6449.00. (128K RAM and 10MB disc £3789).

Dealer, OEM and export distributor enquiries welcomed.

Special deals for software developers even on the GT models.

U-Microcomputers Limited,
 Winstanley Industrial Estate,
 Long Lane, Warrington, Cheshire,
 WA2 8PR, England.
 Telephone 0925 54117
 Telex 8293279 UMICRO G

Dual 800K floppy models
 from £2499.00

Designed and made in UK.



U-MAN
 SERIES 1000 

32 bit supermicro – with hard disc

• THE NEW AMSTRAD CPC 664 WITH BUILT-IN DISC DRIVE



• THE NEW AMSTRAD CPC 664 •

• AVAILABLE AT BOOTS • COMET • CURRYS • DIXONS • GREENS • JOHN MENZIES • RUMBELOWS

THE LOW COST COMPUTER FOR HOME AND BUSINESS ·

If you know anything about computers you'll know that disc drives are up to fifty times faster than cassette when you're loading and saving programs. In fact, a disc drive makes computing faster, more reliable, more efficient and more fun. But up till now the only way to gain these advantages for a home computer was to buy a separate disc drive attachment. Now Amstrad are pleased to announce the first complete home computer with built-in disc drive: The Amstrad CPC 664.

And when you buy a CPC 664 you'll find it's not just the disc drive that's built-in.

You'll get everything you need, including a monitor (green screen or full colour). We'll even give you a free CPM and Logo disc, so all you do is plug in and you're in business.

BUSINESS OR PLEASURE ·

Although a disc drive will make games more fun (and there are loads of them to choose from) it also makes the CPC 664 a serious proposition for the business user.

There are accounting, word-processing, spread-sheet and data-base programs (to name but a few).

Amsoft Business Control, is a complete suite of programs for integrated sales invoicing, stock control and sales ledger for around £99. (Requires an additional FD-1 disc drive around £159 and DL-2 cable around £7).

business more efficient and effective by providing access to the famous range of CP/M* software.

The CPC 664 is also supplied with CP/M* to help make your

With a green screen monitor the cost is just £339. With a full colour screen it costs £449. And after you've saved money on the price of the computer itself, you go on saving on the price of software.

There are hundreds of programs for business or pleasure available on disc (and cassette) to CPC 664 users. Many from Amsoft, others from other



WITH COLOUR MONITOR AROUND

· £449 ·



WITH GREEN SCREEN AROUND

· £339 ·

famous-name software houses. Few will cost you more than £49 and most will cost you considerably less.

AN EXPANDING SYSTEM ·

There is a complete range of peripherals available to CPC 664 users which plug directly into the built-in interfaces.

These include a joystick, additional disc drive (to double your on-line storage) and the Amstrad DMP-1 dot-matrix printer. (There's also a cassette interface so that you can use CPC 464 programs on tape). And there are many more peripherals from Amstrad and other manufacturers which can be used to enhance the CPC 664.

THE HOME COMPUTER THAT MEANS BUSINESS.

HIGH PERFORMANCE

· LOW COST ·

The one thing you won't need a computer to work out is that the Amstrad CPC 664 represents outstanding value for money.

You only have to check the cost of buying all the elements separately (64K computer, disc-drive, monitor) to realise that the Amstrad package is very hard to beat.



Wordprocessing with Amsoft can improve the productivity of everyone from unskilled typist to trained secretary. Around £23.95.

· AMSTRAD USER CLUB ·

Join the optional Amstrad User Club and we'll keep you informed with our monthly user magazine, and information on all software as it is introduced. Your membership details

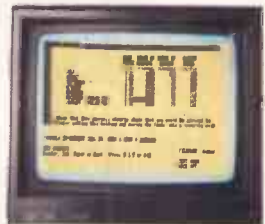

Figure analysis made easy with Microspread. An easy to use spreadsheet with pull-down menus and a wide range of mathematical options. Around £49.

will be recorded on your personal club card, which entitles members to various privileges and offers.



Please send me more information

Name _____

Address _____

Amstrad CPC 664

Amstrad, P.O. Box 462, Brentwood, Essex CM14 4EF.

PCW/664/3

*CP/M is a trademark of Digital Research Inc.

New Robo Bitstik 2 tunes in to the BBC...

At last a full Computer Aided Drafting System
for your BBC Model B Micro.



Introducing Bitstik 2, the first system to bring sophisticated CAD techniques to the desk of the BBC Model B user.

Bitstik 2 is the affordable solution to your technical drafting problems. Designed to take full advantage of your BBC's powerful graphics facility, the system is easy to learn and fast to operate.

Bitstik 2 incorporates a range of impressive functions, clearly displayed on-screen as Menus and Palettes. These are selected via the Bitstik hand controller, which also controls the dynamic 'rubber-banded' drawing cursors.

Among the system's impressive list of capabilities are:

- ▶ Auto Dimensioning
- ▶ Adjustable Curves
- ▶ Precision Grids & Angle Locks
- ▶ Powerful Zoom And Pan
- ▶ Scale Drawing & Text
- ▶ Graphic Library Index

These advanced features represent a significant step forward from the existing and very successful Bitstik Graphics System. Yet Bitstik 1 users can obtain Bitstik 2 at a Special Upgrade Price.

Bitstik 2 is produced in the UK by Robocom, the people behind the best-selling Robosystem family of CAD packages for the Apple II (+ or e) micro. To run Bitstik 2 you will need a BBC Model B with 6502 Secondary Processor, Twin Disk Drives and colour or monochrome monitor. Quality hard copy can be produced from a wide range of supported plotters.



So whether you need to produce complex architectural plans, detailed circuit diagrams or simply teach CAD on a fully implemented CAD set-up (with scope for advanced project work) you ought to be tuning into Bitstik 2 for your BBC...

Hotline Support

What's more, with Robo, advice doesn't stop when you've purchased a system. A small yearly subscription ensures that lifting your phone puts you in touch with expert help on any drawing or technical problem.

Test draw a Bitstik

See for yourself how the Bitstik 2 system can make your drafting projects easier. Just try it out, with no obligation to buy. Ask your local Robocad Centre for details of our free Test Draw a Bitstik Offer.

DIAL 100 AND ASK THE OPERATOR FOR FREEPHONE ROBO. WE'LL PUT YOU DIRECTLY IN TOUCH WITH YOUR LOCAL ROBOCAD CENTRE.

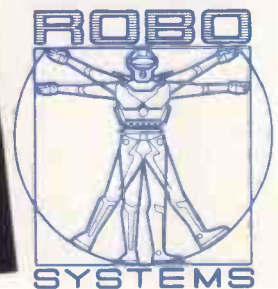

Robocom, Clifton House, Clifton Terrace, London N4 3TB.
Telephone 01-263 8585/272 8417. Telex 297137 ROBO G

SEE US AT THE ACORN USER SHOW, BARBICAN, LONDON 25-28 JULY 1985 STAND NO. 133/140.

Cash & Carry COMPUTERS

London's Largest Range of
Printers on Demonstration

DOT MATRIX PRINTERS

Brother HR5	£129.90 + VAT =	£149.38
Brother M1009	£155.90 + VAT =	£179.29
Epson P40 Thermal AC/DC	£81.90 + VAT =	£94.18
Epson RX80	£190.90 + VAT =	£219.54
Epson RX80FT+	£215.90 + VAT =	£248.29
Epson RX80/FX100/RX100	POA	
Epson LX80 NLQ (New)	£229.90 + VAT =	£264.39
Epson LQ1500 NLQ	£895.90 + VAT =	£1030.28
Epson JX80 Colour	£449.90 + VAT =	£517.39
Canon PW1080A NLQ	£289.90 + VAT =	£333.39
Canon PW1156A NLQ	£365.90 + VAT =	£420.79
Panasonic KP1091 NLQ	£255.90 + VAT =	£294.29
Dki-Mate 20 Colour	£235.90 + VAT =	£271.29
Shinwa CPA80	£199.90 + VAT =	£229.88
Anadex, Data Prods., Paper Tiger, Newbury, Dki, NEC, Tec.	POA	
Seikosha GP50S (Spectrum)	£79.90 + VAT =	£91.88
Seikosha GP500A	£113.90 + VAT =	£130.98
Smith Corona Fastext 80	£149.90 + VAT =	£172.39
Smith Corona TP1	£179.90 + VAT =	£206.89
Smith Corona D100, D200 NLQ & D300 NLQ	POA	
Star SG10 (IBM) NLQ	£225.90 + VAT =	£259.79
Kaga Taxan KP810 NLQ	£249.90 + VAT =	£287.39
Kaga Taxan KP910 NLQ	£379.90 + VAT =	£436.89
Commodore MPS801	£139.90 + VAT =	£160.89

CASH & CARRY COMPUTERS

53-59 High Street,
Croydon, Surrey CR0 1BD.

DAISYWHEEL PRINTERS

Brother HR15 (P)	£315.90 + VAT =	£363.29
Brother HR25	PDA	
Brother HR35 + sheet feed	£829.90 + VAT =	£954.39
Daisytype 2000	£219.90 + VAT =	£252.89
Diablo 630	PDA Silver Reed	PDA
Juki 6100	£319.90 + VAT =	£367.89
NEC, Ricoh, Qume, Tec.	PDA	
Epson DX100	£339.90 + VAT =	£390.89
Commodore DPS1101	£309.90 + VAT =	£356.39

MONITORS

Microvitec Colour		
1431 DS STD RES RGB	£169.90 + VAT =	£195.39
1431 DZ STD RES Spectrum	£199.90 + VAT =	£229.89
1451 DS MED RES RGB	£229.90 + VAT =	£264.39
1451 DG MED RES QL	£229.90 + VAT =	£264.39
1451 APDS MED RES		
RGB/Composite	£289.90 + VAT =	£333.39
1441 DS High RES RGB	£389.90 + VAT =	£448.39
1456 LI MED RES IBM PC	£395.90 + VAT =	£455.29
1456 DA MED RES Apricot	£349.90 + VAT =	£402.39
Philips and Ferguson	PDA	

COMPUTERS

Apricot (monitor extra)			
F1E 256K RAM 1x315K Disk	£539.90 + VAT =	£620.89	
Atari 520ST	£499.90 + VAT =	£574.89	
DISKS Prices SSDD DSDD SS96TP1 DS96TP1			
per box of ten	40TR 40TR 80TR 80TR		
BASF 5 1/4"	£10.00 £17.80 £18.50 £21.00		
3M 5 1/4"	£13.50 £19.50 £19.90 £23.90		
VERBATIM 5 1/4"	£14.50 £18.40 £18.40 £24.50		
DYSAN 5 1/4"	£15.90 £23.50 £23.50 £28.50		
TDK 5 1/4"	£17.50 £16.90* — £32.00		
SONY DS/DD 3 1/2"	£39.50 MAXELL 3"	£38.90	

Mail Order + Export + Trade
Hot Line Phone 01-686 6362



Delivery by Securicor (3 day) please add £5.00 + VAT per item.
Delivery by T.N.T. (overnight) please add £9.50 + VAT per item.

Send off the coupon or order by phone quoting your Access,
Barclaycard No. Phone 01-686 6362. Immediate
despatch on receipt of order or cheque clearance.

Or you can Telex your order on: 946240 Attn 19001335

CP/M Plus (vers 3)

For NASCOM and Gemini computers

Features:

- CP/M 2.2 file compatibility
- Banked memory system
- Fast warm boot from banked memory
- Faster disk access:—
- Directory hashing, memory caching, multi sector I/O
- Better implementation of USER levels
- Greatly extended and user friendly utility commands
- 20 transient utility commands
- Includes MAC the DRI assembler
- Multi command entry on single line
- Multiple drive searching facility
- Console redirection
- Password file protection
- Date and time file stamping
- Larger disk and file handling
- 29 additional BDOS calls
- Extended BDOS capability by easily attached RSXs
- Winchester, floppy and virtual disk
- Mixed drive/formats
- Full source code of BIOS supplied
- PLUS PLUS PLUS !!!!!!!!!!!!!

Now Only £199

Excluding post and packing and VAT

For further information contact:

MAP 80 SYSTEMS LTD.

Unit 12 Stoneylands Road, Egham, Surrey
Tel: 0784 37674

Are you

Developing Systems

Consider our modular approach
Nasbus/80 Bus compatible

CPU card

Z80 CPU incorporating memory mapping
64k RAM on board (expandable)
Z80 S10 providing two RS232 channels
CTC providing programmable baud rates
P10 providing parallel/centronics I/O
Parallel keyboard port

VIDEO card (VFC)

80 by 25 line output
Fast memory mapped display
On board floppy disk controller
Can be used with CPU card under CP/M
Available in kit or built and tested

DISK card (MPI)

Mixed 3", 3.5", 5.25", 8" drives supported
SASI Winchester interface
Z80 S10 providing two serial channels
CTC providing programmable baud rates

RAM card

64k to 256k (in 64k steps)
Supports 64/32k paging 4k mapping
Available in kit or built and tested

CLOCK card (RTC)

Attaches to any Z80 P10
Retains Centronics parallel output
Battery backup

PRICES

CPU	£230	MPI	£185
VFC	£199	RAM (64k)	£150
RTC	£35	RAM (256k)	£285

All prices exclude carriage and VAT

MAP 80 SYSTEMS LTD.

Unit 2 Stoneylands Road, Egham, Surrey
Tel: 0784 37674

· VALUE · VALUE · VALUE ·

ERICSSON



**THE IBM
COMPATIBLE**
from £1,667 + VAT

The recently launched ERICSSON PC is now available from Wolfcrown. It is exceptionally IBM compatible with extra features at a significantly lower price. On site 12 months warranty included with nationwide Ericsson backup. Standard configuration includes 128Kb, serial and parallel ports, six expansion slots, ergonomic amber monitor and splendid graphics. According to **PC USER** "At 90% of whatever the current price of the IBM PC happens to be, its an index linked bargain."

ERICSSON PORTABLE

Stunning new portable weighing 16.7lbs with full 25 by 80 gas plasma screen and full size keyboard. Options include inbuilt printer, electronic disk and integral modem.
Basic configuration from £2,580 + £387 VAT

PC SOFTWARE

Leading Edge WP £150 + £22.50 VAT
Leading Edge Nutshell DB £135 + £20.25 VAT

ALPHA MICRO

**MULTI-USER 10Mb WINCHESTER
MULTI-TASKING VCR BACKUP
UP TO SIX USERS SOFTWARE INC.**

The AM1000, the smallest machine in the range is based on the MC68000 and supports two users, expandable up to six, and is available in various configurations up to 40Mb and 1024Kb RAM memory. We are offering a 10Mb system with two word processing screens, operating system, BASIC language Assembler, word processing, over 150 utilities, and accounting software at the remarkable price of £7,250. Extra users can be added at £650 per user.

PC MULTI-USER BOARD

Why network when you can transform your PC into a multi-user Alpha system supporting up to three screens. Fit the sensational Alpha Micro 170 board into your PC and it operates as a multi-user Alpha Micro PC with access to MS-DOS. On board 128Kb memory, clock/cal, MC68000 processor and full AMOSL operating system and facilities.
£1,500 + VAT

PC HARD DISK ADD ONS

Internal 10Mb Cogito disk with Adaptec controller to run on existing PC power supply £1,250 + £187.50 VAT

External 10Mb hard disk subsystem in look-a-like case with PS, controller cable and software
£1,295 + £194.25 VAT

IBM PC BOARDS

Hercules graphics card £315 + £47.25 VAT
SIGMA multifunction card £245 + £36.75 VAT
64Kb to 384 Kb RAM, serial/parallel ports, games port, clock/calendar etc.
Ericsson colour monitor £420 + £63 VAT

PRINTERS & MONITORS

	our price	RRP
SMITH-CORONA PRINTERS		
Fastext 80.80 col/80cps dot matrix	£170	£195
D100 80 col/120cps dot matrix	£220	£249
D200 80 col/160cps, NLQ, dot matrix	£375	£420
D200 132 col/160cps, NLQ, dot matrix	£535	£595
JUKI 6100 18cps daisywheel	£340 + £51.00 VAT	
Facit and Ericsson printers		POA
eg Facit 4511-02	£505 + £75.75 VAT	
Philips 12" Green monitor	£79 + £11.85 VAT	

APPLE COMPATIBLE PRODUCTS

Slim-line disk drive	£125 + £18.75 VAT
Z80 card	£39 + £5.85 VAT
80a column card	£45 + £6.75 VAT
Printer card and cable	£45 + £6.75 VAT
Disk controller card	£35 + £5.25 VAT

TO ORDER

Please telephone order particulars to 01-629 3603 or visit our West End offices on the 2nd Floor at 58 Jermyn Street, London SW1Y 6LX.
Dealer enquiries are welcome.

2nd FLOOR, 58 JERMYN STREET, LONDON SW1Y 6LX · TELEPHONE 01-629 3603

· WOLFCROWN ·

ALSO AT PRINCE GROUP, LOMBARD HOUSE, GREAT CHARLES STREET, BIRMINGHAM · TELEPHONE 021-233 2286

EVERY CHALLENGE IN LIFE IS MADE EASIER WITH A HELPING HAND.

The new Ericsson Personal Computer comes with the best customer support services in the country.

With Ericsson you get Teach-Yourself Software; instructions in plain English; a Dial-an-Expert Service and regular

The new Ericsson Personal Computer

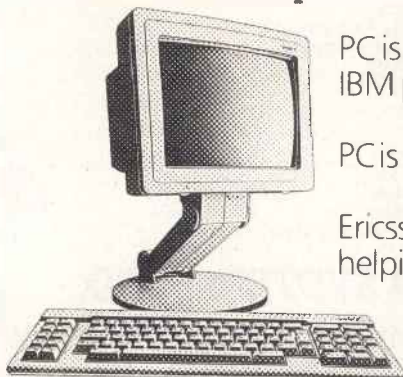

customer training courses at the Ericsson PC Training Centre. The new Ericsson

PC is IBM compatible. It runs all IBM popular software.

What's more, the Ericsson PC is smaller, neater and quieter.

But the big difference is Ericsson. Because Ericsson give a helping hand to get you started.



ERICSSON 

System Science

C Compilers

16-Bit			8-Bit
DeSmet C	£139.00	Aztec C [I]-Apple [I]	£175.00
Lattice C	£425.00	Aztec C II/BAS	£165.00
C86 & optimiser	£345.00	Aztec C II/COM	£295.00
Microsoft C ver 3.0	£475.00	C/80 Software Tool	£50.00
Aztec C86/BAS	£195.00	C/80 Mathpak	£30.00
Aztec C86/COM	£395.00	BDS C	£125.00
C80 requires LINK	£50.00	ECO-C for Z80 Code	£185.00

LISP Interpreters

LISP-80 S.Toolworks	£45.00	LISP-80 S.Toolworks	£45.00
MuLISP/MuSTAR	£275.00	MuLISP/MuSTAR	£190.00
MuMATH	£215.00	MuMATH	£235.00
IQ LISP	£195.00	micro-PROLOG	£ call

FORTH-83, Lab. Microsystems

PC-FORTH	£89.00	Z80-FORTH	£89.00
8086-FORTH	£89.00	Floating point ext.	£89.00
Floating point-sw/8087	£89.00		

ASSEMBLERS

Microsoft 8086 (MASM)	£139.00	Microsoft MACRO-80	£185.00
2500AD 8086	£89.00	2500AD Z80	£89.00
DR Assembler Plus	£185.00	DR Assembler Plus	£185.00
Cross-Assemblers	£ call	Cross-Assemblers	£ call

Editors

Final Word-IBM, MS-DOS	£275.00	Final Word-CP/M	£275.00
SEE IBM, Apr	£50.00	PMATE IBM, Apr.	£195.00
Vedit Plus-IBM, MS-DOS	£215.00	ED-editor IBM	£65.00
FirstTime C (syn. check)	£275.00	FirstTime Pascal	£245.00

Tools — many C tools available		Dbase to C conv.	£995.00
Crosstalk comms-IBM, Apr.	£125.00	Uniform- disc conv.	£69.00
Pascal Compilers	£ call	Fortran Compilers	£ call
VENIX-86 full Unix for IBM PC-XT and PC-AT from			£850.00



HSC 16 bit Co-Processors for Z80 CP/M systems

- choice of 8086 or 68000
- MS-DOS, CP/M-86 and CP/M-68K
- use as RAM DISK under CP/M
- simple to install, simple to use
- 6 MHz clock
- 256Kb to 1.25 Mb memory
- fit most Z80 systems
- Prices from £625.00

Prices are exclusive of VAT and postage

6-7 West Smithfield, London EC1A 9JX
Tel: 01-248 0962





Training Programming Software

55 Peascod Street
Windsor, Berks
Tel: Windsor
58182/58013

HISOFT

High Quality
Microcomputer
Software

CP/M PASCAL

When choosing a compiler, support is crucially important. It is vital to ensure that you will receive technical back-up for the package as quickly as possible. This may prove difficult, if not impossible, when the software was designed in another country and you have no access to the authors. **HiSoft Pascal** is a British product, created and manufactured by ourselves and fully supported by our technical team here in Dunstable. We offer inexpensive upgrades and we are continually extending and improving the compiler.

HiSoft Pascal is available in a wide variety of Z80 CP/M disc formats, is very close to Standard Pascal and comes supplied with a comprehensive and sophisticated full screen editor (ED80) which is specially designed for program development; the editor may be easily configured to suit all displays and also for special keyboards and individual keystroke sequences.

All this for a fully inclusive price of **£39.95!**

High Quality Software at a Fair Price.

HiSoft was founded over four years ago and since then has built up a reputation for the quality of its products and the strength of its support. Our utility and language software is available for most of the home computers currently on the market and we are always developing new products: our latest is **Devpac 80**, a powerful assembly language development package for all Z80 CP/M computers. **Devpac 80** is a macro assembler (GEN80), a configurable full screen editor (ED80) and a super front panel debugger (MON80) all in one integrated package.

Devpac 80 makes Z80 assembly language development a joy to do and is incredible value at only **£39.95 inclusive!**

Please feel free to write to us or telephone for immediate despatch of full technical details of all our products — there is so much more than we can say in this small space. Our next product for CP/M-80? Wait and C!

HISOFT

180 High St. North
Dunstable, Beds
LU6 1AT
Tel. (0582) 696421

SOUTHEND'S PRINTER Specialist

SEIKOSHA GP500A	£149.00
BROTHER HR5 (also for CBM64)	£149.00
SMITH CORONA FASTEXT 80	£169.00
BROTHER M1009	£199.00
SHINWA CP80	£199.00
SHINWA CP80	£209.00
MANNESMAN TALLY MT80 PLUS	£219.00
MP165 WITH LQ	£299.00
SAKATA 1200 PLUS WITH LQ	£310.00

DAISY JUNIOR (DAISYWHEEL) £249.00
PLOTTERS IN STOCK FROM £ 89.00

OTHER PRINTERS AVAILABLE

RIBBONS FOR MOST POPULAR PRINTERS

ACCESS/VISA TELEPHONE ORDERS WELCOME
PLEASE ADD £10.00 FOR COURIER DELIVERY

Minnie Micro

12 EASTERN ESPLANADE · SOUTHEND
(0702) 615809

MAIL
ORDER ONLY

The BEST DIRECT PRICES

cerac disks

Cerac Computer Supplies Limited

3M Authorised Distributor
Data Recording Products

5¼" DISKETTES	CODE	BOXES		
		1-9	10-49	50+
DOUBLE DENS/S.S	744	£14.40	£13.40	£12.40
DOUBLE DENS/D.S	745	£19.60	£18.20	£16.90
QUAD DENS/S.S	746	£22.00	£20.50	£19.00
QUAD DENS/D.S	747	£25.50	£23.80	£22.00

5¼" TDK SPECIALIST DISTRIBUTOR

DOUBLE DENS/S.S	M1D-S	£14.50	£13.50	£12.50
DOUBLE DENS/D.S	M2D-S	£20.60	£19.20	£17.80
QUAD DENS/S.S	M1DX-S	£21.20	£19.70	£18.30
QUAD DENS/S.S	M2DX-S	£25.10	£23.40	£21.60
* HIGH DENS		£51.00	£47.50	£44.00

* For Olivetti M30 and IBM PCAT				
3½" DBLE. DENS/S.S MF1DD		£36.30	£33.80	£31.30

5¼" NASHUA COPYCAT		LIBRARY CASES 5¼" Capacity 10	
DOUBLE DENS/S.S	MD1D C/B	£13.40	£12.50
DOUBLE DENS/D.S	MD2D C/B	£15.90	£14.80

3½" RHONE POULENC		Capacity 50	
DOUBLE DENS/S.S		£42.10	£39.20
DOUBLE DENS/D.S		£54.50	£50.80

POST and PACKING PER 10 DISKS 75p FOC FOC

01-773 0641

ACCESS/BARCLAYCARD welcome!

Allow 7 days ANSWERING SERVICE AFTER 5.30PM
for delivery 44 Wallington Square, Wallington, Surrey

ADD
15% VAT
TO ALL
ORDERS
please!

LONDON COMPUTER CENTRE



IBM PC, XT, AT



IBM PC, upgraded with 20 MB
HARD DISK, 512 K RAM, CLOCK
CALENDAR, SERIAL PARALLEL,
MONO DISPLAY KEYBOARD
OPTION AS ABOVE COLOUR
25 MB EXTERNAL BACK-UP

£2950

£3250

£ 895

NorthStar™

DIMENSION

The IBM compatible

Multi-user

system (up to 12 users)

15Mb hard disk and 2 user stations

complete with VDU running IBM graphics

Each subsequent work station

£6,300

(8088 CPU 128K RAM)

£1,450

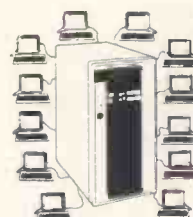

apricot FULL RANGE

FI, X1-10, X1-10 S, X1-20

PRICES CALL

POINT 7 POINT 32

SANYO

550: 2 x 160 K DRIVES + MONITOR

£ 795

550: 2 x 800 K DRIVES + MONITOR

£1095

FERRANTI: IBM COMPATIBLE

2 x 360 K DRIVES

£1249

256 K RAM, MONO MONITOR

PLOTTERS

MONITORS

HP 7470A 2 PEN

£1125

KAGA 12" HI-RES RGB IBM

HP 7475 6 PEN

£2085

IBM-PC

£399

ROLAND DXY 880 8 PEN,

£820

ROLAND DG 14" COLOUR

£375

HP COMPAT

£820

KAGA 12" MONO IBM

£129

EPSON H1-80 4 PEN A4

£400

HARD DISKS & STREAMERS

MODFMS

IBM, APRICOT, OLIVETTI, SANYO

BUZZBOX

£ 69

External:-

MINOR MIRACLE

£130

10 MB

£1295

30 MB

£2145

THORN VX 433

20 MB

£1545

40 MB

£2395

AUTO DIAL/ANSWER

£180

Streamer 25 MB

£895

LAP PORTABLE

20 MB + 20 Streamer

£2950

Internal:-

10/20 MB

£995/£1295

NEC 8201 16 K

£299

10 MB Streamer

£850

EPSON RX-8

£795

PRINTERS: PHONE FOR PRICES

CANON PW 1080	160 CPS	JUKI 6100	18 CPS
CANON PW 1056	160 CPS	JUKI 6300	40 CPS
EPSON FX 80/100	160 CPS	TEC - 1500	25 CPS
EPSON RX 80/100	100 CPS	TEC - F 10	40 CPS
EPSON LQ 1500	24 PN	NEC - 2050	20 CPS
BROTHER 1024	24 PN	OUME 11-40/85	40/55 CPS
TOSHIBA 2100	24 PN	DIABLO 630	40 CPS
FUJITSU DLP 24	24 PN	FLOWRITER 1600	60 CPS

SOFTWARE:- WIDE RANGE OF
CPM, PC DOS, MS DOS
CALL FOR PRICES

43 Grafton Way, London W1P 5LA (Opposite Maples)

Opening Hours: 10-7 Mon-Fri. 10.30-4 Sat.

01-387 4455 (4 lines) Telephone Answering Service After Office Hours

Telex: 8953742

DEMONSTRATIONS
SALES SERVICE
SUPPORT

We have more of what it takes.

So what's Tandy got the others haven't? Quite simply we've got more. A range of computers that's second to none.

If you're in business then our Tandy 4/4P, 1000, 2000 and 6000 range of computers can handle your company's needs.

And for those who need a portable computer we offer you the Tandy 100 and the new Tandy 200 to give you true computing power wherever you go.

Not only have we got more—you get more from us. More for your money—not bills for add

on "extras" that a computer should have in the first place.

We've got it all—nationwide.

If figures impress you then Tandy's 300 stores and dealers nationwide, including 50 stores with computer departments, will be of interest. All geared to provide you with the total support you would expect from the third largest micro-computer manufacturer in the world.

Test out Tandy. We've got more of what it takes—have you?



TANDY[®]
COMPUTERS

The range that's clearly superior

Available from selected Tandy Stores, Dealers and AT Computerworld. Dealer enquiries welcome.

Tandy Corporation (Branch UK), Bridge Street Walsall, West Midlands WS1 1LA. Telephone: 0922 648181.



Top row KX1203, K12SV3, KX1201. Bottom row K12R3, K12R2. Optional 'tilt and swivel' stand shown with certain models.

Aim straight for a Taxan

When you're aiming for the best monitor around, set your sights on a Taxan.

Because Taxan are quite simply the biggest selling range of monochrome and colour monitors in Britain today.

And that's hardly surprising since every Taxan Monitor is designed and engineered for superb style and maximum performance.

Take a look at the KX1201 and KX1202 for example.

High quality, high resolution 12 inch monitors offering a choice of Green or Amber display with a long persistence option on the Green phosphor model.

With the latest non-glare flat tube for easier viewing and more than 20MHz video bandwidth, you can't do better than a Taxan monochrome monitor.

Taxan also produce a range of 12 inch RGB colour monitors that give you unbeatable price performance.

Like the medium resolution K12R2 (Vision II) and the high resolution K12R3 (Vision III).

Compact professional monitors, suitable for all popular micros. Built-in switchable RGB interface for

added versatility and both suitable for 80-column text display.

Finally, the K12SV3 (Super Vision III). A 12 inch, RGB, super-high resolution, colour monitor with three different monochrome modes. Fully compatible with IBM PC, Apple, BBC and most other personal computers it is simply the most versatile monitor on the market today.

Taxan Monitors retail at around:

KX1201G	£109 (plus VAT)
KX1202G (P39 Phosphor)	£119 (plus VAT)
KX1203A	£119 (plus VAT)
K12R2	£285 (plus VAT)
K12R3	£399 (plus VAT)
K12SV3	£429 (plus VAT)

Ring us on Ascot (0990) 28921 for the name of your nearest dealer. And find out why you should aim straight for the best-selling range of monitors around.



5 King's Ride Park,
Ascot, Berks. SL5 8BP
Tel: 0990 28921
Telex: 846303 DD LTD G.

THE NEW FORCE IN DISTRIBUTION

Lotus Jazz. Now the Mac's really in business.

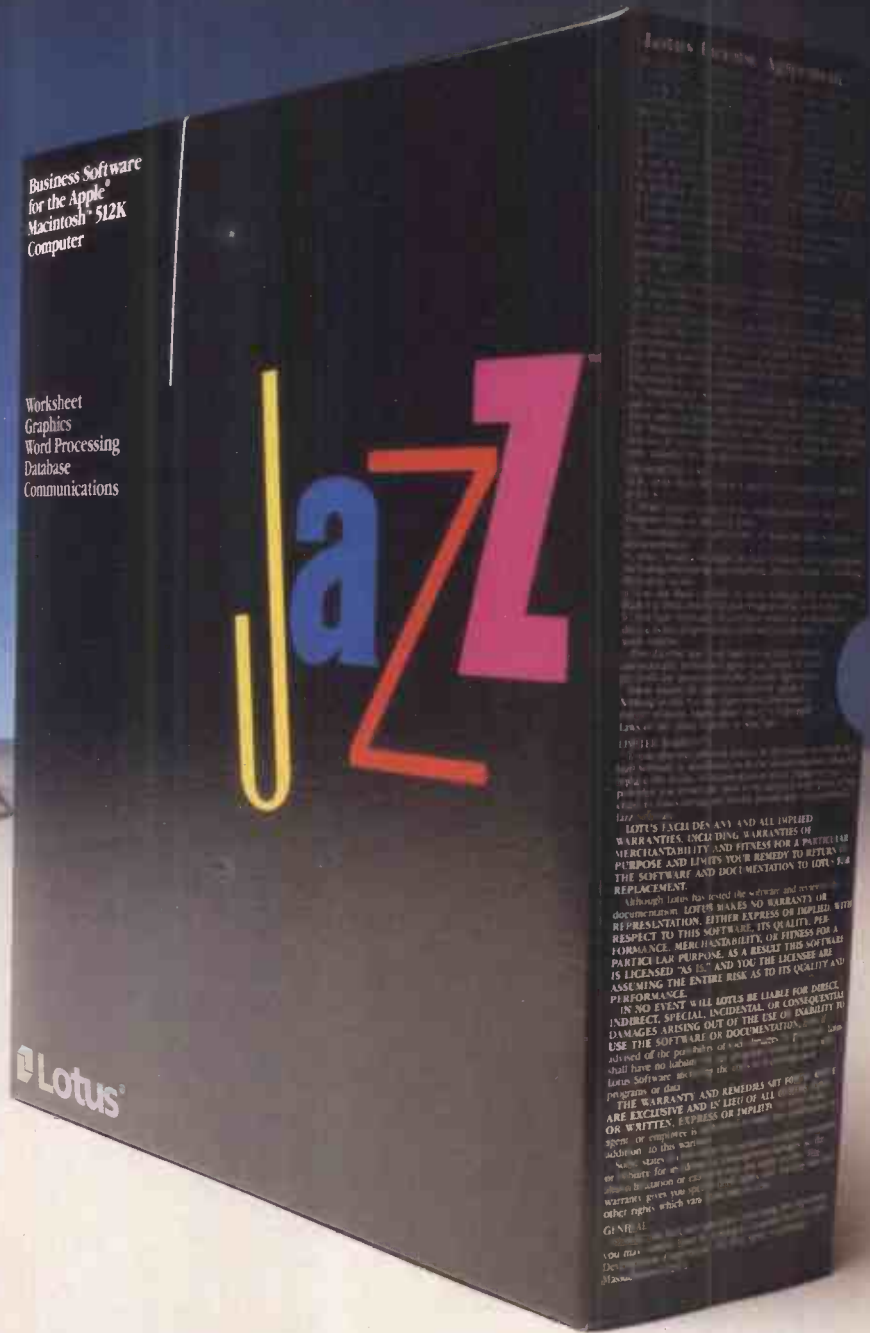

Jazz is a stunning new 5-in-1 package, created by Lotus especially for the Macintosh.

Just imagine. All the power of Lotus software, with the accessibility of the Mac.

Adding up to one thing. Unbeatable computing power for every business.

Call First Software today for your nearest Lotus Jazz dealer.

FIRST SOFTWARE

DISTRIBUTOR OF THE WORLD'S LEADING SOFTWARE

First Software, Intec-1, Wade Road, Basingstoke, Hants, RG24 0NE. Tel: 0256 463344. Telex: 859030 FIRSTG

Lotus, Jazz are trademarks of Lotus Development Corporation. Macintosh is a trademark licensed to Apple Computer Inc.

"No Call Apple ... no comment!"



Now in its eighth year of publication, Call A.P.P.L.E. is the leading US journal to the worlds largest Apple user group. Now every Apple user in the UK can benefit from this invaluable magazine, direct and only from Boot Out. We also have special bound collector editions of Call A.P.P.L.E. 82, and 83. Available now at the low Boot Out price of only £16 per copy. All about Applewriter IIe has just arrived from the US, a welcome addition to the already popular All about DOS, Applesoft and Pascal books and diskettes. Remember, we also stock exclusive call Apple software. Send now for a complete list of over 100 titles.



The exclusive call apple distributor.

SEE US AT STAND 3058 AT THE PERSONAL COMPUTER WORLD SHOW

TO: Boot Out, PO Box 147, Putney, London SW15 1AU. 01-788 1454

- Please start my subscription for Call A.P.P.L.E. on _____ Month Year
- 12 issues £31.50 inc p&p
- 24 issues £63.00 inc p&p
- Overseas
- 12 issues £39.50 inc p&p
- 24 issues £79.00 inc p&p
- Please send me collector
- 1982 1983 editions - £16.95 inc p&p
- Please send me a free software price list
- I enclose cheque/postal order made payable to.



Boot Out for £ _____

Please debit my Access/Barclaycard (delete as applicable) Numbers

Exp Date _____

Name _____

Address _____

Tel No _____ PCW 8/85

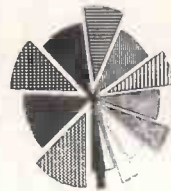

dGE

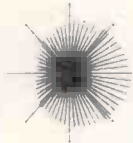

HI-RES GRAPHICS ON-SCREEN
DIRECT from **dBASE** (II & III) programs

The data base Graphics Extension (dGE) adds 28 new functions to dBASE, allowing you for the first time to generate hi-res graphs and charts on-screen directly from dBASE programs.

PRICE: dGE-2 for dBASE II **£90 + VAT**
dGE-3 for dBASE III **£120 + VAT**

Versions: SIRIUS/VICTOR, APRICOT, IBM + Col/Graphics or Hercules

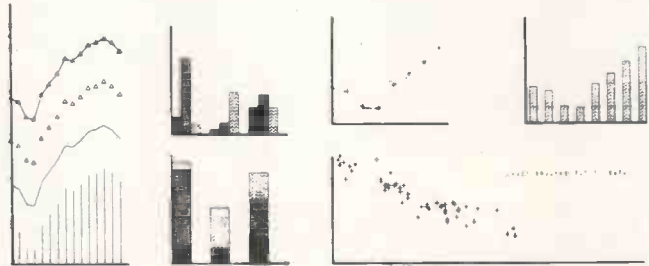

Bits Per Second Ltd.
9 Sudeley Terrace, Brighton BN2 1HD
Telephone: (0273) 699720

HISOFT

High Quality Microcomputer Software

Product Price Table

Machine Product	Spectrum	Amstrad	MSX	CP/M	QL
Pascal	25.00	29.95	29.95	39.95	
Devpac	14.00	21.95	19.95	39.95	19.95
C	25.00	34.95		*	(MON QL)
Ultrakit	9.45				
Font64		7.95	(Font designer/screen dump)		
The Knife		12.95	(CP/M disc editor)		
The Torch		12.95	(CP/M disc Tutorial)		

All prices in £ sterling. *Coming soon!

Here's what other people say about HiSoft Software:

Our Customers:

- C** "more addictive than any arcade game"
R. Walker
- Devpac80** "a brilliant piece of software" *A. Brown*
- Ultrakit** "a great acquisition" *J. Le Page*

The Press:

- Pascal** "if you wish to teach yourself Pascal ... you won't go far wrong to buy HiSoft's Pascal" *PCF 1/84*
- Devpac** "it is impossible to recommend any other development package for the Spectrum" *ECM 4/84*
- C** "the most welcome addition to the Spectrum catalogue since Sinclair introduced the Microdrives" *Sinc. User 12/84*
- Font64** "the manual is clear ... very simple to use" *PCT 7/85*

These are only a few of the glowing comments that we have on file showing that user and critic alike find HiSoft software offers a refreshing change of style.

We produce and market a wide range of high quality, professional and well-documented software packages for the popular home micros. Our type of software is becoming increasingly more popular as people get tired of zapping aliens and want to put their brains to work; learning new computer languages (Pascal, C, Devpac), investigating their computer's power (The Knife, The Torch) or being artistic (Font64), we have it all. Please feel free to write to us or phone for full technical details of any of our products. The above prices are fully inclusive and you can order directly from us or through your local computer shop.

Programmer's: we are currently seeking to engage an experienced programmer to join our team in Dunstable. Please contact Sue on (0582) 696421 for further details.

HISOFT

180 High Street North,
Dunstable, Beds. LU6 1AT
Telephone (0582) 696421

PCW SHOW FOCUS

The 8th Personal Computer World Show

The 1985 PCW Show at Olympia, London, is the industry's annual showcase. Here's the second look at what's on show for personal computer users in business, industry and education, and for the home computer enthusiast.

The winning combination

The combination of changing technology and increased competition is making more computer power available to more users than ever before, and the PCW Show is the place to find out just what that means: wider choice, improved performance and better value.

There's something for everyone at Olympia in September: for business and professional users, for teachers, for families — and of course for every personal computer enthusiast. Alongside the big names, you can also find many smaller, specialist firms and an unrivalled range of features designed to inform, to educate and to entertain.

For the first time since moving to its new Olympia home, the show occupies two halls. Olympia 2, scene of last year's event, will this year cater for business and professional users only. That's where to find the ATs and XTs, Apples and Apricots, plus the special PCW Show help and advice services for business users, particularly first-time users.

Next door in the National hall is where the "battle of the giants" takes place, with Atari, Commodore and Amstrad lined up right inside the front door — all offering powerful machines for the enthusiast and small-business user. This hall is also the setting for Britain's biggest selection of games software, and features such as the "living room of the future" sponsored by a big name in MSX computing, Toshiba.

For business and professional visitors, complimentary tickets are available. These include the facility for advance registration, by-passing the cash desks and registration counters at the entrance to the show.

Admission for all other visitors is £2.00 (with a

discount for groups). These can be bought in advance using the coupon inside this PCW Show Focus feature.

Tour the new technologies

An easy-to-understand presentation dealing with the impact of new computing and communications technologies in the corporate environment will be one of the highlights of Olympia 2, the business and professional hall.

Covering such developments as networks, mini and mainframe links, electronic mail and corporate information systems, the area will include displays, videos and small-group seminars. It is intended for professionals in partnerships and firms, managers and their staff in company departments — in fact anyone who works as part of a group.

This Corporate Computing Centre will be organised to give visitors a "conducted tour" of the new technologies and their impact, catering for different levels of understanding.

CAD system at low cost

KGB Micros, which attracted a lot of attention at last year's PCW Show with the Torus Icon network software, expects a similar impact this year with Autocad, the micro-based design system.

Originally developed as a low-cost CAD system for engineers, Autocad is now finding friends in an increasingly wide range of businesses, says KGB's Sandy Saunderson. Recent customers have included interior designers, airconditioning installers, electronics firms using the system to produce pcb schematics and even stockbrokers using it to draw

flowcharts.

Success with Autocad, he says, is attributable to two factors: the capability of the product itself, which has become almost an

international standard for micro-based drawing systems, and KGB's own investment in specialist staff, who will be on hand at the show to demonstrate the system and



Atari chief Jack Tramiel will personally spearhead the launch of the much-heralded 520ST on the opening day of the Show. The outspoken Tramiel says the "power without the price" of the new machine will mean another revolution in computing. For anyone unfamiliar with his style, this is how he introduced the 520ST in the US: "We're in the business of People's Technology. And as Henry Ford said, for every dime you remove from the cost, a whole new stratum of buyers is revealed. I believe it, and that's how this business is going to be from now on."

Atari has been working with many leading software houses for several months, and expects to have about 100 software packages demonstrated on its stand in Olympia's National hall — the majority being for business and education users. The mouse-driven GEM graphics environment comes as standard on the 520ST, making the operating system "easier to use than explain" and Atari says that a full range of software and peripherals will be available when the machine goes on sale.

The 520ST debut marks a new round in the fight for the small business machines market, with Amstrad and Commodore among the other contenders at the Show. All three will be found on the ground floor of the National hall.

PCW SHOW FOCUS

answer visitors' queries.

The latest version of the system has a 3D capability, and also on demonstration at the show will be CADCamera, which can scan drawings in minutes to store the information on the computer for incorporation in future designs. This appeals to users such as building services engineers who have to plan new installations within existing buildings, for which drawings are already on file.

Helping hands for buyers

This year for the first time, the PCW Show provides some special features designed to help buyers in choosing the hardware, software and systems for their particular business. It's often difficult to discover what software is available for specific applications, so at PCW Show we are providing two key sources of advice and information.

The most extensive of these is the consultancy area, which brings together a number of specialist consultants and the Applications Software Advisory Service, sponsored by Micro Decision magazine. This is a database system which lists every available piece of business software for personal computers, identifying the application, supplier, operating system and other details — whether or not it is being demonstrated at the show.

On the ground level there is the NCC Microsystems Centre stand on which will be running the NCC Directories on Disc, providing up-to-date information on more than 5 000 business software packages.

Next door in the PCW Show lecture theatre, a team from the Microsystems Centre will be running daily seminars on how to choose your system. These sessions cover the main issues involved, starting with the question why use a micro at all? The NCC view is that one business in four needs a computer "like a hole in the head" while for the other three the key to a successful, effective system, is one part discipline, one part training and operation, and one part dealer support.

The seminars will be given at 10.30 and 2.30 on Wednesday, Thursday and Friday,

September 4, 5 and 6, and at 2.30 only on Saturday September 7. The fee at the door will be £25 + VAT, but for those booking in advance there will be a 50% discount, making the fee £12.50 plus VAT.

New Philips range debut

In a renewed assault on the UK market, Philips, the European electronics giant, is launching its latest range of machines at the PCW Show, with first deliveries to end-users following a few days later. First shipments have been placed with leading software houses since the end of June to ensure early implementation of a wide range of business packages, and Kingsway Data Services, the UK distributor, says the launch has been planned to ensure adequate stocks from the start.

There are three machines in the range, all priced and packaged very competitively. The entry-level machine, selling for about £1000 has 128k memory and one 720k 3½ in. disk drive — a configuration which will appeal to first-time business users and the education world. Next up the scale comes the £1500 twin-disk machine, and at the top of the range comes a 10Mb hard-disk model. The main operating system is DOS Plus, which resides in ROM so that the main memory, which is expandable to 640k, is almost entirely available to the user.

In addition to DOS Plus, MS-DOS and Concurrent DOS are also available, and GEM will be available shortly. Language versions offered are GW Basic and DR Logo. The twin-disk machine comes complete with

Open Access. This is an integrated business system which includes a powerful database, graphics, WYSIWYG wordprocessing, and a spreadsheet which features 'goal-seeking' — you provide the desired solution and the computer calculates the starting figures.

The machine has a comparatively small footprint, (42 × 36cm for the main system box, into which the keyboard clips when not in use) and weighs in at 5.5kg, putting it comfortably in the luggable class. A further aid to using the machine out of the office is the ability to substitute a domestic colour TV for the monitor, using a simple adaptor.

Kingsway has been closely involved in the development programme over the past two and a half years. Peter Crawley, the firm's technical chief, has

recently returned from Philips in Vienna, where he was involved in implementation of operating systems, and the company offers a 24-hour delivery service from its base in Chertsey, Surrey, to the UK dealer network.

Stella Tempest, a Kingsway director, says that the September launch is being carefully planned to ensure that there will be no shortage of products in the weeks and months following the Show — and that means applications software as well as the Philips hardware. A number of systems for vertical markets are being developed in conjunction with software houses, and among those which are expected to be demonstrated at the Show are systems for newsagents, hotels, the building industry and golf clubs.



BOOK NOW FOR NCC SEMINARS

Please reserve _____ places at the following seminar session(s) at a reduced cost of £14.38 per session. Indicate your first and second choice by marking 1 and 2 in the appropriate boxes:

To: PCW Business Seminars
NCC Microsystems Centre
New Fetter Lane
London EC4

Wednesday 4 September	10.30 <input type="checkbox"/>	2.30 <input type="checkbox"/>	Friday 6 September	10.30 <input type="checkbox"/>	2.30 <input type="checkbox"/>
Thursday 5 September	10.30 <input type="checkbox"/>	2.30 <input type="checkbox"/>	Saturday 7 September		2.30 <input type="checkbox"/>

Name _____ Company _____

Address _____

Postcode _____ Tel. No. _____

Nature of business _____

Please enclose a cheque for the full amount, made payable to: NCC Microsystems Centre.

PCW SHOW FOCUS

Award for school projects

London Plus, BBC Television's London and South East news programme, is sponsoring a new award for schools which will be presented at the PCW Show. The awards will go to the school team or individual using a micro to the best advantage in the study of another specific subject — not computers.

The variety of schools computing projects grows daily, ranging from a fish farm controlled by a micro to a Logo turtle used to draw dress patterns for needlework students, and it is applications such as these which are now being sought by London Plus.

The 1985 projects, which will be submitted for The London Plus Schools Micro Awards will be judged by a team of specialists who will be looking for the imaginative use of the new technology to obtain practical and interesting results.

First prize is £1000-worth of equipment, hardware or software, followed by £750 and £500-worth for the second and third placings, all to be selected at the Show.

Also of interest to teachers

is a help and advice area, the PCW Show Computers in Education feature. Located in the main National hall, this will be manned by teachers or former teachers with first-hand experience of using computers in primary and secondary schools, and in higher education. They will be able to answer questions, help in solving problems, and demonstrate some of the projects undertaken with their pupils and students.

The stand is sponsored by Computers in Education Journal, the specialist publication, which operates a comprehensive database listing thousands of educational hardware and software products, all listed and cross-indexed by age, subject and other parameters including operating system. The system will be operating on the stand so that teachers and others involved in the education world, such as advisers, trainers and local authority support staff, will be able to identify the products which meet their needs.

Complimentary tickets for individual teachers are available in advance from the show organisers and these are valid for any day of the show. Admission at the door is £2.00; groups of 10 or more (including school parties) can

Record entries for efficiency and innovation Awards

More than 40 firms have already entered the 1985 Standard Micro Business Awards. Sponsored by The London Standard newspaper, the awards are given for innovations in hardware and software which offer "outstanding contributions to business efficiency and profit".

Anthony Hilton, City Editor of The London Standard and chairman of the judging panel, said: "At a time of so much uncertainty in the computer market, the importance of thorough marketing and product development is greater than ever before. The Awards are intended to give recognition to worthwhile efforts in these directions".

The entrants include both major names in the industry and several smaller, specialist software houses. They are being judged by a panel drawn both from the computer industry and the world of business and finance. In addition to Anthony Hilton, other members include Eric Bagshaw of the NCC Microsystems Centre, David Tebbutt, software author and consultant, Graham Cunningham, editor of PCW, together with Michael Jones, finance director of The Standard's publishing company. Presentation of the Awards takes place at Olympia on 4 September, the opening day of the Show.

Among those companies taking part are: Amstrad, Apple, ABS Oldacres, Aston Technology, Enterprise, Kempston, KGB, MicroPro, Olivetti, Philips, Sanyo and Systime.

obtain a discount of 50p per head by booking in advance but this is only available for Friday-Sunday, 6-8 September.

Walk right in

Complimentary tickets with advance registration are now

available for business, professional and trade visitors to PCW Show.

Apply now, and you can receive a VIP visitor pass, so that you can walk straight in at the entrance to Olympia, avoiding the cash desks and eliminating delays.

Both complimentary tickets and visitor passes are valid every day of the show — but business and trade buyers may prefer to attend on Wednesday 4 and Thursday 5 September, when the general public will not be admitted.

Designation of these two Trade & Business Days is a response to the demand both from visitors and exhibitors, who value the extra space and time.

To obtain your complimentary ticket and registration for VIP visitor pass, write on business letterhead to: PCW Show Advance Registration, 11 Manchester Square, London W1M 5AB.

Moving into business

Cumana, which made its name supplying add-ons for educational and home-user machines, is now moving into the business market with a number of new products.

These include an upgrade board for the BBC which will offer 512k RAM, a full implementation of the OS9

BOOK IN ADVANCE FOR THE No.1 SHOW

To obtain tickets (£2.00 each) in advance complete this form and return to PCW Show 85 Ticket Office, 11 Manchester Square, London W1M 5AB

I enclose cheque/postal order
Please debit my Access/Barclaycard card number

for the amount of £ _____
(Cheques made payable to Montbuild Ltd.)

Name	Mr/Mrs/Miss
Address	
Post Code	

Business and Trade Days 4-5 September 1985

Only bona fide business, professional, education and trade visitors over the age of 18 will be admitted on Wednesday and Thursday 4 and 5 September.

PCW SHOW FOCUS

operating system, plus multi-user and multi-tasking operation. A powerful graphics kernel is also included, and the package also comes complete with a spreadsheet and word processing.

Clive Martin, the company's marketing manager, says the new board gives Cumana "the ability to bring high-quality performance to the High Street at a price well below the usual cost of business machines." In addition to the 512k memory, the board also offers a 68008 processor, controller for up to four floppy disk drives and a SASI interface for one or two hard-disk systems.

The state of the industry

Leading figures from the world of personal computing will discuss the state of the industry at a special Keynote Conference on the opening day of the PCW Show.

Those taking part include Paul Bailey, vice-president of Digital Research, Nick Bessey, head of Commodore UK, and either Roger Foster or Brian Androlia of ACT. In the chair will be David Tebbutt, industry

consultant and former editor of PCW.

The event is organised by MicroScope, the weekly newspaper of the industry, which is also arranging three half-day trade conferences. Under the chairmanship of Russ Nathan, managing director of Romtec, these will cover the selling of business hardware and software, selling to home computer enthusiasts, and selling peripherals.

On the air

PCW Show will be on the air this year, with a special edition of Thames TV's Database programme. The Database crew will film at Olympia on the opening day, and the programme, which attracts an audience of more than one million viewers, will be transmitted the following day, Thursday 5 September, in the London area. The following week it will be repeated nationally on Channel 4. Producer Michael Feldman says he cannot yet say what the programme will cover, but it is expected to concentrate on innovations such as GEM.

Special for Business

Business and professional visitors will all receive a free copy of the latest PCW Special — Profit through Business Computing — price £2.25, which will be published at the Show. This latest publication builds on the success of the Business Computing Survival Guide which was published earlier this year, and will be valuable both to experienced users and those buying their first system.

In-depth coverage includes first-hand accounts of several very different users' experiences in using business micro systems, including a small financial institution, a firm of project managers and consulting engineers and a market research organisation. The case studies will examine what each firm did — and why — the selection of hardware and software, the problems encountered, and an assessment of how successful each system has been.

"Icons, windows and mice — a gimmick or the way ahead?" will examine the new approach to operating environments and take a critical look at these techniques.

The PC's role in corporate computing will be examined in a "future history" feature, which will look back from the viewpoint of the early 1990s. Back in today's world, there will also be special articles on gateways and information services — electronic mail systems and major databases such as World Reporter. How good are they? How easy to use — and are they value for money? Expert systems will be subject to a similar examination.

"Getting the best out of the best sellers" will help many experienced users to make the most of popular packages such as 1-2-3, Dbase II and Wordstar: helping you to make the big leap from using them to exploiting their full potential.

Also included in this complimentary publication will be a look at support services, such as training and maintenance, some advice on security, and a view of the future from four major manufacturers.

Where to find the Show

The PCW Show takes place at Olympia, in West London. The exhibition centre has its own Underground station so it can be easily reached from all parts of the capital. Travel to Earls Court on the District or Piccadilly Lines and look out for the special PCW trains running from there throughout the show. For visitors travelling by car, Olympia is readily accessible from the M1, M4, M40 and North Circular Road. There is ample parking for cars and coaches within a few minutes walk of the exhibition halls.

Those spending more time at the show — whether visitors or exhibitors — can take advantage of special discounts arranged at hotels in all price categories from budget to 5-star. For details phone the Expotel hot-line on 01-741 4411.

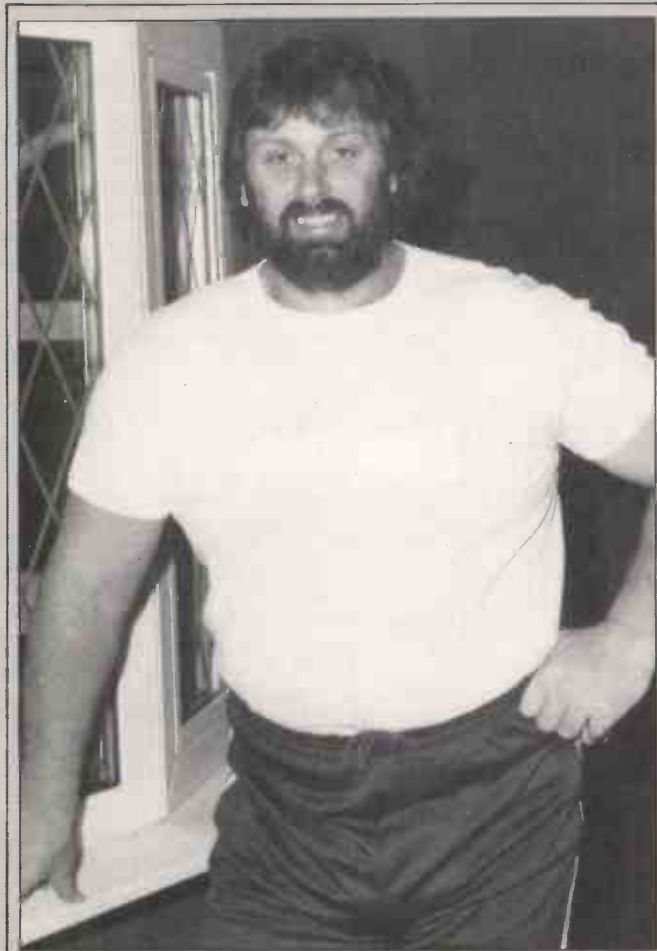

Anyone who fancies his chances against 23-stone strongman Geoff Capes in the Highland Games need look no further than Software Communications' stand on the gallery of the National hall.

Geoff Capes Strongman Challenge is the latest game to be introduced by the South Coast software house and the Olympic athlete himself will be launching it on the opening day of the show — shortly before leaving to compete in the Highland Games at Braemar.

Also making its debut at the show will be an educational program about Halley's Comet. This is linked with a new Channel 4 series called The Planets which will be presented by Heather Couper, President of the British Astronomy Association. She is acting as a consultant to Software Communications for the development of the Halley's Comet program and it is hoped she will also be able to put in an appearance at the Show.

The 8th
**Personal
Computer
World
Show**

4-8 SEPTEMBER 1985
OLYMPIA, LONDON

Sponsored by Personal Computer World

The New MT 85/86 printers are as quiet as a...

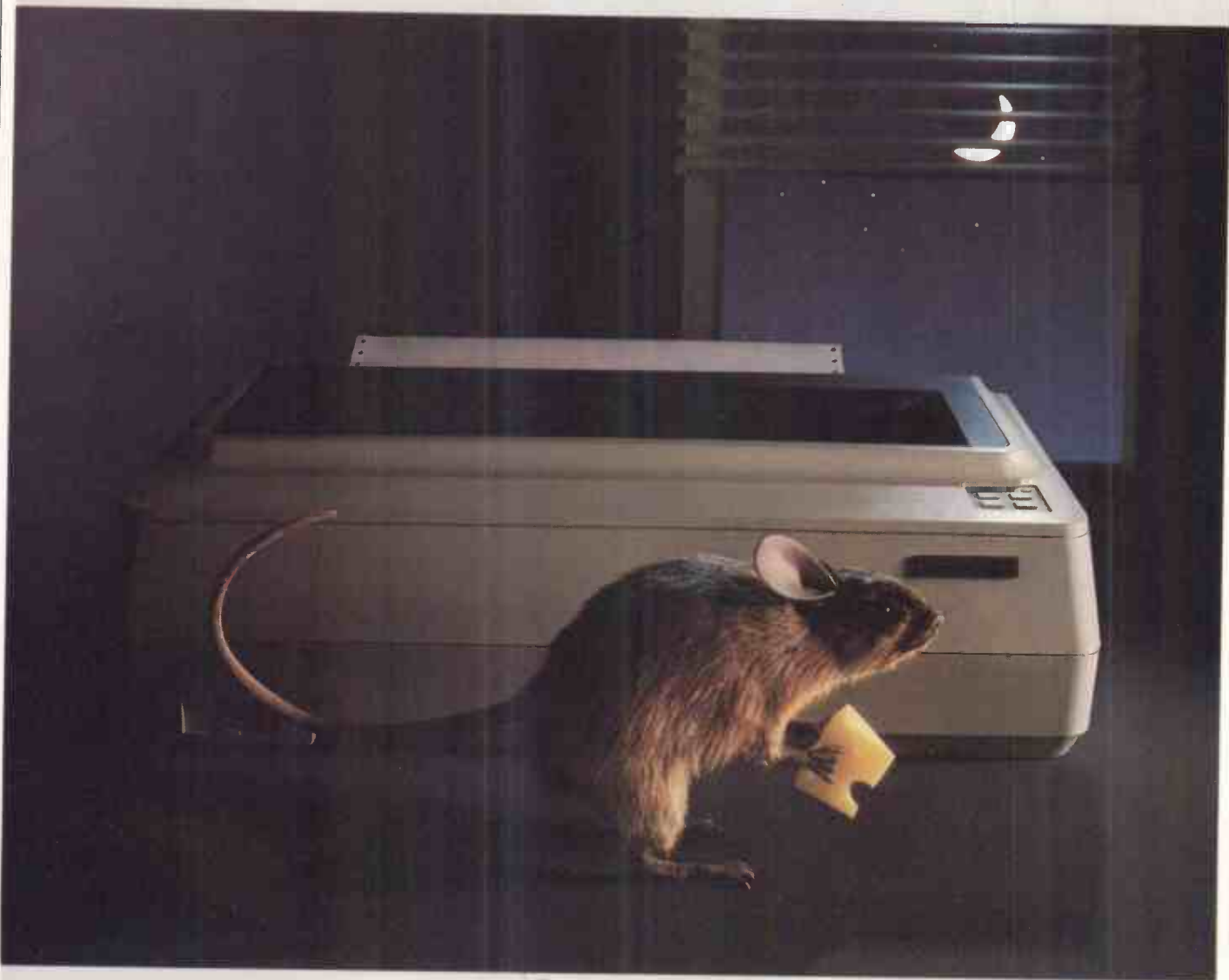

Take a listen to the new MT85 and MT86 serial matrix printers. They're amazingly quiet. Which makes their performance definitely something to shout about.

The MT85 is a compact 80 column printer, while the MT86 offers a full 136 column width. Both print high speed draft output at 180 cps. And high quality

correspondence at 45 cps in various typestyles. Then there's compressed, expanded and bold print for even more variety. And of course graphics.

Flexibility doesn't stop there either. Both printers take continuous fan fold and single sheet stationery in their stride. And they're totally compatible via plug-in interface modules - IBM PC

and Apple Macintosh included.

The new MT85 and MT86 from Mannesmann Tally. Europe's leading matrix printer manufacturer.

The quiet revolution in print. Contact us now for our literature pack.



**MANNESMANN
TALLY**

MANNESMANN TALLY LIMITED, MOLLY MILLARS LANE, WOKINGHAM, BERKSHIRE, RG11 2QT. TELEPHONE (0734) 788711

IBM PC and Apple Macintosh are registered trademarks.

IT LEAVES YOU WITH A GOOD IMPRESSION.

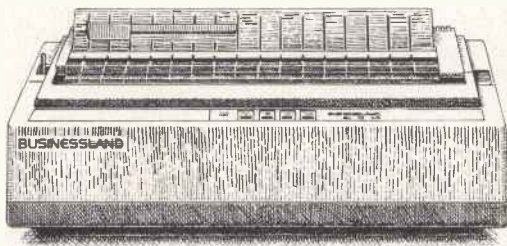

Businessland's proprietary design printer features a controlled strike energy and high quality character profile geometry.

Translated into English, that means it prints a better-looking text.

But that's only one way Businessland's own BL45LQ daisy wheel printer leaves a good impression. It outperforms the "industry standard" printers in many other ways, too.

It's more reliable.

Faster (45 characters a second instead of 40).

Quieter.

And has less circuitry problems because there's less circuitry.

The likelihood of jamming is also minimized because of its unique snap in/out paper handling options.

Call Dovetail Computers and Peripherals Ltd. for a demonstration of a rather astounding value.

Because the BL45LQ printer that does considerably more, costs considerably less.

Can't beat that.

BUSINESSLAND™

Dovetail Computers and Peripherals Ltd., 12 Bridge Rd., Haywards Heath, West Sussex, 0444-457613.

SANYO 550 Series — SUPER Discount Prices

Communications Special: (MI-Term/Nightingale Modem Cable and Serial Interface)	199	Master Graph DC-10	55 25
(plus free registration to Microlink's Telecom Gold System)		MI-Key (Keyboard re-definer)	25
SANYO 550 (1x160k)	669	SANYO CRT 36 Mono Monitor & Lead	120
SANYO 550-3X (2x360k)	869	ZENITH Mono Monitor & Lead	80
SANYO 550-6X (2x800k)	949	EPSON RX80FT with Centronics Cable	269
(All the above with MS-DOS 1.25, BASIC, Wordstar, Calcstar and MONOCHROME MONITOR)		EPSON FX100 with Centronics Cable	539
MS-DOS 2.11 with the above add	35	MANNESMANN TALLY MT80 with Cen Cable	209
SMUA Membership with any Computer	27	BROTHER HR15	399
IBM/Lotus Video Board (MS-DOS 2.11 and GW-BASIC)	145	BROTHER 2024L (100cps NLQ) (Diablo 630 & Epson Compatible)	999
Memory Upgrades 64k (128-192k)	41	Video Board and Lotus 123 (req 256k)	445
128k (128-256k)	75	Graphic Specials:	
Disk Upgrades 2x360k Internal	315	(Grafitti: Freeze Frame: Joystick)	85
2x800k Internal	355	(Picasso: Freeze Frame: Joystick)	118
2x800k External	429	BASIC Manual	27
(All inc Software)		Joystick (2 Button) with ext cable	15
10mb Internal Hard Disk	995	Logitek Screen Handler (Ansi 3.64)	25
MS-DOS 2.11	39	Screen dump (Freeze Frame)	32
Games/Business		Select — Datastar: Report/Label Pgm	25
Serial Interface (RS232)		Desmet 'C' Compiler and 8086 Assem	155
Clock/Calendar Card	49	Desmet 'C' Symbolic Debugger	55
Picasso	70	Superzap	35
		Cornerman (SANYO's Sidekick)	38
		M-Disk (Ram disk program)	25
		Mi-Term (Communications Prog)	65

TURBO PASCAL (IBM, Sanyo, Olivetti, Apple CPM etc)

Turbo Pascal (vers 3)	65	NCS	} All three	130
Turbo Toolbox (Isam, Quicksort etc)	49	Gift Pack		
Turbo Tutor	29	Pack		
Sidekick (IBM & Full Compat Only)	45	Turbo Pascal (v3 With 8087 Support)		99
Sidekick (Unprotected Version)	70	Gift Pack (v3 With 8087 Support)		164
Graphics Toolbox	45			
Superkey	65			

IBM PC/XT Add Ons and Upgrades

20mb Internal Hard Disk	1095	Memory Upgrades 64k RAM	48
Hard Disk Power Supply (Optional)	145	128k RAM	83
24mb Tape Streamer (No slot req)	975	AST Six Pack Plus Multifunction Card	
Mouse Systems — Mouse	Call	(RAM: Serial: Parallel: Clock)	
smARTWORK (PCB Design Package)	895	AST with 64k RAM	275
		AST with 384k RAM (Huge Saving)	395

All major Add Ons/Boards/Software Available — Call for prices.

OLIVETTI M24 Desk Top or M21 Portable (with 640k RAM)

M24 Desk Top or M21 Portable		OLIVETTI M21/M24 Upgrades	
(with 2x360k drives, 640k Ram, HiRes Mono Mon, Keyboard, Serial/Parallel/ Graphics, MS-DOS 2.11)	1999	Memory Upgrades 64k (128k-192k)	55
As above with 2x800k Drives	2199	128k (128k-256k)	99
As above with 1x800k Drive and 1x20mb Hard Disk	3199	512k (128k-640k)	299
		Disk Drives 2x800k	325
		1x20mb Hard Disk	1095
		Software as for IBM	

TELECOM GOLD/COMMUNICATIONS (SANYO/OLIVETTI/IBM)

Nightingale V21/V23 Modem	95	Software	
Cable — Modem to Computer	14	Mi-Term (SANYO)	65
		Crosstalk XVI (IBM, OLIVETTI etc)	155

FREE Registration for Microlink Telecom Gold Box with every modem purchased.

FLOPPIES/PAPER/RIBBONS

BASF or 3M SS/SD 5.25" per 50	70	MX/FX 80 Ribbons per 10	39
BASF or 3M DS/DD 5.25" per 50	99	MX/FX 100 Ribbons per 10	53
Continuous Stationery			
9.5x11 (1pt) per box 2000 sheets	12	9.5x11 NCR 2pt per box 1000 sheets	22
		Paper — Collection Only	

ADD: £10 P&P for each Computer/Printer/Monitor Purchased
Otherwise FREE Postage & Packing
All prices plus VAT at 15%. Manufacturers' Guarantees

Send cheque with order to:

NORTHWEST COMPUTER SUPPLIES (PCC LTD)
82 School Lane, Didsbury, MANCHESTER M20 0RY
Tel: (061) 434 9747

RETAIL Premises — now OPEN — 2 mins M63/A34 Junction

Training Discount Vouchers with each computer
purchased. Upgrade fitting service available



LOOK
LOWER
PRICES

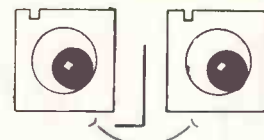

LOOK
QUALITY
DISKS

Same Day
Despatch

WHY BUY ELSEWHERE ?
We will better any genuine delivered price
advertised in the current issue of PCW for Boxes
of Disks shown in the list below.

BOXES OF 10 DISKS	5.25" DISKS		Prices per Box (£)		
	1-4	5-9	10-49		
DYSAN	104/1D HR S/side D Dens	16.50	15.90	15.30	
	104/2D HR D/side D Dens	23.50	22.75	22.00	
	204/1D HR S/side Q Dens	23.95	23.25	22.50	
	204/2D HR D/side Q Dens	27.95	27.35	26.60	
VERBATIM	MD525-01HR S/side S or D Dens	13.75	13.50	13.20	
	MD550-01HR D/side S or D Dens	17.95	17.50	16.75	
	MD577-01HR S/side Q Dens	17.95	17.50	16.75	
	MD557-01HR D/side Q Dens	22.95	22.50	22.00	
	10 or 16 hard sectors at same price. Add £1.20 for library box.				
MEMOREX	3431 HR S/side S Dens	Please Telephone for			
	3481 HR S/side D Dens	MOST COMPETITIVE			
	3491 HR D/side D Dens	Prices			
	3504 HR S/side Q Dens				
	3501 HR D/side Q Dens				
	5500HD D/side H Dens 1.6MB				
BASF	1D S/side D Dens	10.99	10.50	10.00	
	1X HR S/side S Dens	12.50	12.25	11.75	
	1D HR S/side D Dens	13.20	12.95	12.70	
	2D HR S/side D Dens	16.45	16.00	15.00	
	1D/96 HR S/side Q Dens	18.25	17.50	16.75	
	2D/96 HR D/side Q Dens	20.45	20.00	19.50	
	5.25 2D D/side H Dens 1.6MB	34.95	34.00	32.50	
	HR denotes Disks with Reinforced Hub Rings.				
HCK5 Head Clean Kit with Fluid	14.90	14.50	14.00		
LC5 5.25 EGLY Library case	1.90	1.80	1.70		
LB40-5 ABA Lockable Box 40 Cap inc Disk Pen	13.50	13.00	12.50		
LB50-5 ABA Lockable Box 50 Cap inc Disk Pen	14.75	14.25	13.75		
LB90-5 ABA Lockable Box 90 Cap inc Disk Pen	16.50	16.00	15.50		
LB100-5 ABA Lockable Box 100 Cap inc Disk Pen	18.00	17.50	17.00		
VCK-5 Verbatim 5" Head clean kit	6.40	6.20	6.00		
VCD-5 Verbatim 5" H/c disks (per 10)	12.50	12.30	12.10		
DPEN BEROL Quality disk pens (per 12)	5.25	5.00	4.75		
DL-5 Disk Labels 100 (5 colours)	4.50	4.25	4.00		
DM-5 Disk Mailers 4 disk cap (per 100)	21.00	19.50	18.50		
	3.5" DISKS		Special		
SONY	OM-D3440 S/side D Dens	29.95		29.50	
	OM-D4440 D/side D Dens	38.00		37.25	
VERBATIM	MF350 S/side D Dens	32.00	31.25	30.50	
BASF	FD3.5 S/side (Boxed in 5)	16.00	15.50	15.00	
S10-3.5 SEE-10 Library Box	2.30	2.15	2.00		
LB60-3.5 ABA Lockable Box 60 Cap inc Disk Pen	15.50	15.00	14.50		
	8" DISKS				
VERBATIM	FD34-9000 S/side S Den	19.50	18.50	17.50	
	FD34-8000 S/side D Den	19.50	18.50	17.50	
	DD34-4001 D/side D Den	23.00	22.00	21.00	
BASF	1X S/side S Dens	16.00	15.00	14.00	
	1D S/side D Dens	19.00	18.00	17.00	
	2D D/side D Dens	22.00	21.00	20.00	
LB40-8 ABA Lockable Box 40 Cap inc Disk Pen	16.50	16.00	15.50		
VCK-8 Verbatim 8" Head clean kit	6.40	6.20	6.00		
VCD-8 Verbatim 8" H/c disks (per 10)	12.50	12.30	12.10		
	PAPER-LABELS				
PAP1 11"x9.5" 60gsm 2000 Sheets Micro Perf	11.00	10.50	10.00		
PAP3 A4 80gsm 2000 Sheets Micro Perf	24.50	23.50	22.50		
PAP4 A4 90gsm 1000 Sheets Micro Perf	13.50	12.75	11.50		
LAB1 89mmx36mm 2 on web 8000 labels	23.00	22.00	21.00		

RIBBONS - PRINTWHEELS - PRINTERS - SOFTWARE

Telephone or write for very competitive prices on a large range of goods.

OFFICIAL ORDERS ACCEPTED FROM GOVERNMENT OR EDUCATIONAL ESTABLISHMENTS.
Please contact us for Quantity Discounts (50+ boxes) and Trade Accounts.

Description	Quantity	Amount
Postage/Packaging (UK)		
5.25/3.5 Disks, HCK5	£1 /Box* (75p 5+, £5 Max)	Post/Pack
8" Disks, VCD8, CL2	£1.3/Box* (95p 5+, £5 Max)	Total exc VAT
LC5, DL5, VCK5/8, VCD5, DPEN	50p/pack (35p 5+, £5 Max)	Vat @ 15%
Lockable Box, Labels	£2.5/Box (£2 2+, £5 Max)	Total inc VAT
Paper, DM5	£3.5/Box (£2 3+, £15 Max)	
* Add 30p for First Class Post		
Name	Tel. No.	
Address	Post Code	
Access/Barclaycard/Cheque No.		

Telephone Orders Anytime 01-868 9548

Pinner Wordpro

34 CANNONBURY AVENUE PINNER
MIDDX HA5 1TS



NEW AND DEMO STOCK AT MORGAN

(All plus VAT)

APPLE — software

Apple Writer	£45
Apple Quickfile	£35
Multiplan	£43
Visicalc II & III	£43
80 Col Card for 11e	£35
Parallel Card	£30
Serial Card	£45
UHF Modulator	£15
Visiterm/Visished	£35
Visiplot	£35
Extended 80 col(11e)+64k	£75
Business Graphics	£45
Systematics 11e	£xx
Purchase Ledger	£65
Sales Ledger	£65
General Ledger	£65
Stock	£65
Invoicing	£65
Disk Controller	£45
INTEGER Card	£50
Apple Pascal II & III	£45
CCA Database	£35
PFS11 & 111	£25

HARDWARE

Apple Disk Drive	£135
Apple Monitor II & III	£75
Apple 111 inc Mon	£650
Apple EUROPLUS	£225
Apple 11c Drive	£200
Centronics Card	£30
Serial Card	£45
Silentype Printer	£45
Joystick	£15
Grappler Card	£70
Macintosh	£1100
Apple 111 disc drives	£95
Print Mate card	£15

IBM

IBM PC Complete	£1200
IBM Graphics Printer	£295
AST Megaplus Cards	£250
Tallgrass Hard Disk	£600
Framework	£295
Symphony	£350
SDLC	£90
AT Serial Cable	£45
AT Parr/Ser Cable	£80
IBM Portable	£1100
IBM Expansion Unit	£1000
Displaywriter 11	£195
Lotus 123	£225
HMS PC, AT, XT, PORT	£50
PFS series each	£50
IBM PC + 10 meg	£1950
IBM XT	£2500
Dbase 111	£200

ACT

Apricot Twin Drive	
256k inc Monitor	£1100
ACT printer 15	£225
Apricot Portable	£1100
Wordstar	£150
Most Pulsar Grey	£65
Citoh Plotter	£400
Spare Monitors	£100

EPSON

HX 20	£295
QX 10	£800
CX21	£125
Sheet feeder LQ1500	£250
Keyboard DX 100	£100
PX8	£550

OLIVETTI

M10 Modem	£70
Olivetti Jet Printer	£125
Colour Mon. M24	£300
MIO Portable	£250

MISC

HR 25	£450
PR1 Acou Coup	£90
Atari 600xl	£45
Microvitec Mon	£150
HP 86 cpu	£495
Honeywell L32	£295
NEC spinwriter	£700
Rioch 1600 'S'	£550
Seikosha GP 100	£90
VTX modem	£50
Taxan Col mon	£150
Dragon 32	£45
Kaga mon from	£50
Juki 6100	£250
Microwriter	£195
HP 7470A	£600
HP 7475	£995
Buzz Box Modem	£45
Oric Atmos	£45
Oric 4pen Plot	£60
Compaq Port	£1300
Hyperion 256	£1100
Enterprise 64	£150
Sharp MZ 80B	£395
Sharp P6 printer	£195

SANYO MBC 2000

12" GREEN SCREEN twin	
320k drives cpm	£395
Over 300 discs	
P/D software	
available	

MORGAN CAMERA COMPANY

179 TOTTENHAM COURT ROAD, LONDON W1

Tel: 01-636 1138

MONITORS

Microvitec 1431 Standard Res.....	£189.00
Microvitec 1451 Medium Res.....	£289.00
Microvitec 1441 High Res.....	£399.00
Microvitec 2031 20" Standard Res.....	£315.00
Microvitec Sinclair QL.....	£270.00
Philips BM7502 V.H. Res (Green).....	£85.00
Normende TV/Monitor + Remote control	£249.00
Ferguson CTV + RGB.....	£240.00
Philips CTV + RGB.....	£229.00
Kaga RGB Vision III 12".....	£369.00
Kaga 12" H.R. Green.....	£118
Sanyo SCM 14" VHR.....	£425.00
Novex 1414 colour Monitor.....	£215.00

DISC DRIVES

BBC Single 100K Drive.....	£99.00
BBC Dual 200K.....	£189.00
BBC Dual 200K 40 Track.....	£159.00
BBC Dual 400K 40 Track.....	£299.00
BBC Single 400K 80 Track.....	£159.00
BBC Dual 800K 80 Track.....	£318.00
BBC Single Power Supply.....	£20.00
BBC Dual Power Supply.....	£29.00

DAISYWHEEL PRINTERS

Brother HR15.....	£378.00
Brother HR15 Keyboard.....	£155.00
Brother HR15 Sheet Feeder.....	£212.00
Brother HR15 Tractor Feed.....	£71.00
Quen Data 20 CPS.....	£249.00
Juki 6100 18 CPS.....	£340.00
Juki Single Sheet Feeder.....	£230.00
Juki Tractor Unit.....	£115.00
Juki RS232 Interface.....	£74.00
Juki Spare Daisywheel.....	£16.00

PRINTERS

Brother EP44.....	£228.00
Brother HR5.....	£148.00
Canon PW1080A 160 CPS (NLQ).....	£289.00
Canon PW1156A 160 CPS (NLQ).....	£399.00

Kaga KP810 (NLQ).....	£285.00
Kaga KP910 (NLQ).....	£399.00
Kaga RS232 + 2K Buffer.....	£95.00
Ensign 1650 165 CPS.....	£305.00
Epson RX80T 100 CPS.....	£212.00
Epson RX80F/T 100 CPS.....	£240.00
MP-165 (NLQ).....	£316.00
Panasonic KP1091.....	£325.00
Seikosha GP100A.....	£189.00
Epson RX100F/T 100 CPS.....	£396.00
Epson FX80 160 CPS.....	£370.00
Epson FX100F/T 160 CPS.....	£494.00
Shinwa CP80.....	£199.00
Riteman Compact 120 CPS.....	£199.00
Star Gemini 10X 120 CPS.....	£230.00
Star Gemini 15X 120 CPS.....	£339.00
Epson 814RS232 Interface with 2K Buffer X On/Off.....	£65.00
Epson LX80.....	£245.00
LX80 (New Edition).....	£225.00

COLOUR PRINTERS

Canon PJ1080A 7 Colour 40 CPS Ink Jet.....	£440.00
Seikosha GP700A 7 Colour 50 CPS.....	£399.00

**COMPUTERS, SOFTWARE,
ACCESSORIES, UTILITIES
and lots, lots more!!**

DISKS

Very high quality Fuji
Diskettes, guaranteed for life
at only £20.00 per box
(Double-sided 80 track)

BBC UPGRADES

A-B Upgrade.....	£110.00
DFS Interface.....	£120.00
Econet Interface.....	£69.00
Speech Interface.....	£54.00
RS232 Interface for any Centronics-type Printer.....	£34.00

HOW TO ORDER

You may purchase any of the items listed by cheque made payable to: Twillstar Computers Ltd. Barclaycard or Access. All you have to do is fill in your requirements on a separate sheet of paper, post to us and we will despatch within 24 hours, subject to availability. All prices inclusive of 15% VAT. ADD £2.50 P&P for orders below £150. Over add £8 P&P. Credit card holders may order by telephone. Give card number, name, address and items required. Please note VAT is not charged on export orders. Export customers please ring for details of P&P.



TELEPHONE ORDERS
(01)574 5271

Open
8 days a week
9am to 7pm
Monday to Saturday



Twillstar Computers Limited

17 Regina Road, Southall, MIDDLESEX UB2 5PL. TEL: (01)574 5271

RM NIMBUS

POWERFUL. FLEXIBLE

AFFORDABLE

AVAILABLE

Research machines Nimbus: 16 bit super micro.

You've read the rave reviews — now try a demonstration. The new RM Nimbus can be seen and tested immediately.

Complete with full range of software, including: word processing, spread sheet, database, accounts and graphics.

- * The fastest 16 bit business computer
- * Built-in colour hi-resolution graphics
- * 80186 Main processor running at 8 MHz
- * RM graphics processor
- * 8051 peripherals processor running at 11 MHz
- * 8910 sound processor running at 11 MHz
- * MS DOS version 3.05 operating system
- * 192 K standard RAM expandable to 1 megabyte
- * 2 x 720 K disk drives as standard
- * Hard disk option — 10, 20, 40 or 80 megabyte
- * Networking up to 64 stations
- * Interfacing up to 30 peripherals devices can be attached, (printers, instruments, modem, etc)
- * Full range of software now available
- * MS word mouse driven word processor
- * MS multiplan spreadsheet
- * Superfile database
- * Pegasus, Sage, multipac accounts packages
- * CAD packages
- * Mouse and joystick operated painting packages
- * Powerful RM basic, Logo and Pascal languages
- * And much, much more

Telephone straightaway for an instant trial

Regional Systems

2 Greenleaf Road, Walthamstow, London E17 6QQ

Telephone: 01-521 7144



Herbie Briggs has just destroyed the myth that all floppy discs are created equal.

They seem equal. Until you look at the seams.

That's where equality ends.

Most companies seal their discs with a spot here, a spot there. Leaving most of each seam not sealed at all.

Sooner or later, the seams might do what comes naturally: they bulge. Warp. Pucker. Open up.

Pens, pencils, fingernails—even a four-year-old's, like Herbie—can catch and snag in those wide open spaces.

That's sloppy. And dangerous. Because if you put a sloppy floppy into your disc drive, it can jam your drive. Ruin your drive head. Lose your data.

So much for their seams. Ours are different.

THE SLOPPY FLOPPY:

Sealed with a spot here, a spot there. Leaving unsealed seams everywhere.

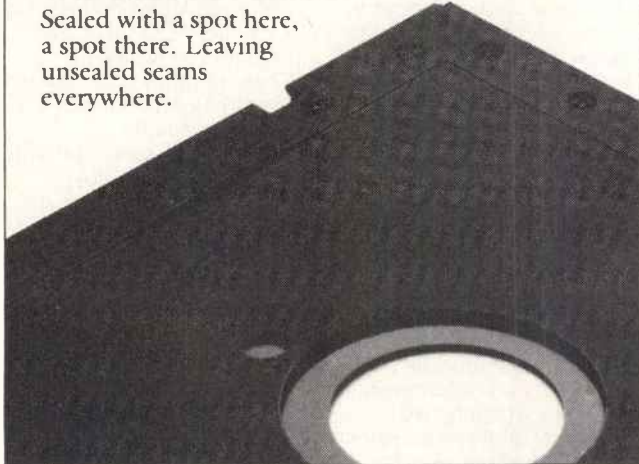

Memorex uses a process we developed, called Solid-Seam Bonding.

Solid-Seam Bonding seals shut every inch of every seam of every Memorex* floppy disc. Tight as a drum. That makes the Memorex

floppy stiffer. Stronger. And your data safer.

To resist bulging, warping, puckering, or opening up.

MEMOREX SOLID-SEAM BONDING:

Every inch of every seam is sealed shut. Tight as a drum.

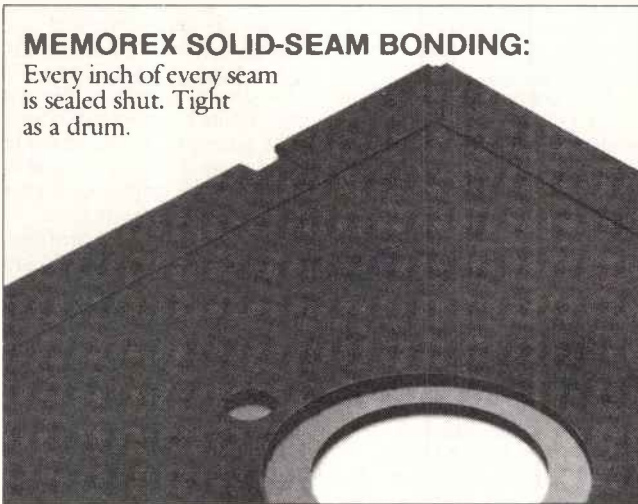

To resist all the things that can jam your drive, ruin your drive head, or lose your data.

Which proves that a Memorex floppy disc isn't equal to all the others. It's better.

Solid-Seam Bonding is just one example of the extra care that goes into every Memorex floppy disc. Be it 8", 5¼" or the new 3½" Extra care that lets us guarantee every Memorex disc to be 100% error-free.

The next time you're buying a floppy disc—or a few hundred of them—just remember this:

It's always better to be safe than sloppy.

For more information on the full line of Memorex quality computer media products, including computer tape, call Memorex U.K. Ltd., 96-104 Church Street, Staines, Middlesex. Tel: 0784 51488



Your Data. When it matters, make it Memorex.™

MEMOREX

Memorex is a registered trademark of Memorex Corporation.

© 1984 Memorex Corporation

AUGUST 1985 PCW 109



Error-correcting comms is offered by a new British invention, MultiStream, and Robert Maxwell extends a helping hand to Sinclair. Read all about it, courtesy of Guy Kewney.

MultiStream synchronisation

British communications people have come up with MultiStream, which attempts to do part of the job performed by Microsoft's intriguing X-PC.

MultiStream does not offer the X-PC feature of connecting a user to 15 different databases simultaneously, but it does offer error-correcting comms, and it does it by sending asynchronous packets.

Packet switching involves sending blocks of data instead of single characters, and checking mathematically to ensure that the blocks get there intact.

On the X-PC protocol, Microsoft has added the (logical enough) feature of saying that the packets can behave in exactly the same way as they do when the big boys are playing with them.

They don't just say how big they are, but also where they are going.

That's how you get connected to more than one database at a time. Your software has to keep track of which database you're talking to, and put the right address on the packets.

MultiStream has a different job to do: it has to make sure that people are sending data at the right speed.

Our European way of getting ultra-cheap modems is to use simple-minded hardware, which can transmit at 75 bits per second (about the speed of the slowest typist in the world) but can receive at 1200 bits per second, rather faster than you can read.

This only causes problems if you're trying to send a letter to someone, with your software pretending to be the slowest typist in the world.

This Newsprint column, for example, runs to about 7000 words each month. I will never forget the time I prepared it on an Apricot, and transmitted it to PCW's editorial offices at 75 bits per second.

If it had gone without trouble, it would have taken

two hours or more, but in fact, Telecom Gold got into an argument with Packet SwitchStream half way through and lost the lot. The second time, it got about two paragraphs further on and found an ordinary WordStar character which I didn't know I'd left there, by mistake, and obediently stopped receiving.

The new Epad service allows your modem to switch about, so that it can send at 1200 bits per second. Software to take advantage of this Epad service is already on the market. United Information Services, producer of the excellent Unicom RAP program, has produced one called Hush for the IBM and its compatibles, the Apricot and the TI Professional.

RAP, by the way, is the one reliable way of using the Apricot internal modem without ACT's own Communique or Micromail programs.

When Lion House's Comm is fully debugged, that will be an alternative, but at the moment, RAP is by far the quickest and most reliable program for driving that modem. But it does require more than 256k of memory.

UIS, which is the original owner of the Unicom name, should not be confused with the Demon, which was first launched as the Unicom before UIS objected. Contact UIS on (03727) 29655.

Another software package to support MultiStream comes from ACT — a new version of Communique. This costs £395, including a plug-in modem for the Apricot. For existing Communique users, there is a £95 upgrade charge.

The only obvious caveat is that there are only two expansion slots on an Apricot, and if you want to expand memory (and you do), that will use them both up. After memory and modem, you can't plug in anything else.

Sinclair Research.

He (Sinclair) didn't want to run the company himself, he said, and never pretended he had wanted to.

There were no problems with the accounts, and the whole report that there was a delay was 'nonsense' and he had no idea how it had come to be suggested that there was.

Plans for new Sinclair Research projects had not been held up by uncertainty, nor was there any chance that they would go ahead any faster now.

There's no need to doubt this, for one good reason: had Sinclair Research really been in terminal trouble, then people might have waited for it to crash before buying the bits from the receiver.

On the other hand, £15m doesn't sound a lot for Sinclair Research, and Robert Maxwell, the high-profile technofreak who is now becoming chairman, is almost as hardline a patriot as Sir Clive himself.

Maxwell and Sinclair have shared a board before, 15 years ago, on Cambridge Consultants. They've been on good terms ever since, and although Maxwell is a Labour Party man and Clive was knighted by Margaret Thatcher, they both regard the UK as deserving of the best they can do.

Sir Clive wants to provide this country with the necessary technology, in silicon, for the next couple of decades. Maxwell agrees.

As far as the rest of us are concerned, however, the most important immediate consequence is that Sinclair Research is no longer under a financial cloud, and that the portable Spectrum, another portable and the cellular radio projects can all go ahead.

The Metalab remains part of Sinclair Research, and Clive will now receive a fee, through his own company (Sinclair Ltd, or something like that) to be the tame inventor and R&D director, effectively leaving Sinclair Research.

The car project remains Clive's. Also left with him is his planned fifth generation project, which is still only a gleam in the inventor's eye, needing 'hundreds of



I'm a sucker for these gadgets — things costing £10 which do work you could do with a pair of scissors. This one takes the sprocket holes off wedges of computer printout. It'll cut perforated or unperforated paper, says Associated Computer Supplies, and any fool can use it. It has pegs to hole the sprocket holes, and a blade to clamp over the margin. If I can get hold of one, I'll be able to fit my printout into envelopes without folding it. Details on (0782) 632178.

Uncle Clive and Captain Bob

To talk to Sir Clive Sinclair, you'd think that there were no 'problems' attached to Robert Maxwell's refinancing of

millions' to develop.

We'll keep wishing him luck, I suppose.

Orika!

You were wondering what had happened to Oric? It is sold.

The buyer is Eureka Informatique, described in the announcement as 'the leading independent distributor of home computers in France'. This company has a factory in Normandy, where it will now assemble the machine (the factory already assembles colour displays for the micro).

Anyone with a need to get in touch should contact John McKay Associates, which is handling publicity for the new outfit, on (01) 734 4554.

One bad apple

You can forget all about seeing a fast Macintosh, or a colour Macintosh, this year. The project has been put on ice. The reason? Personnel changes at the top level.

My contacts in the software business say they are pleased to see Steve Jobs, founder of Apple, forced to take a back seat in the struggle with the man he hired, John Sculley. The phrase used by one (who obviously wants to stay anonymous) was: 'The folks in charge don't include some whose egos were rather too involved in their work,' and he meant Jobs.

On the other hand, the news is not really all that good because the 'ego' of Jobs was heavily involved in the Macintosh.

It remains true that Apple's fortunes were built on the Apple II, and that without it, the corporation would be lost. Even today, most of the money that flows in comes from the IIe and IIc, and the machine still needs development.

But if the company has a future, that future lies with the Macintosh. And a full halt has been called in Macintosh development, now that Jobs has been relieved of control of that.

A Macintosh with more memory — both disk and RAM — was due out in September. That has been postponed, indefinitely. And the colour Macintosh, scheduled for February 1986, is equally abandoned — not permanently, but for some time.

This has got to be a mistake. The Atari ST has both speed and colour advantages over the Mac (see June's *PCW*), and the

Commodore Amiga (reviewed in this issue) has even more of both. Apple invested a fortune in getting the first low-cost icon machine onto the market, and it has a whole year's start on those two, especially in software.

But this is not the time for Apple to go to sleep! Getting software started on the Macintosh was hard. Getting versions of things already written for the Motorola 68000 and icons onto another machine with the Motorola 68000 and icons isn't more than about two months' work.

I don't expect Commodore's Amiga to be fully debugged until Christmas. The Atari ST may well take longer. Even so, at the prices those two will be selling for, a lot of potential customers are bound to be tempted, and the only thing that can keep Apple right in front is hard work.

Publicly, of course, Apple is saying that 'nothing has changed' and that if it looks necessary to compete with Atari or Commodore, it will respond.

But the truth is that software houses are not going to continue burning the midnight oil on colour versions of their Macintosh software if the company isn't fully committed to producing the colour Mac.

And everyone who has ever used a Mac is agreed that the thing is wonderful, but slow and short of disk space. Included in those people are software authors.

Talking about 'Steve Jobs taking on a more global role in new product innovations and strategies' is polite flannel for saying that things had to change. Many in the business believe that, and who knows — it may be true.

But sacrificing the lead Macintosh in the icon-micro market is not going to pacify the gods who say: 'The Apple II is nearing the end of its life,' because that time is coming.

Even if the 6502 chip were usable in reliable multi-tasking (and it isn't), it has already reached the effective speed limit of its design. Even if it could address a megabyte of memory, as the IBM PC chip can, it wouldn't be possible to standardise it on a system, at this stage, for software houses to use the extra.

But worst of all, the 6502 has no big brother, and the 8088 has the 80286, which is already out in the market. There is very little difference between the IBM PC and the Apple IIe, apart from that — but that is enough.



The fact that the Commodore 128 (reviewed in July) will run CP/M software when it is released has prompted a lot of philosophers to indulge themselves long-windedly about the return of CP/M, just when we thought it was going to disappear. Indeed, I seem to remember doing something similar myself when ruminating recently over the Tatum and Amstrad machines.

Actually, the 128 may do something for CP/M which hasn't been seen before. The machine includes the option of a RAM disk, and a great deal of CP/M software, which was unmanageably slow from floppy disk, can be acceptably fast from a good RAM disk.

Nevertheless, I expect people to be more impressed with the repackaged 64, with the option of buying £430 worth of peripherals, including disk and modem (plus Compunet subscription) for £229.

After the own goal which Commodore scored by releasing the Plus 4, the 64 took quite a hiding, and this offer may save it — or at least, it may keep the company making money long enough to get the 128 launched. And the attempt to turn the Plus 4 into a business system by including a disk and a printer may not turn it into a best-seller, but at least it stops people getting confused, in shops, over whether to buy the 64 or the Plus 4.

Anyway, for CP/M fans who really believe that it's coming back, Davis Rubin Associates has a book of 'free software', the public domain programs that have grown up around these machines.

The company says that 'the problem with public domain software has always been the lack of good documentation', and this is its attempt to sort that out.

There are £10 worth of free programs supplied with the book for £27.95, or the book alone costs £17.95. You have to supply your own pre-formatted diskettes, enough to hold 1200k, and Davis Rubin Associates copies the stuff onto them for you.

The book is published by PeopleTalk Associates in Texas, but Barry Rubin and Jane Davis are in the UK, on (0386) 841181.



SHEKHANA COMPUTER SERVICES

COMMODORE 64	RRP	Our Price	SPECTRUM	RRP	Our Price
ELITE	14.95	10.90	HERBYS DUMMY RUN	9.99	7.20
ON COURT TENNIS	8.95	6.75	FRANKIE GOES TO HOLLYWOOD	9.99	7.50
ON FIELD FOOTBALL	10.99	8.99	DALEY TOMS SUPERTEST	6.95	5.25
STAR LEAGUE BASEBALL	10.99	8.99	STREET HAWKS	6.95	5.25
WEB DIMENSION	10.99	8.99	JET SET WILLY II	6.95	5.25
BEACH HEAD	9.99	7.45	GLASS	9.99	7.95
MR DO	9.95	7.95	A VIEW TO KILL	10.99	8.50
FRANKIE GOES TO HOLLYWOOD	9.99	7.50	DUN DARACH	9.99	7.50
DALEY TOMS SUPERTEST	7.95	5.90	TAPPER	7.95	5.90
DAM BUSTERS	9.99	7.50	ARCHON	10.95	8.50
RAID OVER MOSCOW	9.99	7.50	SPY V SPY	9.99	7.25
INT. BASKETBALL	9.99	7.50	HARD HAT MAC	8.95	6.95
JUMP JET	7.90	4.99	ONE ON ONE	8.95	6.95
DALEY TOMS DECATHLON	7.90	5.90	TALES OF THE ARABIAN NIGHTS	5.50	4.25
FIGHTER PILOT	9.99	7.45	DALEY TOM DECATHLON	6.90	4.99
FIT TOP II	10.99	8.40	SPY HUNTER	7.95	5.90
DROPZONE	9.99	7.95	EVERYONES A WALLY	9.99	7.20
HERBY DUMMY RUN	9.99	7.20	BEACH HEAD	7.95	5.90
STREET HAWKS	7.95	5.90	RAID OVER MOSCOW	7.95	5.90
SPY HUNTER	9.99	7.50	TIR NA NOG	9.99	7.50
SPITFIRE 40	9.99	7.50	THE FOURTH PROTOCOL	12.95	9.99
A VIEW TO KILL	10.99	8.50	CAULDRON	7.99	5.99
AIRWOLF	7.95	5.90	FIGHTER PILOT	7.95	5.90
SPELUNKER	9.95	7.95	STARION	7.95	5.90
THE FOURTH PROTOCOL	12.95	9.99	BRUCE LEE	7.95	5.90
F15 STRIKE EAGLE	14.95	11.20	ALIEN 8	9.99	7.50
ARCHON	11.95	8.95	REALM/IMPOSSIBILITY	8.95	6.95
IMPOSSIBLE MISSION	8.95	6.75	WARLORDS	5.50	4.25
RAID ON BUNGLING BAY	9.99	7.45	HOBBITT	14.95	9.99
TIM LOVES CRICKET	8.95	7.50	AMSTRAD		
EVERYONE'S A WALLY	9.95	7.20	DALEY TOMS SUPERTEST	8.95	6.75
DIG DUG	9.95	7.95	DUN DARACH	9.99	7.50
ENTOMBED	9.95	7.50	STREET HAWKS	8.95	6.75
CAULDRON	7.99	5.99	AZIMUTH (HEAD ALIGNMENT)	8.95	6.90
AZIMUTH (HEAD ALIGNMENT)	8.95	6.95	ARCHON	10.99	8.50
ROCKY HORROR SHOW	8.95	6.95	HARD HAT MAC	8.95	6.95
HARD HAT MAC	9.99	7.45	ONE ON ONE	8.95	6.95
REALM/IMPOSSIBILITY	9.99	7.45	ALIEN	9.99	7.50
GROGS REVENGE	9.99	7.45	KNIGHTLORE	9.99	7.50
WAY OF EXPLODING FIST (KIKI)	9.95	7.50	BBC/ELECTRON		
WARLORDS	7.00	5.25	COMBAT LYNX (BBC/ELEC)	8.95	6.75
JEWELS OF BABYLON	7.00	5.25	HAMPSTEAD (BBC/ELEC)	7.95	5.90
STRIP POKER	9.99	7.50	REVS	14.95	11.25
MATCH DAY	8.95	6.75	ATIC ATAC	7.95	5.95
			ALIEN 8	9.99	7.50
			KNIGHTLORE	9.99	7.50

For mail order all prices include P&P in UK. Europe add 75p per tape. Elsewhere at cost. Send your cheque/PO payable to: SCS, Dept CPW, 653 Green Lanes, London N8 0QY. Tel no: (01) 800 3156. SAE for list or

If you want to pick up your discount software direct from our shop please bring along your copy of this advert. Come to "Marbles Shopping Centre" Unit 11-12, 521-531 Oxford St, London W1R 1DD (1 min from Marble Arch tube stn). Further titles & offers available at our shop which is open 7 days a week from 10AM-7PM.

3 1/2" FUJI Microdisks

SS/DD **£29.95**
DS/DD **£39.95**



PRICES PER BOX

	1-4	5-9	10+
SS	29.95	29.50	29.10
DS	39.95	39.30	38.70

Full Lifetime Guarantee

SPECIAL OFFER

5 1/4" FLOPPY DISKS

Suitable for use on nearly all single and double-sided 5 1/4" disk systems.

- Replacement Guarantee
- Hub rings
- Bored in 10s

PRICES PER BOX

	1-4	5-9	10+
DS/DD	9.90	9.00	8.60

99P

EACH
(Bored in 10's)
EXCL VAT

REPLACEMENT GUARANTEE

If any disk should fail, return it for free replacement.

DELIVERY

	1-4	2-4	5+
Disks (per box)	75p	50p	40p
Library Cases	60p	30p	25p

(Free with disks)

SEE 10 LIBRARY CASES
(Hold 10 disks)

	1-4	5-9	10+
5 1/4"	1.99	1.85	1.75
3 1/2"	1.99	1.85	1.75

HOW TO ORDER

To total order value add Delivery, then add 15% VAT and send to:

IDS Computer Supplies
P.O. BOX 438, BANCROFT, MILTON KEYNES MK13 0QX. Tel: (0908) 310696.

BIGGER STOCKS

GARWOOD IS GROWING!

(and you can reap the benefit)

CHEAPER PRICES

DISKS		TPI	DYSAN		3M		MEMOREX		BASF		MAXELL	
Price per box of 10			1-4	5-9	1-4	5-9	1-4	5-9	1-4	5-9	1-4	5-9
5 1/4"	S/S S/D	48					15.60	14.70	14.60	13.70		
	S/S D/D	48	17.25	16.20	15.10	14.20	17.10	16.00	17.60	16.50		
	D/S D/D	48	25.30	23.70	20.70	19.40	20.60	19.30	21.50	20.20		
	S/S Q/D	96	25.30	23.70	23.10	21.80	24.70	23.20	23.10	21.70		
8"	D/S Q/D	96	31.80	29.80	27.00	25.30	27.40	25.70	26.80	25.20		
	S/S S/D	48			16.80	15.75	19.80	18.50	15.20	14.30		
3"	S/S D/D	48	24.70	23.15	21.75	20.40	20.80	19.50	20.00	18.80		
	D/S D/D	48	29.30	27.45	25.05	23.50	27.10	25.40	23.80	22.30		
3" Compact (for the Amstrad Disc Drive)											39.00	36.00
3 1/2" Micro		S/S D/D	135				41.80	39.20				

Disc prices are exc. VAT but inc. carriage. S/S = Single Sided D/S = Double Sided S/D = Single Density D/D = Double Density Q/D = Quad Density

STOP PRESS - NOW AVAILABLE MAXELL 3" Compact Disks available in individual storage case. £4.60 inc VAT & POSTAGE
GREAT NEW OFFER - 1,000 LABEL-TRACK® 3 1/2" x 1 7/16" Computer Labels in flip top dispenser £5.75 inc VAT & POSTAGE

RIBBONS supplied for most printers (including the Amstrad DMP1 @ £6.50 inc VAT + Postage) Prices on Application

LISTING PAPER (plain or ruled)	Price per box	Boxed	1-4 boxes	5-9 boxes	10+ boxes	
11" x 8 1/2"	1PT 60gsm	2000	9.45	8.85	8.55	Listing Paper prices are exc. VAT. Delivery free within 15 mile radius of Brentwood. Carriage at cost outside this area.
11" x 9 1/2"	1PT 60gsm	2000	10.05	9.40	9.10	
11" x 9 1/2"	1PT 70gsm	2000	11.40	10.70	10.35	
11" x 9 1/2"	2PT NCR	1000	15.40	14.40	13.95	
11" x 14 1/2"	1PT 60gsm	2000	13.80	12.90	12.50	

PRINTER OFFER - MT80+ Matrix Printer 100 c.p.s. RRP £217+VAT OUR PRICE £217 inc VAT+carriage.

GARWOOD'S STATIONERY CATALOGUE - Full colour 224 pages - £1.75 inc postage



Garwood (Wholesale) Limited



45 Plovers Mead, Wyatts Green, Essex CM15 0PS ☎ Blackmore (0277) 823747

CHROMASONIC Computer Centres

48 Junction Road, Archway, London N19 5RD
238 Muswell Hill Broadway, London N10 3SH

PHONE

01-263 9493/5 or 01-883 3705

Apple Hardware

Phone for Mac
System Price

£	//c	£
MAC 512k.....	1800	System Price 1177
MAC 128k.....	1345	Apple //c.....
MAC Disk Drive	255	D/Drive //c....
Imagewriter. 10"	285	Monitor //c....
Imagewriter. 15"	425	Mon. Stand.....
Accessory Kit.....	30	Mouse//c.....
MAC Upgrade.....	655	Apple Works....



apricot hardware

£	P.O.A.	PRINTERS	£
F1. Range.....		EPSON FX80.....	347
PC 256k D/D315k.	1299	RX80 F/T.....	239
PC 256k D/D720k.	1469	RX100.....	385
Xi 10MB ram256k.	2290	new LX80 NLQ....	255
Xi 20MB ram512k.	3115	CANN.PW1080....	308
9" Monitor.....	164	MP 165 NLQ.....	260
12" Monitor.....	200	JUKI 6100.....	347
modem board.....	242	D/STEP 2000....	250

Terms

Payment by Access, Visa, Bankers draft, Building Society cheque, Sorry Cheques take 5 days clearance. We reserve the right to change prices without prior notice. Please check for carriage charges before ordering. All prices exclude V.A.T.

NEW from

NEC



APC III

1.4 MB dual floppy
from £1499

11 MB hard disk + floppy
from £2399

QUALITY BUSINESS/PROFESSIONAL MICROCOMPUTER

- HIGH SPEED: 8 MHz 8086-2 true 16 bit processor.
- HIGH CAPACITY: 720 kB per 5¼ inch fast floppy. 10.7 MB per hard disk (1 or 2).
- HIGH RESOLUTION: 640 × 400 dot text & graphics.
- HIGH QUALITY/RELIABILITY: Japan's top micro co.
- HIGH VALUE FOR MONEY: very competitive prices.

PROFESSIONAL FEATURES

- STANDARD MSDOS 2.11 operating system.
- HIGH LEGIBILITY 14 inch mono or colour screen, tilt/turn base, double defn. characters (8×16).
- FULL 100 KEY KEYBOARD ideal for word processing. 12 function keys give up to 60 functions.
- 128kB to 640kB memory expansion.
- 32 BIT ARITHMETIC PROCESSOR available (8087-2).
- 640 × 400 × 8 COLOUR GRAPHICS card available.
- GSX GRAPHICS STANOARD software available.
- READS 360k IBM PC disks. Supports IBM printer.
- SERIAL & PARALLEL communications/printer ports.
- IEEE-48 card available.

SOFTWARE

- MSDOS 2.11, GW-BASIC, Communications software.
- FREE text editor/calculator/typewriter software.
- FREE Icon user-friendly front end (needs 256k).
- ACCOUNTS: Sage, Pegasus, Multisoft etc.
- WORD PROCESSING: WordStar, Spellbinder, Lex etc.
- DATABASE: DBASE II, Delta, Sensible Solution etc.
- SPREADSHEETS: SuperCalc 2 & 3, Multiplan etc.
- AUTOCAD: Computer Aided Design — superb!
- LANGUAGES: C, CBASIC, COBOL, FORTRAN, PASCAL etc.

OTHER NEC BARGAINS

NEC SPINWRITER 20 chars/sec quality printer: £425
NEC PC-8201 16k battery portable computer: £299

(Prices exclude 15% VAT)

Brighton Computer Centre

130 Lewes Road, Brighton BN2 3LG
(0273) 673114 Mon-Sat 10am-6pm

Name

Company

Address.....

..... Tel

Application PCW 8/85

BBC MICRO COMPUTER SYSTEM

BBC Computers

Model B.....	£299 (a)	6502 Second Processor.....	£175 (a)
Model B + NFS.....	£335 (a)	Acorn IEEE Interface.....	£280 (a)
Model B + DFS.....	£346 (a)	Z80 2nd Proc. + Software.....	£348 (a)
Model B + DFS + NFS.....	£399 (a)	Bitstick + graphics Software.....	£325 (a)
BBC B Plus (available from stock).....	£409 (a)		

TORCH UNICORN PRODUCTS:

ZEP100 Z80 Card with 64K Ram + Free Software Package.....	£275 (a)
ZDP240 Z80 Card with 2 x 400K Dual Drive + Software.....	£625 (a)
HDP68K + UNIX 68000 with Z80B & UNIX OS.....	£3495 (a)
GS800 GRADUATE 8086 + 256K RAM + Dual Drive + Xchange Software.....	£925 (a)

In addition to above we carry a very wide range of BBC firmware & software packages. Please write for further details.

SANYO COMPUTER SYSTEM

SANYO'S MBC 555 Series featuring 16 bit 8088 CPU with powerful MS-DOS operating system. 256K on board ram with a dual drive system offering 360K or 720K storage capacity. Detachable keyboard with 81 keys including 5 user definable function keys. RGB/Composite Video with hi res 640 x 200 8 colour display. Centronics port as standard. Supplied with Systems discs, Sanyo BASIC and utility software which includes Professional WORDStar, DATAStar, SUPERSORT and CALCStar.

SANYO MBC 555-2 360K Drive.....	£1099 (a+b)
SANYO MBC 555-2 720K Drive.....	£1199 (a+b)

FREE SANYO Hi Res GREEN SCREEN MONITOR WITH THE COMPUTER

PRINTERS

EPSON

RX80T £210(a)	RX80FT £220(a)	RX100 £345(a)	FX80 £315(a)	FX100 £430(a)
JX80 Full Colour Printer £525(a) H180 Plotter £399(a)				
LX80 Special Introductory Price £242(a)				

KAGA TAXAN NLO Printers
KP810 £225(a) KP910 £349(a)

DAISY WHEELS

JUKI 6100 £325(a)	BROTHER HR15 £325(a)
-------------------	----------------------

PRINTER ACCESSORIES

EPSON

Serial Interface: 8143 £28(b);
8148 with 2K buffer £59(b).
32K Parallel Buffer £99(b)

Paper Roll Holder £17(b);
FX80 tractor Attachment £37(b)
Ribbons: MX/RX/FX 80 £5(c);
MX/RX/FX 100 £10(c).
Dust Covers: RX/FX 80 £4.50(c);
RX/FX 100 £6.50(c).
LX80 Tractor Unit £20(c)
Spare Pens for H180 £7.50(d)

KAGA Serial I/Face with 2K Buffer £65(c)
Ribbon £6(c)

JUKI Serial I/Face with 2K Buffer £60(b);
Ribbon £2.50(d).

JUKI Sheet Feeder £180(a);

Tractor Feed £129(a).

BROTHER HR15 Sheet Feeder £199(a);

Tractor Feed £99(a).

2000 Fanfold sheets with extra fine perforations

9.5" x 11" £13.50(b); 14.5" x 11" £17.50(b).

Self Adhesive Labels 3 1/2" per 1000.

Single Row £5.25(d); Triple Row £5(d).

Parallel Leads: IBM £18(c); BBC £7(c).

TECHNOLINE VIEWDATA SYSTEM

Using 'Prestel' type protocols

For information and orders phone:

01-450 9764.

24 hour service, 7 days a week.

MODEMS

All modems listed below are BT approved

MIRACLE WS2000:

The ultimate world standard modem covers all common BELL and CCITT standards up to 1200 Baud. Allows communication with virtually any computer system in the world. The optional AUTO DIAL and AUTO ANSWER boards enhance the considerable facilities already provided on the modem. Mains powered £129(b). Auto dial Board/Auto Answer Board £30(c) each awaiting BT approval. Software lead £4.50.

BUZZ BOX:

This pocket sized modem complies with V21 300/300 Baud and provides an ideal solution for communications between users, with main frame computers and bulletin boards at a very economic cost. Battery or mains operated, £62(c). Mains adaptor £8(d).

BBC to Modem data lead £7.

EPROM PROGRAMMERS

Industrial Programmer P8000.....	£695(a)
Industrial Prod. Programmer P9010.....	£795(a)
Industrial Prod. Programmer P9020.....	£995(a)
Industrial Prod. Programmer P9030.....	£1295(a)
GANG OF EIGHT PRODUCTION PROGRAMMER.....	£395(a)

UV ERASERS:

UV1B 6 Eprons.....	£47(b)
UV1T with timer 6 Eprons.....	£59(b)
UV140 14 Eprons.....	£71(b)
UV141 with timer 14 Eprons.....	£88(b)

ALL PRICES EXCLUDE VAT

Please add carriage 50p unless indicated as follows:
(a) £8 (b) £2.50 (c) £1.50 (d) £1.00

We also stock a full range of TTLs CMOS, CPU's, RAMS, EPROMS. Please write for our catalogue.

CONNECTOR SYSTEMS

I D CONNECTORS

	Headers	Receptacles	Edge Conns	Grey Cable/m
10 Way	90p	85p	120p	40p
20 Way	145p	125p	195p	85p
26 Way	175p	150p	240p	120p
34 Way	200p	160p	320p	160p
40 Way	220p	190p	340p	180p
50 Way	235p	200p	390p	200p

RS 232 JUMPER LEADS WITH 25 WAY CONNECTORS

24" Single end Male.....	£5.00
24" Single end Female.....	£5.25
24" Male to Male.....	£8.25
24" Female to Female.....	£9.50
24" Male to Female.....	£9.00

Other lengths available

TEXTTOOL ZIF SOCKETS

24 pin.....	£7.50
28 pin.....	£9
40 pin.....	£12

GENDER CHANGERS

25 Way D type Male to Male.....	£10
Female to Female.....	£10
Male to Female.....	£10

AMPHENOL CONNECTORS

	Solder	IDC
36 Way Centronics Plug.....	500p	475p
36 Way Centronics Socket.....	550p	500p
24 Way IEEE Plug.....	475p	475p
24 Way IEEE Socket.....	500p	500p
PCB Mtg Skt.....		
Ang. Pin 36 Way.....	750p	24 Way 700p

D CONNECTORS

	No of Ways			
	9	15	25	37
Male Solder.....	60p	85p	125p	170p
Angled Pins.....	120p	180p	240p	350p
IDC.....	175p	275p	325p	—
Female Solder.....	90p	130p	195p	290p
Angled Pins.....	160p	210p	290p	440p
IDC.....	195p	325p	375p	—
Hoods.....	90p	95p	100p	120p
Screwlock Hood.....	130p	150p	175p	—

DISC DRIVES

BBC compatible disc drives, fully cased and supplied complete with cables, manual and formatting disc for operation with the BBC micro. These drives can operate in both single and double density modes and are suitable for use with any micro with Shuggart A400 interface. Mechanisms available separately.

Single Drives

1 x 100K 40T SS.....	TS100 £85(b)	With integral psu PS100.....	£120(b)
1 x 400K 80/40T DS.....	TS400 £125(b)	PS400.....	£145(b)

Dual Drives (with integral psu)

Stacked Version PD200 2 x 100K 40T SS.....	£190(a)	Plinth Versions PD200P.....	£215(a)
PD800 2 x 400K 80/40T DS.....	£265(a)	PD800P.....	£289(a)

3M FLOPPY DISCS

Authorised Distributor
Data Recording Products



Industry standard high quality discs with guaranteed error free performance for life.

Discs in packs of 10:

40T SSDD £13(c)	40T DSDD £18(c)
80T SSDD £22(c)	80T DSDD £24(c)
3 1/2" Discs Pack of 10 £38(c)	

MONITORS

All monitors supplied with BBC lead

MICROVITEC 14" RGB	MONOCHROME MONITORS:
1431 Standard Resolution.....	SANYO DM8112CX Hi Res 12" Green Screen.....
1451 Medium Resolution.....	£90(a)
1441 Hi Resolution.....	KAGA KX1201G Hi Res 12" Etched Green Screen.....
	£99(a)
MICROVITEC 14" RGB with PAL & Audio	KAGA KX1202A Hi Res 12" Etched Amber Screen.....
1431 AP Standard Resolution.....	£105(a)
1451 AP Medium Resolution.....	ZENITH 123 Hi Res 12" Green Screen £70(a)
	ZENITH 122 Hi Res 12" Amber Screen £70(a)
KAGA TAXAN 12" RGB	
VISION II Hi Res.....	£225(a)
VISION III Super Hi Res.....	£325(a)

DRIVE ACCESSORIES

FLOPPICLENE Disc Head Cleaning Kit with 20 disposable cleaning discs ensures continued optimum performance of the drives.....	£14.50(c)
Single Disc Cable.....	£6(d)
10 Disc Library Case.....	£1.80(d)
40 Disc Lockable Box.....	£14(c)
Dual Disc Cable.....	£8.50(c)
30 Disc Storage Box.....	£8(c)
100 Disc Lockable Box.....	£19(b)

PRINTER SHARER/BUFFER

A unique printer sharer/buffer that provides a simple way to improve the utilisation of the installed equipment by reducing the waiting time for printing documents.

- * STANDARD Centronics interface with 3 inputs
- * EACH input port scanned every 5 secs to check for data. Switching between ports completely automatic.
- * Data input rate 4800 bytes/sec
- * LED Bargraph indicates percentage memory used.
- * COPY key allows current document to be reprinted.
- * Internal check to prove the data integrity.
- * PAUSE switch allows printing to be stopped temporarily to allow paper change, adjust form feed etc. or allows temporary storage for large number of small files which can all be printed together.
- * RESET allows all buffer memory to be cleared without having to hard break on the computer.

* 64K buffer capacity. * Mains powered * Compact 7cm x 17cm x 24cm
TSB 64 Buffer/Sharer £205(a)
Cable Set £30

PRINTER/COMPUTER SHARERS

Three computers to one printer (Centronics — Cable Set (ea 1m long) £25(d)
26 pin) £65(b) Three computers to one printer (Serial) £75(b)
External power pack £6.50

TECHNOMATIC LTD

MAIL ORDERS TO: 17 BURNLEY ROAD, LONDON NW10 1ED
SHOPS AT: 17 BURNLEY ROAD, LONDON NW10
(Tel: 01-208 1177 (4 lines) Telex: 922800)
305 EDGWARE ROAD, LONDON W2

PLEASE ADD 50p p&p & 15% VAT

(Export: no VAT, p&p at Cost)

Orders from Government Depts. & Colleges etc. welcome.

Minimum Telephone Order £5.

Detailed Price List on request.

Stock items are normally by return of post.



A disk in the lap

Those invaluable lap-top portables that started with the Tandy 100 and followed with the NEC 8201 and the Olivetti M10 now have the one thing they really needed — a disk drive.

The market, says the company which has produced the £200 device, is small. 'As such, it gives us two choices,' says Zeotek. 'To distribute through normal retail channels and see, in consequence, an increase in price by up to 50 per cent, or to market the product by direct mail ourselves.'

It has chosen the latter, and is looking for people who want to distribute the disk inside their companies.

Without having tested it yet, I suspect that it won't work like a true disk system on CP/M micros, simply because it uses a serial RS232 link. That's bound to make it slower than the parallel data highways normally used for disks.

However, for those of us who find the Tandy 100 (or the other versions, all the same design) indispensable, and who aren't prepared to step up to the near £1000 required for next-generation hardware, any disk is better than none. And this one has a rechargeable battery so it can travel with you.

Details on (01) 205 9068, and please, anyone who uses one, feel free to pass on your comments. Just a memo would do.

Dressing up an image

Despite the fact that he is a computer nut and a chartered accountant, I look forward to meeting Brian Garton Jenkins, who has just been elevated to president of the Institute of Chartered Accountants. A meeting is just what the Institute had in mind, no doubt, when it sent me his biographical details.

The man is obviously not content to be pegged into the conventional staid image of accountants or computer industry 'respectables', and is prepared to work hard at avoiding this fate.

'Many will remember how, in the early 1970s, he lectured around the country and in Europe, waving a cheap ladies' dress,' remarked his publicist, Andrew Colquhoun,



At a mere £1300, this little IBM-compatible portable, with disk, is enough to make even the Osborne name seem irrelevant to people who are afraid that the company can't really have recovered from bankruptcy. The machine has been upgraded since this model was first touted (you saw it on the PCW front cover in August 1984), but the original version remains a good bet as a travelling machine if you can afford something better than a Tandy 100.

It's only limitations are the 16-line ICD screen and the fact that it isn't very easy to read in dim lighting. The Mark Two version, of course, has battery backlighting for the display.

But this one does have the ability to plug into an ordinary CRT display, with the full 25-line PC-DOS/MS-DOS display showing.

Prices start at the £1300 already mentioned for the 128k version. A more sensible 256k version with two disks (but no rechargeable battery) costs £1700. With the external display adaptor, plus 512k, the price rises to £5 short of £2000.

By comparison with the 'second generation' versions of the Tandy 100 — well, there is no comparison. The only really serious rival will be the Interquadram Datavue, when the company gets a UK version together. Details from Future Management on (0908) 615274.

somewhat ambiguously.

Assuming that it was the garment, not the wearer, which was cheap, the tale tells of how (in an effort to test computer accounting systems) his staff purchased the item 'in his wife's name', and did not pay.

The accounting system in question proved equal to the task, and the company (assuming Mrs Jenkins to be another light-fingered swindle merchant) sent round the heavies.

Now, if we can get him interested in micros rather than computer audit standards, perhaps the image of the accountancy trade will improve yet again.

Basic translation

The problems of writing in Pascal are made far worse if you're a trained Basic programmer because the two languages don't think alike, so

a translator program, to take your Basic (Applesoft version) programs and rewrite them in Pascal, might not seem optimal.

However, Woodchuck Industries has produced such a translator in the belief that people will be able to sell their software on other machines.

Today, P-Tral costs \$125, and when it is fully debugged (in the autumn) the price will double. Existing customers will be charged an extra \$25 for the bug-free version.

What makes the translator unusual is that while it works on your Applesoft code, it stops and asks you for suggestions when it comes up against problems, so you probably develop some Pascal skills as the thing goes on.

For example, it may request a new variable name if the Basic version isn't acceptable in Pascal.

Woodchuck also claims that your Pascal code will run

around three to 10 times faster than the Basic, using Apple Pascal 1.1.

Details on (212) 924 0576.

To sell or build — that is the question

Olivetti is 25 per cent owned by AT&T, the American phone giant. AT&T owns Unix, and sells a big micro worth £20,000 called the 3B2, while Olivetti sells an IBM PC compatible called the M24.

In exchange for having AT&T sell the M24 in the States (under the title PC6300), Olivetti is now going to sell the 3B2 in Europe.

What is going to slow down the company, I think, is the fact that AT&T owns Unix.

Someone has to decide whether AT&T will make more money from selling an operating system to lots of different Unix systems' builders, or by building systems that use Unix.

The man in charge of selling Unix to UK dealers insists that the 3B2 is a wonderful opportunity for the dealer, and can be used as a Unix machine, or a local area network controller, a file server (or both), and so on. And when the software is all ready and polished and slick, I think he's right.

But AT&T's 'determination to be a force in data processing' could be likened to Intel's determination to be a leading force in microprocessors.

Intel sells the 8086 family, and also builds systems that use the chip. But, very sensibly, it doesn't sell imitation IBM PCs. It does quite well with a pricey range of boards and boxes for people who want to build a system of their own, but who only want a hundred or so (often fewer) for specialist purposes.

Can AT&T really command the Unix hardware market, and sell an exactly similar Unix to rival hardware builders? And can it sell the microprocessor chip — a 32-bit design — that is inside the 3B2?

In the States, the general feeling is that the M24 has flopped. Inside Olivetti, they say that in fact it's done much better than they forecast.

It's true that in Europe, the M24 is looking like the



The theory behind this RAM disk software for the Macintosh is: you don't need all that 512k of memory, so use some of it as an imaginary fast disk.

At \$34, you might think it's cheap enough not to gripe, but I don't. I know that the Mac is unreasonably slow at using its disks, and I also believe that this product is rather more clever than Assimilation Process's Mac Memory Disk in deciding how much memory to sacrifice to the imaginary disk.

But many programs for the Mac use more than half the memory anyway, and you may find that the overall speed increase is roughly what you'd expect for \$34. What we really want is 512k of memory, plugged into the second disk slot. But that would cost . . .

Details on (602) 224 5944 from Symmetry Corporation, which makes its appearance with this announcement. More software, it says, will follow.

number one rival to the original PC. We'll just have to wait and see if AT&T sticks it out in the American hardware business.

A UK Christmas for the new Amstrad

It was Alan Sugar's intention, when he launched the Amstrad micro, to keep temptation away. Temptation, he said, was going to the States with it. 'I won't go there,' he said.

Now he has. Well, sort of. Well, hardly at all, really.

What he's done is to produce a version for the American market which will hardly cost him buckets and buckets. He hasn't set up an American outfit — he's just selling the CPC6128 to Indescomp. That company will charge over \$700 for the machine, which will have one clear advantage over the UK version — CP/M.

You may have read, in the past couple of issues, a warning in this column saying that the CPC664 wasn't anything other than a disk version of the ordinary

Amstrad (normally with tape), but that a proper version was on the way. This, it seems, is it.

The bad news is simple: it is, says Sugar, 'unlikely' that the CPC6128 will appear in the UK this year. There's no reason to believe a word of this. If ships had already left the Far East with stocks of the 6128, they'd be likely to arrive in September, but Alan Sugar would not make any announcements that might stop dealers stocking the 664 in the meantime.

My information is that the ships have indeed already sailed, and a machine capable of running CP/M version 3 will be in the shops in plenty of time for Christmas.

IBM PC Think Tank — more than an editor

It's enthusiasm time again.

This issue of Newsprint comes to you from yet another editor — this time, ThinkTank on the IBM PC. (Well, to be accurate, on the Zenith imitation XT, but that's as near as makes no

difference the same thing.)

This is the nicest thought-organising program I've used. It goes well beyond the Macintosh version of ThinkTank 512 which I raved about recently, because of its colour, its replication, its smart printing abilities, and its data transfer abilities, among many features.

The program is a development of what is called a 'folding editor', but used as Living Videotext uses it, it becomes very much more. Most users never realise that it can be used as a simple editor, using it instead to structure thoughts, plan schedules, organise new routines, and otherwise keep tabs on their organisational life.

As is usual with complex programs, it's almost impossible to describe. Unusually, it's very easy to learn. However, I'll try to give some idea of what version 2.0 on the IBM is like by asking you to compare it with one of those lectures which computer people are always giving.

You may never have sat through a computer expert's tutorial, but if I say that 'it's always a question of drawing boxes and linking them with arrows', perhaps you'll know what I mean.

The normal end-result of such a tutorial session is a

series of words, all over the board, linked with lines like a spider's web overloaded with flies. It's a neat way of explaining things in outlines, but somehow, when you come to look at it all later, you can't remember which box was drawn first, and which others had the arrows coming out of them.

ThinkTank gives you a single word, the outline headline. Type the + sign, and it will expand itself to show the sub-headlines. Move the cursor onto one of those sub-headlines, and you can expand them into sub-sub headlines.

Better than that, however, is the fact that you can also expand them into large explanatory documents.

Take an example — that always makes things easier. Your main headline might be 'Tuesday', a day which involves several complex tasks.

Expand it and you might find your sections: 'Before Work', 'Morning at office', 'Lunch at client XYZ' and 'Afternoon in seminar'.

It doesn't matter in what order you remember them because you can put a headline anywhere and move it anywhere else.

Things that happen nearly identically can be copied. If your presentation over lunch will be much the same as your



For a mere £1000 more than the Osborne Encore, this Data General One, at its recently reduced price of £2241, offers the same single diskette, 128k and liquid crystal display. The extra money is for a full 25-line, tilting display of the same shape as the original IBM PC which the One emulates.

The reduction can be as much as 20 per cent on some models of the DG One, and a 512k system with two diskettes fetches a fat £3850. The good news is that many manufacturers are doing disks for this machine now, but the bad news is that I bet whichever program you actually want, it's only available in Sin IBM disks.

APRICOT WINDFALLS AT MORSE

We've pruned our Apricot prices at Morse, and we now offer stunning discounts across the entire range. Morse are ACT Blue Riband dealers, and we'll give you better support and value than anyone else. Call today!

Apricot PC, 2 315K drives, (RRP £1595): **£1125**

Apricot PC, 2 720K drives, (£1795), now: **£1375**

Apricot Xi, 10Mb, 720K drives, (£2795): **£2030**

Apricot F1, 720K drive, software, (£1090): **£995**

Portable, 720K drive, software, (£1695): **£1390**

Monitors: 9" £200, 12" £250, 10" colour £385



SANYO Superdeals at Morse! Special prices on MBC 550 series mean 16-bit computing for the cost of a home computer! Includes WordStar and others worth over £1000, MSDOS & 128K RAM.

Sanyo MBC 550, Single disk, (RRP £795): **£569**

MBC 555, 2 disks, extra software. (£995): **£749**

MBC 555-2, 2 320K disks, software (£1395): **£945**

Monitors: CRT36 12" £127, CRT70 colour £395

All Morse prices exclusive of VAT at 15%, E. & O.E.



DECMATE II, the famous wordprocessing system, includes system unit, 2 drives, display, software, RRP £3190. Ex display: **1690.00**

Brother EP44 (£249) **199.90**

Casio PB700 (rrp £110) **79.00**

Casio FP200 32K (£299) **215.00**

Casio FX450 Sci (£19.95) **12.95**

Casio PF3000 data (£39) **29.90**

Casio PF8000 touch (£49) **39.95**

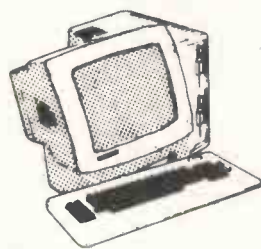

Televideo TS1605, full IBM PC compatible, runs Flight Sim, 1-2-3, Framework. 2 360K drives, 128K memory, (512K for £400 extra), 14" display, RRP £1990 **1290.00**

Epson JX80 7 col. (£569) **540.00**

Epson HI80 plotter (£395) **375.00**

FX80 used, 1 only (£438) **250.00**

PFS Graph IBM (£99) **59.90**

PFS Report IBM (£95) ... **57.50**



LOTUS 1-2-3, the most popular software package in the World is now available in Apricot and IBM formats. RRP now £440: **375.00**

WordStar 3.4 Professional, CorrectStar & Merge (£399) **299.00**

VisiCalc IBM (£195) **115.00**

VisiFile IBM (£219) **145.00**

VisiSchedule IBM (£219) . **145.00**

dB Master IBM (£445) ... **270.00**

MORSE

MORSE COMPUTERS 78 HIGH HOLBORN, LONDON WC1V 6LS. 01-831 0644. TELEX 916509.

introduction for the afternoon seminar, you can copy the one, rename it, and modify it.

For things which are exactly the same, you can 'clone' the outline.

This started out, according to Living Videotext, as a mistake — a 'bug'. The idea was to have identical copies, but not to have them work as clones. Clones (in folklore) are so alike that they all change simultaneously, and so it is with these. If you remember to add a new joke in your presentation to one client, all clones of that outline will now have 'new jokes' in that place. If you delete something, it will disappear from all clones, too.

When they came to fix the bug, all the test users protested that it was the most useful feature in the new version of the program.

Of course, I'm more concerned with planning my output as a journalist than with planning a day's work, but the similarities are strong. The effect is that where your average administrator produces a complex network of things to do, and sub-heads of how to do them, I produce a relatively simple outline — Newsprint in four parts, for example.

To edit the stories, I can use the ThinkTank controls. These involve fairly obvious menu prompts on the bottom of the screen, but you can always type in the control codes direct. To edit a document attached to a headline, for example, you type F10 (to get the menu) ED (for Edit Document). To edit the headline, you'd type EH. If you can't remember that, just tap the space bar until you see the right selection at the bottom, and hit RETURN.

To edit the text, the IBM arrow keys can be used, but there's a big plus — WordStar keys.

These were an addition at my own prompting, so I'm proud of them. I was rabbiting on to David Winer at Living Videotext about how stupid Microsoft and Apple had been to ignore WordStar cursor controls when so many people can do them in their sleep. Winer went all thoughtful, and a couple of months later, when my review copy arrived, his note mentioned that he'd taken the thought seriously. 'You weren't the only one to ask for it,' he added, 'but we hadn't taken it seriously till then.'

The result is that I can get to the top of the document with control-Q, R, and the bottom

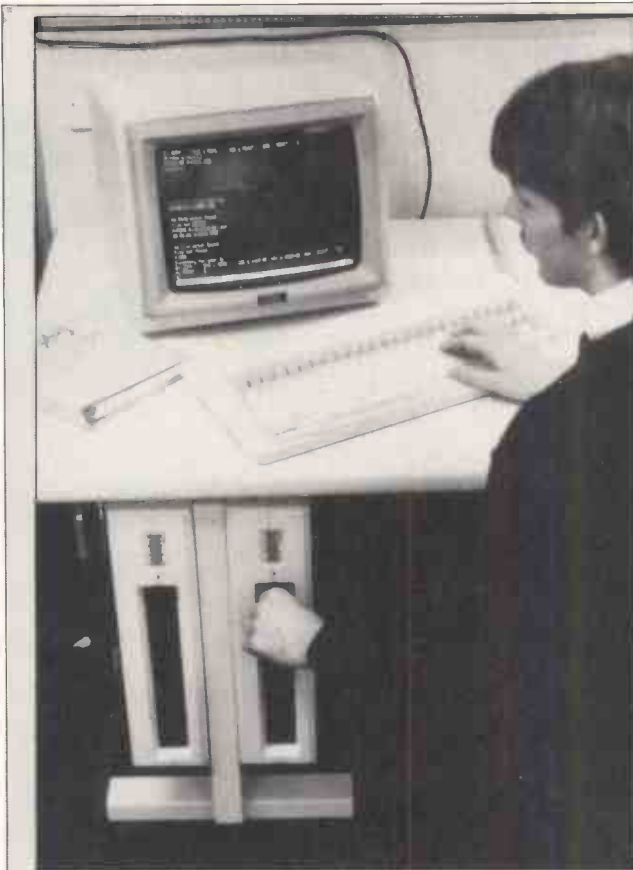

Traditionally, octopi have kept a low profile, and this Octopus from LSI is no exception. Something like 10,000 have been sold, and no-one tells me anything about it.

LSI has now produced this bigger version of the Octopus, again with twin processors giving both eight and 16-bit processing, like the old Rainbow.

I know 10,000 is nothing compared with things like the 'failed' Macintosh with 'only' 200,000 units sold, but by comparison with some UK ventures, it's worth a passing mention. And the company has been around for quite a while.

Details on (04862) 73883.

with control-Q, C. I can delete the next character with control-G, or the next word with control-T — all things I do in my sleep.

If you're not WordStar trained, you tell the program to ignore these keys, and it does.

The use of colour is a definite plus over the Macintosh version: you select your own favourites, and they appear. Text being edited is one colour, text selected is a different colour. An outline shows up in your favourite colour, with all connected sub-headlines in the same shade.

As a word processor, the program lacks only one thing — the ability to format paragraphs to different widths. This hardly matters if you own an ordinary word processing program because ThinkTank will create a text version of any outline and prepare it for your own word

processor — even for WordStar, with 'soft carriage returns' and all the other things.

Within ThinkTank, you can embed control characters to turn on your printer's special features — bold face, underline expanded, condensed, and so on.

Any headline (plus associated document) can be printed, with attached sub-headlines, to whatever depth you chose, or the whole document can be printed.

And when the document is printed out, your recipient will be delighted to find that the date is printed at the top of the page and an index is attached, showing which page (numbered, of course) has each headline, and which are headlines attached to superior headlines.

Finally, I have to put in a word for a very underrated feature — speed.

From the top to the bottom

of quite a large outline takes a split second. From the top of a large document to the end is instant. Going back, also, is instant.

In other words, you can use this program to *read* stuff you've written, as fast as if you were flicking pages in a book.

I wish I could think of something about ThinkTank which I didn't like. Well, I suppose I can. It's the cut-and-paste routine. For example, take the detail about distribution at the end of this story — I got that off my Spotlight index. To get it here, however, I had to get out of this document and create a new headline with the FILES command. Then I had to edit that headline's document and cut it with the selection menu. Then I had to get out of the editor and switch to this headline. Then I had to get the Paste menu and stick it in. Still, it worked.

In the UK, ThinkTank will be handled by Rapid Recall on (0494) 26271; the contact is Andy Kitchener.

Networks everywhere

At last, I have found a local network system which can link all other local area nets together.

It is a system called **Banyan**, launched by a new company, and was one of several really impressive networking announcements at the recent Comdex fair in Atlanta, but on a level of cleverness that isn't matched by any of the others.

A Banyan is a swamp-growing tree which sends out new trunks to hold its wide-spreading branches out of the water, and it looks more like a local area net than anything else you could find.

The network seems able to link any type of computer to any other, and to provide proper file server facilities across the network, not just a shared disk system. Better than that, it can reconcile two completely disparate local nets.

It can link a 'star' network of IBMs to an Ethernet, to a host mainframe, to a token-passing ring-main net or to a Corvus network, using synchronous or asynchronous protocols. It can even support the different file structures of MS-DOS, Unix, Macintosh, minicomputer operating systems, and mainframes.

QUME

'originals'

**Best for the
Qume family
of printers**

Qume ribbons, developed and refined by Qume and made in Britain for use with all Qume Printers here in the U.K. and in Europe.

Why gamble with imitations, when, for a very small premium you can get Qume Originals. The best ribbons for all Qume Printers without a doubt.

Be sure your printer sees "red" when you fit your next Multistrike I, Multistrike II, or Multistrike IV.



Qume[®]
Qume (UK) Limited,

Marketing and Sales
Park Way, Newbury, Berkshire RG13 1EE
Telephone: (0635) 31400 Telex: 846321

Service and Training Centre
Bridgewater Close, Reading, Berkshire RG3 1JT
Telephone: (0734) 584646 Telex: 849706

A British Company of **ITT**



Food for thought if you're about to do your accounts.

A constant diet of sales ledgers, payrolls, stock control, invoicing (and that's just for starters) is almost guaranteed to damage the health of your business.

You'd be far better off concentrating your energies on more profitable pursuits, like driving your business forward.

That's where your not-so-humble servant, the unique Apricot Accountant steps in.

Why 'not-so-humble'? Well, by the time you've finished reading this we believe you'll see that you can't afford to be without it.

FRUITFUL RELATIONSHIPS.

The Apricot Accountant is designed to work either with one Apricot personal computer or in a local network with the entire Apricot range.

Already, we're the most widely used range of business micro's in Great Britain.

A dynamic duo, without doubt.

Apricot Accountant, as you can see to your right, is as easy on the eye as it is to use.

Each slim module or Apricot Dataslate is dedicated to one particular accountancy function: Invoicing, Payroll, Stock Control, Sales Ledger, Purchase Ledger, Nominal Ledger and Data Analysis.

Apricot's Dataslates allow you to build your own compact desktop filing system.

Every slate has its own manual and file to house the 3.5in. micro floppy program disk.

A PLAIN DIET.

All the instructions are written in plain

English. So, if this is your first introduction to computers, Apricot protect you from the verbal fog of computer-speak.

Equally, if your staff aren't fully conversant with accountancy terms, they will more than welcome our plain speaking.

They'll also welcome the release from the drudgery of every-day routine.

Our expertise in accountancy is hardly surprising when you consider that as a company we have been writing accounting software for smaller businesses for 20 years.

Many of our dealers have been selling it for almost as long.

We've even thought about your stationery for use with the Accountant. A specially designed range of invoices, statements, payslips etc. are available from your dealer.

But if you'd rather use your own designs, we can organise that as well.

INTELLIGENT APRICOTS.

The Apricot Accountant is fast, efficient, thorough and clever.

Unlike other software packages it can be tailored to suit your business needs.

If you need analysis of data, for instance, the keyboard brings a speedy automatic answer.

We collate the information you feed in and automatically update the other relevant modules.

Our software complies with all current legislation and should the law change we'll up-date your system.

The system also knows how to keep a secret. Only specific password holders are allowed access to your information.

AN APRICOT CALLED GEORGE?

The Apricot Accountant has a unique, built-in autopilot called George.

(It has to be better than something with a name like a 'double faceted nerd fangler'.)

George carries out certain regular procedures for you, such as producing a weekly stock report.

Switch your Apricot computer onto 'auto-Q', step through the procedure once, give the job a title and next time round George will handle it all for you.

He'll also train new staff by simplifying their role to a few simple keystrokes until they've got the hang of things.

APRICOT'S MAXI MICRO'S.

Whichever Apricot micro you choose you can rest assured you've chosen from the pick of the crop. Not only do we offer the largest compatible range in the world, but they can all be locally networked.

They are also fully capable of interfacing with mini and main-frame computers.

To top that lot, the Apricot software library is the absolute cream. We have the largest, published library in the UK.

And that includes the best-selling business package in the world, Lotus 1-2-3 as well as Symphony, their new all-in-one system for managers and professionals.

All the other famous software names are there also: Micropro, Ashton-Tate, Microsoft, Digital Research and so on...

Finally, for those of you hungry for the latest facts and figures there is nothing to touch Communiqué.

Services such as Prestel and Pergamon Infoline as well as Telecom Gold and Easylink, our telex service, are yours at touch of a button.

Call in on your nearest Apricot dealer so you can get all the facts to chew on.



apricot
ACCOUNTANT



APRICOT Xi 10. 256K RAM, 10MB
WINCHESTER. £2,795*

MicroSight



NIMBUS VISION

A complete image capture system including an 80186 based microcomputer with high resolution graphics, mouse, a high quality vidicon camera and a video digitiser with up to 512 x 512 pixel resolution. Applications include video displays, image analysis, object counting etc. Complete systems from

£2950 + VAT

MICROSIGHT

For connection to a range of microcomputers, MicroSight systems can provide a low cost image capture facility up to 512 x 512 resolution either by scanning or frame grabbing. Packages including camera, interface, software for disk storage, hard copy and display are available for IBM PC, Apricot, Hewlett Packard, BBC Model B etc from

£900 + VAT

MICROEYE

Video interface with 512 x 512 x 8 resolution

£495 + VAT



MicroScale image analysis software to run with MicroSight Systems

- * Particle sizing and Orientation
- * User definable scaling
- * Hard copy and disk file dumping of results
- * Dimensioning
- * User definable windows

Available for IBM PC, AT, XT, RML Nimbus, Hewlett Packard 9816, Apricot, BBC Model B etc from

£950 + VAT

For further details contact:-

DIGITHURST The image analysis people

Digithurst Ltd.

Leaden Hill, Orwell, Royston,

Herts. SG8 5QH

Telephone (0223) 208926

SpeedIt

GENERATE FROM
SPEED IT FROM

```

Swap
  *Swap the two items at Lo
  Temp = Items(Lo)
  Items(Lo) = Items(Hi)
  Items(Hi) = Temp

Shell
  GOSUB SetCount
  Dim Items(Count)
  GOSUB SetData
  Span = Count
  WHILE Span>1
    *Cut the Span width.
    Span = INT(Span/2) : J = 1
    Lim = Count - Span
    WHILE J <= Lim
      Lo = J
      WHILE Lo >= 1
        *Need to interchange?
        Hi = Lo + Span
        IF Items(Lo) > Items(Hi)
          GOSUB Swap
          Lo = Lo - Span
        J = J + 1
      WEND
    J = J + 1
  WEND
  *Print the sorted array
  GOSUB DisplayData

100 'Shell: Procedure
110 'Shell Sort algorithm
120 '
130 GOSUB 560: 'SetCou
140 DIM ITEMS(COUNT)
150 GOSUB 640: 'SetDat
160 SPAN = COUNT
170 WHILE SPAN>1
180   'Cut the Span wi
190   SPAN = INT(SPAN/
200   LIM = COUNT - SP
210   WHILE J <= LIM
220     LO = J
230     WHILE LO >=
240       'Need to
250       HI = LO + SP
260       IF ITEMS
270       GOTO 320
280       'The
290       GOSU
300       LO = LO - SP
310       GOTO 350
320       '$001
330       'E1s
340       LO =
350       '$002
360   WEND
370   J = J + 1
380 WEND
390 WEND
400 'Print the sorted array
410 GOSUB 740: 'DisplayData
  
```

BASIC PROGRAMMERS YOUR REVOLUTION HAS BEGUN ...

The neatest and best program editing system for BASIC programs. Write structured flowcharts on your IBM-PC screen and watch them translate directly into BASIC. One day all programs will be written like this.

Works with almost all BASIC systems including IBM Advanced BASIC. Supplied in MSDOS Format — 5¼" SS Disk. A revolutionary concept with extensive built in help-screen facility for speed and structure.

So — if you're writing a program in BASIC, Speed It to completion.

Minimum Hardware Required: IBM-PC/XT or Equiv. 256KRAM, 1 Floppy disk Drive 5¼", RGB Monitor.

Lamnia, R.H. Jones, 49 Normanton Ave. LONDON SW19 8BA. Please send me :

☐ Full SpeedIt system(3K line progs) £99

☐ Limited system(300 lines of prog.) £29

☐ One Day Conversion Course at The RAC, Pall Mall, London + VAT

Name

Address

..... Postcode

Cheque/Money Order for £..... encl.

Limited stocks at this price. Special concessions for schools, universities and technical colleges.

The company was set up in late 1983 and has had its products under test in the Boston Bank and World Bank, to both of whom it has now sold very large multi-network networks.

The central box on which all this cleverness is based is a Unix-driven micro containing a Motorola 68000.

This is almost the ideal application for a Unix machine: it needs to be served by experienced programmers who can write their stuff in C and pass the job on to the next person.

The box includes an ordinary IBM PC bus, into which IBM network cards can be plugged.

The 'heart of the Virtual Networking Systems (VINES) software', as Banyan puts it, is the Street Talk 'location-independent naming system'. This 'provides an efficient way to identify objects within the network, such as information, applications, peripherals, protocols, or other computing resources distributed throughout single or multiple locations'.

The World Bank system apparently includes 32 Banyan boxes, each linked to each other, and each supporting a complex local network (already extant, in some cases) inside the organisation.

Banyan is contactable at 135 Flanders Road, Westboro, MA 01581, tel: (617) 366 6681.

To Banyan, the announcement by IBM of its PC Networks software was not even a surprise, let alone a challenge. To other micro networkers at Comdex, however, the IBM announcement was the talk of the show.

The pioneering 3Com, for example, which linked up with the Microsoft Networks announcement in late 1984, has now adopted the IBM version (which shares some central assumptions with the Microsoft product) as a 'strategic direction'. The company announced its Macintosh network, EtherMac, at the show, but rushed together a statement talking about 'product strategy' and its intentions to support IBM's 'de facto standard' during this year.

The address for 3Com is 1365 Shorebird Way, Mountain View, CA 94039, tel: (415) 960 9451.

Low cost is the central feature of the **Racore-Net** announcement. The Racore network is unique — it's



This magazine, The Sunday Times and Thames Television may seem like an unlikely bunch of collaborators, but they united as organisers of this year's British Microcomputing Awards. The winners were announced in June, although only products available before the end of January were eligible.

The independent panel of judges included industry figures such as David Fairbairn of the National Computing Centre and Robin Bradbeer, one of the founders of the Association of London Computer Clubs and now managing director of Intergalactic Robots.

ACT won two business awards — one sponsored by Computer People for the Apricot Xi, and the other for Business Micro of the Year with the Portable (one of the three awards PCW sponsored).

Sinclair collected two awards as well — one for its Logo in the educational software category (sponsored by our publishers VNU), and one for the QL as Home Micro of the Year (the second award PCW sponsored).

There was one other double-header, the Icon local area network from Torus Systems. This took the Business Software Award sponsored by Micro Decision, and the Business Software of the Year Award sponsored by the Thames Television programme Database. Psion's bundled QL package won the home version of this Database award.

What Micro? sponsored two categories: the Atari 800XL took its Home Micro Award, while Peripheral of the Year went to the Penman Plotter.

In PCW's third award, for home software, the judges couldn't decide between two packages, so the award was split between Triptych's Entrepreneur and White Lightning from Oasis Software. The games enthusiasts who judged the Game of the Year Award (sponsored by WH Smith) came in with a similar split verdict between Impossible Mission and the Hitch-hiker's Guide to the Galaxy.

Things were more clear-cut in the awards for the Best British Innovation of the Year (which was sponsored by the Sunday Times and went to Oberon's Omni-Reader) and for the Microcomputing Application in Established Industry (sponsored by Barclays Bank and won by Denford Machine Tools).

network hardware put together to run special software. The special software, of course, is IBM's PC Network software, plus PC-DOS 3.1.

The important point, however, is cost: a four-node Racore network should add a total of \$1000 to the four PCs or XTs or ATs, or whatever.

Racore uses token-passing ring architecture, with a two-megabit-per-second data

transfer rate, which is all fairly unexciting — and that's what the company planned.

'It's designed to teach network users the "control-alt-delete" of networking,' said the new company's boss, Rod Crisp, a reference to the way an IBM family machine is reset. 'It uses what will become a new standard of networking, and gives them a chance to start learning their way around it.'

His network controller fits into a long expansion slot in the PC and requires at least 256k, but, frankly, you need twice that for serious PC use. Up to 16 machines can be linked in a cluster, with 250 feet between each node.

Racore is at 10 Victor Square, Scotts Valley, CA 95066, just around the corner from Victor (Sirius), tel: (408) 438 7255.

A more ambitious network, the **ThinkLink** from Tangent Technologies, uses the enormously powerful Motorola 68010 (the bigger brother of the 68000, which in turn is the bigger brother of the Sinclair QL's 68008) to run very fast indeed.

However, Tangent's most impressive contribution to networking is a link between IBM micros and Apple's Macintosh-based AppleTalk.

The main thing about AppleTalk, on IBM micro, is that you (potentially) can use the wonderful Apple LaserWriter printer.

MacBridge not only connects a PC to the printer, but lets several PCs share it, in the same way that AppleTalk lets Macs share it. At the price of a printer that's essential, or no-one would ever buy one.

Even better, Tangent has produced a program to convert WordStar files into Post Script command files so that you can do wonderful things with WordStar. You can even take a WordStar document, instruct Post Script to slant it by 15 per cent, put a box round it, and print it over the top of another document.

Apple is planning a vaguely similar card, but it won't have the Post Script interface.

Tangent is at 5720 Peachtree Parkway, Suite 100, Norcross, Georgia 30092, tel: (404) 662 0366. But there's no panic about this until Apple gets the rocks out of the bag containing the LaserWriter and ships some over here to Europe.

There were many other networking announcements at Comdex, but they all failed to qualify for serious consideration because the people behind them clearly had no prior knowledge of IBM's PC Networks announcement, or even, for that matter, current knowledge. **END**

Guy Kewney can be contacted on electronic mail. His numbers are Source TCK 106, and Telecom Gold 81: JDS018. The Prestel mailbox number is 01-802 2679.

YANKEE DOODLES



Over the Rainbow

After a disastrous foray into the personal computer market with its Rainbow (over-designed, late, not IBM compatible, expensive, poorly distributed), DEC is attempting a powerful comeback — in more ways than one.

Replacing the Microvax I, the company has introduced the Microvax II, a desk-top version of the VAX 11/780, star of DEC's minicomputer line. Base price of the Microvax II is about \$20,000, approximately one-fifth of a full-size VAX. The Microvax II is available as a low-end machine in the 32-bit VAX line and as a network workstation, and will support up to 16 users in a network at a performance level of about 90 per cent of a VAX 11/780.

The Microvax II uses two chips — a 32-bit 78032 microprocessor and a 78132 floating-point unit. The mpu uses pipelined architecture and has four gigabytes of virtual storage space.

Almost more interesting than the Microvax II is the announcement of a 600Mbyte read-only optical disk storage device — the first compact disk system to be marketed commercially.

The price is an attractive \$2195 which includes the disk reader, controller and cables. At this point, DEC has no plans to market the system as a peripheral for other computers. Too bad.

Worms in the Apple

Amid growing dissatisfaction among its independent local retailers, Apple has decided to disband its three-and-a-half year old national accounts sales operation. Lately, the 100-man sales and support

group has mainly been concentrating on trying to sell the Macintosh to large corporations in direct competition with IBM, and has scored some notable successes. But while 20 to 30 per cent of Apple's sales came through this unit, dealers felt betrayed due to their diminished margins and questions about Apple's market intentions following the withdrawal of the Macintosh XL.

Enzo Torresi, senior vice president of the Businessland chain of stores, expressed a common view among dealers. He said: 'Apple has laser technology, a local area network, integrated packages, a database server, and a lot of reasonable, well-done, user-friendly software. But is that sufficient in an IBM-dominated market?'

Apple's success, said Torresi, lies in how well it can motivate the existing dealer channel in presenting an alternative to IBM. 'That's the challenge where DEC, Xerox, TI and Burroughs failed.' With the disbanding of its national accounts program, Apple seems to have heeded these views and has again put its local dealers in the forefront of the market battle.

Also with Apple, the company announced it would kill a program to manufacture 20Mbyte 5 $\frac{1}{4}$ in hard disk drives, and that it would postpone the release date on a Mac file server to the year end as opposed to the October availability promised earlier.

Jean-Louis Gasse, former general manager of Apple France, has been appointed as marketing director of the Macintosh division. He replaces Mike Murray who becomes director of business development, a new post.

Meanwhile, Apple chairman Steve Jobs will spend a month or so in France — on holiday, perhaps?

The second time around

Reorganised and directed by an entirely new management team recruited from Atari and NEC, SpectraVideo recently unveiled a series of CP/M and MS-DOS computers at a New

York press conference.

The event marked the official re-introduction of the company since writing off and restructuring approximately \$2.6 million of past debt, and becoming a majority holding of Bondwell Holding Ltd of Hong Kong. It's the Bondwell name that appears on all the machines, as it does in the UK where Barbitan is the importer.

The company has announced four entries in the CP/M arena. Most interesting is the Bondwell 2, an 11lb lap-top portable with built-in 3 $\frac{1}{2}$ in disk drive, 25-line \times 80-character LCD display, and bundled software from MicroPro. The machine is priced under \$1000 and is marked for September delivery.

Three other CP/M machines fall into the transportable category — the Bondwell 12, 14 and 16, all of which are currently available.

The Bondwell 34 and 36 are MS-DOS machines and are said to be IBM compatible. The 34 has 256k, dual 5 $\frac{1}{4}$ in disk drives and the usual interfaces; price is \$1795. The Bondwell 36 substitutes a 10Mbyte hard disk for one of the floppy drives in the 34, and is priced at \$2995.

'Marketing,' explained John Constantine, president of the new company, 'will be largely locally based because our present dealer network is widely scattered throughout the country.'

To date, no Hong Kong manufacturer has been successful in the US market (except as a second-source OEM supplier). Will SpectraVideo be the exception? Much as I like the company, I would have to say 'not a chance'.

Coming soon

Next month will be my 18th month writing the Yankee Doodles column, and I hope you have all enjoyed it. If you have a comment or if there is something you would like me to cover, please drop me a line at 12 Indian Head Road, Morristown, NJ 07960, US.

In the coming months, I intend to go out on a limb and make some projections on those companies who will and will not make it in the personal computer market —

not only in the US, but worldwide. I'm also going to give you my pick of the 12 worst computers that have ever been unleashed on an unsuspecting public. And if that isn't enough, I'll also make a prediction as to which countries will be most influential by the Year 2000. This is something that almost everyone else did in the magical year of 1984, but now, I'll give you the *real truth*. Stay tuned!

Random bits

In an effort to revive an ill-fated deal with Apple Computer, Cullinet Software has supplied Apple's MIS group with a program to connect Mac computers to Apple's IBM mainframe. Cullinet hopes that Apple executives will use the system and will like it enough to bring it to market . . . Informatics General also has a micro/mainframe link called Micro/Answer Toolkit, through which micros can access IBM mainframe files and databases . . . Data General has upgraded the LCD screen on the Data General One (for the second time), made available a five-slot expansion chassis, and cut prices by 15 per cent in an effort to boost flagging sales . . . Morrow has also upgraded the screen on its Pivot portable to a 25-line unit and dropped the price by \$10000 . . . PC compatible vendors have introduced a tidal wave of new machines in an effort to take advantage of the shortage of IBM PC/AT computers. NCR has introduced the PC8; Compaq, the Deskpro and Portable 286; Zenith, the Z-200; ITT, the Xtra XP; and Corona, the ATP-6-QD . . . Acknowledging that the PC6300 has not sold well, AT&T's James Edwards said: 'We decided that going head-to-head with IBM was stupid.' AT&T's new strategy will focus on communications and local area networks . . . Microsoft has introduced Excel, a spreadsheet for the Macintosh that the company hopes will break Lotus' stranglehold on the spreadsheet market. It is said to have advanced capabilities in size, speed, interactivity, multiple window displays, graphics and formatting. **END**

COMPUTER DISCOUNT STORE

VALUE AND SERVICE



SYSTEM · 1

APRICOT XI

Hard Disk + Free Printer
+ Free Integrated Accounts Software
including Payroll Training & Installation

£2495 + VAT

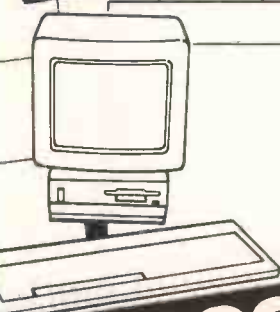

SYSTEM · 3

APRICOT F1

720K Disk 256K Memory
includes Free Integrated Accounts
Software

£895 + VAT

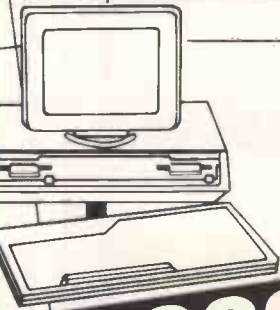

SYSTEM · 5

APRICOT TWIN DISK

+ Free Word Processor
+ Free Printer

ALSO AVAILABLE
720K Drive version
POA

£895 + VAT

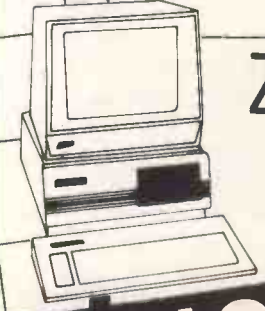

SYSTEM · 7

ZENITH Z150

(IBM Compatible) Twin Floppy + Free
Accounts Software
ALSO AVAILABLE 10 Megabyte Hard Disk
£2845 + VAT

£1645 + VAT

SYSTEM · 2

COMMODORE PC-10

(IBM Compatible)
256K RAM Free
Accounting Suite
including Payroll

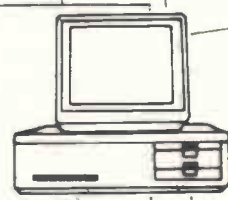

£1395 + VAT

SYSTEM · 4

OLIVETTI M24

Twin Floppy
+ Free Accounts Software

ALSO AVAILABLE
10 Megabyte Hard Disk
£2895 + VAT

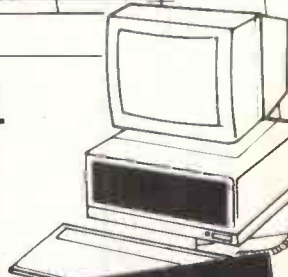

£1645 + VAT

SYSTEM · 6

SPERRY PC

256K RAM, 2x 315K 5¼ inch
drives, plus free accounting
software and free printer.

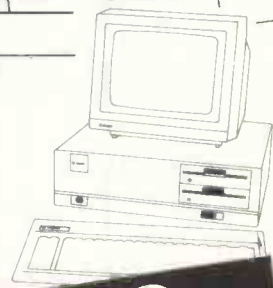

£1890 + VAT

SYSTEM · 8

EVALUATION SYSTEMS

AVAILABLE FROM £100 per week
ALSO AVAILABLE
RENTAL SYSTEMS
FROM
£40 per week

£100 + VAT

COMPUTER DISCOUNT STORE
58 Mount Stuart Square, Cardiff CF1 6DR

Tel: (0222) 488650/488641

APPLE COMPATIBLE PERIPHERALS

NOTCHER disk capacity DOUBLER	£3.99
SATURN 128K RAM CARD for file	£199.00
128K RAM Card with manual & disk	£139.95
SNAPSHOT (II & II+) - Dark Star	£52.00
SNAPSHOT file - Dark Star	£39.95
COPIKIT Software - Dark Star	£19.95
SHUTTLE MULTITASKING Software Dark Star	£19.95
Auto Dial/Answer MODEM Card	£125.00
COMMS software for above	£25.00
PRESTEL Graphics ROM for Modem Card	£19.95
Disk Drive Controller Card	£34.95
13 1/8 Sector Drive controller card	£39.95
16K RAM (language) card	£34.95
80 Column Card (Vixel Compatible) II+ & e	£44.95
80 Col Card as above with Soft Control	£59.95
INVERSE Video ROM for above	£5.00
80x40 Column Hard Switch	£6.95
80 Column Card for file	£44.95
80 Column Card for file with 64K RAM	£84.95
Z80 CP/M Card for II+	£39.95
Z80 PLUS Card for manual for II+	£149.95
CP/M Z80-B (6MHz) Card with 64K RAM II+	£169.95
Z80 Card for file	£44.95
CP/M Module for file	£86.00
Parallel Printer Card (Centronics)	£34.95
Parallel Printer Card (Epson)	£34.95
SUPER Parallel Card with manual	£89.95
Printer Buffer Card (64K dump)	£129.95
Grappier Card	£149.95
Grappier+ 16K Buffer	£149.95
CHAMPION Parallel Interface (with cable)	£45.00
CHAMPION + 16K Buffer (with cable)	£89.00
CHAMPION + 64K Buffer (with cable)	£125.00
CACHEBOX 64K Parallel inline Buffer	£125.00
Communications Card	£32.95
RS-232 Serial Interface Card	£34.95
SUPER Serial card with manual	£89.95
7710 Asynchronous Serial Interface	£79.95
NTSC to PAL Converter + UHF Mod	£44.95
NEW PAL Card with Sound	£49.95
RGB Card (TTL output)	£49.95
RGB Card (LINEAR output)	£49.95
IEEE-488 Controller, cable, disk & manual	£149.95
Epson Blower Card (2716, 2732, 2754)	£49.95
MK2 Epson Blower (2716, 2732, 2754, 27128)	£59.95
NEW EPROM controller/Parallel I/Face	£32.00
EPROM Blower for 2716, 32, 32A, 64, 128, 256	£53.00
PROM Writer card (models 7454, 7452, 7452B)	£169.95
8748 Writer burns 8748, 8749	£149.95
A/D Card 16ch, 0-5 12v, 100 microsecs	£79.95
D/A Card 2ch 8bit, or 1ch 16bit, 0-10v	£99.00
8 BIT AD/DA (8 or 10 bit, 1ch d/a)	£89.95
12 BIT AD/DA (16ch ad, 1ch d/a)	£119.95
CLOCK CARD (TIME II) Card	£44.95
MOUNTAIN Clock card	£179.95
Music Card	£44.95
Wild Card	£69.95
Wild Card Plus	£99.95
Four Port Twin 6222 Card	£119.95
8809 Card	£119.95
Integer Basic Card	£32.95
LOGO Card	£59.95
Joystick (self centring)	£14.95
Joystick (deluxe version)	£19.95
Joystick extension cord	£3.99
Apple Compatible Power Supply 5A	£49.95
ASC II Encoded Keyboard with IC mod	£54.95
IBM STYLE keyboard for Apple	£89.95
A/C Cooling Fan (clip on) with suppress	£24.95
Speech Card	£79.95
Replay Card	£79.95
Form Card	£89.95
8088 Card with 64K (capacity 128K)	£365.00
Light Pen system	£159.95
Graphics Table	£89.00
IMAGE Processor (colour/mono/SSTV use)	£199.00
SATURN/TITAN ACCELERATOR Card II+	£269.00
SATURN/TITAN ACCELERATOR FOR file	£299.00
IC TEST Card T1, T2, T3, T4, T5 (used for mfg)	£119.95
IC TEST CARD D/S/AM, ROM, PROM, EPROM software	£169.95

APPLE STORAGE DEVICES

CUMANA full height drive for Apple	£109.00
CUMANA half height drive for Apple	£145.00
AFD-2 half ht. 5.25/3.5 floppy drive	£249.00
AFD-4 half ht. DS/DD 5.25/3.5 floppy drive	£289.00
AFD-4 drive controller card	£59.00
INTEC 5MB Hard Drive for Apple	£699.00
INTEC 10MB Hard Drive for Apple	£950.00
INTEC 10MB Hard Drive (37cups)	£875.00
510MB Hard Drive Controller Card	£250.00
(Note: All INTEC drives are UK built and backed - Prices include controller card, cables, power supply, utility and diagnostic software for DOS, PASCAL & CP/M, together with 24 month service warranty)	

PRINTERS - DOT MATRIX

NEW LOW PRICES!!!	
ANADEx - 100% DUTY CYCLE	
ALL MODELS	Call
BROTHER	
HR-5 Portable thermal transfer (P or S)	£125
HR-5 for CBM64/VIC 20	£125
EP-44 Thermal transfer (KSR)	£189
M-1009 Dual Interface	£155
M-1009 (IBM) 50cps	£189
2024L NLQ 190cps draft	£339
TC 600 - Typewriter - printer	£149
DISK DRIVE for TC 600	
CANON - NEW LOW PRICES	
PW-1080 160cps (NLQ)	£263
PW-1156 160cps (NLQ)	£349
PJ-1080A Seven COLOUR 37cps	£379
DATAPRODUCTS - PAPER TIGER	
8010 80col 180cps draft NLQ both S & P	£389
8011 as above but IBM COMPATIBLE	£389
8020 132col 180cps draft both S & P	£469
8021 as above but IBM COMPATIBLE	£469
6050 132col 200cps + SSF both S & P	£1219
8050 COLOUR as above but colour printing	£1449
8070 132col 400cps draft LQ both S & P	£1589
8070 COLOUR as above but colour printing	£1829
EPSON	
*NEW LX80 80col 100cps (16cps NLQ)	£206
Tractor for LX80	£19
Sheetfeeder for LX80	£49
FX-80 80col 160cps	£309
FX-100 FT 136col 160cps	£420
LQ-1500 200cps (NLQ) 4 to 16" paper width	£855
EPSON 8143 Serial I/Face OK	£29
EPSON 8145 Serial I/Face 2K buffered	£59
EPSON 8148 Serial I/Face 3K buffered	£65
XON/XOFF Serial I/Face 2K buffer	£85
EPSON-COMMODORE I/Face 2K buffer	£55
EPSON 8165 PET/IEEE 2K I/Face 2K buffer	£65
EPSON PET/IEEE 2K I/Face 2K buffer	£65
EPSON APPLE Card 8132	£29
EPSON APPLE Cable 8231	£29
8K Buffered parallel or serial I/F	£79
16K Buffered parallel or serial I/F	£85
32K Buffered parallel or serial I/F	£125
64K Buffered parallel or serial I/F	£159
HONEYWELL	
ALL MODELS	Call



BUSINESS SYSTEMS LTD
55, MAPLE DRIVE, EAST GRINSTEAD, WEST SUSSEX, RH19 3UR

MANNESMANN TALLY	
MT-80 + 100cps	£179
MT-85 80col, 80cps IBM, (corr. qual 45cps)	£289
MT-86 136col, 180cps, IBM, (corr. qual 45cps)	£369
MT-160 160cps	£395
MT-180 160cps (NLQ)	£545
MT-280 200cps, 132col IBM, (corr. qual 50cps)	£825
MICRO PERIPHERALS	
CPA-80P Parallel 100cps, 80col	£179
CPA-80S Serial version of above	£195
CPA-800 OL version of above	£39.95
CPA-80C Commodore version of above	£195
CPB-80P Parallel IBM COMPAT. 130cps, 80col	£199
CPB-80S As above but Serial	£209
CPB-136 Parallel IBM COMP. 130cps, 136col	£289
MP-165 160cps Parallel	£235
MP-165Q QL version of above	£311
MP-165I IBM version of above	£249
SERIAL Interface for 165 series	£55
NEC	
PINWRITER P2 80col	£349
PINWRITER P3 132col	£479
Parallel interface for P3P2	£39
RS232 Interface for P3P2	£129
IBM PC Interface for P3P2	£99
Sheet Feeder for P3	£289
Tractor Unit for P3	£119
NEWBURY DATA	
HEAVY DUTY	
DRE-8830 Parallel 180cps 132col	£1019
DRE-8840 Parallel 240cps 132col	£1129
DRE-8850 Parallel 240cps 132col	£1175
DRE-8850 Parallel 300LPM	£1959
OKI - MICROLINE	
OKI-82A P&S 120cps 80col	£239
OKI-82A 200cps Parallel	£289
OKI-82P 160cps Parallel	£315
OKI-83A 120cps Parallel	£385
OKI-2350 Parallel line printer	£1492
OKI-2410P 350cps line printer	£1529
PANASONIC	
KX-P1091 120cps NLQ IBM COMPATIBLE	£249
KX-P1092 180cps NLQ, 7K buffer, IBM COMP	£369
RADIX	
10 FT/200cps	£439
RITEMANN	
PLUS - (MX-80 FT compatible) 120cps 80col	£199
BLUE PLUS (FX-80 FT corn) 140cps 80col	£229
II - (FX-80 compatible) 160cps 80col NLQ	£255
15 - (FX-100 compatible) 180cps 136col	£395
NEW FX+ 80col 105cps FRONT LOADING, NLQ, 2K	£224
SEIKOSHA	
GP-100 VIC 50cps	£149
GP-100 Parallel or Serial	£149
GP-500A 50cps	£169
GP-250K 50cps	£199
STAR	
SG-10 (FT) 120cps 80col (50cps NLQ)	£195
SD-10 (FT) 160cps 80col (55cps NLQ)	£259
SR-10 (FT) 200cps 80col (50cps NLQ)	£399
SG-15 (FT) 120cps 136col (50cps NLQ)	£295
SD-15 (FT) 160cps 136col (55cps NLQ)	£399
SR-15 (FT) 200cps 136col (50cps NLQ)	£489
TAXAN	
KP-810 140cps 80col NLQ	£369
KP-910 140cps 156col NLQ	£389
KP-810PC IBM VERSION	£409
KP-810PC IBM VERSION	£409
TEC	
1550 Parallel	£539
1560 Parallel	£539
TOSHIBA - 24 Wire Head	
2100H Parallel 100cps LO	£1339
2100H Serial 100cps (NLQ)	£1259
Auto Sheet Feeder for 2100	£546
Bi-directional Tractor for 2100	£136
P-1340 Pli or Serial, 80col + Graphics	£549
P-1351 Pli or Serial, 136col + Graphics	£999

PRINTERS - DAISY WHEEL

BROTHER	
HR-15 Parallel 20cps	£311
HR-15 Serial 20cps	£349
HR-25 Parallel 25cps	£549
HR-25 Serial 25cps	£599
HR-35 Parallel 35cps	£690
HR-35 Serial	£779
HR-15 Keyboard	£129
HR-15 Sheet Feeder	£179
HR-15 Tractor Feed Unit	£360
HR-25/35 Sheet Feeder	£185
HR-25/35 Tractor Unit	£75
TOWA	
Daisy Junior 14cps 80col, Pli	£199
Daisystep 2000 18cps 132col, Pli	£219
DIABLO	
630-API 40cps	£1529
630-API Sheet Feeders, from	£229
EPSON	
DX-100 Parallel 20cps	£315
JIUKI	
6100 18cps	£297
2200	£645
2100	£245
1160	£168
NEC SPINWRITER	
3510/3015 Ser/Pli/Diablo 35cps	£999
7710/3015 Ser/Pli/Diablo 55cps	£1429
2000 Printer 20cps	£509
Ser/Pli/Diablo I/Face for 2000	£89
8800 Printer	£1299
Ser/Pli/Diablo I/Face for 8800	£99
Accessories for NEC printers	Call
QUER	
11/40 RO (without interface)	£1165
9/45 RO full front panel	£1525
12/23 Letter Pro (S or P) 20cps	£445
9/55 RO full front panel 55cps	£1895
11/55 RO (without interface)	£1359
QUEN DATA/UCHIDA	
Daisy Wheel Parallel 18cps	£215
UCHIDA DAISY WHEEL 20cps parallel	£199
UCHIDA as above Serial version	£239
RICOH	
RP-1200 Parallel/Serial 20cps	£489
RP-1300S Parallel/Serial 30cps	£789
RP-1600S Pli or Ser 8K 60cps	£1300
FLOWTRITE 1600 46K Multi I/Face	£1235
FLOWTRITE 1300 46K Multi I/Face	£1279
Elec/Mech Sheet Feeder RP-1600	£445
Tractor Unit for 1600 Models	£129
SILVER REED	
EXP-400 Parallel 10cps	£219
EXP-400 Serial 10cps	£249
EXP-500 Parallel 16cps	£259
EXP-500 Serial 16cps	£289
EXP-550 Parallel 19cps	£419

EXP-550 Serial 19cps	£455
EXP-770 Parallel 36cps	£559
EXP-770 Serial 36cps	£589
Tractor for 500	£84
Tractor for 550/770	£105
Cut Sheet Feeder for 500	£163
Cut Sheet Feeder for 550/770	£163
8K Buffer for 770	£55
16K Buffer for 770	£95
48K Buffer for 770	£259
TEC STARWRITER	
11040 Parallel 40cps	£830
11055 Parallel 65cps	£1160
48K Buffer for 11055	£445
Tractor for F10 units	£129

PLOTTERS

EPSON H180 Plotter	£349
ASTAR MCP-40 4-Colour 80 Character	£105
ASTAR MCP-80 4-Colour full graphics	£165
SILVER REED EB-50 typewriter plotter	£159
MANNESMANN TALLY Plix 3	£325

COLOUR PRINTERS

SEIKOSHA GP-700A	£345
EPSON JX-80 160cps Text	£469
DIABLO 150C	£799
ANADEx DP-9725B	£1299
CPP-40 4-Colour printer/plotter	£39

MONITORS

SANYO	
DM-2112 40col 15MHz + P31	£63
DM-81 12CX 80col 18MHz + P31	£83
CD-3125 14" Normal Res RGB	£165
CD-3117 14" Medium Res RGB	£275
CD-3115 14" High Res RGB	£379
DMC 7650 IBM/APRICOT Colour Monitor	£319
YAN JEN	
GN-1211 12" Green or Amber 20MHz with tilt & swivel base	£83
ZENITH	
122E 12" 15MHz AMBER	£84
122F 12" 15MHz RGB	£79
Tilt base for above	£8
ZVM-133 13" Colour Hi Res (IBM-PC)	£329
Cable for ZVM-133/IBM-PC	£15
PHILIPS	
7513 12" Green, composite, 20MHz	£69
7502 12" Green, IBM Compatible 20MHz	£94
CT 2007 Monitor TV RF, CVBS, RGB	£199
TAXAN	
KX 1201 G 12" 20MHz, Green, P31 tube	£89
KX 1202 G 12" 20MHz, Green, P39 tube	£99
KX 1212P 12" (IBM) 20MHz, Green P39	£119
MONOCHROME CABLES	
Phone Phone	£3.75
BNCP Phone	£3.75
Video/Printer Commodore 64	£3.75
UHF/Phone	£3.00
INDESIT	
APRICOT display 12" (teige or black)	£159

COMPUTERS

APRICOT	
F	£910
PC 256K + 2 x 315K + Monitor	£1295
PC 256K + 2 x 720K + Monitor	£1529
XI 256K + 10MB + Monitor	£2189
XI 512K + 10MB + Monitor	£2249
XI 512K + 20MB + Monitor	£2945
SANYO	
MBC 550 128K + 1 x 160K + software	£595
MBC 555 128K + 2 x 160K + software	£695
MBC 555-2 as 550 but 360K Drive	£789
MBC 555-2 as 555 but dual 360K dr.	£1125
CRT 36 Hi Res 12" Green Monitor	£1110
CRT 36 Med Res Colour Monitor	£1295
CRT 70 Hi Res Colour Monitor	£419
MBC 232 - RS232 I/Face board	£49
64K RAM Plug In Module	£79
EPSON	
PX-8 Portable Computer	£649
120K RAM Disk for above	£249
PX8 + 120K RAM Disk	£889
OX-10 Basic 1MB + Monitor	£1295
PCs AND COMPATIBLES	
CANON	
A-200M 256K + 2 x 360K drives + mono display MS-DOS, GW-Basic	£1449
A-200S as above but COLOUR	£1549
COMMODORE	
PC-10 256K + 2 x 360K drives + monitor	£1499
PC-20 256K + 1 x 360K + 10MB + monitor	£2439
COMPAQ	
PC-2 256K + 2 x 360K drives	£1689
PLUS Portable	£308
DESKPRO 1	£1725
DESKPRO 2	£2089
DESKPRO 3	£3395
DESKPRO 4	£4525
IBM	
Mono PC 256K + 2 x 360K drives + monitor	£1575
Colour PC 256K + 2 x 360K + monitor	£1845
Mono XT 256K + 1 x 360K + 10MB + monitor	£1310
OLIVETTI	
M24 256K + 2 x 360K drives	£1670
M24 256K + 1 x 360K + 10MB	£2795
M21 256K + 2 x 360K drives	£1580
M21 256K + 2 x 720K drives	£1799
SANYO	
SANYO MBC 775 COLOUR PORTABLE IBM COMPATIBLE 256K RAM + 2 x 320K DRIVES, COLOUR MONITOR + MS-DOS and GW-BASIC	£1749

SOFTWARE

WORDSTAR	
D BASE II	£189
FRIDAY	£129
FRAMEWORK	

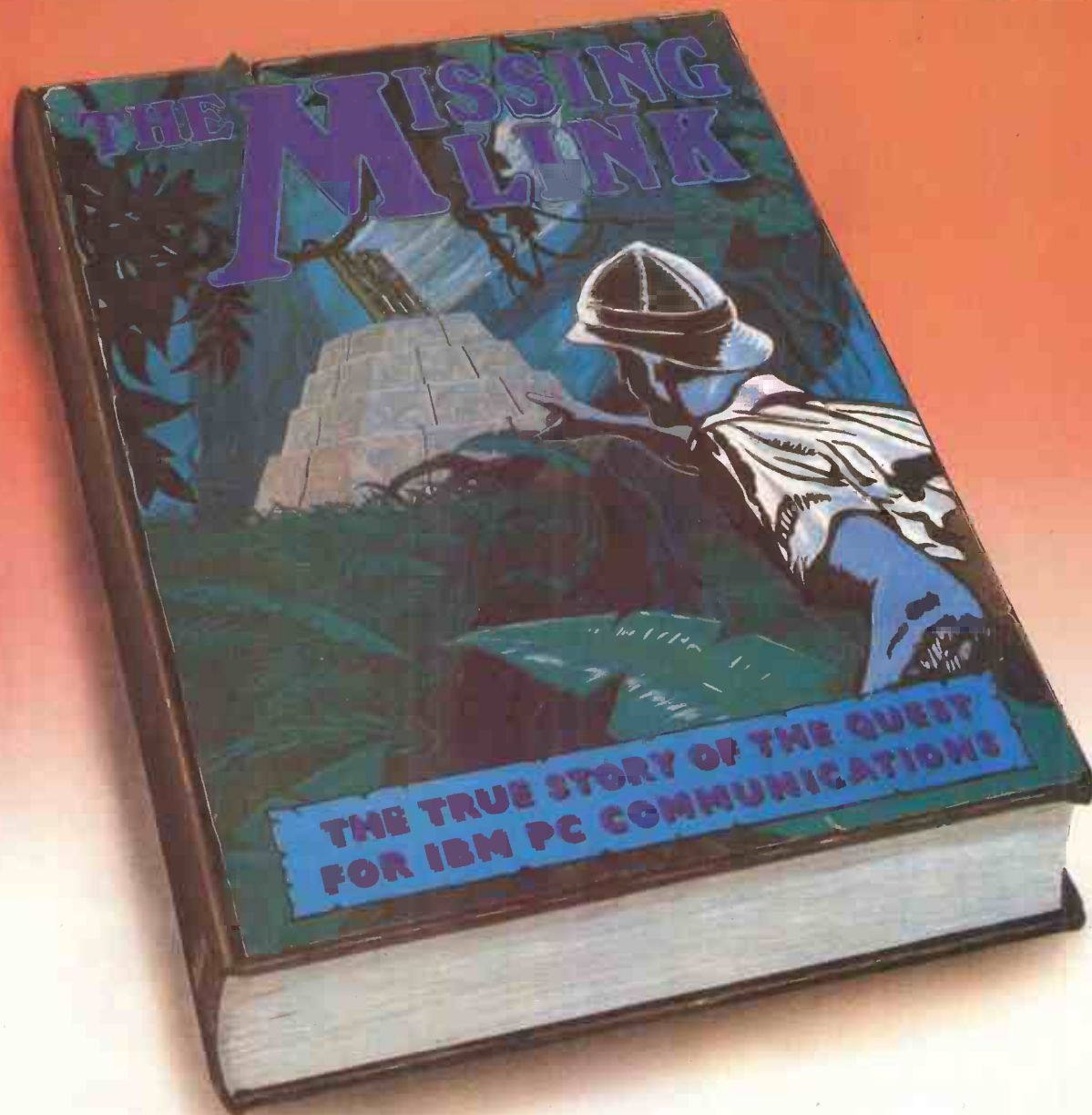

The search is over.

At last, the first complete BABT approved communications package for the IBM® PC, XT, AT, Compaq and compatibles.

The 'Missing Link'* is an internal modem which comes with a menu driven colour software package allowing autodial/ autoanswer access to private and public

VIEWDATA and TELETYPE services such as PRESTEL®, TELECOM GOLD®, P.S.S., ONE TO ONE, and hundreds more.

This British product plugs into any expansion slot and offers V21 300/300, V23 1200/75, 75/1200, Bell 103 full duplex and 1200/1200 half duplex with full error correction. An Asynchronous card is not required.

26 Remote Service details can be held on disk and dialled automatically with full auto logon capabilities. Full Viewdata graphics are displayed WITHOUT replacement chips on the colour card or the need for the IBM Viewdata card.

The Missing Link is available from IBM dealers at a price of £499**+ VAT



For further information contact PC Communications Ltd., Business and Technology Centre, Bessemer Drive, Stevenage, Herts. SG1 2DX

Tel. Stevenage (0438) 316561
Telex 825824

APPROVED for use with telecommunication systems run by British Telecommunications in accordance with the conditions in the instructions for use.

B.T. APPROVAL No. S/1397/3/F/500202

INCLUDES FREE SUBSCRIPTION TO

one to one
Communications for the Computer Age



IBM is a registered trademark of International Business Machines. Prestel and Telecom Gold are trademarks of British Telecommunications.

* P.C. Communications ADM8 internal modem and software

** Pulse Dial Unit



FREE TICKETS

IF YOU SUBSCRIBE NOW

**Subscribe now and we will give you
two free tickets to personal
computing's main event of the year
— The 1985 Personal Computer
World Show.**

Living C-personal™

GIVES LIFE TO C PROGRAMMING

Living C™ is the fully integrated interactive programming environment for C. By replacing the headaches of programming in C with total control and understanding - whether new to C or an expert - Living C is the exciting solution to maximise your creativity and productivity.

£99

The Living C editor is a true full function commercial editor, fully menu-driven with help facilities on call. The editor is fully integrated and can be used at all times throughout the design, development, maintenance and debugging of your C application.

FULL SCREEN EDITOR

Living C allows you to execute all your C source code on the screen. You control the code you wish to examine and the speed of executing. The cursor demonstrates exactly how your source is or prototype works - or why it doesn't!

ANIMATING C INTERPRETER™

Living C conforms to the full Kernighan and Ritchie standard. Living C not only highlights all errors discovered, but also offers comprehensive error diagnostics and useful hints to solve the problem. Corrections can be made immediately, using the fully integrated Living C editor.

FULL C SOURCE DEBUG

The Living C windows allow you to constantly monitor the variables and I/O of your applications even when you are "zooming" to your next breakpoint!

WINDOWS

I understand that I can write my applications in Living C, but what if I want to debug or modify an existing application - bearing in mind that 75% of my programming time is taken up with maintenance?

You simply compile in your C source and leave the rest to Living C! Living C not only enables you to understand how your

application works but also ensures you can interpret a colleague's application and understand why it works or doesn't!! Once in Living C, the full suite of programming tools are automatically available. Combined with your rapid increase in productivity and understanding, you will now find that maintenance time is dramatically reduced.

So now I have written and tested my application, how can I use it?

You have 3 choices:

- (i) Simply switch off the animation and use Living C as an interpreter
- (ii) Recompile your application into your favourite C compiler (eg Microsoft, Lattice, Computer Innovations, Aztec)
- (iii) Use the optional Living C code generator (£99)

What machines does Living C - Personal run on?

Living C - Personal is available for the IBM PC and all compatibles. You will need PC-DOS, either twin floppy disk drives or a floppy and a hard disk with 192K RAM.

How do I order Living C - Personal?

Just fill out the coupon and send it to us along with £99 or call us on **01-948 5166** or **01-948 8166**

Perception Software Systems Ltd., London House, 243-253 Lower Mortlake Road, Richmond, Surrey TW9 2LL
Telex: 946240 CWEASY ref. 19004106

Living C, Living C - Personal and Animating C Interpreter are trade marks of Living Software

Post to Perception Software Systems Ltd., London House, 243-253 Lower Mortlake Road, Richmond, Surrey TW9 2LL

Please send _____ Quantity
Living C - Personal @ £99 x _____
Code Generator @ £99 x _____
Postage & Packing _____
VAT _____
TOTAL _____

To order your copy of Living C - Personal please complete this form

Name _____ Address _____ Telephone _____
£ _____ £ 5.00
£ _____ £ _____
£ _____

Payment Access Cheque
Credit Card expiry date _____
Name on Card _____
Card No. _____

Living C - Personal is available for PC-DOS with min 192KB RAM

LETTERS

*This is the chance to air your views — send your letters to
Communications, Personal Computer World, 32-34
Broadwick St, London W1A 2HG. Please be as brief as
possible and add 'not for publication' if your letter is to be
kept private.*



Calculating the mean

In the December 1984 issue of *PCW*, you published a review of an ISO Pascal package for the BBC Micro.

Some of your readers may be interested to know that an ISO package is also available for the OS-9 based Dragon 64 micro. The language follows the ISO level zero spec very closely and, as in the case of the BBC, includes a large number of (optional) enhancements. Fig 1 shows a Pascal Benchmark comparison between the Dragon and other micros which you have recently reviewed (notice how the Dragon and the BBC Micro are both penalised for their full 9.5 significant digit calculating accuracy in all maths functions).

The geometric mean, which I consider to be the only meaningful way of 'averaging' Benchmarks, summarises the results for each of the six micros listed. Clearly there is nothing to choose, in terms of speed, between the BBC or Dragon p-Code interpreters. OS9 Pascal does, however, include

a native code translator which offers a very considerable increase in speed.

On the subject of Benchmarks, I feel I have to criticise your habit of printing the arithmetic mean at the end of your Benchmark tests. This value, in my view, imparts no useful information at all. As GT Childs pointed out (Letters, April), the geometric mean provides a more precise and meaningful summary of the eight Benchmarks, although even this figure could be misleading as it includes the controversial Benchmark 8.

Basic09, the Basic of the 6809, is a case in point. If this compiled Basic which runs on the OS9-based Dragon 64 (and Tandy Colour Computer) were to be included in your list of 68 computer systems (January issue), it would take twelfth place. However, taking its geometric mean of 3.08 seconds, it would rise to no less than second place with the Macintosh not far behind at 4.85 seconds (fourth place).
Jason Shouler, Poole, Dorset

Calculating the mean remains a bone of contention; it's better to work out which functions you're most interested in and then compare those. And don't lose sight of the fact that while the Benchmark figures are instructive, there's more to using a micro than the speeds they measure.

Special software

PCW readers may be

interested to know that Bardsoft (funded by Sinclair Research) contains information on a wide range of software for special needs, covering 40 micros including the Spectrum, the BBC, Apple and Commodore. This information is located by using keywords — descriptors. For the time being, printouts will mainly centre around 10 main descriptors, which are: Assessment Communication Recreation Numeracy Training/Therapy Cognition Employment Teaching Perception/Motor General

Searches can also be carried out on request for software for specific makes of micros, input switches, goals, and so on. There is a minimum charge of £1, with each subsequent record costing an additional 10p. All prices include postage and packing.

As we are continually updating and expanding the database, we would welcome information on relevant software. In return, we can help to publicise the information worldwide. We have found that some early learning and primary programs are suitable for inclusion.

For further details, contact: HPRU, Newcastle upon Tyne Polytechnic, Newcastle NE7 7TW, tel: (0632) 358211.
Peter Curran, Project Assistant, Handicapped Persons Research Unit

you like Nigel Searle to suggest that you had spelt the word 'computer' wrong when you hadn't?

Nigel had not spelt his name wrong in the signature, but wrote it in a manner that to any half-competent graphologist would show many positive traits.

The fact that the letter 'e' looks like an 'i' shows mental keenness and agility. The fact that the 'i' is dotted ahead of its stem, so in this case it looked as though it was over the 'e', shows keenness and enthusiasm, as does the generally rising lines of his signature. Other indications, such as the open tops to his letters 'g' and 'a', show openness and generosity with his emotions, and the way he writes the capital letter 'N' shows pride and sensitivity. However, on the negative side, there are signs that he blows his top fairly easily!

I hope this will clear up confusion in anyone's mind, and I would be happy to analyse your handwriting one day!

Brian A Watling, Belvedere, Kent

Thanks for the offer, but we'll stick to appearing purely in print for the time being. However, any readers with signature samples from the famous should rush to send them in.

All power to Amstrad

I have something to say to Amstrad — congratulations. Not for making it through the Christmas period, but for truly understanding your field.

Of the millions of micros sold worldwide, none has been worthy of the name 'home micro'. The millions sold have gone into the hands of hobbyists, gamesters and other vertical users' groups.

Not one computer manufacturer, until Amstrad, knew what a home computer should be like. Try explaining to someone how useful a Spectrum will be for keeping recipes or friends' phone numbers and addresses. They may be convinced at first, but

Taking it seriously

Perhaps you could ask the compiler of April's ChipChat to stick to computing subjects and not try to comment on other fields of expertise. I am referring to the comments regarding Nigel Searle's signature (*PCW*, April, page 296). While I am sure that many readers found it amusing, it showed total ignorance of a very serious matter. After all, how would

PASCAL BENCHMARK	Dragon	BBC	Apple	QL	Dragon	Spectrum	Amstrad
	ISO	ISO	USDD	PCode	Native	Native	Native
magnifier	4.98	2.48	6.48	1.88	8.38	8.85	2.95
repeatloop	56.98	119.78	63.38	48.18	3.38	7.88	38.58
whileloop	71.68	128.88	78.98	45.18	4.88	8.98	33.88
forloop	58.98	29.68	74.38	11.88	5.88	7.18	29.58
literalassign	71.48	52.38	88.58	22.88	6.18	7.58	38.58
memoryaccess	72.88	53.18	91.88	28.78	6.48	7.88	38.48
unequalif	97.38	185.28	115.38	48.58	7.98	18.68	33.48
equalif	99.38	185.68	116.78	42.58	8.18	18.68	33.58
noparameters	33.68	38.78	58.28	15.38	11.28	6.58	18.68
reference	36.38	34.88	55.38	17.58	12.88	7.28	19.48
value	36.38	37.98	54.48	18.78	12.28	7.28	19.58
realalgebra	48.48	58.38	83.48	37.98	36.78	21.48	28.88
realarithmetic	62.78	61.28	93.88	43.88	58.88	28.78	19.98
vector	171.38	282.18	283.38	77.58	51.78	17.88	48.58
maths	332.48	346.18	66.88	18.28	321.28	9.38	9.88

Fig 1

waiting for the cassette to load will put them off after the first go.

The Spectrum and Commodore 64 might be too slow, so tell them to buy a Beeb with a disk drive, a monitor and ROM software. You might as well pay the money for an IBM PC or a compatible.

Only now is it possible to utilise the power of a computer at home, now that the Amstrad 664 is here. The most important feature of a computer is speed, but that, however, is let down on cassette systems. It seems to have taken ages for someone to figure out that a disk drive was needed to make use of, and be an excuse for using a computer.

For £450, you can now have a usable home/office/school/games computer, thanks to Amstrad.

One thing is nagging me, however. Why did Amstrad choose a 'non-standard' 3in disk system? The 3½in has proved more popular and is the shape of things to come. I hope the company rectifies this soon.

Samer Shuli, Abu Shabi, UEA

This is a totally unconfirmed rumour, you understand, but we hear that Amstrad could get a much better deal on 3in drives than 3½in. And while we're less than keen on tapes and agree that the 664 is good value, we're not too happy to see the Americans getting CP/M version 3 first on the 6128. Still, if you accept that business must be business, then that's what Amstrad's good at.

Working out the winners

I read with interest the article in *PCW* June on blackjack ('Beating the system'). It surprises me that the author can have overlooked in his discussion two sources of information, one on each of the topics which he covers, although to be fair neither is particularly well known.

The whole topic of random number generation is dealt with comprehensively in a paper in the *SIAM Review* in the late 1960's or early 1970's. If my memory serves me correctly, the substance of it is that multiplicative congruential methods of the form:

$X_{(n+1)} = [(X_{(n)} * a) + c] \text{ mod } m$
provide the longest period provided that the constants a and c are appropriately chosen, usually by ensuring

that they are relatively prime to each other and to m. The simplest way seems to be to ensure that they are both prime numbers.

His second oversight is rather more serious. RA Epstein in *The Theory of Gambling and Statistical Logic*, published by Academic Press, 1977, devotes considerable space to an analysis of blackjack in which he estimates that under various conditions, a positive expectancy of up to about 13 per cent is attainable and I can do no better than to refer interested readers to this.

PR Wilkins, Camberley, Surrey

The easy way

In your May and July Letters pages, there are 'simple' formulae for Fahrenheit/Centigrade conversion and vice versa. For many years, I have used an even simpler conversion which seems adequate for non-scientific purposes.

To convert degrees Centigrade to Fahrenheit, double the Centigrade figure and add 30 to the result.

To convert degrees Fahrenheit to Centigrade, subtract 30 and halve the result.

Elizabeth White, MD, Newcastle upon Tyne

Calling all LEX users

I was very interested to read the article in the June issue of *PCW* on the use of macros in the Spellbinder word processing program. I use a program called LEX-11 on a VAX 11/750, which would seem to have similar abilities. To standard word processing features such as mailmerge and boilerplating it adds calculation facilities, column moving, a database, and keystroke storage of common phrases. However, the most interesting feature of LEX-11 is its ability to store any series of keystrokes an operator might perform, by means of a system of 'visible equivalents'. So macros can be written to perform applications such as invoicing.

I am a beginner in this area, but I have set up an invoice application, and (just for fun) a simple wages program 'translated' directly from one written in Basic by a colleague. These macros use the calculator facility, but there are many other

applications involving text alone: for example, storing a letterheading that automatically prints the current date.

I would like to take this opportunity to ask whether any other users are interested in LEX's programming facility, and if so, whether they would like to contact me via *PCW*. I don't know whether there is a LEX user group. If there is, I should like to join it. If there isn't, perhaps we might start one.

Chrys Bayev, Hull

Stolen property

Our offices were burgled during the weekend of 8/9 June 1985, and among the items taken was an Apple Macintosh computer. Could you bring the serial number of the computer to the attention of your readers in case anyone chances upon it?

The serial number of the Mac is FG2110GM001 (it is a standard 128k Mac). An Apricot with two single-sided floppies was also taken.

We are offering a substantial reward for information which leads to the return of the machines and the conviction of the thieves. If you have any information which may be helpful, please write or telephone (01) 437 4343. **Duncan Scot, Popular Computing Weekly, 12/13 Little Newport Street, London WC2H 7PP**

A fighting spirit

I am a Tamil from Sri Lanka, now living in India as a refugee after the ethnic troubles that erupted in July 1983.

I lost most of my

possessions during the violence, but my Apple IIe computer with two disk drives and my Epson FX-80 printer which were installed in my office were saved. The vandals who ransacked my house destroyed my Z80 CP/M card and the 64k/80-column card, which I had bought only a week prior to the riots, along with most of my applications software manuals.

After 40 days of living in fear, I flew to Madras with my wife and our four children. Sympathetic friends in Airlanka and at the Customs helped me to send my computer system by air cargo to Madras.

I am now living in India in the southern-most part of Tamilnadu. After all the hardships and after having lost virtually everything I possessed, I have now dedicated myself to teaching computer programming to poor people.

I would be very pleased to get in touch with any serious Apple users among your readers.

TV Antony Raj, Tamilnadu

Just in case there's any problems, we haven't published the full address — any letters will be forwarded.

Sale or return

I am a sales assistant in a big computer shop in Ipswich, and I was curious about the 25 percentage of returns rumoured on Sinclair machines, because out of all the returns we get, the majority of them are for Acorn machines and that is allowing for the fact that we sell more of them than any other micro.

I have done my own survey of most of the shops in Ipswich and have come up



**Go for the Best,
Regardless of Cost
EVEN IF IT'S CHEAPER**



**7,000
in Service
Worldwide**



(for
Dealers
Only)

**4.77 MHz
and
7.00 MHz!**

English
German
French
Italian
Spanish
Chinese
Russian
Keyboards

Standard System Features:

- 256K Memory - Expandable to 640K right on Main PCB! Superior Memory reliability at 7.0 MHz
- Real Time Clock with Battery Back-up and Driver Software
- 1 Serial Port (COM1) with Optional (install Chips & Cable) Second Serial Port (COM2)
- 1 Parallel Port (LPT1)
- Game Port
- Floppy Controller for up to 4 Drives
- Two 360K 1/2 Height Panasonic (Shugart) Drives
- 140 Watt XT type Power Supply (This System IS Hard Disk ready!)
- Monochrome Display Adaptor
- 12" Hi-Resolution Amber/Green CRT (TTL)
- 84 Key IBM™ style, Capacitance, 100 million character Keyboard
- Expansion from 256K to 640K Only DM400.00
- One Year Warranty on all Parts

System Options



Color Graphics Adaptor

Supports two levels of graphics and text in monochrome or color. Low resolution 320 x 200 pixel, high resolution 640 x 200 pixel BOA-6200-00



Hi-Resolution Mono Graphics

This Hercules type board will run 1-2-3 software with a true full screen, high resolution of 720h x 348v pixels BOA-6150-00



Hard Disk Controller

Handles 5 to 140 megabytes with minimum software configuration. Features DOS 1.1 & 2.0 compatibility, and ST-506 Interface. BOA-8050-00



Hard Disk Drives

10 Meg DRI-4200-00 40 Meg DRI-6630-00
20 Meg DRI-4265-00 105 Meg (D,E,F) DRI-4250-00
26 Meg DRI-6625-00 140 Meg (D,E,F,G) DRI-4270-00



10 Meg Tape back-up

Inexpensive, reliable, on-board micro-processor that supports streaming or file-oriented. Uses Floppy Controller as Drive C DRI-8080-00

**Micro
Products
International**

**Call: Cynthia Clark
(020) 45 26 50**

Building 70, 4th Floor
1117ZH Schiphol-East
The Netherlands

Fax: (020) 41 81 29 Telex: 18306 TODAY!

**Go for the Best,
Regardless of Cost
EVEN IF IT'S CHEAPER**



**Dual
processor
speed
4.77 MHz
and
7.00 MHz**

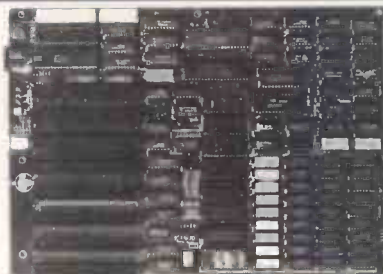

**The
most
advanced
Mother
Board
available!**

- 640K (64K 640K selectable) RAM on-board w/parity check
- Hi-speed (7MHz!) 8088-2 CPU micro-processor w/8087 math co-processor optional
- 8K TURBO BIOS
- Full 640K RAM (maximum XT memory map RAM address) capacity
- IBM PC pinpoint compatible power connector
- 8 channel interrupt 8259
- 8 I/O slot XT standard
- 4 layer PC.B. 2 rows of 256K RAM chips 2 rows of 64K RAM chips
- Same dimensions as IBM XT motherboard
- Full IBM XT compatibility
- 4 channel DMA 8237-5

System Components



Add-On Power Supply

IBM Hard Disk replacement type, 140 Watt, New High Velocity Whlisper Fan, will easily run 2 Floppys, Hard Disk and Tape Back-up POW-1040-00



IBM Selectric Style Keyboards

These quiet alternative Selectric type keyboards will bring the features you have been wanting to a price you can't resist KEY-1051-00



5 or 8 Slot Cabinets

Grey/Beige, enamel finish, perfect fit for IBM PC or XT compatibles, all mounting hardware
5 Slot CAB-3065-00 8 Slot CAB-3068-00



PROM Laser by XOR

Hi-speed algorithms will burn 2716, 2732, 2732A, 2764 (in 52 sec), 27128, 27256 EPROMS under software control right in your PC BOA-8640-00



Super 12 PAK Multifunction

Features Parallel Port, Serial Port, Game Port, Clock/Calendar, Expand to 384K, all cables, PrintSpooler and RAM Disk Software BOA-6335-00



7 PAK Multifunction

Features Floppy Controller, Parallel Port, Serial Port (optional 2nd Serial), Game Port, Clock/Calendar, RAMdisk, PrintSpooler BOA-6250-00



Color Graphics Adaptor

Supports two levels of graphics and text in monochrome or color. Low resolution 320 x 200 pixel, high resolution 640 x 200 pixel BOA-6200-00



Hi-Resolution Mono Graphics

This Hercules type board will run 1-2-3 software with a true full screen, high resolution of 720h x 348v pixels BOA-6150-00



Hard Disk Controller

Handles 5 to 140 megabytes with minimum software configuration. Features DOS 1.1 & 2.0 compatibility, and ST-506 Interface BOA-8050-00



Hard Disk Drives

10 Meg DRI-4200-00 40 Meg DRI-6630-00
20 Meg DRI-4265-00 105 Meg (D,E,F) DRI-4250-00
26 Meg DRI-6625-00 140 Meg (D,E,F,G) DRI-4270-00



10 Meg Tape Back-Up

Inexpensive, reliable, on-board micro-processor that supports streaming or file-oriented. Uses Floppy Controller as Drive C DRI-8080-00

**Micro
Products
International**

**Call: Cynthia Clark
(020) 45 26 50**

Building 70, 4th Floor
1117ZH Schiphol-East
The Netherlands

Fax: (020) 41 81 29 Telex: 18306 TODAY!

LETTERS

with the following results:
Acorn 12 per cent
Sinclair 15 per cent
Amstrad 9 per cent
Atari 10 per cent

Now that is different to the last poll, isn't it?
Andrew Thomas, Ipswich

Communications correction

I read with interest the news story on page 110 of the June issue of PCW, and would like to correct a point raised regarding our communications capabilities.

Communications to Prestel, bulletin boards, Telecom Gold, and so on, is available via two pieces of currently available software:

- 1) Communications with Viewdata, available from ourselves or Kuma, rrp £39.95p.
- 2) Intext, available from Talbot Computers, rrp £113.85p.

To transfer data from one machine to another, an extremely easy-to-use piece of software is Hex-In Hex-Out, available from Crystal Research, rrp £50.

David Bell, AIDPM, software projects manager, Tatung (UK)

Architecture abounds

I am a student of architecture at Sheffield University. I am very interested in architectural applications for personal computers, and would like to contact any other architecture students or architects with similar interests with a view to sharing ideas, programs and tips.

I have a BBC Micro system and have written a program

for simple 3D (perspective) modelling of buildings on this system, and also have experience with larger systems on mini-computers.

If anyone is interested please contact me.
BC Bowden, 4 Whirlowdale Crescent, Millhouses, Sheffield S7 2NA.

We've also had a letter from Derek Burdekin of Slavedrive Software, 'a company set up by an architect to research into the whole business of architects and computers, and to promote the use of computers in architectural design'. Slavedrive's address is 19 Newlay Lane, Bramley, Leeds, tel: (0532) 560687.

Back by any other name

As software director of Multi Media Bureau of Language Enterprises, I believe I can offer some advice to Adrian Taylor (April Letters, page 117) on the delicate issue of language marketing. My company has to date published in excess of 200 languages, including over 40 computer languages. Our publications included five versions of English commissioned by Japanese manufacturers for producing technical manuals, versions of Pascal, Ada, Babbage and Pollock, variations on Bach, a Double Dutch, and all-Greek.

The problem with this type of software is that, once published, a language becomes public property, liable to be used or misused, abused and confused by anyone without the slightest obligation to the original designer. I'm afraid that no publisher will be able to guarantee your reader that his name will be preserved for posterity. A few language designers have been lucky — Chaucer with his English

readily springs to mind — but unfortunately most sink into oblivion. Even if Mr Taylor's Back makes it to fame and glory, he himself may remain a Mr Nobody — a great anymouse of computer science. The only way round this is for Mr Taylor to rename his Back Taylor, or Adrian, like Pascal did with Wirth, Fortran with Backus and Ada with herself.

Before Mr Taylor submits his Back to a publisher (and we at MMBLE will be more than happy to have a good look at it) he must carefully consider the following points: 1) Is it portable? That is, can he carry it all the way to the publishers' offices, or will they have to come over themselves? Will the users be able to carry it home? Will it crash their computers (this has been known to happen with languages which are not portable)?

2) Is it safe and user friendly? From Mr Taylor's descriptions I'd say the language is alarmingly dangerous — a 'steel spike on the top casing' is definitely against the country's safest regulations, especially as this language will be implemented on home computers. I suggest Mr Taylor redesigns this aspect of the language. I'm sure he can put the spike somewhere lower down his Back where it is not so readily accessible. 3) Does it support four-letter words? Most programmers like to have a good sprinkling of these when everything else fails, words such as GOTO and OFFF. Also, are the error messages meaningful, explicit, elaborate and uninhibited?

It isn't possible to go into more detail here, but perhaps Mr Taylor would like to give us a call in the near future and we'll be able to discuss matters in more depth. In the meantime, we at MMBLE wish Mr Taylor the best of luck, and may he be remembered in the annals of computing as the man who gave his Back to the public.
Andrew L Gol, Software Director, MMBLE

Was that your implementation of Double Dutch we saw the other day, or one that's passed into the public domain?

Office automation research

Could any of your readers help me with research for a TV programme? The programme is planned to investigate the ways in which office automation is changing people's jobs.

I am interested in hearing from people who have found their working lives changed — for good or bad — by the introduction of new technology into their office.

The programme will look at every area of office work, including secretarial and clerical workers, managers and professionals. All replies will be treated in strictest confidence and should be sent to me at the address below.

Lucie Hill, 27 Swinton Street, London WC1X 9NW END

BLUDNERS

In June's Program File we missed the end of line 9140 in Alpha. The line should read as published, but with the addition of :ENDPROC at the end.

And going back to May, we've been told by HM Customs and Excise that using the 'M-Basic VAT Accounting' program will result in an incorrect VAT

liability', and that 'the method does not fulfil the legal requirements of Retail Scheme D... Advice on the correct operation of the scheme should be obtained from local VAT offices'. It was an accountant who checked the program for us, but we don't feel up to disagreeing with the VAT people.



'This is my son. He's going to be big in computers'



Bit wars

Big does not necessarily mean best: Martin Banks sounds a warning note on the advent of 32-bit processors.

They're right, of course, all those technology people. They would be, wouldn't they; after all, they invented it in the first place. Why have one, or even eight, when you can have 16 or 32 of them to play with?

Everyone wants 32, if only because the technology people have told them so forcefully that such a quota is necessary. It's just a little *passé* to have only 16 of them now, isn't it? So many of the common herd have got that many, so going for 32 at least marks one out as someone special, a connoisseur of things numeric and digital.

Those who have just eight to play with are, well, beyond the pale. They're the people who do it at home, behind closed doors, and generally only have, you know . . . small ones.

Yet there is a school of thought which suggests that 32 is brain-numbing, 16 is an overkill and eight is just enough for the majority of users, and they shouldn't be conned into wanting more by deceptive advertising and technological hype.

Before you ask the obvious question, I'll give you the answer — I'm talking about bits. Bits, you see, are all-important in this technological age, but I'm beginning to wonder whether there are too many of them and if we actually need them.

What prompted this train of thought was an article in an American electronics magazine which gave advance details of Intel's new 808386 microprocessor. This, for those who don't know, is a 32-bit device. What immediately struck me as strange was the fact that the company has barely got its existing 16-bit processor chips, the 80186 and 80286, out onto the market in anything like quantity, and half the world is still wondering what on earth to do with them.

Intel released the information because getting any new chip designed and into new systems and equipment is a long job. The designs for the next generation of personal computers are already under way. These machines are likely to be, whether we like it not, 32-bit machines, so the design engineers need to know what types of processor are going to be available and what their

capabilities will be.

Intel has found it necessary to make its declarations as soon as possible because others, notably Motorola and National Semiconductor, already have 32-bit processors in the marketplace. These are now gaining design approval among users, and the Motorola device in particular could be a major threat to Intel's dominant position in the personal computer business.

The 68000 family has already made inroads at both the top and bottom ends of the market, scoring as a good engine for Unix-based systems and as the heart of the new generation of home/professional machines such as the QL and the Atari 520ST. The 32-bit version, the 68020, could, in theory at least, prove to be quite a threat to Intel's position, if only because its software compatibility across the whole product range means that computers aimed at very disparate market sectors can offer similar facilities. This in turn will provide users and manufacturers with a theoretical development path that incorporates considerable integrity and continuity.

All this begs an interesting and possibly significant question: do we really need 32-bit personal computers?

The short answer is 'yes', although there is a considerable caveat that should be attached to such a response. The answer is 'yes' for technological and applications-oriented reasons. Technologically, 32-bit devices offer the chance to work at much faster processing speeds. Instead of handling data a byte or two at a time, it can be taken in great lumps and chewed up in one go. This can be an advantage, especially when number-crunching or processing graphics, although for many textual applications it may not be too beneficial.

Such a device also provides the opportunity to gain access to a much bigger memory space within the system, (this is only the case if the processor has a large number of address lines as well as data lines). Large memories are a crucial factor in current personal computer design. They allow the new range of applications software and human interfaces to

be run, which in turn means that more people will want to buy a system. These interfaces, such as Digital Research's GEM and Microsoft's Windows, provide a comprehensive graphics front-end for the applications programs which makes the programs easier to understand and use by the non-computer literate.

But (and this is the first of two warnings I want to attach to the affirmation of 32-bit systems), do the applications most PC users work with really need 32 bits? The graphics bits can be clever, and if designed right they can be very useful, but does the application actually need 32 bits.

I would contend that many users can get by quite happily with eight-bit machines, even in a work environment that includes word processing, spreadsheeting and communications work. Let's remember in this context that the Intel 8088 at the heart of the IBM PC is not a 16-bit processor, but an eight-bit device with ideas above its station.

The second caveat repeats a subject I covered here in June, namely, different ways of constructing computer systems. As has been pointed out many times before, the standard Von Neumann computer architecture has served us well, but is now outliving its usefulness. A central, single processor that is not only responsible for doing the prime job of processing data but also all the necessary housekeeping tasks will always be limited in its functional capabilities and power by the burden of its extra duties.

The typical solution to date has been to make the central processor ever bigger and more powerful in the hope that it will be able to keep pace. What normally happens, however, is that the housekeeping overheads increase as a function of Parkinson's Law. A good example of this is the current trend towards complex graphics facilities on applications programs, and the way they demand and get memory and processing power.

If Sinclair ever gets the money and starts making the waferscale circuits of Ivor Catt, perhaps this cycle will be broken. Robert Maxwell might represent the turning point. **END**

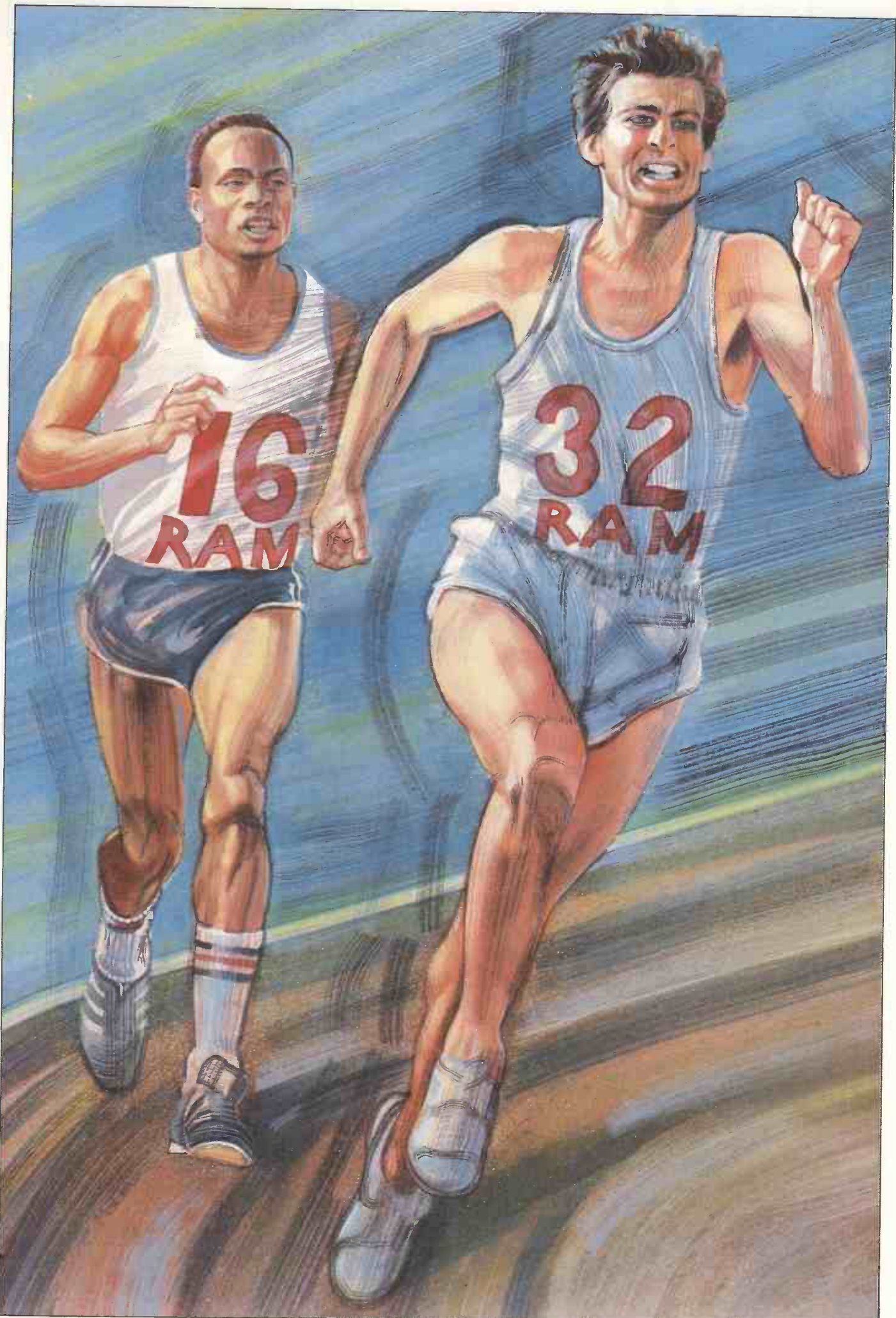

Illustration by Janet Good

Commodore Amiga

Come the revolution, there's going to be the definitive micro—low-cost, multi-tasking and the last word in business computing. Commodore's Amiga may be it. Guy Kewney conveys his very favourable impressions.





The front panel showing 3 1/2in disk drive and expansion slot

I'm sure I'm in for a terrible disappointment with the Amiga, because no computer could quite live up to the effect this one has already had on me. Nonetheless, I've used it; I've asked all the questions I can think of, and on every count, it seems to be the machine I've been waiting for for the past two years, and which the industry stolidly refused to produce.

It does multi-tasking. It has colour. It uses a mouse and icons. It's fast. It has plenty of memory. It has cheap, large capacity disks. And it costs around \$1200 (in the US) without display but including one disk.

It has to be admitted, right at the start, that I wouldn't have been given the chance to assess this micro if I hadn't been conspicuously excited about the early rumours of what I had heard.

Commodore executives kept the publicity lid tight closed on this really new machine, and they succeeded to an amazing degree. As little as a month

ago, many people who you would expect to know about background information were still passing around wholly stupid rumours. And getting official information, which I had to have, wasn't easy.

In the end, officialdom and I played a funny little game in which the company would reveal a little more, and I'd make more excited squeaks of enthusiasm, and the company would open up a bit more, and I'd get more excited, until we agreed that, given my obviously positive attitude towards the Amiga, Commodore would be silly not to give me access to the machine.

That said, I'm sure this really *is* the micro I've been waiting two years for the world to produce. This is the business machine which any games programmer would give his eye-teeth to get hold of. This is the games machine which business software writers will be able to really make hum. And this is the machine which users will

really love.

The Amiga is a multi-tasking micro (it can run several programs at once). It runs them very, very fast. It has graphics animation in colour, not just high-resolution pictures. It has sound capabilities the match of most synthesisers — it is Fairlight data compatible (if that means nothing to you, read on). It can have more useful memory than anyone will plug in for a couple of years, and it will be expandable.

And, to cap it all, it isn't expensive. It runs nearly 10 times as fast as the Macintosh for less than half the price.

All we have to do now is wait for the software to roll in. I expect it to do so, but I have to add that other people are more cautious about software developers' plans.

Hardware

The Amiga is an icon micro like the Macintosh, with a colour display, mouse and keyboard.



The Amiga has a full-travel keyboard suitable for fast typing



The back panel showing I/O ports

The white system box is neat and compact, standing on four 2in-high feet. The top of the unit is 4.75ins above the table, making the unit a thin 2.75ins high. It goes back 13 inches, and the width from left to right is 17.5ins.

The keyboard is separate and includes cursor keys. It's a quality, full-travel keyboard, suitable for reasonably fast typing.

The mouse plugs into the main unit (the same socket can take two joysticks) and is a mechanical device, not an optical mouse. It has two buttons to save elbow grease. For anyone who has used a Macintosh, it will be sufficient to say that you use one button to pull down a menu, and then the other button to select various options, without letting the menu go. You don't have to pull it down five times to change five settings.

The 800k Sony-style (3½in) floppy disk drive is built in, another can be

plugged in, and two more attached if they have their own power supplies. There is a memory expansion slot in the front to take 256k, bringing memory up to a 512k total, and the back panel includes all the standard slits and sockets with almost all of them capable of doing more than you would expect.

As it stands today it is expandable through a large interface slot, with options including a video frame grabber, a hard disk and extra memory. However, there is one special expansion feature planned for 'before Christmas', and that is a 5¼in disk for around \$500 or less, including IBM PC emulation. This is actually done in software.

The display can be one of a range of Commodore devices, or a wide range of alternatives. Commodore's own top-of-the-range screen has very high resolution (640x400 pixels) and will sell for over \$300 (and be well worth it), but cheaper ones will work. It will even

drive a television. Video-out can be RGB, RGBI (TTL level, IBM style), and there is also 'video-in'.

The processor is a Motorola 68000 running at 8MHz. Don't make any assumptions about performance based on that fact, because you'll be wrong. You'll be ignoring the work done by three specialised chips — Daphne, Agnus and Portia, but here's a bit of background first before I go into those processors in detail.

In many respects, there isn't an ideal processor for tomorrow's micro — not if it has to be 'symmetrical' and also 'protected'. But worse, even if you could find a safe micro like the Intel 80286, which is very well suited for multi-tasking, and fit it with the Motorola 68000's nice, regular 32-bit registers, it would still have a simple problem: it would be arranged for data processing, not computing.

Computing involves lots of time-



The side panel has joystick and mouse ports

THE CASH TRADER

The DEFINITIVE program for the cash based business

**** MINIMUM EFFORT ****

Single entry of Takings, Bankings and Purchase Invoices

GIVES

**** MAXIMUM INFORMATION ****

Weekly analysis of transactions.

Receipts and stock purchases both analysed over 20 headings.

Three bank accounts with individual and consolidated reports.

Year to date summaries of income and expenditure.

Unpaid purchase invoices, by supplier and payment due date, showing settlement discounts.

Trading Profit and Loss reports for current VAT period and year to date.

All retail VAT schemes (A-J), monthly or quarterly, including annual adjustments.

Two extra VAT rates can be activated to cover possible future legislation

For further details please contact your local dealer or:-



AEGIS Sales & Marketing

**40/42 BORROWELL
KEGWORTH
Nr. DERBY DE7 2FP**

Telephone: 05097 2976

Supermicro Computers Ltd.

11/15 BUSH HOUSE, BUSH FAIR, HARLOW
ESSEX CM18 6NS TEL: (0279) 416000



HARDWARE	£
APRICOT PC/256K RAM, TWIN 315K DISKS	1,270
APRICOT PC/256K RAM, DUO 720K DISKS.....	1,430
APRICOT Xi 10 – 256K RAM, 10MB WINCHESTER	2,230
APRICOT Xi 10S/512K RAM, 10MB WINCHESTER	2,630
APRICOT Xi 20/512K RAM, 20MB WINCHESTER	3,950

12" Monochrome monitors £165

ACCOUNTING SOFTWARE – PEGASUS
AND SAGE AVAILABLE FROM £300.00

ALSO AVAILABLE: SPERRY – IBM PC's
ALL PRICES EXCLUSIVE OF VAT + CARRIAGE

CASH/CHEQUE WITH ORDER OR
ACCESS/DINERS CLUB.



SOFTWARE	£
EASYWRITER.....	115
MAILMERGE	140
MULTIMATE (IBM PC).....	295
SPELLSTAR.....	130
WORDSTAR	225
WORDSTAR PROFESSIONAL (IBM PC)	270
WORDSTAR 2000.....	300
CALCSTAR.....	110
MULTIPLAN Ms Dos	155
SUPERCALC II	150
SUPERCALC III (IBM PC).....	205
CARDBOX	160
D BASE II	240
D BASE III	350
FRIDAY.....	145
INFOSTAR.....	215
SYMPHONY (IBM PC)	455
FRAMEWORK	325
LOTUS 1-2-3.....	325

wasting processes that have nothing to do with the processing of data. One of the most important of these is displaying enough information for the user to know what's going on. Daphne, Agnus and Portia handle most of this work, leaving the central 68000 to get on with its processing.

Daphne does display animation and sprites, Agnus does animation graphics, and Portia is a peripheral scheduler and interrupt handler which also takes a lot of the disk control work.

These three chips have a shared access to the Amiga's memory. One of the most important functions they have is that of 'bit blitter', an idea which (like icons and the mouse) came out of Xerox's Palo Alto Research Centre (PARC) in California.

It's hard to explain a bit blitter's performance, except to say that it's fast. One software producer working on it tried to compare its speed with other machines, in terms of pixels changed per second. He said: 'If you say that the Sinclair QL can alter 60,000 pixels per second, you'll find that the Macintosh can run around twice that speed, with 110,000 pixels per second. But the Amiga's blitter takes a microsecond to perform any function, at a million pixels per second — and altering a single pixel is just one of its many functions.'

A 'blitter' is bit-map image manipulator, a device which copies one large chunk of memory into another chunk of memory. While it is operating it doesn't block the memory from the processor, and the processor doesn't get in its way as they both have direct memory access through a multiplexer. The system clock makes sure that first the blitter, then the system components, can have access to the memory on alternate pulses.

Stripped of all this explanation, it means that the Amiga can draw a complex shape, fill it with colour and move it to a different place on the screen while changing its shape — and do it faster than your eye can see, at many times a second.

And all this time, your own Basic program can be running uninterrupted, at full speed, sorting through a database. And a complex tune can be played on dustbin lids, all in perfect tune.

Incidentally, no-one has been able to tell me anything definitive about the naming of the chips. Beyond the fact that some people call Portia, Paula, and some call Daphne, Denise.

Portia (Paula) also handles the disk control for floppy disks, which does mean that you have to be careful, when writing programs, not to tie the blitter up for too long if you want to read large amounts of data into the system and *vice versa* — don't tie up the disk for too long if you expect to run graphics.

Agnus includes the 'bit image man-

ipulator', or bimer, or blitter.

Most of its work, besides that, involves making sure that it knows which bit of the system memory it is using. It has 8Mbytes to choose from, including the 512k at the low end of memory, used for the screen.

But it also has some parts of the graphics control: it has the memory logic for the sprites, including vertical position compare logic; and it also has the light-pen registers and the video sync counters.

Although much of the control logic for floppy disks is handled by Portia, the blitter is used for transferring disk data from disk buffers to program and data storage in memory.

The designers were talked into adding another feature to Agnus which was not in the text books: the ability to draw lines. They had the registers on the chip, said one of the team, so why not put line-draw logic in, too? They did, and it draws lines faster than the Pluto graphics machine can — without interrupting the 68000 for an instant.

Daphne is the chip which controls colour, most of the sprite information and most of the 'bit-plane' control. There are five bit-planes (plus a sixth, which is very complex to use and very powerful) on which sprites are handled.

The sixth bit-plane is a 'hold and modify' plane which controls the colour of the electron beam as it scans from

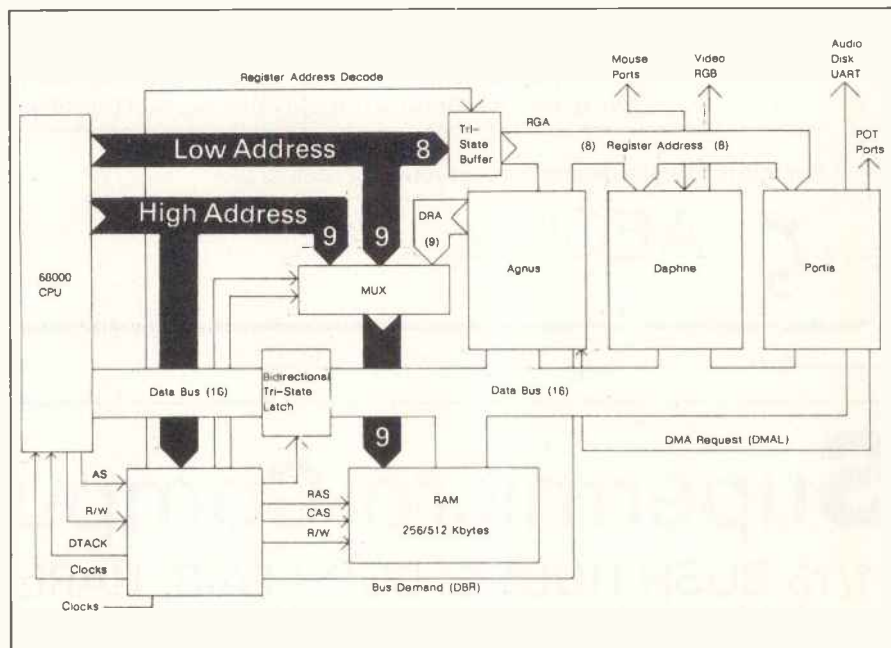

Fig 1 Lorraine

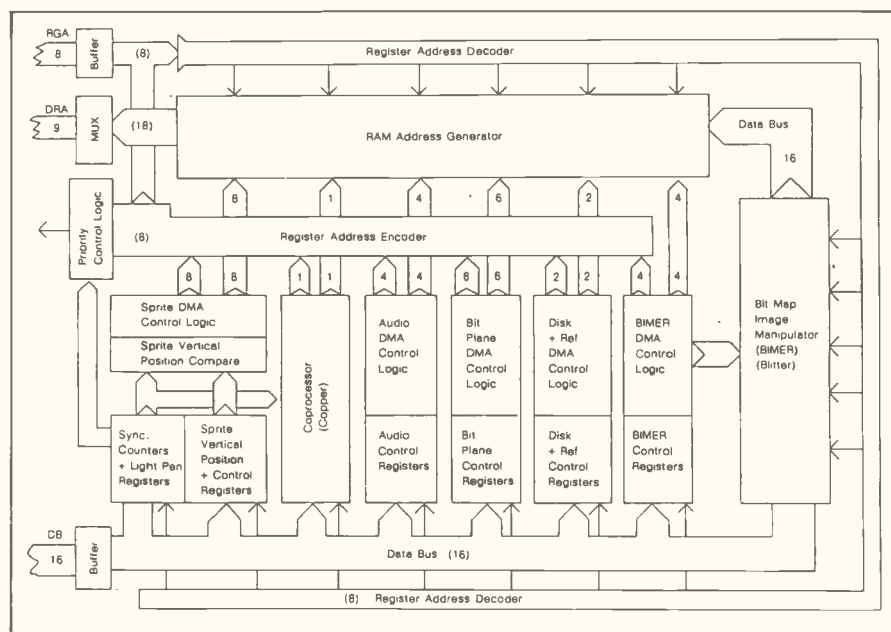

Fig 2 Agnus

OVER 220 AMSTRAD CASSETTE TITLES IN STOCK

OVER 90 NOW AVAILABLE ON DISK
CPM SOFTWARE

Macro 80, Microsoft Basic, Microsoft Basic Compiler, Turbo Pascal, BBC Basic (Z80), Purchase Ledger, Payroll, Database, other titles on request.

● TAPE TO DISC TRANSFERS ●

HARDWARE

Printers, Speech Synthesisers, CPC464 3" Disc, Timatic 5 1/4" 2nd Disc Drive also available.

RS232 INTERFACES INCLUDE

Sideways Rom's, Optional upgrades to BBC Compatible User port. Also available Arnors Maxam Assembler and Quma's Assembler.

664 IN STOCK

Mail order welcome. Please send sae for full list to:

TIMATIC SYSTEMS LTD

Registered Office:

NEWGATE LANE
FAREHAM, HANTS PO14 1AN
Tel: FAREHAM (0329) 239953

Sales and Repairs:

FAREHAM MARKET
FAREHAM, HANTS
Tel: FAREHAM (0329) 236727



Mill Hill Computer Centre SPECIAL OFFER

Home and personal computers, software, peripherals, printers, disc drives and books at unbeatable prices.

All prices include VAT

A wide range of educational software and games always in stock

BBC (B) + free recorder + lead	£325
BBC (DFS) + free recorder + lead	£420
Electron + free recorder + plus 1	£185
Commodore 64 + recorder + joystick QII	£220
Commodore 16 starter pack + joystick	£100
Amstrad + £100 worth of s/w	M. £225
Amstrad + £100 worth of s/w	C. £330
ZX Spectrum 48K + £50s/w	£110
Juki 6100 daisywheel	£365
Daisystep 2000	£235
Cannon PW 1080A	£330
Shinwa CP80	£190
Shinwa CPA80	£230
Commodore MPS801	£190
Microvitec CVB	£199
Commodore H: res (col. monitor)	£220
Philips (green)	£85
Philips (amber)	£95
Cumana 100k disk drive	£125
Commodore 1541 disk drive	£190
Sanyo cassette recorder	£23
Acorn cassette recorder	£32
Floppy disc (45-80 track)	£18

This is only a small selection of what we can offer

For further details either write or telephone us

Mail Order Despatched within 10 days after receipt of your order and cheque
Add £2.50 P&P for orders below £150, and over. £8 P&P

Government & Educational discount given
Export enquiries welcome

RAMCO
ELECTRONICS U.K.

123 The Broadway
Mill Hill, London NW7 3TG
Tel: 01-906 3363

CUT OUT AND KEEP FOR FUTURE REFERENCE

'REPAIRCOVER'

MEANS

LOW COST REPAIRS

WITH

SPEEDY RESPONSE

- Significant **SAVINGS** compared to maintenance costs.
- **RESPONSE** within 24 hours from selected nationwide repairers.
- **HALSEY & COMPANY** have built up a strong relationship with 'Computer People' since 1981 with our exclusive insurance schemes including '**DATACOVER**'. Now the full advantages of '**DATACOVER**' are combined with 'repair response' under '**REPAIRCOVER**'.
- "All Risks" cover (including fire & theft) plus additional expenditure (e.g. data recovery cost) is included.
- The cost of '**REPAIRCOVER**' depends upon details of your system, location etc.

Contact us, or your dealer, for your '**REPAIRCOVER**' quotation.

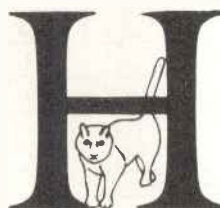

HALSEY & COMPANY
7 Passage Road,
Westbury-on-Trym,
Bristol BS9 3HN
Telephone (0272) 503716

'The Insurance Brokers for Computer People'

side to side in the video display. Using this bit-plane, it's possible to have something like 1000 colours onscreen simultaneously.

There are two types of sprite — the Vsprites and the Bobs. Daphne controls Vsprites. These are 'virtual' sprites, which are always 16 bits wide and as high as you care to specify. They move fast because they are in hardware, but there are restrictions on their use.

For really complex animation, the Bobs (blitter objects) come into their own. These are slower than Vsprites, but give more colour and more options on shape and size.

The power of these Vsprites and Bobs can be gauged from the fact that Amiga includes, in the Basic manual, a few lines of code that make King Kong snatch at an aeroplane buzzing him on top of his skyscraper, and Fay Wray jump out of his hands into a cockpit... and that's the simple animation potential.

There are other types of graphic elements (GELs) concerned with animation. They are beyond the scope of this review (and of this reviewer's comprehension, frankly) but I can say that they will allow transformations of the sort seen in TV commercials, where a word gradually changes shape to become a razor or a motor car, or an office block...

I did my best to understand how many sprites and bobs you can have, and in the end found that every restriction was meaningless. For example, you might think that you can have only eight sprites because there are eight sprite processors. But the sprite processors are the things that *draw* the sprites and not the things that keep track of them — and furthermore, that's only the limit per horizontal scan line! On the next line, you can have eight more as long as they don't interfere with each other. And if you are prepared to calculate what they look like going past each other, that doesn't matter,

either.

You can always decide that you want other sprites there, but you just don't want the sprite processor to draw them in for the moment. Nevertheless, software will keep track of where they are and report their collisions.

Combined with the bit-plane manipulation ability and the management of different screen formats, plus the fact that there are 'rasters' bigger than the display and 'viewpoints' smaller than the rasters, it makes working out the limitations very difficult.

'The limitation is the size of video

... on every count, it seems to be the machine I've been waiting for, for the past two years ...'

memory,' said one developer. 'That's restricted to half a megabyte.'

I suppose, in 10 years' time, that will possibly seem restrictive, but not to a world which regards the BBC's 32k of screen memory as extravagant.

In addition to handling floppy disks, the third chip, Portia, is also concerned with sound. Theoretically there are only four sound channels. In fact, it's almost infinite because the sound channels produce a waveform, not a frequency.

The sound generation of Portia is similar to that of the Fairlight synthesiser. It stores a digitised waveform in a section of memory, and each (stereo) sound channel plays that waveform back.

But it can also transform the waveform. It is possible, therefore, to get a digitised 'recording' of some sound or other, and process it, as the Fairlight does, to produce a whole scale of several octaves. The sound can be a trumpet, a clarinet, any instrument, or an orchestra, a choir, an organ with all the stops out, a dog barking, a bell, or

anything with a definable pitch.

The chip takes that note and deduces all the others from it: you can hear a piccolo playing below the 16ft organ pipe, or a double bass playing at the upper limits of music, or a series of dustbin lids making beautiful harmony with the scratch of perfectly tuned tyres.

Speech synthesis is provided with this sound capability, and two ways of producing speech are offered. There is a pair of pre-recorded voices with American accents, male and female, which will turn text to speech. It's quite clever and, with software, can be persuaded to do realistic things such as raise and lower inflection as sentences are constructed.

Alternatively, there are phonemes. These are sufficient to generate almost any form of human speech from Russian to Xosa with quite convincing realism, but this does take more effort on the programmer's part.

The Amiga's expansion connector allows you to attach anything you like to the data and address lines of the multiplexer, up to a total of 8Mbytes. The system itself uses the other 8Mbytes of theoretical address space, but in such a way that it wouldn't be possible to have 8Mbytes of ROM. Several of the address lines are used directly for chip control.

Products to be launched with the machine are already under development. The obvious ones are extra disks (to plug in the floppy disk expansion port) and extra memory (to go on the expansion port).

Tecmar, the IBM peripheral add-on specialist, is apparently planning to launch a 20Mbyte hard disk which includes two megabytes of RAM, plus a real-time, battery-backed clock and a couple of other odds and ends for around \$1000.

A genlock device is to be released by Commodore to read video signals in off video disk, or tape, or any video source, and match the sync of that video with the video display-out.

Apparently, this feature (automatic sync) is sophisticated enough on the bare micro: programmers report watching football on the display screen on which they're developing software (to the obvious detriment of the software project).

The genlock allows tilting of video frames, overlay, underlay and joint animation, along the lines of arcade games where a cartoon strip background plays and computer animated characters move around, blanking out the background. This is all done in hardware on the Amiga.

One other feature which the blitter makes possible is a RAM disk. Normally this isn't quite the advantage it might seem, because although a RAM disk is faster than a floppy disk (or a hard disk)

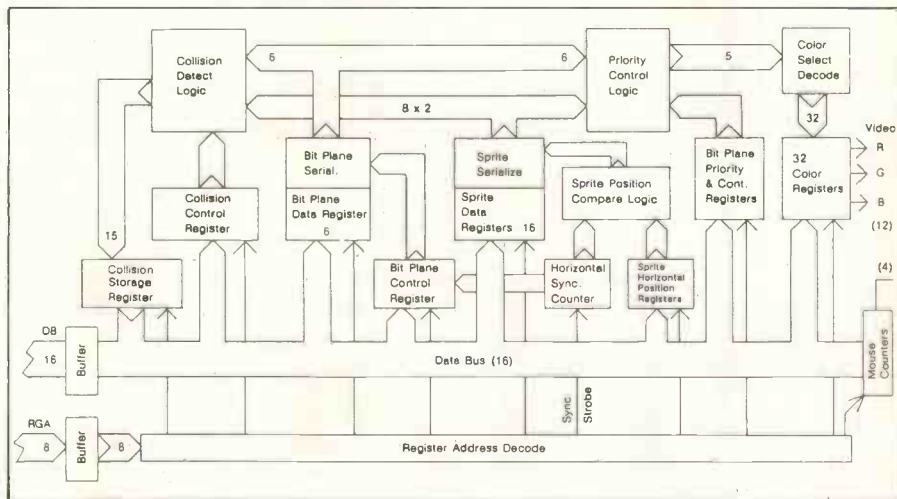

Fig 3 Daphne

it normally requires the attention of the processor.

With the blitter finding memory and transferring its contents around, however, the RAM disk works as though it were a separate computer with its own memory, just waiting to feed information into the system.

System software

The Amiga's operating system is a specially customised version of the Cambridge Tripos operating system. It was written for Commodore by Metacomco in Bristol, which licences the software on the 68000.

The advantages of this operating system are greater than you'd expect from an almost totally unknown piece of technology. Tripos, for those who missed that bit of history, means a three-legged stool, a stool such as Cambridge undergraduates sat on when taking examinations (a few centuries back). It then became the joke name for a three-part degree at Cambridge, and because it ends in OS, was stolen as the name for a network operating system.

The network is the Cambridge Ring, a token passing network of high speed and reportedly high reliability. Tripos, therefore, is a highly debugged system of message passing. It assumes a multi-tasking system, and merely passes messages from process to process in order of priority.

To operate Tripos, the programmer merely has to assign priorities to the processes in such a way as to ensure that no low-priority process (from the user's point of view) hogs the machine.

AmigaDos includes Tripos, plus a very complex structure of other bits of system software. It's clearly beyond the scope of a machine review to try to provide guidelines for applications programmers so I'll skimp on the highly complex way that all the different parts of AmigaDos talk to each other, but it is worth covering some of the details of what they are meant to do.

There are several unusual, innovative and powerful features of the disk filing system, but a few basics first: the floppy disk doesn't use sectors, but complete tracks; there is no 'directory track' as such; all storage 'blocks' are message packets; and there are no arbitrary limits to anything.

Having established those few ground facts, these are some of the implications. The DOS is an asynchronous filing system, suitable for a multi-tasking system. For every task it keeps a buffer for the disk, and writes to the buffer, not the disk. The buffer is in two parts: a track cache, and within that, block caches. Writing to the disk itself is a low-priority task, and will in any case wait for five seconds between buffer write and disk update.

This does make the system vulnerable to power failure, in theory at least. As far as an applications program is concerned, if it says 'close' a file, the

DOS will report that it is closed as much as five seconds before the closed file is written to disk — or perhaps even longer if another higher priority application is doing disk work.

However, there are safety features built into the file structure which are based on the requirements of message passing. And in fact, on analysis, the system is actually safer than a conventional system. Consider the directory of an AmigaDos disk: the essentially cunning feature of the filing system is the fact that blocks do not point only to the next block of the file. A block has a header which points to the next blocks in the file, and (more important) points back to the previous block.

According to the Metacomco's Tim

'... the Amiga is the first low-cost, multi-tasking computer, introducing a new price level to business computing.'

King, who wrote the AmigaDos, this has one powerful advantage. 'It means that, given one good block, we can reconstruct most of the disk. From one block we can trace back to the core directory, in a central track on the disk (for safety), and from there can reconstruct all the pointers to all other blocks.'

In writing to disk, the DOS indicates whether a file has been modified, and un-closed files are flagged and usable. In contrast, of course, a disk file on a more conventional system which was being over-written at power-down would be lost forever, and worse, would be corrupted.

The drawback is that the system doesn't pop up with a list of files when asked to list the directory. It has to do a search, using a hashing algorithm to find them first, and this can take a few seconds, with the data coming off the disk surprisingly slowly by CP/M standards.

Don't grumble. On CP/M or MS-DOS directories, the contents of the directory, if scrambled, can mean you will never trace a single file again. The directory is a data stream, which can be altered by any careless programmer or user, and has no inherent relationship to the data on the disk at all. But on AmigaDos, the data is the directory. And if you use a RAM disk, the directory listing will take microseconds.

The fact that the disk controller reads in a whole track, without sectors, will probably have important consequences for copy-protection. The 'invisible' information between sectors is often used to confuse disk filing systems. On this disk it's part of the data, and that explains why a double-sided Sony floppy can hold 880k without speed tricks, as on the Macintosh.

Other points worth expanding on must include the fact that there are no arbitrary restrictions on anything. A directory can have as many sub-directories as you like, and each directory of a sub-directory can have as many entries as you like. A directory name can have up to 256 characters due to the name pointer being eight bits large, and that appears to be the only restriction. A file can be as big as the data in it: there isn't even a restriction on how many disks a file can be stretched over.

There are no 'types' of file. There is no end-of-file character, for example, because the file header blocks always specify exactly how long a file is. There are no 'sequential' or 'random' files — they can all be read sequentially or randomly.

Finally, a little quirk which I particularly like: DOS supports 'scatter loading'. This means that a 100k program can be loaded, even if there is no free block in memory bigger than 2k. As the program is loaded, all new jumps are calculated and inserted in the code. (This doesn't work, incidentally, with data space, which has to be allocated in contiguous blocks (unless an application is clever

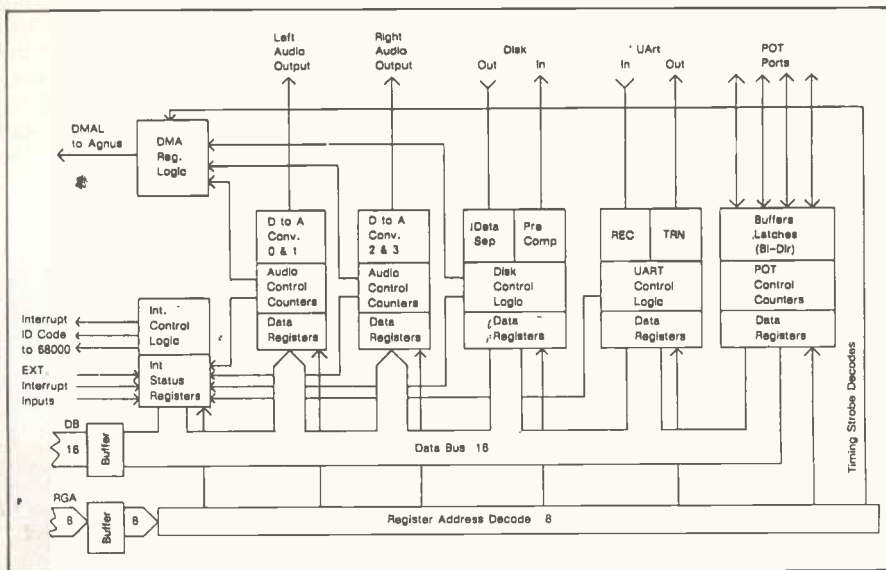

Fig 4 Portia

enough to do otherwise) by the operating system.)

When you switch on the Amiga it requests the 'kick-start' disk. This isn't a permanent feature, but a way of debugging the enormous (192k or possibly more) amount of operating code in ROM.

For the first six months or so, this ROM will be supplied on disk. Commodore argues that it isn't possible to produce the Amiga in a fully tested form without some public feedback, so the first thing the machine will do is fill up a special section of RAM memory with this code, and then it will turn off the write-enable line. The RAM will become read-only, and, until power-off, the code will remain there (unlike the Atari, where pressing RESET will require the operating system to be entirely loaded again) until power-down.

On the screen, after kick-start, will be a disk icon referring to the diskette you put in memory. There will also be a funny little icon with nothing on it but a 1> prompt. This is the 'command line interface' (CLI) option. Click on it with the mouse, and it turns the machine into an ordinary keyboard-driven micro, working rather like a Unix, or CP/M, or any ordinary computer system. To use this, you have to remember the system commands to get directories, start a program running, examine files, copy files, format disks, and so on.

Most users will never see this, and will drive the system with a mouse and the icons. But the option is there and is important, as you will realise when I describe the Basic.

The mouse-driven icons are collectively called the 'Workbench', and this is a program which can be loaded. It is possible to have the Workbench running as one task alongside another

program, or several others, or several Workbenches. All you need is memory, and everything is optional.

The interface between application and user is a program called Intuition. Anyone who has seen a Macintosh working will recognise this at once as the way in which a programmer provides little command boxes, little response gadgets, and control bars. As with the Macintosh, Intuition can give you the ability to change the size or shape of a window. It gives scroll bars and put-away slots.

In addition, however, there is a 'gas tank' option, showing how much memory has been used from the free space available. There is also a new control gadget, the above-below gadget, which uses the hardware that keeps track of bit-planes. It can tell which window is visible and which is hidden, but, unlike normal windowing systems, this one keeps writing to invisible windows.

For the untrained user, this is bound to be confusing as one assumes, naturally, that the active window is the one on top. But it isn't. You can have an active input window, invisible, underneath another window displaying output. For example, you can order a word processor to load a file, then realise you don't have the right name. You open another window, ask for the directory, and as the right name comes past, type it in to the word processing window.

The Amiga is an 'open architecture' computer, with all information available from Commodore. Obviously some of the manuals will be cheaper than others, but one thing that will be well documented is the concept of a library.

Library functions exist in ROM, but you can create your own. These include all operating system control calls, which means that if a programming language doesn't have a feature, you can call a library routine. If the library routine doesn't exist, someone can write it, or you can do it yourself with the ADD LIBRARY call to the EXEC, which itself does so many things that it's easier to say what it doesn't do, and that's any input or output. It's the primary software module for the system, controlling tasks, scheduling, memory allocation and 'devices'.

EXEC is one of the library calls, and it is the one which is invoked at power-up. It's the only fixed-location routine in the whole system.

An understanding of the power of the EXEC is essential to the writing of serious software for the Amiga, but I suggest that you get the system documentation if the idea of tasks, processes and devices interests you. It's of purely academic interest to the average user. However, it is worth pointing out that no part of the operating system or ROM routines is essential. Apart from EXEC, every other piece of code can be dispensed with, and the simple bootstrap loader can be used to read in your own operating code. For such things as big games, this could save an enormous amount of memory space.

The previously mentioned command line interpreter has several interesting instructions which it will obey, which aren't found on other systems. Before listing some of these, it's worth pointing out that both the Workbench and the CLI are, like any other task, capable of running in parallel. One of the CLI commands is NEWCLI, which opens up a window with a new prompt. The first CLI window has a 1> prompt. The second has a 2>, the third a 3>, and so on.

But Workbenches can be started from the CLI, and CLIs from the Workbench, too. The only restriction, as with everything else on the Amiga, is the amount of memory you have plugged in. With that 20Mbyte disk, plus 2Mbyte memory coming from Tecmar, I don't expect many business users to be short of memory.

Commands which I like include SEARCH, EXEC, RUN, and COPY. SEARCH makes the question of long file names seem almost irrelevant. You can

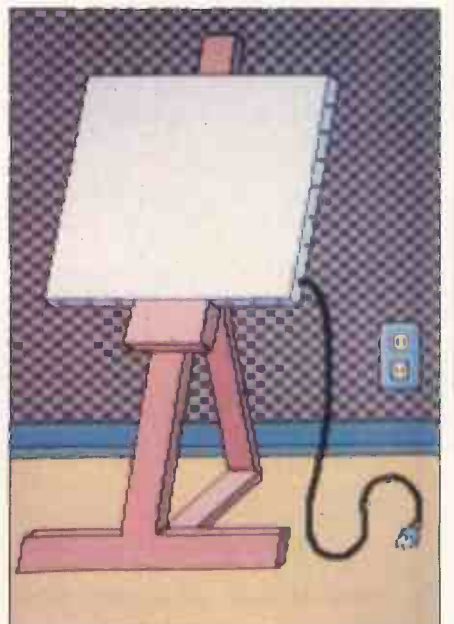

Graphics created on a prototype Graphicraft by Island Graphics.

ask SEARCH to find a file in which a word, or phrase, or pair of disconnected words occur, almost as if you had a database manager. It would be foolish to search on a hard disk through all directories as it would take a while, but it will find it.

EXEC is the batch-file invocation. Unlike the .BAT or .SUB files we're used to, this includes complex IF and SKIP commands.

RUN invokes an application as a background task, which opens its own window and closes it when dismissed. To load an application normally, you'd type its name and it would run in the existing window.

But better than all these features is the help ability: type a command and a question mark, and the system will remind you of the inputs you have to put in and the ones you can leave out. Therefore, "COPY?" will give you FROM, TO/A, ALL/S, QUIET/SI, which will need the manual for interpretation the first time, but will be quite obvious thereafter. It's not the same as a pull-down menu, but it's close.

All commands, when specifying input and output, involve channel numbers (Amstrad users will recognise this) rather than hard devices. You can specify the printer as a channel and copy a file to it, or you can specify a particular window and copy it there.

Tripes is a network operating system. AmigaDos doesn't include a network operating section, but due to its structure, local networks of computers will need a trivial addition to the operating system, which already takes care of file-locking.

However, as there is no record-locking feature, any Amiga network will need a new version of the DOS, before multi-user networks are set up. Locking is controlled down to the block level, but for shared access, 'more granularity is needed,' conceded Tim King at Metacomco. This factor appears to be a simple oversight, and I gather it is correctable.

Multi-tasking is a problem for most operating systems, simply because it takes such a long time to get it debugged. Tripes, says Metacomco, has been around long enough to be stable, but is new enough not to be outdated. I suppose, in a way, the very fact that it wasn't rushed out for a new micro, but bought off the shelf, allowed the developers to mature it without the pressure of having to deal with hundreds of thousands of angry users who wanted Version Two.

Time alone will tell whether AmigaDos is capable of withstanding a software crash in one application. My cynical soul tells me it won't be in the first week of availability that this question is finally answered.

Applications software

The Amiga's Basic is Digital Research's Personal Basic. It was written for DR by Metacomco, and has now been up-

graded to run on this machine and support its new features, so there are many new commands you won't find in Personal Basic any more than you would have found them in Microsoft Basic, of which Personal Basic is workalike.

Having said that it supports the machine's new features, I have given all the praise I am going to give. Microsoft, when it launched the Basic for the IBM, fell into a similar trap of rushing out a hopelessly inadequate, ill-prepared language. The company then had to sit down and write Advanced Basic (Basic-A) to take advantage of the steps the language had made since MBasic was written. So it is with AmigaBasiC (ABC). Its editor is ridiculous. There are obvious commands which it should have. It is at least two years out of date, and it isn't particularly fast.

The editor is a line editor. It's based on the Microsoft line editor, but it leaves out several of Microsoft's undocumented features. For example, control-A on Microsoft Basic will give you the previous command line, ready for editing. Not here: as with the CLI, you have to retype any command containing errors.

Metacomco says it wants a full-screen editor, and will do one. I can't wait. You can't even use the cursor keys when editing — very strange (undocumented) things seem to happen. This bug should be moved very soon.

Metacomco doesn't contest most of these objections, and says solemnly that this 'is the opportunity we've wanted for some time, to develop our Basic,' and that it is aware of what it wants to do. For example, the company agrees that line numbers are an option for labelling purposes, not a necessity. It agrees that a mouse-driven machine ought to have a mouse-driven Basic editor, and it concedes that a system with a real-time clock and calendar ought to be able to read it.

The saving feature of the Basic is the command SHELL "", into which any CLI command can be fed. The other is the library call command, which is available from every language on the system and looks infinitely more powerful than USR invocations. Between these two, the full power of the machine can be tapped from the silliest of programming languages.

The virtue of Basic, of course, is that it

does give the beginner a chance to experiment with the sound and animation potential of the machine, but I hope the language will be improved very soon.

From Basic, all the Amiga's multi-tasking features are available to the user; the only restriction is workspace. However, one essential feature, if this isn't to be a problem for entry-level users, is control of the workspace size. At press time, it transpired that everyone thought it was possible to define the workspace, but no-one had actually done it.

The result is a 256k system with 40k of program space for Basic. That's irritating. What's annoying is that if you run four Basic tasks in four windows, you'll use up your memory because there's no way of telling Basic that you only need 2k for a silly little display routine — it gives you the full slab.

I understand that this will be corrected and Basic will get a parameter to set the workspace size.

Languages other than Basic which will be available for the machine at launch (at a price) will include Metacomco's assembler, Borland's Turbo Pascal, Lattice C compiler and a version of Logo. The system is heavily C oriented, with most of the systems software written in that language, or hand-coded.

As an optional peripheral, a 5 $\frac{1}{2}$ " disk can be plugged in. This can obviously read IBM diskettes. What isn't obvious, and may be regarded as over-ambitious, is a program, bundled with the drive, that emulates an IBM PC. Commodore swears that it's good — good enough to run Lotus 1-2-3. 'It won't be a substitute for the proper way of doing it,' the company says, 'but if you're working in an office with people who have 1-2-3 disks, at least you'll be able to take their outlines and change bits and put them back.'

Astonishingly, this should sell for under \$500. I hardly dare to believe it. I can confirm, however, that the box will *not* contain an Intel 8088 chip.

At the time of writing this review, it unfortunately wasn't possible to obtain hands-on experience of the business packages expected to be available at the Amiga's launch. These packages include an entry-level word processor similar to MacWrite. For an entry-level system it's reported to be quite sophisticated, and many people have said that it is actually the nicest editor they've seen. I can only pass on their opinion — unbiased because they are not Amiga employees, but not necessarily informed because they aren't all word processing experts.

Also available at the launch will be an entry-level paint/draw package. This is said to work at many times the speed of MacPaint, and it should, shouldn't it? A music synthesiser program, a speech control and editing program, and a spreadsheet are also expected. A database, however, is still 'an area of

Benchmarks	
B1	0.75
B2	2.07
B3	4.53
B4	4.87
B5	5.60
B6	10.39
B7	7.84
B8	11.33

All timings in seconds. For a full listing of the Benchmark programs, see page 185, January issue.

weakness,' say the developers, and they are negotiating for one. Communications software is also likely. (None of these packages will be bundled in with the price.)

Games are also on the horizon, despite the fact that at \$1200 minus the type of colour display you really need to appreciate this machine, you might think that it wouldn't really be used for games. Software producers aren't so sure of this. I've spoken to people who are doing games, and are simply totally wrapped up in the glory of what is possible.

The fact of the matter is that no games producer could resist the challenge or the opportunities offered by Amiga, and I expect them to come thick and fast in a year's time, when there should be a half million or so Amigas being used in

the US.

Similarly, new types of software should appear. When the Macintosh first arrived, people laughed at the idea of a mouse. The Amiga does so many things so much faster, with so much more detail and with the added advantage of colour, that I expect it to generate similar innovation.

I expect to see much more sophisticated programs, too, because of the multi-tasking ability and because most business users will have 20Mbytes of disk and 2.5Mbytes of RAM, within a year. Integration becomes less important when you have multi-tasking, and individual word processing, spreadsheet, comms and other ideas packages can be more virtuoso in their design. A talking word processing package is an obvious start . . .

Although there are few instant similarities between the Macintosh and the Amiga, both do use the 68000 and have high-level languages. I expect to see best-selling Macintosh programs coming onto the Amiga within weeks of its availability. Even programmers who have held aloof because of the non-disclosure requirements imposed by Commodore admit that it would normally take a matter of weeks, not months, to transfer new Macintosh programs to the new machine. I believe them.

Documentation

I hate to duck out of the important question of documentation, but so little was ready when I did the Benchtest that I don't feel I can honestly express an opinion. What I did see was lucid and helpful, but I think there's scope for books on the machine.

Prices

As the European version of the video chip isn't ready, the machine won't be available in Europe until January 1986. It isn't just a question of getting output to TV, but of getting input from the European video sources; this makes a PAL interface essential.

Traditionally, Commodore has priced in Europe along similar lines to the US. The machine is made entirely in the Far East and all the development work is paid for, so there isn't any real need to expect UK prices to be different from American ones. We can expect a naked, 256k system with a built-in disk but no display to sell for around £1000 — roughly comparable with the price of the Apricot F1.

The add-on memory should sell for £150 for 256k. The add-on Sony disks should be priced around the same, at £150. The Tecmar hard disk, at \$1000, will probably cost around £1000 in the UK. At press time, software prices were still being fought about in California, and your guess is as good as mine.

The plan is to have the review model as just the first of a range of Amiga machines, and it looks likely that the price of this one will drop as the bigger ones appear — but that's some way in the future.

Conclusion

Although the Basic Benchmarks don't prove it, this machine runs upwards of 10 times the speed of any of its rivals. It adds hardware animation, video input, and stereo sound synthesis, including speech, to the icon-and-mouse family of designs which the market has come to expect, and offers it all at a price less than half of that of the competition.

To close as I began, the Amiga is the first low-cost, multi-tasking computer, introducing a new price level to business computing.

END

Technical specifications

Processor:	Motorola 68000 at 8MHz clock
ROM:	192k, possibly 256k
RAM:	256k minimum, expandable to 8Mbytes
Mass storage:	Internal 800k floppy, 3½in. External options include another 800k floppy using system power, and two more with exterior power. Hard disks fit on expansion slot
Keyboard:	Full-travel qwerty with cursor keys
Size:	4.75ins high × 17.5ins wide × 13ins deep
I/O:	Serial, parallel, video out and in, stereo sound, mouse
Dos:	Tripos, called AmigaDos
Bundled software:	Basic, Dos, Exec, no applications peripherals. Colour printers supported, video disk interface available

In perspective

The Amiga, at \$1500 for a colour system, is obviously going to be a business machine first and foremost. Its massive memory capacity means that people with \$3000 to spend will do so, getting a machine which spending \$6000 on an IBM wouldn't match, and which comfortably out-performs the Macintosh.

Anyone who is comparing this with the Atari 520ST will quickly decide that the only reason for buying the Atari is the price. If you can afford the Amiga, that is the one you will want.

For the next six months, the Macintosh will have the clear advantage of a growing and impressive software base. However, the news from within Apple indicates a level of unjustified complacency about the Mac. The Fast Mac has been postponed; the Colour Mac, due out in February, is no longer being developed; and the Hard Mac, due in September, is also on ice.

This is not the time for Apple to go to sleep. The Amiga has the price advantage. It is an open architecture machine, onto which anyone can attach anything. All the system calls will be published, and it is nearly 10 times as fast and has genuine multi-tasking, which the Macintosh won't have for at least another 18 months.

The only other problem Amiga faces is: can IBM tart up the PC 11 and the AT, with windowing and icons, in time to match its facilities? The theoretical answer is yes, but in practice, is there any sign of it? IBM is fiddling around with TopView, which isn't even as good as the small-time Desq and doesn't have graphics. It grows each time I hear about it, and gets slower and slower.

Microsoft Windows on the PC is Microsoft's watershed — the time has come to put up or shut up. It may pose a serious threat, but it doesn't have the raw computing power or even a fraction of it. Perhaps it will be good enough to keep users loyal, but will it attract new ones?

In the end, it comes down to innovation. The Amiga does things that other micros can't do. In the past, the computer market has always shown that genuine innovation creates new sub-markets, and I'll be astonished if the Amiga doesn't do exactly that — and many of them.

The world didn't need another portable. Just a better one.

The Bondwell 2 is a truly portable computer that offers instant computing power when you're on the move. And it offers some pretty remarkable features.

Small, light, powerful.

The Bondwell 2 is a 64K RAM portable that is the size of an attache case and weighs just 5.5 Kg. The fold-up LCD screen offers 80 characters x 25 lines with a brilliant resolution of 640 x 200. It also tilts 0° — 180° to offer the best viewing angle in all light conditions.

There's also a built-in 3½" microfloppy disk drive with a 360K formatted capacity. So you get maximum software flexibility without the limitations of built-in ROM programs on most portables.

And because the Bondwell 2 has a CP/M 2.2 operating system you have access to a huge library of business programs.

Five top programs are offered free with the Bondwell 2 — WordStar, Mailmerge, DataStar, CalcStar and ReportStar. As well a "Scheduler Plus" program is yours, free, for better organisation of executive time.

Features. Features. Features.

Other Bondwell 2 features include a full-stroke keyboard with 8 user-defined function keys; ports for data transmission, printer and a second disk drive; expansion slots for modem, ROM/RAM card; a built-in battery which gives 8 hours of continuous use with each recharge.



The Bondwell 2 Portable.

**Heavy in features. Light in weight.
And equally light on the pocket**

AT £1575

**Barbatan
Limited**

35 - 38 High Street
Bristol BS1 2AW
Tel: Bristol (0272) 213928

Attractive trade discounts are available.
Dealer enquiries welcome.

Frankly functional

Function follows form, as functional programming takes up where structured programming leaves off. David Elworthy presents some Basic examples.

One of the peculiarities of Basic is that it is not really a single language at all, but a large and diverse family of dialects. Although this has some bad consequences, for example the lack of portability, there are compensations. Designers of new Basics can freely include good ideas from other languages by just bolting them onto the basic framework rather than having to create a complete language from scratch. The most important example of this is the inclusion of structuring which took off with BBC Basic.

The concept of structuring has been around since the 1960s, when the likes of Dijkstra and Wirth began to look at programming style. Their aim was to trade off execution speed against the ease of understanding and debugging programs, and their work led to such principles as top-down design, block structuring and the abolition of GOTOs. Structured programming caught on, and most modern general-purpose languages draw on such ideas.

But structured programming still has its problems, and there is at present research going on into a new type of programming, called 'functional programming', to further improve style. This is a rather speculative look at some of the new principles, and how they might be added into Basic. A number of the ideas can be simulated using a structured Basic, and I'll show how this can be done using BBC Basic as an example. Programs using this kind of simulation are rather inefficient, but I hope to illustrate just how clever and versatile functional programming is.

No more variables

Functional programming abolishes variables, and the obvious question is: 'Why bother?'. The problem with variables is one of scope: that is, knowing when they exist. In order to be able to understand what is happening in a program, it is useful to know exactly what any part of it does in terms of the effects and results it produces when certain values are applied to it. This is simply not possible in most languages because of what is called the 'side effects' problem. An example of this is a procedure which uses variables that are not mentioned in the arguments, poss-

```

>LIST
10REM Program 1a - non functional factorial
20X = 5
30factorial = 1
40FOR I = 2 TO X: factorial = factorial * I: NEXT I
50PRINT factorial
>
>RUN
120
>
>
>
>LIST
10REM Program 1b - functional factorial
20PRINT FNfactorial(5)
30END
40
50DEFFNfactorial(x): IF x < 2 THEN = 1 ELSE = x * FNfactorial(x - 1)
>
>RUN
120
>
>
>
>LIST
10REM Program 2 - a more complex functional program
20PRINT FNleftinsert("B","ACD")
30END
40
50DEFFNleftinsert(char$,into$)
60 IF ASC(char$) <= ASC(into$) THEN = char$ + into$
70 = LEFT$(into$,1) + FNrightinsert(char$, MID$(into$,2))
80
90DEFFNrightinsert(char$,into$)
100 IF ASC(char$) >= ASC(RIGHT$(into$,1)) THEN = into$ + char$
110 = FNleftinsert(char$, LEFT$(into$, LEN(into$) - 1)) + RIGHT$(into$,1)
>
>RUN
ABCD
>
>
>
>LIST
10REM Program 3 - functional Hanoi program
20PRINT FNhanoi(4,"a","b","c")
30END
40
50DEFFNhanoi(n,a$,b$,c$)
60 IF n=0 THEN = "" ELSE =FNhanoi(n-1,a$,c$,b$)+CHR$(13)+CHR$(10)+"From "+a$+"
to "+b$+FNhanoi(n-1,c$,b$,a$)
>
>RUN
From a to c
From a to b
From c to b
From a to c
From b to a
From b to c
From a to c
From a to b
From c to b
From c to a
From b to a
From c to b
From a to c
From a to b
From c to b
From a to c
From a to b
From c to b
>
>
>
>LIST
10REM Program 4a - IF in functional style
20INPUT x,y
30PRINT FNif("FNequal(x,y)", "SQR(x)", "EXP(y)")
40REM i.e. if x=y, print the square root of s, else print e to the power y
50END
60
70DEFFNif(cond$,then$,else$) = EVAL(EVAL(EVAL(cond$) + "(then$,else$)"))
80
90DEFFNtrue(a$,b$) = a$
100DEFFNfalse(a$,b$) = b$
110

```

Fig 1 Programs 1a, 1b, 2, 3, 4a, 4b, 5a and 5b

Fig 1 continued

```

120REM Now a typical conditional. This uses the numeric values of
130REM true (-1) and false (0) to make 0 or 1 copy of each string
140DEFNEqual(a,b) = STRING$(-(a=b),"FNtrue") +STRING$(1+(a=b),"FNfalse")
>
>RUN
?2,1
2.71828183
>RUN
?2,2
1.41421356
>
>
>
>
>LIST
10REM Program 4b - IF in functional style
20INPUT x,y
30PRINT FNif("FNequal(x,y)","x+y","FNif("FNequal(x,0)","SOR(y)","EXP(y)
")")
40REM i.e. if x=y, print x+y; otherwise, if x=0, print sqr(y), else print exp
(y)
50END
60
65REM The rest is the same as 4a
70DEFNif(cond$,then$,else$) = EVAL(EVAL(cond$) + "(then$,else$)")
80
90DEFNtrue(a$,b$) = a$
100DEFNfalse(a$,b$) = b$
110
120REM Now a typical conditional. This uses the numeric values of
130REM true (-1) and false (0) to make 0 or 1 copy of each string
140DEFNEqual(a,b) = STRING$(-(a=b),"FNtrue") +STRING$(1+(a=b),"FNfalse")
>
>RUN
?2,2
4
>RUN
?0,2
1.41421356
>RUN
?2,1
2.71828183
>
>
>
>
>LIST
10REM Program 5a - lazy evaluation
20REM <x means pair
30PRINT FNlazy("<xFNintegers(0)")
40END
50
60DEFNlazy(a$)
70 IF a$="" THEN ""
80 PRINT LEFT$(a$, INSTR(a$, "<x") - 1)
90 = FNlazy(EVAL(MID$(a$, INSTR(a$, "<x") + 2)))
100
110DEFNintegers(start%) = STR$(start%) + "<xFNintegers(" + STR$(start% + 1) +
")"
>
>
>LIST
10REM Program 5b - lazy evaluation without tail recursion
20REM <x means pair
30PRINT FNlazy("<xFNintegers(0)")
40END
50
60DEFNlazy(a$)
70 IF a$="" THEN ""
80 PRINT LEFT$(a$, INSTR(a$, "<x") - 1)
90 a$ = EVAL(MID$(a$, INSTR(a$, "<x") + 2)); GOTO 70
100
110DEFNintegers(start%) = STR$(start%) + "<xFNintegers(" + STR$(start% + 1) +
")"
>

```

ibly changing their value. When this is allowed, two calls of the procedure may give different results, even though the procedure call is the same. (For example: given DEFPROCnasty(x): A = A + 1: PRINT A: ENDPROC, then A = 0 : PROCnasty(0) : PROCnasty(0) prints 1 and then 2: that is, PROCnasty(0) is not equal to PROCnasty(0)!)

In structured programming, you can get round this by making sure all variables are either declared as local or are function parameters, but many languages don't force you to do this so the loophole is used either by accident or as a result of laziness.

It is often easy to remove variables from a program. Programs 1a and 1b (Fig 1) show the factorial function written in two styles: the first is conventional and uses variables; the second is purely as a function and doesn't. x in Program 1b may look like a variable, but might more accurately be

called a parameter as it doesn't vary once it has acquired a value in the function call. As the function parameter is distinct from anything else with the same name (even in a different call of the same function), it is safe from side effects.

Program 2 is a functional program which tries to insert char\$ into the ordered string into\$ by chopping each end off in turn (there are better ways of doing this). Again, there are no assignments. What each function does is to either yield a definite value or to invoke another function (this is where the name 'functional programming' comes from). The action of the program as a whole is just a call to a single function, which in turn calls others, and so on, until something comes up with a definite answer which can be passed up to higher levels.

There is an interesting consequence of this. Program 3 (Fig 1) is a function to

solve the well-known Towers of Hanoi problem. a\$, b\$ and c\$ are the names of the towers, and n is the number of discs which are initially all on tower 'a'. The program lists what moves to make, but it doesn't produce any output at all until it has worked out the whole of the answer. With the simple style of functional programming given so far there is no way round this, which is a bit of nuisance — no interactive programs, for example, as you don't see the prompts, and so on, until the end.

IF...THEN...ELSE

With a small addition, this style can be transformed into a remarkably powerful technique. For example, here's how the construct IF...THEN...ELSE could be added to functional Basic if the designer of the language had not included it.

The key is to allow a function to supply the name of another function as its result; the result can then be applied to further arguments. To do this, we need some means of invoking evaluation of a function, and BBC Basic provides this by means of EVAL. In real functional programming languages, the evaluation is often automatic; Lisp takes a similar approach.

Program 4a (Fig 1) uses the functional 'if'. For this we require a set of conditional functions, of which FNequal is an example; these return the name of a function as their result. FNif can then evaluate the condition, and EVALs the result of it applied to the arguments then\$ and else\$. The result of doing this is evaluated one more time, so that the then and else parameters can themselves be functions (in fact, anything at all, except string constants). An interesting point is that true and false, which are normally thought of as values, are now functions, albeit rather simple ones which just choose one of their arguments.

This form of if statement is completely general. then\$ and else\$ could themselves be if functions, or contain EVALs so that evaluation can be nested to any depth. Program 4b (Fig 1) is an example.

You might like to see what other parts of Basic can be thrown away using a similar approach. Real functional programming languages have very few built-in constructs.

Lazy evaluation

It is rather restrictive to have to wait until all the functions have been fully evaluated before producing the result. Not only does it eliminate interaction, but it could also mean that the program runs out of memory because of all the output that has to be saved until the program has finished.

A solution to this is to use what is called 'lazy evaluation'. (The opposite case, that is, evaluating everything, is called 'strict evaluation'.) Here, what we do is work out just as much as is necessary to print the first part of the result, and keep a record of what there is

left to do by passing around the name of a function and some arguments as before. In functional programming languages, this is normally done by defining some functions to be lazy and having an output routine that can spot unevaluated objects. The routine is then supplied with a pair of items, of which the second is only evaluated when the result of the first has been printed. The function that makes pairs can then be lazy.

Program 5a (Fig 1) shows how to do lazy evaluation in functional additions to Basic. FNlazy expects its argument to have the form:

"something-to-be-printed<>next-thing-to-do"

where <> means 'pair'. If the first part of this is null, we stop. The program shows how to use this by producing the infinite list of natural numbers within the limits of the range of integers allowed. The print command is a bit of a cheat as it isn't a function, but unfortunately there's no easy way round this. (Input could be made functional by using GET\$.)

The one remaining difficulty with FNlazy is that BBC Basic does not allow very deep recursion, so it soon gives a 'no room' error. This kind of recursion (known as tail recursion) frequently occurs, and can be eliminated as shown in Program 5b (Fig 1). Unfortunately, this violates both the 'no GOTOs' rule and the 'no variables' rule, although both are actually quite safe — the variable is known to be local and the GOTO is short-scope.

Many structures and functional programming languages specifically look for tail recursion and internally translate it into a construct like this. That way, the programmer isn't breaking the rules and the system can work efficiently.

You could now rewrite the Hanoi program using lazy evaluation and a functional IF.

Referential transparency

Referential transparency can't be easily written into Basic. It is never doing the same thing twice: that is, if at some stage you have evaluated a function with certain arguments and you then come to the same instance again, rather than work out the result a second time, you just look it up from before. This is not always possible to do completely, but the general approach is as follows.

The application of a function to some arguments is represented as values sitting around in memory. When another function wants the result of it, it looks at that area of memory and sees that the function has not yet been evaluated. Having carried out the evaluation, as well as taking the result away for its own use, it replaces the contents of that area of memory with the result, and an indication that it has already

```
Letrec histoline == Int n -> Char c -> List[Char]:
```

```
  If (n=0)
```

```
  Then "'n"
```

```
  Else c :: histoline (n-1) c
```

```
Fi;
```

```
Letrec histogram == List[Int] sizes -> Char symbol -> Int max -> List[Char]:
```

```
  If null sizes
```

```
  Then histoline max '=
```

```
  Else append (histoline (head sizes) symbol)
```

```
    (histogram (tail sizes) symbol
```

```
      (If ((head sizes) > max)
```

```
        Then head sizes
```

```
        Else max
```

```
      Fi))
```

```
Fi;
```

```
histogram (5 :: 10 :: 3 :: 17 :: 6 :: 1 :: 4) ** 0
```

Fig 2 Program 6

been evaluated. Next time something wants the result of that particular function application, it need only look up the result.

The two calls to the function must know that they are the same, otherwise there are simply two identical applications at different places in memory. This is where the main problem in implementing referential transparency arises — spotting when things will be

'Structured programming caught on, and most modern general-purpose languages draw on such ideas. But structured programming still has its problems . . .'

the same.

Another difficulty is the input function. We don't want GET\$ (or whatever) to have this kind of transparency: if it did, it would keep on giving back the character it had read the first time it was called. An elegant solution is to represent the input as an infinitely long list of characters, using a similar method to that for the infinite list of numbers in Program 5 (Fig 1). The program can manipulate the list freely, but the system need only read as much of it as is

necessary to get to the character that is needed. The remainder can just be a reference to a function which gets more input (and which is hidden from the user).

The final program is written in a real functional programming language (see Program 6 (Fig 2)). It is written in Ponder, a language developed at Cambridge.

The program prints a histogram with line lengths taken from the list of numbers in the last line, together with an axis equal in length to the longest line. The only parts of this which are built into Ponder are the constructs Letrec, and functions such as head, null and >. The rest is defined in Ponder itself (in a separate prelude).

Conclusion

There are several aspects of functional programming languages which I cannot describe in detail here. For example, functional programs should be amenable to theoretical analysis of whether they are correct, without the need to run the program on all possible forms of the data. Another intriguing idea is that of using them on multiple processor systems: you let a separate processor loose on each function (at some level), and combine their results when they have finished.

Thanks to Jon Fairbairn for his (unwitting) help in the preparation of this article.

END

► **LOGISTIX** (n) a powerful spreadsheet with an extensive database and containing truly superior presentation-quality graphics. *Logistix also includes: the fourth dimension — (1) time management; (2) resource allocation; (3) task scheduling; (4) project planning. Commonly referred to as ‘... the best idea in business software since the spreadsheet’.*

THE INDISPENSABLE PLANNING AND DECISION AID

No business remains static. You need to know not only what is going on today, but what should be happening next week, next month or next year. So you need the right kind of information in a form you can use and understand, you need to be able to analyse it in various ways and you need to be able to present it to others. Most important of all, you need to make decisions about the future. In short, you need to plan.

Logistix adds the all-important feature of time management to classic spreadsheet features, an extensive database capability and presentation quality graphics, to provide a versatile, powerful and easy to use planning and decision aid for managers and professionals.

LOGISTIX — The best idea in business software since the spreadsheet.

- DATABASE
- TIMESHEET
- SPREADSHEET
- GRAPHICS



Grafox Limited
65 Banbury Road
Oxford OX2 6PE
Tel. (0865) 516281

Kaypro 286i vs Compaq 286

Is it worth buying a PC/AT lookalike? Peter Bright weighs up the respective merits of the Kaypro 286i and the Compaq Desktop 286, and identifies some distinguishing features that set them apart from other PC-compatibles.



Whatever happened to the IBM PC/AT? When it was launched it looked like a nice machine — it may even have been good value for money. Then we began to hear stories about hard disks that kept dying, and now IBM is said to be rationing dealers.

All this has got to such a stage that PCW's editor is now having paranoid thoughts about the AT being in some way a hoax by IBM to fool the compatible manufacturers. If that's true, then the subjects of this Benchtest had better start worrying . . .

Kaypro 286i

Hardware

The 286i is very much an AT lookalike, the main difference being that where the PC/AT is cream, the Kaypro is black.

The main system unit is very large — too large, I would say, for the average desk. For this reason, Kaypro has provided extra-long monitor and keyboard leads so that you can place the main system box next to your desk rather than on top of it.

The main system box is constructed entirely of metal with none of the plastic facings of the Compaq or the PC/AT. This construction gives it a very square look which is only offset by a strip of rubber ribbing which runs along the joint between the top cover and the front panel.

The front panel itself is very reminiscent of the PC/AT. To the right-hand side are two half-height 5¼in floppy disk drives, and to the left-hand side is a lock and LEDs indicating power-on and hard disk access. The latter is included whether or not you have a hard disk fitted.

The lock is a copy of the type fitted to the PC/AT. You can disable the master keyboard to stop any unauthorised access to the machine. Unfortunately, unlike the PC/AT, it is perfectly possible to remove the lid and bypass the key even when the system is locked. This isn't possible on the AT because the lid is locked in place when you disable the keyboard.

The rear panel is also like that on the PC/AT, even down to the little plastic panel you can stick on to make it look nicer. To the left-hand side are power in and out, in the middle is a DIN socket for the keyboard, and to the right-hand side are removable covers for the eight expansion slots.

On the review machine two of these expansion slots were visible: one for colour video output, and one for a parallel printer and an RS232 port. The latter is extremely annoying because it uses a cut-down 9-pin D socket rather than the conventional 25-watt D plug. This means that none of the standard RS232 leads will fit.

Getting inside the Kaypro is achieved in exactly the same way as any IBM or compatible. You remove the five screws holding on the lid and then slide it off.

Inside there is a fair amount of empty space. To the right at the front are the cages to hold the floppy disk drives and the hard disk or disks. If a hard disk is fitted, it will be hidden from the user by the front panel as on the PC/AT.

To the right at the back is a very large fully-encased power supply/fan unit. The fan was quite noisy during the test and was certainly distracting in a quiet room. It also audibly slowed down when the disk drives were in operation. To the left of the power supply is a rechargeable battery pack providing power for the on-board clock/calendar.

The digital circuitry lives to the left and along the bottom of the main unit. The motherboard takes up three-quarters of the bottom of the casing; this houses the main Intel 6MHz 80286 processor, RAM, ROM, TTL logic cir-



The Kaypro 286i resembles that of the PC/AT, but is less solid

cuitry and eight expansion slots.

In its Kaypro implementation, the 80286 chip has sprouted a large heat sink on its back which I haven't seen on other machines, but it can't hurt. Next to the 80286 is a socket for an 80287 maths co-processor should you need it.

The review machine was supplied with 512k of RAM made up of 18 256kbit chips giving 512k with parity. Sockets are provided on the motherboard which allow the RAM to be increased to 640k by plugging in a further 18 64kbit RAM chips.

Almost all the chips on the motherboard were socketed. This is very unusual for a modern mass-produced machine due to the extra cost, but it does make it easier to replace faulty chips.

Of the eight full-length expansion slots, six are PC/AT-compatible enhanced slots and the remaining two are standard IBM PC slots. The basic system uses three slots, leaving five for future use. Of the three that are in use, one is taken by a half-length colour graphics card, one by a half-length parallel/serial card, and the third by a

disk controller card.

The disk controller card is the only one to make use of the full addressing and data path provided by the enhanced PC/AT slots. This one card controls both hard disks and floppy disks, including the 1.2 Mbyte disks used in the PC/AT.

The review machine was supplied with twin 1.2 Mbyte 5¼in floppy disk drives, which use the same special disks as the PC/AT. Although Kaypro makes no guarantees about the drive's ability to write 360k IBM PC disks, I had no problems reading or writing to that format. Hard disks are not yet available.

As you would expect, the keyboard on the 286i is a straight copy of that on the IBM PC/AT; the main difference being that the quality of construction is generally lower than that on the AT. It connects to the main unit via a long coiled cable and a DIN plug.

The main qwerty typing area takes up most of the space on the keyboard. On the left-hand side are 10 programmable function keys, and on its right-hand side are a combination numeric keypad and editing/cursor keys. In the top right-



The rear panel on the Kaypro 286i is identical to that of the PC/AT

hand corner of the keyboard are three LEDs to indicate CAPS LOCK, NUM LOCK and SCROLL LOCK.

The main good and bad points of the Kaypro keyboard are exactly the same as for the PC/AT. On the plus side, the RETURN key is now nice and big, and the '/' key has been moved from beside the 'Z'. On the minus side, the combination of numeric keypad and cursor keys is still a mess, and the positioning of the ESCAPE key with the numeric area is plain silly.

The main criticism of the Kaypro keyboard is the quality of construction. While nothing actually fell off, it just didn't feel as solid as the IBM or even the Compaq unit.

The only problem I had with the keyboard was that it would sometimes mysteriously return upper-case letters instead of lower-case. The only way out was to hit CAPS LOCK which returned it to lower-case! Then, equally mysteriously, the fault would clear and I would have to release CAPS LOCK. I never did find out why this was happening.

The review machine was supplied with Kaypro's own colour monitor, but unfortunately the review unit came from the US and needed a 110-volt transformer which caused some screen flicker. Obviously, 240-volt units should be better.

The monitor itself is rather large and very deep, and takes up quite a lot of space. The front houses an on/off switch and controls for brightness, contrast and display centring. Underneath is a little bar which can be locked down to tilt the display at an angle.

Although the display from the monitor is quite good, no attempt has been made to make the screen anti-reflective. As far as graphics resolution is concerned, the story is just the same as for an IBM PC with a colour graphics card.

System software

Now here's a new idea. You've just bought your nice new Kaypro 286i, you open the box and discover that to make it work, you've got to go to your nearest IBM dealer and ask him to sell you a copy of PC-DOS version 3.0. Fun, huh?

Really, things aren't quite as bad as that. In the UK, the Kaypro will be supplied with MS-DOS version 2.11 as used by PC compatibles. This will at least get you going, but for AT compatibility you will have to buy PC-DOS version 3.0.

When you boot up the system, it transpires that none of the system software can be attributed to Kaypro. The ROM-based BIOS routines were written by Phoenix Software Associates and sold to Kaypro. These ROM routines are popular among compatible manufacturers; the Wyse PC, Tandy



The Compaq Desktop 286 keyboard has a more positive feel than the Kaypro

100 and Commodore PC10 all use the Phoenix routines.

The only piece of software attributable to Kaypro was a system set-up utility to set the system parameters in the machine's battery-backed CMOS RAM. The utility allows you to set the clock and tell the system about disk drives, hard disks, display drivers, and so on. It also lets you tell the system how much RAM it has (up to a maximum of 15Mbytes!).

The operating system is identical to that on the PC/AT, right down to the documentation. (The AT was reviewed in PCW, December 1984.)

Applications software

It's difficult to talk about applications programs in any depth. To the best of my knowledge, no-one has released an applications program specifically for the PC/AT, so I am restricted to describing software compatibility with the IBM PC rather than with the PC/AT.

In these terms, the Kaypro 286i ran everything I expected it to. It ran Lotus 1-2-3, SuperCalc 3.2 and the rest. It didn't run Flight Simulator, but then neither will the PC/AT (something to do with a bug in the 8088 which has been

removed in the 80286, but which was used by Flight Simulator).

As with all Kaypro machines, the 286i comes with bundled applications software included in the price. In this case it is the MicroPro range, consisting of WordStar, Mailmerge, CalcStar, InfoStar and a menu-building package called Starburst. GW-Basic is also included in the package. If you look at the Benchmark timings, you will see that the Kaypro is marginally faster than the PC/AT.

Documentation

The Kaypro 286i came with a boxful of manuals. This was most impressive until I looked closer and found that all but one were manuals for the MicroPro applications programs and for GW-Basic.

The manual that referred to the machine was a scrawny-looking spiral-bound affair containing just 32 pages. I did find the manual quite useful, but I'm not sure how helpful it would be to a beginner.

Prices

The review system will sell for about £4136. A stripped-down version is also



The Compaq rear panel has a power supply socket for the Compaq monitor



authorised dealer

authorised dealer

olivetti

Olivetti M24 £1939+VAT

256k 2x360 k d/drive
12" monitor, MSDOS
FREE SC D100 120cps f/t
printer + cable
FREE Quill w/processor
FREE Abacus s/sheet
FREE Archive d/base
FREE Easel graphics
FREE 5 discs & paper

Apricot £1595+VAT

256k business system
2x315k d/s d/d
FREE 9" monitor
FREE SC D100 120cps f/t
printer & cable
FREE SuperWriter w/p
FREE SuperCalc s/sheet
FREE SuperPlanner
FREE 5 discs & paper

authorised dealer

COMPAQ

Compaq £1795+VAT

256k 2x360 k d/d
9" built-in monitor
FREE SC D100 120cps f/t
printer + cable
FREE Quill w/processor
FREE Abacus s/sheet
FREE Archive d/base
FREE Easel graphics
FREE 5 discs & paper

Olivetti M24 £1728+VAT

256k 2x360k d/d
12" monitor, MSDOS
FREE QuenData 20cps
d/wheel printer & cable
FREE Quill w/processor
FREE 5 discs & paper

Olivetti M24 £3202+VAT

640k business system
10MB hard disk
1x360k d/drive
Olivetti monitor, MSDOS
FREE Canon 1080 nlq
printer and cable
FREE Quill w/processor
FREE Abacus s/sheet
FREE Archive d/base
FREE Easel graphics
FREE discs & paper

Apricot £1795+VAT

256k business system
2x720k d/s d/d
FREE 9" monitor
FREE SC D100 120cps f/t
printer & cable
FREE SuperWriter w/p
FREE SuperCalc s/sheet
FREE SuperPlanner
manuals, MSDOS
FREE 5 discs & paper

Printers

£179 Mannesman T MT80+
SmithCorona FASTEXT 80cps
Shinwa CPA80 100cps
Epson RX80FT 100cps
Epson FX80 160cps
£180 SC D100 120cps
£259 Taxan 810 160cps/(27)
£260 Canon PW1080 160cps(27)
£260 SmithCorona D200
£360 SmithCorona D300 (WIDE)
CALL Epson LX100
£299 Juki 6100 20cps
£799 Olivetti DY450 45cps
£549 Olivetti DY250 25cps
Brother HR15 13cps
£209 QuenData 18cps
Canon LaserJet
HP LaserJet 500cps
HP ThinkJet 150cps (50db)

Crestmatt packages
may be reconfigured to
suit individual business
needs. We provide
**demonstration
support and
training;**
on-site maintenance
contracts are available

**CRESTMATT CHALLENGE YOU
TO FIND A BETTER DEAL**

Crestmatt Limited

67a York Street (Baker St)
London W1H 1PQ
01.402 1254/5
01.723 4699

export and
mail order

telex 265871 (MONREF G)
quote ref 81:DRG015
Monday Friday 9.30am-7
Saturday 10.30am-4pm
prices subject to change
without notice; goods
subject to availability
add VAT at 15%
to all prices

available with just one 1.2Mbyte disk drive, 512k of RAM, a keyboard and GW-Basic for £2675.

If you want to buy any hardware add-ons, these will be sold by SoftSel rather than by Kaypro direct.

Compaq Deskpro 286

Hardware

How about this specification for a modern desk-top micro: fast 8MHz 80286 processor, 2Mbytes of RAM, a 1.2Mbyte floppy disk, 30Mbyte hard disk and a 10Mbyte tape streamer — and all in a box smaller than the Kaypro 286i.

Unlike the Kaypro 286i, the Compaq Deskpro 286 bears little physical resemblance to the IBM PC/AT. It does, however, look very like the Deskpro, which is Compaq's IBM PC clone.

The Deskpro 286 can't be described as an attractive machine. The main casing is cream-painted metal with a plastic and rubber front panel, and various disk drives and streamers poke out of the front.

On the review machine, working from right to left, there is a full-height hard disk which looks like it should be removable but isn't, a half-height floppy disk drive, and a half-height micro tape streamer unit.

On the left is the keyboard-disabling lock which is a Yale-style lock that locks on the lid as well as disabling the keyboard. Finally on the front panel is a DIN socket for the keyboard connection.

The rear panel is just as boring as on the PC/AT but is laid out slightly differently. To the left is a power unit and on/off switch. In the middle are lots of ventilation slots, and to the right are the obligatory eight expansion plates. The Compaq also has a power output DIN socket designed specifically for the Compaq monitor which was supplied with the machine.

Of the expansion plates, two were visible in use: one for video output, and one for a parallel printer port and a cut-down RS232 port.

Getting inside the Compaq is more entertaining than getting into the Kaypro. The manual tells you to remove the three retaining screws, but forgets to tell you which of the eight screws on the back panel these are.

Removing the screws is fun. Compaq uses a special type of security screw which you really need a special screwdriver for. However, with a bit of effort, a flat-bladed screwdriver will do the job. After I had taken out the screws, I found that I had overlooked the special screwdriver supplied by Compaq!

When you have removed the lid, you can get at the inner workings of the Compaq. The immediate impression is

that it looks more like a cat's cradle of wires than the Kaypro; the second impression is of very stout engineering.

About three-quarters of the front of the Compaq is taken up by a very stout-looking cage designed to house the disk drives, streamers and hard disks, all mounted on substantial rubber isolation mountings. It's the first time I've seen it done in this way, and it does mean that your delicate hard disk and floppy disks are as well insulated from shock as possible.

Behind the disk cage is the fully-encased power supply unit with a large fan set in the top.

The design of the digital electronics is slightly different from that of the Kaypro or the PC/AT. The motherboard is quite small — about a third of the available floor area. The reason it is so small is that it only houses the main processor, the discrete logic and controller circuitry, and the expansion slots. Memory is on an expansion card.

Although there are eight expansion slots, one is behind the disk cage and therefore only suitable for a half-length board. All the memory and outside-world communication is handled by add-on cards.

Unlike the Kaypro, most of the chips on the Compaq motherboard are soldered directly to the PCB rather than socketed. The main processor is the Intel 80286 (as used on the PC/AT or the Kaypro). However, the clock is slightly different. If you boot the system under MS-DOS version 3.0, the system sets to 8MHz and then goes off to see if there are any expansion cards installed that don't like that speed. If there are, the system slows down to 6MHz for PC/AT compatibility.

The clock speed can also be set under user control. To slow it down you can either hold down the CTRL, ALT and / keys, or you can enter MODE SPEED=COM at the DOS 'A>' prompt. If you boot the system under MS-DOS version 2.11, the system sets to 6MHz.

Both the RAM and the ROM are housed in a full-length expansion card. The memory board on the review

machine was fully populated with 72 256kbit RAM chips giving a total of 2.2Mbytes.

In addition to the memory card, there were another three expansion cards installed in the review machine. One was a combined printer, RS232, floppy disk (1.2Mbyte and 360k) and tape streamer controller. Another was a hard disk controller, and the third was a display driver card. As it uses an extra card for memory, only four of the original eight expansion slots are available for use and one of these can only accommodate a half-length card.

While three-and-a-half slots will probably be OK for most people, some may find it restrictive, especially in multi-user mode.

The review machine was supplied with one 30Mbyte hard disk, one 1.2Mbyte floppy drive and a 10Mbyte tape streamer; other options are also available. All three worked well. The hard disk has a manual shipping lock to secure the read/write heads in place when you are moving the unit. Usually you run a program to park the heads out of harm's way rather than physically locking them; but the lock is probably safer as long as you remember to unlock the heads before you try to use the hard disk.

The floppy disk drive has a neat multi-coloured LED built in to show you which kind of disk it is accessing. If it is reading a 360k IBM PC disk, the LED glows red; if it is reading a 1.2 Mbyte AT floppy, the LED glows green.

The system is also nicely set up in that the operating system treats the one floppy disk drive as both drives A: and B:. This means that even though you only have one physical floppy drive, you can still run installation programs that assume you have two drives. The system prompts you to change disks.

The tape streamer is something of an oddity in a desk-top micro. In effect, a tape streamer is just a cassette of magnetic tape and is usually used for backing up hard disks. The great advantage of a tape streamer is its high capacity and speed, and until recently the disadvantages have been price and the size of streamer units.

The streamer is well-integrated into the Deskpro system. The system disk contains a utility which allows you to format the cartridge and transfer the contents of a disk to tape or *vice versa*. The only problem with the review system is that if the hard disk was filled with 30Mbyte of data, you would need three streamer cartridges to fully back it up. Having said that, it's still easier than using umpteen floppy disks.

The Compaq keyboard is slightly less deep than the PC/AT or the Kaypro. Although the layout of keys is the same as on the PC/AT, it still looks different.

The main qwerty typing area occu-

Benchmarks

	Kaypro	Compaq
BM1	0.6	0.4
BM2	2.0	1.5
BM3	4.2	3.1
BM4	4.4	3.3
BM5	4.7	3.5
BM6	8.4	6.1
BM7	12.7	9.4
BM8	12.9	9.0
Average	6.23	5.62

All timings in seconds. For a full listing of the Benchmark programs, see page 185, January issue.

KENDAL COMPUTING

TOTAL EXPERTISE UNDER ONE ROOF

THE APRICOT & SIRIUS MAINTENANCE PLAN YOU'VE BEEN WAITING FOR . . .

AT LAST!

AN EXCLUSIVE **LOW COST** MAINTENANCE PLAN THAT GIVES
YOU A TOTAL ON SITE RELIABLE SERVICE AND 100% PEACE OF MIND

CONTACT US **NOW** FOR A FAST NO OBLIGATION QUOTATION ON
YOUR SYSTEM. ASK FOR DAVID FULLER

01-366 1411

OUR OTHER DIVISIONS INCLUDE

- ★ **SOFTWARE SUPPORT.** Our specialists are available to offer comprehensive software support.
- ★ **SUPPLIES.** We can supply *ALL* the computer products you are ever likely to need, our service is fast, efficient and competitively priced.
- ★ **SECOND USER EQUIPMENT.** *ALL* makes of computer equipment bought and sold, attractive trades, all guaranteed.

MAIN CENTRES AT

LONDON

London Computer Centre
Kendal House
700 Great Cambridge Road,
Enfield, Middlesex EN1 3RU
Tel: 01-366 1411
Telex: 261774 KENDAL G

MANCHESTER

Manchester Computer
Centre
419 Barlow Moor Road
Chorlton-cum-Hardy
Manchester M21 2ER
Tel: 061-861 8877

WORCESTER

Worcester Computer
Centre
45 Foregate Street
Worcester
Tel: Worcester (0905) 612931

SWANLEY

Swanley Computer Centre
Unit 4, Park Road, Swanley,
Kent
Tel: 0322-64908

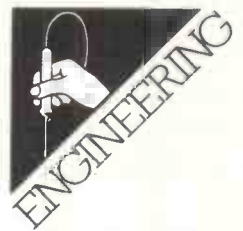



pies the centre of the keyboard. The 10 function keys are arranged vertically to the left, and the numeric keypad/editing keys are to the right.

The main difference is that the Compaq doesn't have the bank of LEDs in the top-right corner of the keyboard. Instead, the LEDs are built into the CAPS LOCK, NUM LOCK and SCROLL LOCK keys.

I liked the feel of the Compaq keyboard. It felt more substantial than the Kaypro unit, and the action of the keys was light but positive.

The Deskpro 286 was supplied with the standard Deskpro amber monitor. Although this is only a black and white unit, the display adaptor drives it as if it were a colour monitor so you can get Lotus 1-2-3 graphics, run Microsoft windows and do all the things you would expect to do on a colour system.

The monitor worked well and was flicker-free.

System software

Instead of using IBM's PC-DOS, the

Deskpro 286 uses its own version of MS-DOS version 3.0. However, as far as I could see, it was little different from PC-DOS version 3.0.

The review machine really showed up the shortcomings of PC MS-DOS version 3.0. The main problem with version 3.0 is that it doesn't make full use of the features offered by the 80286 processor. In fact, to all intents and purposes, it treats it as if it were a plain 8086.

One by-product of this approach is that the operating system can only access a maximum of 640k of RAM; the fact that the review machine has 2Mbytes of RAM makes no difference. If you type CHKDSK to ask MS-DOS how much RAM it has, it will say 640k, not 2Mbytes.

The problem occurs if the operating system can't see the extra RAM, as neither can the applications programs that run under it. The result of this was that I could load up Lotus 1-2-3, go to the last cell and still get an out-of-memory error! This will change, but only due to

companies such as Lotus rewriting their programs to make them look for extra RAM.

This meant that the only thing I could do with all that extra RAM was to use it as a RAM disk, but even here the operating system limits you because the maximum RAM disk size using the MS-DOS 'VDISK' utility is 512k. The only way out was to set up multiple RAM disks.

The effect of this is that until Microsoft gets around to enhancing MS-DOS, or Digital Research releases Concurrent DOS 286, there isn't much point in buying a PC or AT with more than 640k of RAM unless you're a RAM disk fan.

Applications software

In terms of PC/AT compatibility, my views on the Kaypro are equally applicable here. The Compaq ran everything I expected it to, including Microsoft's Windows.

Documentation

The documentation for the Compaq was the opposite of that of the Kaypro in every way. The Kaypro had a boxful of manuals, the Compaq had one manual. The Kaypro had a 32-page typed system manual, the Compaq had a professionally-printed manual with extensive use of black and white and colour photographs as illustrations.

Prices

At the time of writing, the pricing of the Deskpro 286 range hadn't been finalised, but the packaging has been decided. The Deskpro 286 will be available in two versions—the Model 1 and Model 2. The Model 1 will have 256k of RAM, one 1.2Mbyte AT-compatible floppy disk drive, a serial/parallel card, graphics card, keyboard and monitor.

The Model 2 will have 512k of RAM, one 1.2Mbyte floppy, a 30Mbyte hard disk, a parallel/serial card, graphics card, keyboard and monitor. The tape streamer is optional on all models.

Conclusion

Reviewing IBM-compatible machines can be difficult. The problem is that as all the machines are so similar, what would normally be minor points grow in importance as you try to differentiate between the machines.

This is the problem I face with these two machines. Both do their jobs adequately, but I can't help preferring the Compaq. And if you ask me why, it comes down to things like the way the disk drives on the Compaq are rubber-mounted!

I wouldn't buy an AT or compatible until companies get around to releasing decent software for these machines. What's the point of using all that power to emulate an IBM PC? **END**

Technical specifications: Kaypro 286i

Processor:	Intel 80286 running at 6MHz
RAM:	512k
ROM:	32k
Mass storage:	Single or twin 1.2Mbyte PC/AT-compatible 5¼in floppy disk drives. No hard disk at present
Keyboard:	84 keys, IBM PC/AT-compatible
Size:	21ins × 17.5ins × 6.5ins
I/O:	Eight expansion slots (six AT-compatible, two PC-compatible). Optional serial/parallel printer interface, colour graphics card
DOS:	MS-DOS version 2.11, buy your own PC-DOS version 3

Technical specifications: Compaq Deskpro 286

Processor:	Intel 80286, selectable 6MHz or 8MHz operation
ROM:	32k
RAM:	256k expandable to 8.2Mbytes
Mass storage:	1.2Mbyte AT-compatible floppy, optional 30Mbyte hard disk and 10Mbyte tape streamer
Keyboard:	84 keys, AT-compatible
Size:	19.75ins × 16.5ins × 6ins
I/O:	Eight expansion slots (six AT-compatible, two PC-compatible), mono/colour graphics card, serial/parallel card
DOS:	MS-DOS version 3.0

In perspective

Both the Kaypro 286i and the Compaq Deskpro 286 are the first of what will undoubtedly be a flood of IBM PC/AT clones. Neither machine pretends to offer significantly better value than the PC/AT; instead, they are trading on the availability problems of the AT.

Of the two, the Kaypro is visibly the most like the PC/AT. The Compaq offers the functionality while still retaining its own visual appeal.

Kaypro's approach of selling hardware add-ons such as graphics cards and hard disks through SoftSel is unusual. It is also a departure for SoftSel, which in the past has concentrated on software rather than hardware.

Compaq has much more of a reputation in the PC-compatible world than Kaypro, which is known primarily for its cheap 8-bit portables. On the whole, there isn't much to choose between either machine.

PEGASUS ACCOUNTING

Regarded by many accountants as the very best accounting software available. Pegasus comprises eight modules, most of which will operate alone or will work together in a totally integrated system. We have professional staff, in London and the Midlands, fully trained to install and support Pegasus. Prices and details on request. We are authorised Pegasus dealers.

COMPUTER-AIDED DESIGN

As specialist consultants in this field we can supply either software only or a total system configuration with full support. We are suppliers of AUTOCAD, DOODLE and a number of other CAD packages. The productivity benefits of CAD are enormous - the cost of a system is almost certainly much less than you would expect. In most cases our clients have found a system pays for itself within 3 to 12 months!

MULTISOFT ACCOUNTS

A system offering top-level functionality at a very reasonable price. Recent press reviews have highlighted Multisoft as one of the most powerful micro-based accounting systems currently available. We concur. Very impressive indeed! Please telephone for further information. We are officially appointed Multisoft dealers.

CHIT-CHAT

The new telecommunications package from Sagesoft which we feel represents outstanding value for money.

- ★ Micro-to-micro file transfer.
 - ★ Top of the range EMI Datatek modem.
 - ★ Free subscription to Telecom Gold (worth £100).
 - ★ Access to Viewdata and Prestel.
 - ★ Electronic mail, telecommunications and telex.
- List price £399 our price £325

BEST U.K. SOFTWARE PRICES?

TRISOFT LTD. 0629-3021

Whether you are seeking specialist advice or simply wish to buy your software at a competitive price we believe that Trisoft Ltd offers a service second to none. Apart from offering over 350 software packages, covering most machine formats, we are also dealers in ACT Apricot, Olivetti and North Star Dimension (IBM-compatible, multi-user), computers.

SPECIAL OFFERS
ALL PRICES QUOTED ARE FOR IBM/
APRICOT ONLY AND ARE FOR JULY/
AUGUST ONLY, OR WHILE STOCKS LAST.
FOR OTHER FORMATS PLEASE ENQUIRE

LOTUS 1-2-3	£289	MULTIMATE V.3.3	£265
FRAMEWORK V.1.1	£295	DR C COMPILER	£225
DBASE III V.1.1	£295	MULTIPLAN	£145
SUPERCALC II	£145	OPEN ACCESS	£325
DMS DELTA	£375	dBASE II	£225

★ **WORDSTAR PROFESSIONAL £399 £245** ★

*Please note that the above prices are exclusive of V.A.T.
*Carriage is charged at £3.00 + V.A.T.

SAGE ACCOUNTS £245
SAGE PLUS £485

*We offer probably the widest range of software in the UK. Please ask for a copy of our comprehensive price list.

*Local authority, government and European enquiries welcomed. Further discounts may be negotiated for large orders.

TRISOFT LTD

Crown Square, Matlock, Derbyshire DE4 3AT
Telephone 0629-3021

HARDWARE SERVICE

Please telephone for prices and details of our optional installation service. We supply:-

APRICOT

U.K.'s highest selling serious business micros; we supply the full range from the F1 to xi20s.

OLIVETTI

M21 and M24. In our opinion the Olivetti range offers the finest IBM-compatible, single-user hardware available.

NORTH STAR DIMENSION

The only 100% PC-compatible multi-user multi-processing system currently available. Will accept up to 12 work stations and runs all IBM "off-the-shelf" software. Tremendously cost effective as compared to IBM PC networks; up to 60MB central storage. Entry-level, 2 screen configuration with 15MB central storage only **£5875**, R.R.P.

SUPERCALC III

Here are just some of the features offered by Supercalc III Release 2 and why this program is likely to overtake Lotus 1-2-3 in total sales.

*Price includes direct telephone support from Sorcim/IUS. *Largest useable spreadsheet (up to 9999 rows and 127 columns) *Advanced memory manager. *8087 support for speed. *Over 500 built-in functions such as rate of return, net present value, average, random number generator, trigonometric functions etc. *Superb graphics including 8 font types, up to four charts per page and able to print all plotter colours. List price **£295** Our price **£199**

DISKS and BOOKS

We stock Sony, Dyan and 3M disks. Our prices are very competitive; for example 1 box of 10 Sony double-sided disks is £39.95 + V.A.T. + £1.00 carriage. We also sell computer books; please ask for a copy of our booklist.

IMPORTERS OF MICRO COMPUTER PRODUCTS

OFFERS:-

HARDWARE & ACCESSORIES

NEW PRODUCTS RELEASE

SOFTWARE

NEW SOFTWARE RELEASE

- IBM, Apple & C-64: Compatible Computers, Monitors, Printers, Modems, Hard Disks, FDD's, Interface Cards, Cables, Acoustic Couplers, Diskettes, etc
- JP Impact Dot Printers, X-Y Digital Plotters, 'Splend' Brand Computer glasses, IBM-PC Compatible Portable Computer, Macintosh Compatible FDD's etc...
- dBaseII, Lotus 1-2-3, etc... Over 2000 titles available for IBM, Apple, Mac. & C-64.
- MacIion, Thunderscan, Thunderclock, TimeBase, MacManager, Desk Topper, Timeworks, Jack 2, Enable, MacAttack, Prodata, Hacker, Wizard Wand, Trivia Adventure, etc...

Send for further details indicating interest and format.

KESTREL COMPUTERS
Suite No.5, 183 Drake St
Rochdale, Lancs.
Tel: 0706 342375 (9am-9pm)

UP TO 60% OFF SELECTED SOFTWARE
GUARANTEED LOWEST PRICES IN U.K.

LARGEST COMPUTER CENTRE in MANCHESTER

BBC, COMMODORE, MEMOTECH, SINCLAIR SHARP, SANYO, AMSTRAD, QL, EINSTEIN ADVANCE 86

COMPUTERS

Apricot F1E (256K + 315K disk)	£644.00
Apricot F1 (256K + 720K disk)	£918.00
Apricot PC (256K + 2 x 315K disk)	£1,493
Apricot PC (256K + 2 x 720K disk)	£1,679.00
Apricot Xi10 (256K + 10Mb Winchester)	£2,616.00
Apricot Xi10s (512K + 10Mb Winchester)	£3,047
Apricot Xi20 (512K + 20Mb Winchester)	£3,519.00
Apricot Xi20s (1Mb + 20Mb Winchester)	£3,979.00
Advance 86b	£799.00 + VAT
Ferranti 860	Promotional Price
BBC Model B	£339.95
BBC B + DFS	£420.00
New BBC Plus (64K + DFS)	£469.00
Amstrad 464 (Green)	£225.00
Amstrad 464 (Colour)	£325.00
Amstrad 644 (Green)	£332.00
Amstrad 664 (Colour)	£449.00
Sanyo 555	£799.00 + VAT
Spectrum Plus	£122.95

MONITORS (widest choice)

JVC, Sanyo, Microvitec, IBM, Ferguson, Taxan, Apricot.

PRINTERS

Canon PW1080	£319.00
Shinwa CPA80 (Centronic)	£219.95
Shinwa CPA80 (RS232)	£236.00
Epson RX80 FT	£289.00
Juki 6100	£388.00
Brother HR15	£395.00
Panasonic	£319.95
Smith-Corona (Fastext 80)	£165.00
Brother EP 44	£234.95
Brother M1009 (Centronic + RS232)	£195.95
Star SG10	—
Star SD15	—
Star SR15	—

DISK DRIVES

Opus, Pace, Cumuna, also WINCHESTER DRIVES for Sanyo, IBM, Advance and Apricot.

BBC ACCESSORIES

6502	£199.00
Z80 (2nd processor)	£359.00

COMPUTER FURNITURE IN STOCK

COMPUTER STATIONERY, DISKS, PLUGS, SOCKETS, CABLES, ETC. TELEPHONE ANSWERING MACHINES/CORDLESS PHONES: NOW IN STOCK

Wide range of books, software (Educational software specialist). Showroom, demonstration facility. Prices include VAT, all items available mail order. Personal Export scheme. Add £8 p&p if mail order. We accept Visa and Access. Export dealer enquiries welcome.



MIGHTY MICRO



SHERWOOD CENTRE
268 WILMSLOW ROAD
FALLOWFIELD, MANCHESTER
TEL: 061-224 8117

Real-life games

Do something useful with your micro and Microsoft Basic — simulate real-life situations such as cafes, car parks . . . you name it.

Computer simulation need not be a daunting task — it's rather like using a computer to play serious games. Instead of zapping aliens, you might like to simulate a car park, a cafe, a warehouse or even a factory. Ambitious types are advised to leave the universe until after lunch!

For simplicity, the examples here are written in Microsoft Basic. This is not the ideal language for simulation, but it's not too bad as long as you're careful. Regular readers of *PCW* should have their *PCW* Basic Converter Chart, and this will aid them, in translating the programs into whatever dialect they choose.

Following orders

Despite all the talk of heuristic programs and artificial intelligence (AI), one thing computers are extremely good at is following orders — providing, that is, the orders (or instructions) are unambiguous. There is no particular need for the orders to be given in the vaguely mathematical terms of a language like Basic: they could be expressed in any form which the computer is able to accept. Once recognised, they will be obeyed as long as it is within the power of the computer to do so.

Although this slavish adherence to rules might be irritating to the AI community, it is very useful for others. If the behaviour of a system can be completely and unambiguously described as a set of rules, then a computer could be programmed to mimic that system. Computer simulation is possible.

Consider, for example, a car park controlled by automatic entry and exit barriers. Suppose that a car is only allowed into the car park if the correct coinage is inserted in a slot, and if there is a parking space free. We could say

that the following happens to a car:

It arrives at the entrance and joins the queue if one exists.

When it reaches the barrier, the driver will put coins in the slot.

If there is a space available, the barrier will lift and the car will enter the park.

The driver will find the space and park the car.

The car remains in the park until the driver is ready to leave.

The car is driven to the exit barrier and joins a queue, if one exists.

When the car reaches the barrier, the barrier lifts and allows the car to leave.

As long as all cars obey these rules, we have a completely unambiguous description of what happens to the cars and spaces in the car park. It is then a simple matter to program a computer to obey the rules. To simulate such a system before it is built helps to ensure that it is being designed correctly.

Although computer simulation might not be much use for designing such a cheap and simple system as a car park, however, life is often not so kind. An army fighting a battle rarely gets a chance to fight a second time if it loses, so it makes sense to find an inexpensive and safe way of testing the various tactics. Battlefield simulations are not unknown in the military sphere.

To take another example, an airport authority may wish to know whether it's worth adding another runway. Simulated aircraft cause little damage when they fall from the simulated sky.

A computer simulation is useful when there is a need to carry out experiments on a system. The rules of the system are investigated and listed, and once agreed, they form the basis of a simulation model. The model is then programmed in an appropriate language and then the system is simulated

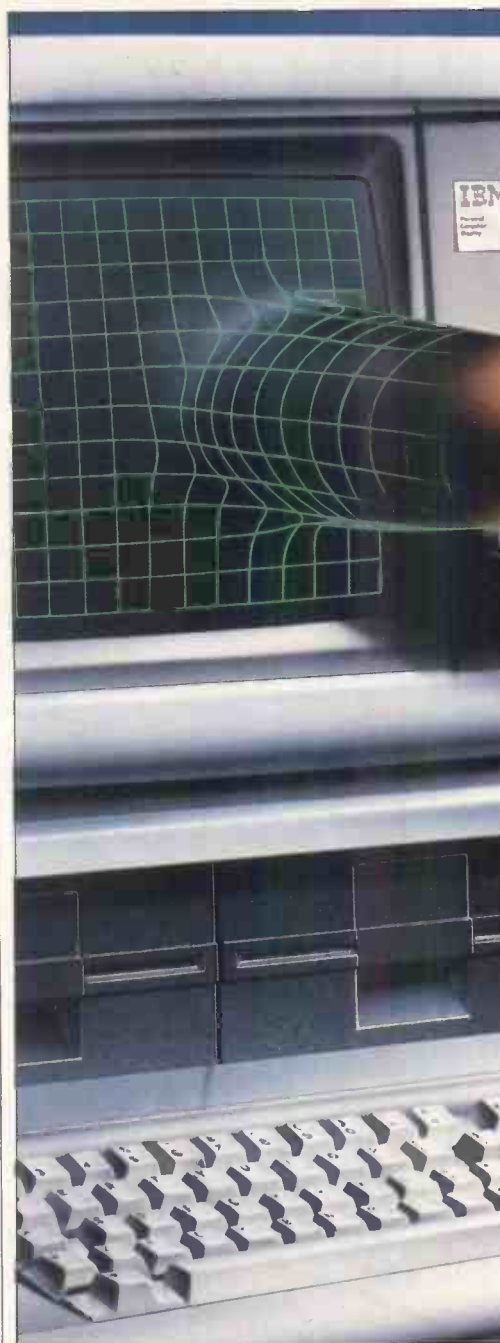

on a computer. At this stage, another advantage appears — speed. Using powerful computers and slick programming, a year on the system could be simulated in a few seconds of computer time (or minutes on a personal computer). This speed allows quite sophisticated experiments to be carried out.

Before going any further, I will introduce discrete event simulation (some people wrongly call this Monte Carlo simulation). As the name suggests, in these simulations we are concerned with discrete changes. In particular, we simulate time as if it moved forward in discrete, jerky amounts. In real life, time may be like an everflowing stream, but in our simulations we simplify things a bit. The question is: 'How large should these jumps be?' What we could do is move time from second to second, or minute to minute, or hour to hour, or even from year to year. If we are simulating a system where everything occurs at



regular intervals, then there is no problem. However, even timetabled systems such as railways rarely run exactly to schedule. More often, we need to simulate systems in which the activity occurs at irregular intervals.

Suppose we were simulating a car park by a commuter railway station. The activity in the car park will vary during the day. Most of the activity would occur in the morning and evening rush hours; there would be some activity during the intervening hours of daytime, but not much. During the night, there would be little or no activity.

Due to such variable activity being all too common, we use a variable time jump. Rather than deciding beforehand how big the jump should be, we let the computer program decide from the conditions within the simulation. We do this by making the program jump from state change to state change in the simulation. In the car park simulation, examples of such state changes might

be the arrival or departure of a car; these state changes are usually called 'system events'. If nothing important is happening at any time, the program just ignores that time and moves to the next event. Thus we have the name 'discrete event simulation'.

The other decision to be made is, what do we mean by important? We consider the entities that make up the system which we are simulating. In the car park these might be cars, drivers, attendants, barriers, parking spaces and trains. Whenever something significant happens to one of these, then we have a system event.

To begin producing such a discrete event simulation model, we must identify the entities of the system and note how they change state: that is, define the rules by which the system operates.

Working simulations

The programs have to be written in such

a way that they are easy to debug and validate, but being absolutely certain that your simulation program is bug-free is surprisingly difficult. It may be that the program only crashes when three cars arrive, two cars leave and a train comes late — all at the same time. More perversely, the program may not crash, but just start to do rather strange things which you may not notice! Any simulation analyst will tell you about one project or another in which, rather late on, he discovered that entities were mysteriously disappearing from the simulation. I heard of one simulation of an airport in which it was discovered that aircraft taking off seemed to disappear into a black hole at the end of the runway. Simulation programs *must* be well structured.

In the 1950's, Keith Tocher suggested a structure for simulation programs which would suit these problems. In those days, he was working with computers held together with string

PROGRAMMING

and sealing wax, and the highest-level programming was done in assembler or autocode. Tocher suggested that a discrete event simulation could operate with a repeated cycle of three phases called A, B and C. To understand what he suggested, it might help to imagine our program maintaining a diary of future events. We might know that a train will arrive at 8am, and regard this type of event as type 'B' as it is Bound to happen at a particular time.

Other events cannot be scheduled in

'Despite all the talk of heuristic programs and artificial intelligence, one thing computers are extremely good at is following orders — providing the orders are unambiguous . . .'

advance because they depend on what else goes on in the simulation. A car may only begin to park if a space is free. Such events are known as 'C' type as they depend on the Conditions in the simulation. To make things slightly confusing, Tocher called B and C 'activities', rather than 'events'. We'll just call them Bs and Cs.

When we come to program an example, you'll see that Bs and Cs are coded differently. The difference is that Cs have what is known as a 'test head' followed by actions, whereas Bs have only actions (Fig 1). In Fig 1, the B shown is one which might control the arrival of trains; the C is one governing the attempt by a car to park.

Tocher christened the diary entries needed to control the Bs and Cs 'time cells', giving one to each entity. Whenever a B can be reliably scheduled for an entity, we just place in the time cell the time when the B is due to occur. As the Cs depend on other things (that is Bs and Cs) we only need to see if these are possible whenever a B has happened, hence we get Tocher's three-phase approach:

A phase: examine all time cells. Pick out the B (or Bs) due next and move time to then. Hold time at that point.

B phase: execute all the Bs due at this new time.

C phase: now do all the Cs which are possible. Go back to the A phase until the simulation is over.

It wouldn't be sensible to do this for a large-scale simulation, but a simple way of implementing this A-B-C approach in Microsoft Basic is as follows. If there are n entities, create two vectors, each holding n items. Call the first vector TCELL() and the second

NEXTACT\$(). To find the time of the next state change of entity k, look in TCELL(k) and then look in NEXTACT\$(k) for the activity due then. Thus, for entity k, if the next state change is to engage in activity B1 at time 201, we should find that:

TCELL(k)=201 and NEXTACT\$(k)="B1".

If the entity is ready to engage in a C activity, then we can't say for certain which one it will be so we should find that:

NEXTACT\$(k)="C".

Joe's Caff

Many discrete event simulations are of queueing systems, so let's consider such an example here. Firstly, we'll look at the structure of the Bs and Cs. Next, we'll work out some Basic code which will simulate the system.

Imagine Joe's Caff. Joe has no helpers, probably because he's bad-tempered and pays low wages. Customers arrive at the Caff and must queue for service (regulars feel that 'service' may not be the right term for Joe's attitude). When they reach the front of the queue, Joe asks what they want and goes off to make it. When served, the customer pays and goes to a table to eat. Joe's food is never likely to make the *Good Food Guide*, so he has more table space than customers. Periodically, Joe goes to clear the dirty tables.

For some unknown reason, suppose that we wish to simulate this system. Firstly, what are the entities of the system? Surprisingly, in such systems it is often best to ignore the product for which the system exists, so in this case we'll ignore the food. We are left with customers, Joe, and tables and chairs. Given that the chairs are by the tables, we can just think about the chairs as representing both.

Next, what about the system states?

Customers arrive, queue for service, eat the food and leave. Joe is either idle, serving customers or cleaning tables. He never washes up! The chairs/tables are clean, in use, or dirty. Clearly some of these states coincide, we now think of the Bs and Cs that mark the state changes.

Customer service has a beginning and an end for each customer. It can only begin when a customer is waiting and Joe is idle (that is, ready to serve), therefore its start depends on these

'If the behaviour of a system can be completely and unambiguously described as a set of rules, then a computer could be programmed to mimic that system.'

conditions within the simulation. Thus, 'begin service' is a C. When the service starts we might be able to predict how long it will take, depending on what food is wanted, so its end is bound to occur at some time. Therefore, 'end service' is a B.

A customer can only begin to eat once served and then only if a clean chair/table is free, so 'begin eat' is a C. The time taken to eat the food can be calculated and 'end eat' is a B.

Suppose that Joe cleans the tables whenever he is free, and there are three or more dirty tables to be cleaned. 'Begin clean' depends on the conditions in the simulation and is a C. Using the same argument as before, 'end clean' is a B.

We might position ourselves with a stopwatch outside Joe's Caff and note when his customers arrive. The result-

EXAMPLE B: TRAIN ARRIVES

```
ACTIONS      Begin
              Note that train n has arrived
              Look up arrival time of train n+1
              Schedule arrival of train n+1
              End.
              Return to executive.
```

EXAMPLE C: BEGIN PARK CAR

```
Begin
IF car waiting AND IF space free
THEN   Begin
        Remove car from queue
        Occupy space
        Work out time for manoeuvre
        Schedule end of manoeuvre
        End
End.
Return to executive;
```

Fig 1 Program to show the different coding of B and C

```

1200 REM Schedule next activity
1210 TCELL(ENTITY)=DURATION+CLOCK
1220 NEXTACT$(ENTITY)=ACTIVITY$
1230 UTILISATION(ENTITY)=UTILISATION(ENTITY)+DURATION
1240 RETURN

```

Fig 2 Adding another subroutine

ing arrival data could be statistically analysed to show the typical intervals between successive customers, and we would then have a probability distribution or a histogram of the inter-arrival time. As customer 'n' arrives, we can take a sample from this probability distribution. Add this inter-arrival time to the current time, and we have the arrival time of customer n+1. As long as we know when one customer will arrive, we can say reliably when the next will come. As one customer actually arrives in the Caff, the next starts to arrive as if dragged along by his bootstraps by the predecessor. This bootstrapping approach allows us to treat the 'arrival' event as a B.

We now have the beginnings of a simulation model for Joe's Caff. It is very simple, but contains the skeleton of what could be a realistic simulation. The Bs and Cs are as follows:

B1: customer arrives — add customer to queue of those waiting for service. Note in diary when the next customer is bootstrapped to come.

B2: end cleaning chairs/tables — note the number of clean chairs/tables, set Joe idle.

B3: end service — note that customer is served, set Joe idle.

B4: end eat — note that chair/table is now dirty and customer gone.

C1: begin cleaning chairs/tables — if Joe is free and there are at least three dirty chairs/tables, then occupy Joe and note when this activity will end (that is schedule B2 in the diary).

C2: begin service — if Joe is free and there are customers waiting then occupy Joe, reduce queue by one and note when this activity will end (that is, schedule B3 in the diary).

C3: begin eat — if customer is served and clean table/chair available, then occupy chair/table and customer, schedule end of eating (that is, schedule B4 in the diary).

Program control

Having reduced Joe's Caff to a set of rules captured in four Bs and three Cs, we need to find some reliable way of programming its simulation. What we do is treat each B and C as an entirely separate subroutine ('procedure' in BBC Basic or Pascal), and these subroutines will not be allowed to communicate directly with each other. All such communication will be controlled by an 'executive', or control program.

The executive has two functions. Firstly, it must ensure that time in the simulation moves forward from event to event without missing any events (the A phase). Then it must ensure that the correct activity (that is, the correct Bs and Cs) occur at that time. It is the job

of the executive to ensure that a continual cycle of A-B-C occurs throughout the simulation. Using the two vectors TCELL() and NEXTACT\$() defined earlier, this turns out to be very simple. To illustrate it, we'll use Joe's Caff as an example.

To simulate the Caff, we have already specified four Bs and three Cs. We now need to consider the entities which are

needed for the simulation. To keep things simple, we can manage with just three classes of entity, as follows:

Joe: a unique individual.

Chairs/tables: a number, say 10, are available for customers.

An arrival machine: this deposits customers in the Caff at irregular intervals. For our purposes we can regard all customers as identical, at least until they reach the head of the queue.

We therefore have two vectors, TCELL() and NEXTACT\$(), each with 12 elements. As we're using Microsoft Basic, for convenience we'll give each entity a numeric label. Entity one can be

```

2000 REM CUSTOMER ARRIVES (B1)
2010 QUEUE=QUEUE+1:NUMARR=NUMARR+1
2020 ENTITY=NEWCUST:ACTIVITY$="B1":DURATION=5*RND(6)
2030 GOSUB 1200:REM Schedule next arrival
2040 PRINT "Customer ":NUMARR:" arrives, queue now ";QUEUE
2999 RETURN

3000 REM END CLEANING CHAIRS/TABLES
3010 DIRTY=DIRTY-TASK
3020 FOR I=1 TO TASK
3030 TABLESTATE(TABLETASK(I))=CLEAN:TABLETASK(I)=0
3040 NEXT I
3050 PRINT "Cleaning of ";TASK:" tables complete, ";DIRTY:" still
dirty"
3999 RETURN

4000 REM END SERVICE OF CUSTOMER (B3)
4010 SERVED=SERVED+1:WAITING=WAITING+1
4020 PRINT "End of service number ";SERVED
4999 RETURN

5000 REM END EAT (B4)
5010 FED=FED+1:DIRTY=DIRTY+1
5020 TABLESTATE(ENTDUE-2)=FILTHY
5030 PRINT "Table ";ENTDUE-2;" now dirty, ";DIRTY:" tables dirty"
5040 PRINT FED:" customers now finished"
5999 RETURN

12000 REM BEGIN CLEANING 3 OR MORE TABLES/CHAIRS (C1)
12010 REM Testhead
12020 IF NEXTACT$(JOE)<>"C" THEN RETURN
12030 IF DIRTY<3 THEN RETURN
12040 REM Establish list of tables to be cleaned
12050 TASK=0
12060 FOR I=1 TO NUMTABLES
12070 IF TABLESTATE(I)=FILTHY THEN TASK=TASK+1:TABLETASK(TASK)=I
12080 NEXT I
12090 ENTITY=JOE:ACTIVITY$="B2":DURATION=TASK
12100 GOSUB 1200:REM Schedule end of cleaning dirty tables
12110 PRINT "Joe starts to clean ";TASK:" dirty tables/chairs"
12999 RETURN

13000 REM BEGIN SERVICE (C2)
13010 REM Testhead
13020 IF NEXTACT$(JOE)<>"C" THEN RETURN
13030 IF DIRTY>=NUMTABLES THEN RETURN
13040 IF QUEUE<=0 THEN RETURN
13050 REM Actions
13060 ENTITY=JOE:ACTIVITY$="B3":DURATION=3*RND(6)
13070 GOSUB 1200:REM Schedule end of service
13080 PRINT "Joe starts to serve customer ";SERVED+1
13090 QUEUE=QUEUE-1
13999 RETURN

14000 REM BEGIN EATING (C3)
14010 REM Testhead
14020 IF WAITING<=0 THEN RETURN
14025 FOR TABLE=1 TO NUMTABLES
14030 IF TABLESTATE(TABLE)=FILTHY THEN 14070
14035 IF NEXTACT$(TABLE+2)<>"C" THEN 14070
14040 ENTITY=TABLE+2:DURATION=15*RND(6):ACTIVITY$="B4"
14050 GOSUB 1200:REM Schedule end of eating
14060 GOTO 14080
14070 NEXT TABLE:RETURN
14080 PRINT "Customer starts to eat at table/chair ";TABLE
14085 WAITING=WAITING-1
14999 RETURN

```

Fig 3 Bs, Cs, initialisation and finalisation

PROGRAMMING

the arrival machine, entity two can represent Joe, and entities three to 12 are the chairs/tables. Our executive program has to be structured as follows:

1) A phase: note the value of the minimum TCELL() whose entity has a B scheduled next in NEXTACT\$(). In Microsoft Basic, this simply means examining the first character of the string NEXTACT\$() for equality with B and then checking the value of TCELL(). This minimum time cell then tells us the next value of the simulation clock.

2) B phase: for each entity whose time cell is equal to this new clock value,

Any simulation analyst will tell you about one project or another in which . . . he discovered that entities were mysteriously disappearing from the simulation.'

do the B indicated by the string value in NEXTACT\$(). Do these Bs in whatever sequence is most convenient. Before each of the Bs, make sure that the NEXTACT\$() of the relevant entity is set to C: that is, the entity is free unless otherwise committed in the B.

3) C phase: now try each of the Cs in turn, repeating the attempts until no more Cs are executed.

In Microsoft Basic, the B and C phases are easiest to control by using the 'On X GOSUB' statement, where X is a key indicating which B or C is next.

For safety, avoid tampering directly with the TCELL() and NEXTACT\$() vectors from within the Bs or Cs. It is sensible to add another subroutine, as shown in Fig 2. Whenever we wish to reschedule an entity, we will do so via this subroutine. This minimises the risk of wrongly altering a time cell or the next activity indicated. We should never alter the simulation clock; this is stored as CLOCK (line 1210) and records the current simulation time.

Our simulation program finally has six sections as follows:

1) The executive: this is general and can be used for any discrete simulation.

2) The scheduling subroutine: again, this is general.

3) An initialisation section: this gives initial values to the variables in the program.

4) The Bs: each an independent subroutine.

5) The Cs: each an independent subroutine.

6) A finalisation section: this summarises the performance of the system

being simulated.

The Bs, Cs, initialisation and finalisation are shown in Fig 3 and described below.

B1 customer arrives: this is very simple. Line 2010 adds the new arrival to the queue and adds one to a counter for the number arrived so far. Lines 2020 and 2030 schedule the next arrival in something between 0 and 5 minutes time. Line 2040 provides screen display.

B2 end cleaning chairs tables: line 3010 reduces the number of tables still dirty. Lines 3020 to 3040 clear out the records that tell Joe which tables to clean. 3050 provides run time display.

B3 end service of customer: line 4010 adds 1 to counters showing how many customers have been served and how many are waiting for a table.

B4 end eat: in line 5010, 'fed' and 'dirty' are counters recording how many customers have been fed and how many tables are currently dirty. In line 5020, ENTDUE is a variable produced by the executive which shows which entity is causing this B to happen. As the chairs/tables are entities two to 12, ENTDUE-2 gives the number of the table just released. Its state is set to 'filthy'.

C1 begin cleaning tables: lines 12010 and 12020 are the test head of this C. If these tests are failed, then control returns to the executive which will pass on to C2. Line 12020 checks whether Joe is free; if he is, then a C will be indicated as his next activity. Line 12030 checks to ensure that three or more tables are dirty.

Lines 12040 to 12080 find which tables are dirty and lines 12090 and 12100 commit Joe to clean these tables. As it takes him one minute per table, he will finish cleaning them (B2) in 'task' minutes.

C2 begin service: this time there are three tests to pass. Line 13020 checks whether Joe is free; line 13030 makes sure that a clean chair/table is available; line 13040 sees if any customers are waiting to be served. If these tests are passed, lines 13060 and 13070 commit Joe to end this service in something between 0 and 3 minutes time. Line 13090 reduces the queue by one.

C3 begin eating: this is rather more complicated. It begins with a simple test in line 14020 to check that there are customers waiting for a chair/table. Lines 14025 to 14070 examine all the chairs/tables in turn. They search for the first free, clean table and return to the executive if none is found. The first such table is assigned to the waiting customer and the end of eating (B4) is scheduled for anything up to 15 minutes hence. Line 14085 reduces the number waiting by one.

Initialisation: in this program, the executive occupies lines 1000 to 1199

and the initialisation section comes before it. As you might expect, it merely establishes initial values for the variables of the program. Strictly, some of these are parameters, such as the number of tables/chairs and duration of simulation; others establish that all the tables are initially clean and that Joe is idle. For convenience, it might also set up the time that the first customer arrives. The executive takes over from the initialisation section.

Finalisation: this section provides a report of the performance of the system. For Joe's Caff, we might wish to know how many customers came, how

A computer simulation is useful when there is a need to carry out experiments on a system. The rules of the system are investigated . . . they form the basis of the simulation model.'

many were served and how many completed their meal. We also might need the percentage utilisation of all 12 entities. If you write your own executive to make this simulation work, you'll find that the customers could probably manage with, say, six tables. You'll also find that Joe is busy about 75 per cent of the time.

The execution starts the finalisation when the specified simulation duration is exceeded.

Graphics

Watching text scroll past as the simulation runs is boring, and is not a good way of communicating the status of the program. To make things more interesting, you could try adding some graphics, which is impossible in standard Microsoft Basic but possible in GW-Basic. All you do is allocate graphical attributes to each entity.

Depending on your graphics system, this can be quite simple or rather difficult. Typical graphical attributes are shape, colour, scale, rotation and x/y coordinates for each entity. As an entity is rescheduled or freed, its graphical attributes are updated. Then at each A phase, the screen is re-drawn. This is painfully slow in GW-Basic, but quite fast in other systems.

When you get to this level of ambitious simulation, perhaps you ought to abandon Basic altogether.

Mike Pidd is a lecturer in Operational Research at Lancaster University and author of Computer Simulation in Management Science, published by John Wiley. **END**

*** CUT PRICE MICROS ***

PLUS

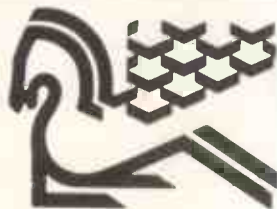

**PEGASUS
BUSINESS
SOFTWARE**

APRICOT MICROCOMPUTERS

ACT Xi 10 MEG £(VERY LOW!!)
 ACT Xi 5 MEG £(EVEN LOWER!!)
 ACT 2x720K £(LOWER THAN MAYFAIR)
 ACT 2x315K £(LOW-LO-LO)
 12" MONITORS AVAILABLE

THE PEGASUS SYSTEMS

SYSTEM 1

APRICOT WITH 2 x 720K PLUS 12" MONITOR
 PLUS SUPERWRITER WORDPROCESSING PROGRAM
 PLUS SUPERCALC FINANCIAL FORECASTING PROGRAM
 PLUS SUPERPLANNER ELECTRONIC DIARY AND
 CARDBOX SYSTEM

PLUS PEGASUS SALES ORDER PROCESSING/INVOICING
 PLUS PEGASUS SALES LEDGER
 PLUS PEGASUS PURCHASE LEDGER
 PLUS PEGASUS NOMINAL LEDGER

PLUS DATA CABLE TO LINK PRINTER TO COMPUTER
 PLUS 203.5" DISKS
 PLUS BROTHER HR 15 DAISY WHEEL QUALITY PRINTER
SYSTEM PRICE £2796.00

SYSTEM 2

APRICOT WITH 10 MEGABYTE HARD DISK DRIVE AND
 12" MONITOR
 WITH SUPERWRITER FOR WORD PROCESSING
 WITH SUPERCALC FINANCIAL FORECASTING
 SPREADSHEET
 WITH SUPERPLANNER ELECTRONIC DIARY SYSTEM

PLUS EPSON FX80 PRINTER
 PLUS DATA CABLE TO LINK PRINTER TO COMPUTER
 PLUS 103.5" DISKS
 PLUS 1 BOX OF FANFOLD PAPER

PLUS ANY 4 MODULES OF PEGASUS ACCOUNTING
 SOFTWARE

SYSTEM PRICE £3596.00

WE CAN
 RECONFIGURE ANY
 PACKAGE TO SUIT
 YOUR INDIVIDUAL
 NEEDS. WE PROVIDE
 HOT-LINE SUPPORT,
 SERVICE, DATA
 INSURANCE & ON-
 SITE MAINTENANCE

THE APRICOT SYSTEMS

APRICOT Xi 10 MEG
 SUPERWRITER
 SUPERCALC
 SUPER PLANNER
 BASIC/MS-DOS/CPM-86
 FX100 PRINTER & CABLE
 BOX OF DISKS
 BOX OF PAPER
£2800

APRICOT 2x720
 12" MONITOR
 SUPERWRITER
 SUPERCALC
 SUPER PLANNER
 ANY PRINTER
 WORTH UP TO £400
£1996

SOFTWARE - UP TO 30% DISCOUNTS

WORDSTAR
 FRIDAY
 DBASE II
 OPEN ACCESS

CARDBOX
 DBASE III
 AUTOCODE
 LOTUS 1-2-3

SYMPHONY
 TOUCH & GO TYPING TUTOR
 SUPERCALC III

SUPERCALC II
 MULTIPLAN
 FRAMEWORK

OUR FULL SOFTWARE RANGE IS FAR TOO LARGE TO INCLUDE HERE PLEASE
 CALL US FOR CURRENT PRICES ON ANY SOFTWARE PRODUCT

ALL ITEMS ARE FULLY SUPPORTED AND GUARANTEED. CALL NOW FOR FREE
 ADVICE FROM OUR APPLICATIONS EXPERT. TRAINING IS ALSO AVAILABLE ON
 ANY PROGRAM OR COMPUTER.

WE OFFER FREE TRAINING WITH ANY TOTAL PEGASUS SYSTEM BOUGHT
 FROM US. OUR SYSTEMS ARE SOLD ON AN INSTALLED AND WORKING BASIS.
 WE CAN DELIVER TO ANY PART OF THE U.K. OR COURIER TO ANY TRADING
 COUNTRY IN THE WORLD.
 VAT NOT INCLUDED IN ABOVE PRICES.

BUY RENT OR LEASE
 FROM THE PROFESSIONALS



We are authorised dealers for the above

TEL: 01-800 8182
78-82 KIRKTON ROAD
LONDON N15

MCS



Zero 2

The Zero 2 is an attempt to clarify the actual functions and uses of a robot in the light of the Hollywood misconception. Stephen Applebaum directs operations.

Robotics is one of those frequently misunderstood areas of computing where, thanks mainly to the work of over-imaginative film makers and science fiction writers, a subject has been popularised more through fantasy than fact, leaving people with a jaundiced view as to what robots are and what they are realistically capable of. Robin Bradbeer of Intergalactic Robots (IGR) hopes, therefore, that his new Zero 2 robot cum turtle will help clear the mist to some extent, and give BBC, Spectrum and Commodore 64 owners an opportunity to discover what robotics involves at a basic level, for a relatively small outlay.

At £99.95 for an assembled model (£79.95 in kit form) the Zero 2 should come within the reach of most micro users' budgets. For your money you get the robot, interface cable, power supply, software and operating manual. As the little beast is machine independent, it can be used with any computer supporting a serial interface provided you have the appropriate connecting cable. People who prefer to buy the kit can obtain it from Maplin, but they will only get the robot and four metres of cable; the reason being that IGR believes anyone wanting to build the Zero 2 will probably already have a 9v~12va psu and could certainly build the interface at a lower cost than buying it direct from them.

The Zero 2 qualifies as a robot by virtue of the fact that it can be programmed to do a variety of different tasks, mechanically or otherwise. This does not mean, however, that it will relieve you of any housework or put the cat out — far from it. In fact, the Zero 2's ability seems extremely limited when compared to R2-D2 or C3-PO, but you must remember that it is a cheap and very real device, not an electronic prop created by a film studio's dream factory.

Design

Designwise the Zero 2 looks like a computerised jellyfish, its clear plastic case giving a good view of its internal

workings. Inside the robot's shell is an aluminium chassis to which are attached three large stepper motors and a pcb. Two of the motors drive the device, each controlling a wheel in steps of half a millimetre, while the third raises and lowers a pen. Toward the front of Zero 2 is a 4 x 2½in pcb; this is the nerve centre of the machine. Not only does it include the firmware for communicating with the host computer, but also some nice little additions such as red and green turning lights (LEDs), a small hooter and a line follower.

A kind of complex simplicity is a major feature of Zero 2's design. Setting it up for use requires little more than having to plug the connecting cable into the micro's serial port at one end, and the robot's 'telephone' socket at the other. As the device does not take its power from the computer, a separate power supply is required which plugs into a small interface situated near the computer end of the connecting cable. When everything is linked together, you are ready to go.

In use

Communicating with Zero 2 can be done through Basic, machine code or Logo, but for most people, the easiest way to start will be with the bundled software.

A list processing program gives easy access to the robot's built-in features by allowing simple Logo-like instructions to be used to make Zero 2 perform a function. It is also possible to 'teach' the robot, say, a maze, using direct control from the computer keyboard or a joystick. This lets you guide the robot around the maze, place it back at the beginning, and then watch it go through the exact same procedure but this time unaided.

Also included is a series of machine code routines to interface the device to Logo. In the case of the Spectrum this means Sinclair Logo, and for the 64 it's Commodore's own Logo, while the BBC uses Logotron's implementation. At the time of writing Logotron had not

finished interfacing its package to IGR's robot, although it should be ready by the time you read this. Other Logo interfacing routines are planned, such as for the Atari and Apple micros.

Most of the software packaged with Zero 2 is fun to use, but on the whole is quite limited. The more ambitious user will soon become tired of the building program and will want to move onto something more complex. This will usually take the form of instructing the device in either Basic, Logo or machine code.

Each one of Zero 2's functions can be programmed by sending information through the computer's RS232 (RS423 on the BBC) to a specific address. As a serial port can function at different baud rates, the first part of any Basic program must set up parameters for sending data to the serial port at a required speed. There are many different addresses that can, and must be addressed to make the Zero 2 perform even a simple series of movements, but I'll only give a brief example here, as outlined in the machine's small and concise operating manual.

The following list shows a set of functions and their addresses:

Device	Address
Drive motors	0
Pen motor	1
Indicators	2

By sending a number between 0 and 15 to one of these addresses, the device at that location can be made to perform an action. In Basic, this is done by printing a byte containing information for both the address and data to the serial port. This takes the form: (byte value + 16) + data.

Each of the two motors driving Zero 2 can be controlled individually or simultaneously. The right-hand motor is controlled by a binary number between 0 and 3, the left-hand motor by the binary form of the numbers 0, 4, 8 and 12. To make either of the motors go backwards or forwards, these numbers must be sent in a specific order. All the other devices onboard the Zero 2 can be controlled in much the same way as the

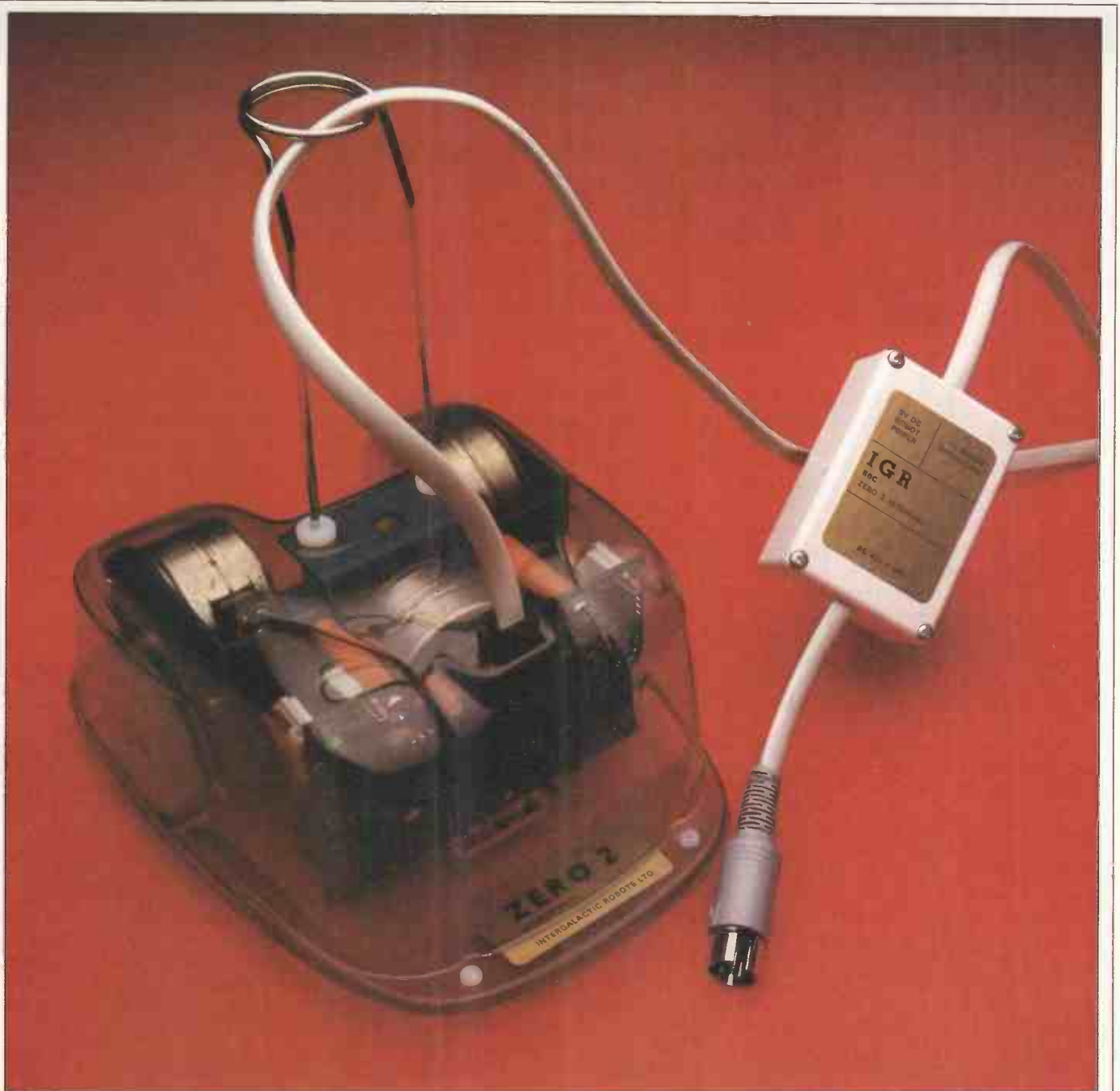

motors, although there are less long-winded methods outlined in the manual. For more advanced programs, there are a group of files which provide various machine code calls for use from within Basic.

Programming Zero 2 through Basic is fine, but a better, more enjoyable method is to use Logo. To complement the comprehensive Logo implementations already mentioned, IGR has added its own primitives for more precise control of Zero 2. The following commands are for the Spectrum, but those for the BBC should be very similar:

SETSCAL — allows the distance the robot moves for each unit in the Logo commands to be set.

ADJUST — compensates for slippage on different surfaces.

SETSPD — varies the robot's speed.

SETPEN — makes sure that the pen is at the limit of its range after a PENUP instruction.

SETHORN — allows the horn to be programmed from within Basic.

SETLEDS — allows the LEDs to be turned on and off from within Logo.

In its basic form, the Zero 2 is quite a powerful beast which can double as both a robot and a turtle, and is capable of running on a range of surfaces, from carpets to table-tops. However, IGR has plans to expand the system in a big way, and that means not only through extra software, but also several neat hardware add-ons.

On the pcb inside the Zero 2 is a small connector which allows further boards to be added. Two of IGR's major plans are to have a speech synthesis board/three-channel sound generator and an infra-red communications link. The latter will sit on top of the robot and should provide a distinct advantage over the umbilical cord which tends to get tangled while the Zero 2 is performing a circle, or whatever. A hole and edge detector, and an obstacle detector

are also planned, although IGR does not know as yet the order in which each add-on will become available.

The uses for Zero 2 are (cue cliché) only limited by the user's imagination. As far as the hardware is concerned, IGR has left slots and holes for hobbyists to expand the system themselves, as well as leaving some spare input/output connectors on the pcb for directly expanding the system.

Conclusion

The Zero 2 is an interesting development in the low end of the robotics markets. At just under £100 for the assembled device, IGR should not have any problem in attracting users in both the home and educational markets, especially the hobbyist who wants a robot to build and expand upon. **END**

For further details contact: Intergalactic Robots, Unit 208, Highbury Workshop, 22 Highbury Grove, London N5. Tel: (01) 359 2536.

New for old

WordStar 2000 is now available in the UK, but do its enhancements justify forsaking the tried and trusted WordStar? Kathy Lang examines how, and whether, to make the move.

Once upon a time, films about English country life almost always included a scene in which a housewife gives her husband's old, threadbare jacket to the church jumble sale, followed by another in which her husband surreptitiously retrieves it, muttering about people who want to throw away old friends. For someone who has been using one for a long time, a word processing package has a lot in common with that old jacket. While you may curse it from time to time, and bemoan its shortcomings, any threat to replace it with a new, smart, up-to-date package will encounter great resistance.

For a variety of reasons, word processing packages become part of one's lifestyle to an extent not matched by other types of computing tool, so for the tens of thousands of WordStar users in the UK, the news that WordStar 2000 is now available here may contain as much threat as promise. Certainly many current WordStar users will want to think very carefully about whether it is worth making the change to the new package. For those people, here are some indications as to how the two packages compare, and the merits and drawbacks of making the change. In

addition, there is some consideration of areas in which care will be most needed when converting document files from one package to the other.

The main differences of detail between the two are summarised in Fig 1, and subsequently discussed in greater depth. It is worth stressing initially, though, that whereas WordStar is supplied for a very wide range of computers, WordStar 2000 is at present only available for the IBM PC and close compatibles.

Moving around

The comparable commands for moving the cursor, and for moving text around the cursor, are shown in Fig 2. The major improvement is that WordStar 2000 allows direct movement to a particular page. The drawback is that, unlike WordStar, you cannot use the 'page down' feature (CTRL/C) to move the cursor down a screen when you are at the bottom of a document.

Deletion and insertion

Fig 3 shows the functions available in each package. In WordStar, a great cause of irritation is the way deletion of a single character works. In DOS, the

backspace key deletes the character behind the cursor, whereas in WordStar backspace works like the cursor-left arrow key; you must use the DEL key instead. WordStar 2000 remedies this so that deletion works in the same way as in DOS. WordStar 2000 also has single commands for deleting a sentence and a paragraph.

File and block

Most file and block operations work in a similar way in the two packages (see Fig 4). A major advantage of WordStar 2000 is the window facility, which allows you to display parts of two or three documents onscreen at once, and to copy text between them; this could help when constructing a document from existing text, for example in a 'standard paragraph' application.

The ability to set up abbreviations for longer, regularly used words or phrases is also a big step forward. WordStar 2000's ability to invoke the spelling checker while editing is another improvement, while the spelling checker itself — CorrectStar — is a great advance over the earlier SpellStar which most WordStar users have.

Formatting

A major problem for most WordStar users is its inability to 'remember' the settings of margins and tabs used with a document. In WordStar 2000, every margin and tab change is automatically recorded in a ruler which is set up by the package, stored with the document and activated as the cursor is moved through it. The manual equivalent in WordStar involves setting up a 'picture' of each ruler as a comment line and remembering to activate it yourself.

Another change in WordStar 2000 is reformatting after editing changes. In WordStar, you have to remember to do this (with CTRL/B); WordStar 2000 does it for you automatically (although not always perfectly — it is possible to fool it in some circumstances into leaving gaps). This may be an advantage — much depends on how often you edit from a printed draft, as in that case automatic reformatting means that once one change has been made in a paragraph, subsequent lines do not match the format of the printed draft.

Improved facilities

- Undo
- Stored rulers, tabs and indents
- Windows — especially good for repeated text
- Lots of extra function keys
- Abbreviations
- More direct cursor movement
- Arithmetic
- Column sorting
- DOS directories usable through PATH command
- Automatic reformatting
- Emphasis shown onscreen
- Excellent onscreen help
- Better footer and header features
- Footnotes
- Conversion to and from WordStar

Drawbacks

- Major changes to control keys
- Reduced flexibility with line height and pitch
- Mismatch between ruler and text on 12-pitch documents
- No justification onscreen (although line endings are correct)
- No indexing yet

Fig 1 WordStar 2000 for WordStar users



Lots Of Extra
Function Keys

Major
Change To
Control Keys

Document
Windows...

Especially
Good For
Repeated
Text

No
Indexing
Yet

No
Justification...

... on
Screen

Better
Header...

... and
Footer
Features

Illustration by David Simmonds

Move Cursor

Description	WordStar	WordStar 2000	Command Name
Right one character	^D or →	^D or →	
Left one character	^S or ←	^S or ←	
Up one line	^E or ↑	^E or ↑	
Down one line	^X or ↓	^X or ↓	
Right one word	^F	^F or →	
Left one word	^A	^A or ←	
To top of screen	^QE or Home	^CH or Home	Cursor Home
To bottom of screen	^QX or End	^CX or End	Cursor bottom left window
To top of file	^QR	^CB	Cursor Beginning
To end of file	^QC	^CE	Cursor End
To right end of line	^QD	^CR	Cursor Right side of line
To left end of line	^QS	^CL	Cursor Left side of line
To top of block	^QB	^CA	Cursor to block beginning
To end of block	^QK	^CZ	Cursor to block end
To start of last find	^QV	^CO	Cursor to Old block position
Find, replace text again	^L	^N	Next locate
To marker 0-9	^Q0 - ^Q9	^C0 - ^C9	Cursor to marker

WordStar 2000 Commands Not in WordStar

^CN #	Cursor Note number
^CP #	Cursor Page number
^CT	Cursor To character
^CW	Cursor Window

Move Screen

Description	WordStar	WordStar 2000	Command Name
Up one line	^W	^W	
Down one line	^Z	^Z	
Up one screen	^R or PgUp	^CU or PgUp	Cursor Up
Down one screen	^C or PgDn	^CD or PgDn	Cursor Down

Fig 2

Delete and Insert

Description	WordStar	WordStar 2000	Command Name
Delete character	^G	^RC or Del	Remove Character
Delete character left	Del	Backspace	
Delete word	^T	^RW	Remove Word
Delete line	^Y	^RE	Remove Entire line
Delete to end of line	^QY	^RR	Remove Right side of line
Delete to beginning of line	^Q Del	^RL	Remove Left side of line
Delete a block	^KY	^RB	Remove Block
Insert On / Off	^V or Ins	^OO or Ins	Option Overtyping
Insert carriage return	^N	^CI	Cursor Insert a line

WordStar 2000 Commands Not in WordStar

^RS	Remove Sentence
^RP	Remove Paragraph
^RT	Remove To character
^U	Undo last removed text

Find and Replace

Description	WordStar	WordStar 2000	Command Name
Find text	^QF	^L	Locate text
Find and replace text	^QA	^L	Locate and replace text
Find/replace text again	^L	^N	Next locate

Fig 3

WordStar 2000 does not, in any case, show text justified on the screen, but WordStar does.

Some other comparisons are shown in Fig 5, while others are considered under the next heading. A related change is the display of formatting controls, which can be hidden or displayed at will in WordStar 2000, to make it easier both to concentrate on the edited text when necessary, and to check formatting before printing. This checking is aided by WordStar 2000's

extensive use of colour for those whose equipment allows them to exploit it.

The printed page

A major difference between the two is the use in WordStar 2000 of a format file to specify the major aspects of page layout, such as page length, header and footer margins, and so on. This makes it easier to set up a single format specification for a whole group of documents. In addition, you can change some page layout parameters within the text;

of these, the most notable is line height as WordStar 2000 can take account of such changes in displaying page breaks onscreen. (WordStar allows you to change line height at any time, but cannot show page breaks correctly if you do.)

For users with standard printing requirements, WordStar 2000's method of setting up line height and character width through a format file or embedded commands will make life much easier. Unfortunately only a limited range of options is provided: text can be printed in 10, 12 or 15 pitch or proportionally spaced, while lines may be printed 2, 3, 4, 6 or 8 to the inch. This contrasts with the greater flexibility of WordStar, which gives access to the full capability of many letter-quality printers to offer character widths measured in 120ths of an inch, and line heights in 48ths of an inch. Many people will regard this as a small price to pay for the convenience of the format file approach (although this need not have precluded offering greater flexibility to those who need it), but if you have non-standard requirements you should check that WordStar 2000 can meet them.

Another distinction affects only those who use a character pitch other than 10. WordStar 2000 sets up its rulers in terms of tenths of an inch rather than characters per inch. In order to get, say, documents to be printed in 12-pitch to appear correctly, you must specify 12-pitch in the format file and then set up the ruler in terms of the text width in inches, assuming 10 characters per inch. Therefore, whereas in WordStar the text always appears in confirmation with the ruler line, in WordStar 2000, when typing 12-pitch documents, the text is displayed extending beyond the ruler line. In addition, there are some character positions in which tabs cannot be set as only 10 are available per inch. This won't be a problem if you always use 10-pitch, and you may not mind even if you frequently use 12-pitch, but those who are thinking of changing would be well advised to see the problem for themselves before deciding. And if you use tabs a lot, see the system used to type and print a table using 12-pitch.

A novel feature of WordStar 2000 is its Typewriter mode, which echoes directly onto the printer what is typed at the keyboard without the need for intermediate storage. The main use of this feature is for envelopes as it is then easier to line up the envelope correctly in the printer before the address is printed, nor do you have to save a file containing the address purely for this purpose.

Emphasis of text is handled in a similar way in both packages, with two major exceptions. Firstly, WordStar 2000 shows emphasis in a form which

File and Block Operations

Description	WordStar	WordStar 2000	Command Name
Column mode On, Off	KN	BV	Block Vertical
Mark, unmark block beginning	KB	BB	Block Begin
Mark/unmark block end	KK	BE	Block End
Hide, show marked block	KH	BD	Block Display
Copy block	KC	BC	Block Copy
Delete block	KY	BR	Block Remove
Move block	KV	BM	Block Move
Write block into another file	KW	BW	Block Write to file
Read file into document	KR	BI	Block Insert a file
Set remove marker 0-9	K0-9	CM0-9	Cursor Marker set 0-9

WordStar 2000 Commands Not in WordStar

BA	Block Arithmetic
BS	Block Sort

Save Files

Description	WordStar	WordStar 2000	Command Name
Save and resume edit	KS	QC	Quit and Continue
Save and return to Opening Menu	KD	QS	Quit and Save
Abandon file without saving	KQ	QA	Quit and Abandon

WordStar 2000 Commands Not in WordStar

QP	Quit and Print
----	----------------

Miscellaneous

Description	WordStar	WordStar 2000	Command Name
Set help level	JH	GG	Set menu display level
Repeat following command or character	QQ	OR	Option Repeat next key
Interrupt command	U	Esc	
Get help	J	G	Get help

WordStar 2000 Commands Not in WordStar

OS	Option Spelling check
OM	Option MailMerge commands

Fig 4

Format

Description	WordStar	WordStar 2000	Command Name
Paragraph tab	OG	TI	Tabs and margins In left
Center text	OC	OC	Option Center
Set left margin	OL	TL	Tabs and margins Left
Set right margin	OR	TR	Tabs and margins Right
Set margins and tabs from text line	OF	automatic	
Set tabs	OI	TS	Tabs and margins Set tabs
Clear tabs	ON	TC	Tabs and margins Clear tabs
Justification On/Off	OJ	OJ	Option Justify
Set line spacing	OS	Format or PH	Print Height
Page break display On/Off	OP		
Ruler display On/Off	OT	on in formatted files	
Word wrap On/Off	OW	off in unformatted files	
Print control display On/Off	OD	OD	Option Display
Hyphen help On/Off	OH	Format	
Soft hyphen entry On/Off	OE	O-	Option - (hyphen)
Re-form paragraph	B	automatic	

WordStar 2000 Commands Not in WordStar

ON	Option Note (footnote)
OW	Option Window
TB	Tabs and margins Both margins in
TD	Tabs and margins Decimal tab stop
TO	Tabs and margins Out left
TU	Tabs and margins Undo all indentation

Fig 5

does not affect formatting (no more embedded CTRL/Bs) and which is much easier to check to ensure there are no unmatched emphasis brackets. Secondly, if you really want to go on using underlining (despite the proven difficulty of reading underlined text), then WordStar 2000 will underline spaces for you if you wish (no more CTRL/POs between words to be underlined). That improvement went down very well in the US, so I'm told — one punter went so far as to applaud loudly when that feature was announced!

WordStar 2000 in use

A major drawback for most WordStar users will be the drastic changes made in the use of function keys and commands. Figs 2 to 7 show the correspondence between WordStar 2000 and WordStar commands, and from them it should be plain how great the changes are. As the keyboard implementation can be changed via the installation program, it would be possible to come close to emulating WordStar, but the absence of any ability to change the corresponding help features would make that a hazardous undertaking. For most people, the answer will be to grit one's teeth and make the change. In many respects, it will then become quicker and easier to use the word processor as there are more function keys. (The function key implementation is not shown in the figures, but most of the frequently used keys are available via the function key pad on the IBM PC, either alone or together with SHIFT, ALT or CTRL.) For those who prefer to use control key combinations, there are some circumstances where WordStar 2000 uses more keystrokes to do the corresponding operation.

For those of us who like, or think they would like, colour word processing, the greater flexibility of WordStar 2000 in this respect is a distinct advantage. In WordStar it is possible to use different colours for text, background and menus, but in WordStar 2000 the possibilities are much more extensive. Some people will regard that as a frill, but when you have tried it for a while it quickly becomes almost a necessity.

Converting files

WordStar 2000 has an option for converting WordStar document files to its own format, and for converting WordStar 2000 files to WordStar format. It is hardly surprising that this conversion is not complete, as many WordStar 2000 features are not available in WordStar, or are provided differently. Where conversion is impossible, the program will, where possible, insert comments to warn you, using the COMMENT feature in WordStar 2000 and the IG command in WordStar.

There are two main problem areas to watch out for. The conversion program cannot provide an appropriate format

IN BUSINESS

file to correspond with dot commands in your WordStar file, so once-per-document commands such as page offset (.PO) and page length (.PL) cannot be translated in that direction. A warning is given through the COMMENT facility. Despite the fact that WordStar 2000 does allow you to change line spacing and character pitch within a document, these commands are not translated as the mapping between the two sets of commands is incomplete. (For example, WordStar allows you to set line heights for which there is no direct equivalent in WordStar 2000, and WordStar 2000 combines specifying character pitch with font name, unlike WordStar.)

Secondly, parameters which are interactively changed in WordStar, where the changes are not recorded with the document, cause problems in both directions, as when coming from WordStar the program cannot detect the options used, and when translating from WordStar 2000 there are no corresponding recorded options in WordStar to set up. These problems apply to such options as justification (set during editing by CTRL/OJ in WordStar) and hyphen-help (set by CTRL/OH in WordStar). They also affect the use of rulers, as in WordStar the 'comment' rulers are simply a reminder rather than a feature. For this second class of commands which cannot be converted, you will be given warning when translating from WordStar 2000 to WordStar but not in the reverse direction, as WordStar does not record these options in the stored document file.

Conclusion

WordStar 2000 is in many respects a more powerful package than WordStar, and should be easier to use when you have become accustomed to the differences. On the other hand, there are some areas in which WordStar retains a greater flexibility, notably over character pitch and line spacing. The pitch problem with WordStar 2000 should be seriously considered if you frequently use character widths other than 10.

As usual, there is no substitute for trying the package out for yourself to see how you like it. With the pointers in this article, and your own knowledge both of the weaknesses and the strengths of WordStar as they affect your word processing needs, it should be possible to construct a reasonable 'road test' to take with you to the demonstration.

WordStar 2000 is supplied by MicroPro Ltd (tel: (01) 879 1122), and costs £440 (or £200 as an upgrade from WordStar). The minimum system for operation is a 256k IBM PC with two 320k disk drives.

END

Opening Menu Commands

Description	WordStar	WordStar 2000	Command Name
Change logged disk drive	L	D	Directory/drive
File directory On/Off	F	V	View directory
Set help level	H	GG	Set menu display level
Open a document file	D	E	Edit/create a document
Open a non-document file	N	E unformatted	Edit/create a document
Print a file	P	P	Print a file
Rename a file	E	M	Move/rename a file
Copy a file	O	C	Copy a file
Delete a file	Y	R	Remove a file
Exit to system	X	Q	Quit
Run CorrectStar	S	S	Spelling check

WordStar 2000 Commands Not in WordStar

F	Format design
K	Key glossary
T	Typewriter mode
Return	Use highlighted name as answer
T	Transfer name to answer line

Fig 6

Design the Printed Page

Description	WordStar	WordStar 2000	Command Name
Boldface	PB	PB	Print Boldface
Double strike	PD	PE	Print Emphasis
Underline	PS	PU	Print Underline
Strikeout	PX	PS	Print Strikeout
Subscript	PV	P-	Print Subscript
Superscript	PT	P+	Print Superscript
Strikeover	PH	PO	Print Overstrike
Nonbreak space	PO	PW	Print Word grouping
Strikeover line	P Return	PN	Print No new line
Alternate pitch	PA	PF	Print Font
Standard pitch	PN	PF	Print Font
Print pause	PC	PP	Print Pause
Ribbon color change	PY	PC	Print Color

WordStar 2000 Commands Not in WordStar

PF	Print Font
PT	Print Tray

Dot Commands

Description	WordStar	WordStar 2000	Command Name
Page offset, left margin	.PO	Format	
Character width	.CW	PF	Print Font
Comment	.IG or .	OU	Option Unprinted comment
Conditional page	.CP	OK	Option Keep lines together
Footing	.FO	OF	Option Footer
Heading	.HE	OH	Option Header
Footing margin	.FM	OF	Option Footer
Heading margin	.HM	OH	Option Header
Line height	.LH	Format or PH	Print Height
Margin at top	.MT	Format	
Margin at bottom	.MB	Format	
New page	.PA	OP	Option Page break
Omit page number	.OP	Format	
Page number	.PN	Format or OA	Option Assign page number
Page number column	.PC	Format	
Subscript, superscript roll	.SR	Format	
Paper length	.PL	Format	
Display message	.DM	OMM	Message
Define file	.DF	OMS	Select data file
Read variables	.RV	OML	Load data
Ask for variables	.AV	OMA	Ask for variable
Set variables	.SV	OMU	Use value for variable
File insert	.FI	OMI	Insert document
Repeat	.RP	OMR	Repeat
Conditional command	.IF	OMC	Condition
End command	.EF	OME	End condition

WordStar 2000 Commands Not in WordStar

OMN	Next copy
OMO	Otherwise

Fig 7

VIZAWRITE PC WORD PROCESSING

VIZAWRITE is probably the easiest business program that you will ever use!!

Right from the start, just type onto the screen and your words are instantly laid out on the page.

Just like a professional typist, VIZAWRITE knows when to end each line so that pages are produced with neat margins, inset paragraphs and perfectly lined up tabulations.

Now you can concentrate on what you're typing, not how to type. Documents take on a new look of professionalism. Produce memos, lists, letters and complete reports with incomparable speed and ease.

VIZAWRITE can also proof-read your work, excellent at picking out those 'juggled' words that get typed when the phone rings.

Document statistics, how many words you've typed, VIZAWRITE shows you — instantly.

VIZAWRITE is so easy to use, THE TIMES featured it again and again in no less than three separate articles on word processing for newcomers.

We've even included some of the latest software 'fashions', such as WINDOWS to view several documents at once, such as PULL DOWN MENUS that assist command selection, such as on-screen HELP if you can't find the manual!!... and much more.

VIZAWRITE is an extremely advanced word processing package with powerful layout and filing commands, fully integrated spelling checker and easy to use mail shot system.

Remember that VIZAWRITE has achieved an ease of use that you won't find in any specification.

It's intuitive, simple and fast.

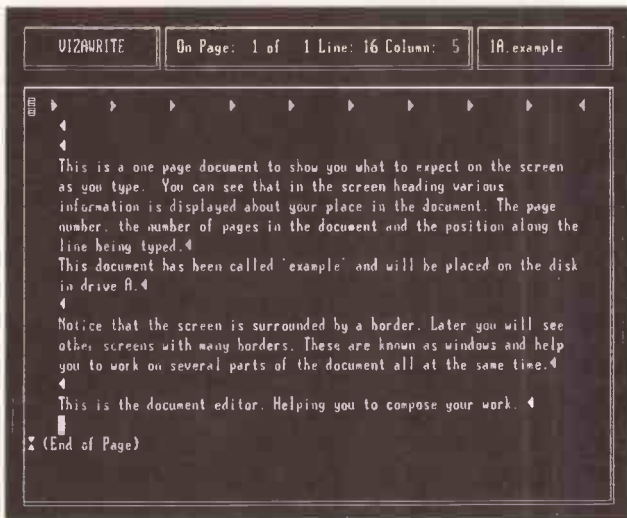

The Document Editor Screen

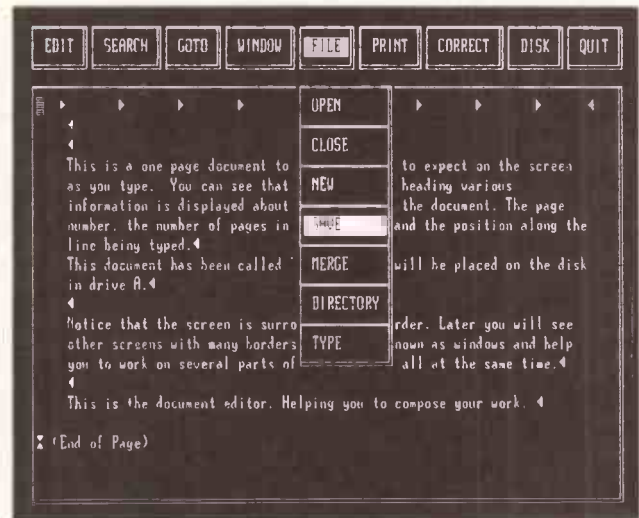

The Command Menu

VIZA SOFTWARE

Call us now, or fill in the coupon for more details.

VIZA SOFTWARE LTD.
Chatham House, 14 New Road,
Chatham, Kent ME4 4QR.
Telephone: (0634) 45002



Please send me further details about VIZAWRITE PC and the name of my nearest dealer.

Name _____

Company _____

Address _____

Tel. _____

PCW8-85



SCREENTEST

Paperback Writer

Paperback Writer may be one of the cheapest word processing packages around, but does it provide a full text editing service for the IBM PC user? Simon Craven weighs up price against performance.

Paperback Writer is a simple, straightforward text editing/word processing package with a big difference — the price. The IBM PC user normally expects to pay between £100 and £500 for word processing software, depending on the facilities required, but Paperback Writer retails in the UK at £33.80. This puts it in the same price range as quite a few packages written for home computers, many of which are completely unsuitable for serious use.

At this price level it is hard to take any IBM PC program seriously, but Adam Osborne, returning to the limelight with Paperback Software, intends to publish a wide range of serious business software for the IBM PC and compatibles, and talks with a perfectly straight face about selling software at prices related to the cost of production, not some artificial 'perceived value'.

This is all very well in theory, but if the £30 software turns out to be only one tenth as good as a £300 alternative, you will end up having to dig deeper into your pocket than you expected. Paperback Writer can't possibly be all things to all men, and fortunately it doesn't try. Rather than attempting to include all the facilities of a full-blown WordStar rival, cutting down on the power and usefulness of each module to keep it cheap and simple, Paperback Writer takes the attitude that not many people ever use more than half the facilities of sophisticated programs anyway. It dispenses with spelling checkers, word counters, mailmerge routines and other advanced features, leaving a core of features which work well and which should satisfy the requirements of many PC users.

The packaging of Paperback Writer is as unconventional as its price. Instead of the usual bulky ring binder with its loose-leaf pages, the package is a neat

paperback book. The back cover is made of very thick cardboard, and is hollow. A small panel tears out to reveal the diskette lurking inside in a foil bag. The 100 pages of text include a reference guide and a brief tutorial.

Running Paperback Writer for the

'... Paperback Writer takes the attitude that not many people ever use more than half the facilities of sophisticated programs anyway.'

first time is much easier than with more complicated packages. A choice of two installation programs lets you set up the software to run using either a floppy or hard disk as the primary storage medium, and lets you install DOS on the master disk so you can boot the system directly from just one disk. Printer installation is not included as the only special printing effects allowed by the editor are bold and underlined printing, and Paperback Software expects you to have a printer capable of those simple effects. All the program needs to know is the port your printer is attached to, and whether you have a colour display.

Installing Paperback Writer on the hard disk is a little more involved. This process makes C the default drive for text files, and it is possible to copy the Paperback Writer program files over to the hard disk to improve speed during the few disk accesses made by the software. Unfortunately, just copying the files to the hard disk does not mean that the original floppy disk becomes redundant. Surprisingly, the distribu-

tion disk contains a copy-protection scheme despite the low cost of the software. It would be hardly worth anyone's time to pirate a copy of this program, especially as any unofficial users would have to do without the documentation. Nevertheless, a software key is incorporated on the original disk, and no matter what disk or drive the software is running on, it looks at drive A to check the key at random intervals. If the original disk is not there the whole thing bombs out, losing any unsaved work into the bargain.

If the original disk meets its Waterloo at the hands of a cup of coffee or the household cat, you lose the ability to run the software. On the user registration form of the US edition, there is an invitation to buy a spare copy for \$5 against the day when your original gets chewed up or just plain worn out. A similar scheme will be available for users in this country, where the package is being distributed by Softsel.

Setting up

When you start up Paperback Writer, the first thing you see is a menu offering three options — Directory, Editor and Quit. Selection is made by moving an inverse video box from one word to another with the left and right cursor keys, and hitting RETURN when appropriate.

The Editor option first makes you declare a filename, using any drive, filename and extender within the normal MS-DOS/PC-DOS restrictions. If you do use extenders, it is wise to make sure that the extender isn't the only thing distinguishing one filename from another. Like WordStar, Paperback Writer takes the last version of an updated file and holds it on disk as a *.BAK file, so if you make changes to a file called TEST.PCW and then edit a file

called TEST.SPC, the TEST.BAK file created by the latter will overwrite the back-up of the earlier file.

When you type in the filename it is opened on disk, or created if no previous file of that name can be found.

The main editing screen is clear and uncluttered. A status line at the top of the display shows the current filename, and a line at the bottom shows the state of on/off toggles for boldface, underlining, insert/overwrite, and document or non-document mode. Document mode is set to *on* for writing ordinary text such as letters or articles, and set to *off* for editing program source files, which do not benefit from the insertion of printer control codes. In non-document mode, automatic wordwrap, justification, centring and paragraph reformatting are all disabled.

Below the lower status line are highlighted boxes containing the definitions of the PC's eight function keys. Some of the function keys have up to four different definitions, depending on whether they are used alone or in conjunction with SHIFT, CTRL or ALT. The legends in the highlighted boxes automatically change as appropriate when you press the ALT or SHIFT keys. Typing in a few lines reveals that with Paperback Writer, the correlation between screen appearance and printed version is not quite perfect. The left and right margins are faithfully reproduced onscreen, together with tabulations (which can be set at up to 20 stops along a line). The maximum document width is 132 characters, with automatic horizontal scrolling for widths in excess of the 80 characters that the screen can display at any one time.

Normally, anyone requiring a 132-column document would find it easier to write it in 80 columns and then carry out a global reformat upon completion.

When justification is selected it is reproduced onscreen, as are underlining and boldface. However, line spacing is selected at the print stage so does not appear onscreen.

The plain, unshifted function keys are used for functions you are likely to use all the time, such as the mode toggles already mentioned. Others include the setting of left and right margins, line centring, forcing a page break, and a WordStar-like paragraph reformat which shuffles text back into the appropriate margins after it has been disturbed by additions or deletions. One function key is devoted to a help facility which displays an explanation onscreen of any function key command. Oddly, the PRINT command is included as the final function key command; it would have been more conventional to put this facility on the opening menu. As it is, background printing is not possible.

Using the CONTROL key with a function key gives you one of the block commands. The start and finish of a block of text are marked with CTRL-F3

and CTRL-F4 (though logically, there really only needs to be one marker key, with the selected block being defined as the space between two markers). CTRL-F5 cancels a block selection. You can copy, move or delete a block, or change the whole thing to any permutation of bold and underlined text, and an 'oops' facility is provided by CTRL-F10 which restores the most recently deleted word, line or block under most circumstances.

The shifted function keys are concerned with search and replace operations. Paperback Writer only lets you search and/or replace moving forwards through the document, although you have a choice between one-off opera-

'If you don't want to do automatic mailshots, there seems to be little reason to buy a more expensive word processor . . .'

tions and global operations which can, if desired, ask for confirmation of each text replacement.

A useful and unusual feature is the ability to search for or replace special control codes as well as ordinary text. For example, if you want to remove all the hard carriage returns (those entered by the user at the ends of paragraphs) or forced page breaks, you can do so as easily as if you were searching for any other string of characters.

The final batch of function key commands are those signalled by ALT plus the function keys. These are commands which affect the whole file — a global reformat to new margins, saving a file, updating the disk record of a file while keeping it as the edit document (equivalent to *KS in Word-

Star), abandoning a file or looking at the directory.

Cursor movement around a document is very easy and quick, with a wide selection of possible commands. Anyone who learnt word processing with WordStar on an old CP/M machine with no cursor keys will be delighted to find that the same cursor movement sequences apply. CTRL-S moves the cursor back one character, CTRL-D moves it forward, and so on.

Most users will prefer to use the PC's cursor pad. CTRL with a cursor key moves the cursor a word at a time. Using the special keys in the cursor pad, HOME, END, PGUP and PGDN, you can move up and down the document in large or small increments as you wish. DEL deletes from the cursor forwards, and BACKSPACE deletes backwards. It is all very flexible and will be instantly familiar to the hordes of WordStar users, but manages to be easier to use.

One small niggle is that text entry normally has to be carried out in overwrite mode, rather than the insert mode preferred by many users. This is because wordwrap is disabled when text is being inserted.

The slender manual is very clear, with a comprehensive index and contents page making it easy to find any required information. The program's help facility and logical use of the keyboard makes it largely self-documenting anyway.

Conclusion

If you don't want to do automatic mailshots, there seems to be little reason to buy a more expensive word processor than Paperback Writer. If you want something more powerful, your needs might be fulfilled by a more sophisticated package due from the same publishers. Executive Writer, the deluxe version, will cost £59.25, but I had no further information at the time of writing.

END





Of mice and graphics

The mouse is often seen as another superfluous peripheral, but Stephen Applebaum looks at a range of mouse-driven graphics programs that look set to nibble away at this concept.

Since the early days of micro mice, the beasts have gnawed their way through the market, making their mark on machines like Apple's Macintosh before coming to rest on some of the smaller micros, such as the BBC and Commodore 64. Not surprisingly, some of the first mouse-related software written for these machines was graphics-orientated, often bearing

more than a passing resemblance to Apple's MacPaint.

The prime example of a mouse-based graphics package for a cheaper machine is Advanced Memory Systems' AMX Art package, at £89.95 for the BBC. This has been around for some time but has recently been enhanced by the introduction of two disk packages, AMX Utilities (£14.95) and AMX Desk

(£24.95), for use with the mouse.

AMX Utilities is an extension to AMX Art, the MacPaint-like graphics package bundled with the AMS mouse. Although this set of tools extends the range of available functions, it does little to patch up the shortcomings of the mouse hardware (that is, the steel ball-bearing it uses as a tracking device). Unless the mouse is used on a matt surface the cursor often stops, and can only be recovered by vigorously spinning the ball-bearing.

Hardware aside, the AMX system is very neat, but you do need the original AMX ROM package before either suite will operate with your system.

The most appealing aspect of the AMX software is the freedom it offers first-time users. In this respect it is very close to the Macintosh operating system and GEM, and although not as versatile, it does introduce that air of user-friendliness made possible by a mouse and icons. For example, after loading AMX Utilities, the directory is displayed onscreen as a set of easily identifiable characters representing the various options available. Any of these programs can be loaded by simply moving the cursor over an icon and pressing a button on the mouse.

The utility that users will probably find themselves returning to most is AMX Art 2, which is virtually a debugged version of the original art program plus a few extra functions.

Macintosh owners who use AMX Art 2 are often impressed (and a little niggled) by its similarity to MacPaint. The screen display, although not identical, features the same white area reserved for pictures, bordered by the familiar icons which represent such things as an aerosol can, a rubber and a



Top to bottom: the AMX mouse, the Megamouse and the Magic Mouse

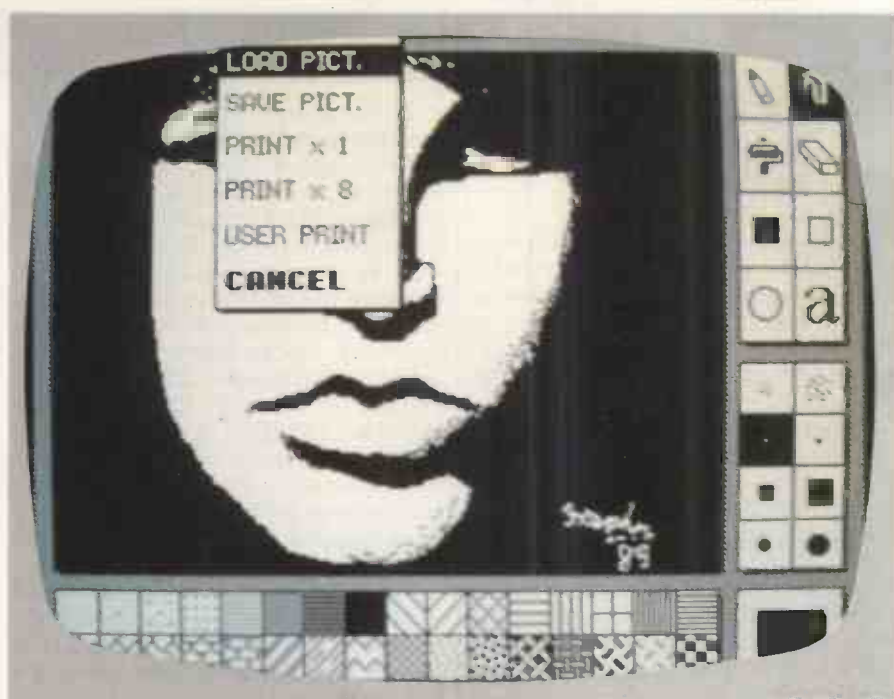

The Door's Jim Morrison, one of AMX Art's 'countless possibilities'

paint brush. A series of boxes runs along the bottom of the screen, each containing one of 32 fill patterns, and this is where the difference between the old AMX Art program and the new one is apparent.

Unlike the original program which was limited to 32 fill patterns, the new one, using a LOAD FILLS function, utilises three times that number. Furthermore, you can create an unlimited number of new shadings with a pattern designer which is included on the same disk.

If you already have pictures saved from previous attempts with AMX Art, they can be loaded into AMX Art 2 with a command embedded in one of the latter's pull-down menus. This gives increased flexibility, as well as a chance to try out your new patterns on some old drawings.

Although there are countless possibilities in the number of patterns that can be produced, the BBC's limited memory confines them to black and white. AMS has provided a small, colour drawing package on the disk which is aimed at children, but nothing that will suit the serious designer.

Complementing AMX Art 2 are a host of smaller although no less useful routines, most of which were conspicuous by their absence from its predecessor. One of the most obvious oversights being the exclusion of a ZOOM command, this and other handy routines have now been included, many of which can be found in the Goodies menu of a program called Utils.

Also resident in the Goodies menu is COPY, a powerful command which makes use of an extensive set of special effects. Apart from being able to copy over, invert or wipe a picture, part or all of it can be duplicated and rotated

through a number of different angles at almost any position onscreen. Two further routines allow ellipses and arcs to be drawn quickly and quite accurately, without the user having to do anything other than plot a few points.

If animation is your forté, a Slide utility lets you string together up to 25 AMX pictures and then view them consecutively, producing the illusion of movement in much the same way as a child's flick book. Scrolling between frames can be either manual or automatic. A time interval must be entered for the latter method but, as the manual warns, short intervals between slides can cause severe wear on the disk if used for long periods. As a counter-

measure, AMS suggests that the minimum interval between frames should be 15 seconds, a period of time which will prevent damage to your disk but still produce some jerky animation.

AMX Art 2 contains a printer driver which allows any picture to be reproduced on hard copy, in formats of one or eight times the original size. In addition, a utility called XdGen gives users with screendump ROMs the option to create a program to dump pictures to non-Epson standard printers.

As much of the AMX mouse operating software is held in ROM, it is possible to incorporate the device into user programs. New commands can be accessed using the '*' prefix, two of which, *MOUSE ON and *Mcursor ON, switch on the mouse and use it for cursor key functions respectively. Owners of Wordwise, Wordwise-Plus and View will be able to utilise the mouse instead of the BBC's four arrow keys. Another * command allows each of the mouse's three buttons to be programmed for a specific function (for example, set marker or move block), replacing the chore of having to fumble for a red function key with a single flick of the finger.

As Advanced Memory Systems' other program, AMX Desk, moves away from art programs into the world of desk-top environments, I won't go into it in detail here, but it does have interesting electronic equivalents of those little necessities like a memo pad, a diary, a telephone/address book and even a pull-down calculator.

If you are put off AMS software because of its lack of colour, you'll be pleased to know that Watford Electronics has produced colouring software designed to work with the AMX package. It's called Colour Art, it comes on disk and costs £14.95. And another



Add colour to your artistry with Wigmore Houses's Cadmouse



company, Wigmore House, has produced a mouse (or trackball) controlled package called Cadmouse, which offers many of the same functions as AMX Art 2 (as well as a few useful extras), plus the luxury of colour.

Wigmore House's mouse, immodestly named Megamouse, works on virtually any surface thanks to the use of a rubber rather than steel ball. It grips better and is quieter, a point which has led to it being dubbed the 'whispering mouse'. This rather chic and accurate (100 points per inch) mouse must be one of the few all-British peripherals to have earned the distinction of being used on several Japanese computers, including Epson's new QX-16 (Benchmarked PCW, July).

Certain inevitable similarities crop up between Cadmouse and the graphics package looked at previously. However, ultimately they are each aimed at different markets; the AMX system being orientated toward the popular and, to a lesser extent, small business fields, while the Megamouse seems to be scuttling in behind the Bitstik as a low-cost piece of 'serious' design software — or so claims Wigmore House.

Cadmouse is well equipped for simple design work as it can operate in the BBC's high-resolution (640x256) mode 1. The number of colours in this mode is limited to two, but that is unlikely to worry the type of user the package is aimed at. Draughtsmen could find Cadmouse useful for making rough plans with as it features not only all the usual things such as rubber lines, circles, ellipses, arcs, polygons, and so on, but also technical symbols like centre lines, hatched fills and even dimension lines which can be drawn at angles of 0, 45 or 90 degrees. Text can also be added at the same three angles, allowing drawings to be fully annotated.

There are two types of fill-in Cadmouse — hatched and solid. Both these are quite simple fills, having been written in a way that forsakes accuracy for speed. The result is that, when trying to colour large areas, gaps are left and have to be filled separately, negating the original idea of saving time.

Cadmouse also operates in the low-resolution mode 2, but where resolution is lost, memory is freed, enabling four instead of two colours to appear simultaneously. This mode is perfect for general drawing, and users should find that the different functions available suit most of their needs.

Of all Cadmouse's tools, I found DRAG, DUPLICATE and INVERT to be the most powerful for manipulating parts of my drawings during both creation and editing. As it implies, DRAG allows specific areas of the screen to be windowed and then literally moved to another position. Its sister command, DUPLICATE, does

much the same, except this time it is an image of the window's contents that is moved, leaving the original in place. The third function, INVERT, works like DUPLICATE in that it produces a copy, the difference being that it is a mirror image of the original.

Cadmouse is an impressive package, but there are several frustrating features which could have been implemented better, or differently. For example, when confirming some commands, instead of double-clicking the mouse's execute button, you have to move the cursor to an icon representing a tick, which can mean moving it from one corner of the screen to another. Being disk-based it is also quite slow, as you have to wait for data to be loaded each time a function is selected.

Users with printers other than an Epson or one of the compatibles have once again been left out in the cold. It is possible to integrate your own printer driver, but that could mean having to write it yourself.

None of these points is anything more than annoying, and I would recommend Cadmouse (£103.73 including mouse) to anyone who enjoys dabbling with graphic design on a computer. For those who are rather less ambitious, there's a cut-down art package called Mousepaint. This is more suitable for children and can be bought on its own with the mouse for £86.94 on tape or disk, or together with Cadmouse for £114.54. Further software, possibly including ROM-based applications, is planned, but as to what it could be, Wigmore House's door is staying shut.

Whereas the BBC Micro is becoming infested with mice, the little beasties seem to be thin on the ground where the Commodore 64 is concerned. A few are available, and I had hoped that they would provide another useful alternative for Commodore 64 owners. But the first I've seen, SMC's Magic Mouse, failed to live up to my expectations, as neither the software nor the hardware is really up to scratch.

Compared with the BBC packages, the Magic Mouse is cheap at £59.95 (including tape and disk versions), but you get what you pay for. Several things are wrong with SMC's mouse, the most obvious disadvantage being its size. Unlike the Megamouse which fits snugly under the palm of the hand, the large, heavy, rat-like Magic Mouse feels bulky and uncomfortable. Its weight can be attributed to a rubber-coated ball-bearing which sits in a recess toward the back of the mouse's base. This odd positioning of the ball-bearing makes the Magic Mouse more difficult to control than Wigmore House's,

although at least it does not have to be wrestled with like the AMX Mouse.

With regard to the software, the Hi-Res Graphic Designer is similar to the Koala graphics pad. Most of the program is menu-driven and, although it works using icons, you have to toggle between the main menu and drawing screen to select an option. Most of the functions offered within the program are of the basic Draw, Spray and Circle variety, but these are ruined by either the low (160x200) resolution or the inaccurate mouse. Fine work is not really possible with the mouse, so various keys on the 64's keyboard have been implemented to move the cursor a single pixel in one of eight directions.

If you manage to design anything worth saving, the Hi-Res Graphic Designer allows pictures to be saved to disk or tape, or dumped to a printer. There are two printer drivers within the program, one of which dumps a screen to a Commodore printer while the other works with a Centronics device.

Both the sprite and icon designer programs are very similar, each allowing characters to be drawn and used within user programs. In both cases, the sprite or icon is designed on a grid 24 x 21 characters in size. This can be saved, and then called back into a program using several special pokes.

The last program, the mouse controller, gives the user access to the interrupt-driven mouse control routines. In other words, it allows you to utilise the monster in your own programs, once again using the odd POKE.

Conclusion

The combination of a mouse and icons would appear to be a step toward making computers easier to operate, especially for those who dread the idea of having to tackle a keyboard. However, unless enough thought is put into the design of both the hardware and software, the result can be that the mouse is little more than just another peripheral hanging off your micro. Neither the AMX Mouse nor Megamouse fall into the category of superfluous equipment, although the usefulness of the Magic Mouse is debatable.

Of all the packages I looked at, Wigmore House's Megamouse manages to retain the best balance between the quality of the software and mouse hardware, but I still prefer the AMX software because of the cheeky way in which it reproduces many of the effects normally attributed to machines with bit-mapped screens.

For further details about the products reviewed, phone:

Advanced Memory Systems — (0925) 602690

Wigmore House — (01) 734 8826

SMC Supplies — (01) 441 1282

Watford Electronics — (0923) 37774 **END**

MEGA-BOARD™ XT

#1 CHOICE OF MAJOR OEM MANUFACTURERS, UNIVERSITIES, RESEARCH LABS ETC. A THOROUGHLY FIELD PROVEN DESIGN. HIGH VOLUME PRODUCTION ENGINEERED.

- FULL IBM PC-XT* COMPATIBILITY!
- FULL MEGA-BYTE RAM CAPACITY ON MOTHERBOARD!

THOUSANDS SOLD WORLD WIDE!

DEALERS AND OEM MANUFACTURERS QUANTITY DISCOUNTS AVAILABLE

Standard Key-board Interface (Full PC compatible)

Hardware Reset (Overcomes reset flaw in PC)

Eight Compatible I/O Interface Connectors
(Full PC compatible) (compatible with all IBM-PC* plug-in cards)

Power Connector
(Full IBM* pinout compatible)

Special J1 Interface
(Allows horizontal mounting of compatible expansion cards for easy bus expansion and custom configuring) (Board has 62 pin gold plated compatible connector)

8088 Processor
(Same as PC)

8087 Numeric Processor
(Same as PC)

Extended ROM Capability
(Runs all compatible PC ROMS) (Jumper programmable to accommodate all popular 8K, 16K, 32K and 64K ROM chips and NEW EE ROMS! VPP power pin available for EP ROM burning!) (External VPP voltage required)

Peripheral Support Circuits
(Same as PC)

Configuration Switches
(Same as PC)

Speaker/Audio Port
(Same as PC)

Wire Wrap Area
To facilitate special custom applications!

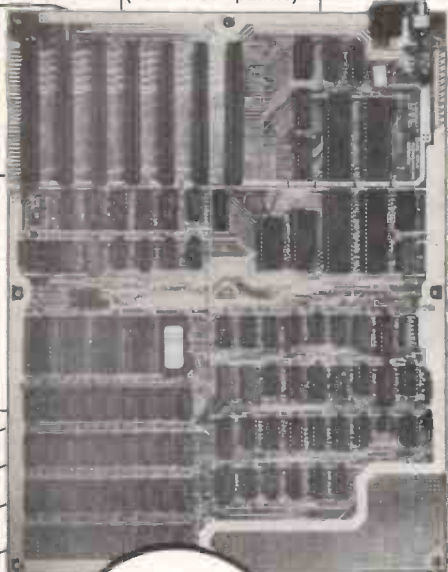

ONLY! £85.00 + VAT

Mega-Board™ Evaluation Board Kit!
(Blank board with full assembly instructions and parts list.)

Includes highest quality PC board with gold plating, silk screen, solder mask

Board Size 10.5 inch X 13.5 inch

Full Mega-Byte Ram Capacity! On board!
(With parity)
 256K Bytes using 64K chips
 1 Mega Bytes using 256K chips

SOUTH DEVON MICROCENTRE LTD
THE OLD POSTERN
DARTINGTON
TOTNES
DEVON TQ9 6EA
UNITED KINGDOM

CALL **ROGER BUTLER**
(8030) 866076
FOR DETAILS

PRICE LIST

	£
Bare Board Kit	£79.00
Assembled Tested Socketed	£158.00
Fully Assembled and Tested	£412.00
Evaluation Board Kit	£95.00
Manual	£15.70
Mega-Bios Rom	£24.00
Case	£82.00
Keyboard	£123.00
Monochrome Card	
Graphics Card	
Disk Controller	
Disk Drives	
Hard Disk Controller	
Power Supply	
	Call for prices
	£124.00

DTC™ DISPLAY TELECOMMUNICATIONS CORPORATION

4100 SPRING VALLEY ROAD
SUITE 400
DALLAS, TX 75234
(214) 991-1644

TERMS: We accept cash, checks, money orders, or purchase orders from qualified firms and institutions. Prices are subject to change without notice. Shipping and handling charges via UPS ground add UPS at \$1.00/lb. Minimum charge \$3.00.

*IBM and IBM PC are trademarks of International Business Machines

©1984 Display Telecommunications Corporation

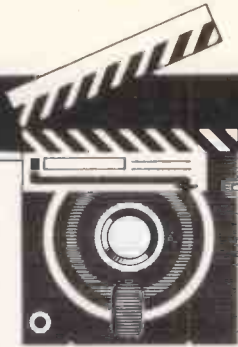

SCREENTEST

Jazz

Lotus' long-awaited Jazz integrated package is an attempt to launch the Macintosh into executives' favour. Peter Bright tests the competence of this word processor/database/spreadsheet/comms software.

I can't think of a single piece of micro software that has been waited for longer or had more expected of it than Lotus' new Jazz integrated software package for the Macintosh.

Apple hopes it is the product to get the Macintosh on the executives' desks, something that Apple has always lusted after, and the press has been waiting for a heavyweight name other than Microsoft to throw itself behind the Mac.

Now it's here.

Packaging

Whenever an expensive piece of software arrives in the office, I always worry about how much of the punters' hard-earned cash is being spent on flashy packaging that gets thrown in a cupboard and is never seen again.

This is especially true of Jazz, where

you have to peel off three layers of cardboard, plastic and rubber before you can get at the program disks. The first layer is a very flashy-looking red and black cardboard box with the Jazz logo plastered all over it. Take off the cardboard lid and you are faced with a black-ribbed rubber folder with a red stripe down the side which holds the manuals. I thought this looked quite trashy, but the art-conscious types in the office told me that black rubber ribbing is terribly trendy. C'est la vie.

Other little knick-knacks in the box include a small black plastic wallet to hold your Jazz disks, for which I could find no good use, and four snazzy Jazz disk labels.

Included in the box are no less than six manuals: a primer, a handbook, a quick reference guide, an update sheet, and leaflets on how to start up the

system and convert data from other packages. The standard of production for the manuals is the highest I have ever seen, with very high-quality paper, glossy covers and liberal use of colour photographs. It must cost a fortune to produce. The quality of the text was generally good too, with plenty of screenshots to illustrate different points. But good as the manuals are, I can't help wondering if they are rather over the top for a Macintosh application. I only needed a manual on very rare occasions, usually just to confirm that what I was doing was right.

The program

The minimum system configuration needed to run Jazz is a 512k Mac with twin disk drives. Four disks are included in the Jazz box, marked 'Start-up', 'Program' and 'Back-up Disk'. A tutorial disk was also supplied.

To get Jazz running, you need to put the start-up disk in one drive and the program disk in the other. Lotus tells you to put the start-up disk in the internal and the program in the external, but in practice it doesn't matter which way you do it.

The start-up disk contains all the usual Macintosh system files and a couple of Jazz utility files. There is nothing to stop you making your own start-up disk — any Mac disk containing the system files will do. The only point to remember is that Lotus has customised the standard Mac 'system' file, so if you use the system from another disk, you will need to run the Jazz System Update utility which is supplied on the start-up disk.

The program disk is the one that actually holds the Jazz program files. This disk is copy-protected, but Lotus does provided a back-up should you mangle the original.

Starting Jazz is done in the traditional manner by double-clicking the Jazz

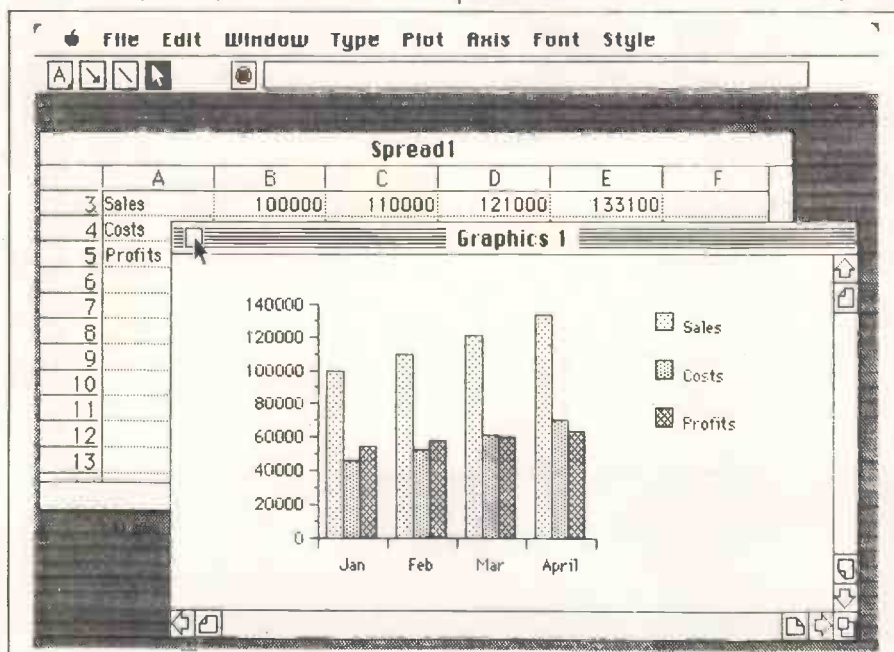

Fig 1 A graphics window with a spreadsheet window underneath

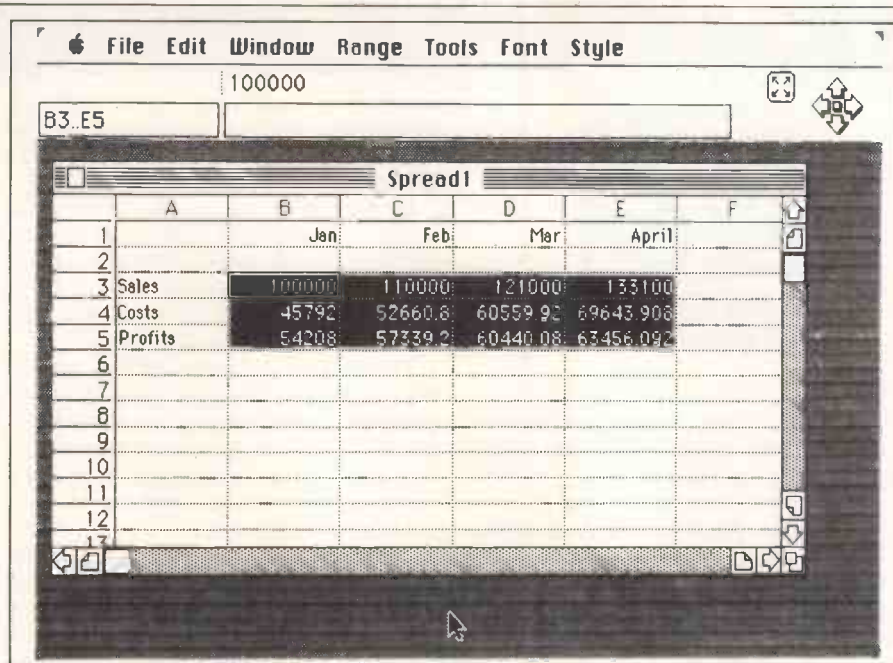

Fig 2 A worksheet window

icon on the Finder desk-top. When you have done this, you sit back and wait for the program to load. Eventually a blank desk-top is displayed, complete with 'File' and 'Window' pull-down menus. The two main options in the File pull-down menu are 'New' and 'Open'; New creates a new file, and Open allows you to load a previously saved file.

Windows

Assuming you want to create a new file, you select New. This then displays a window containing different icons for the different types of document you can create; worksheet, graphics, database, form, word processing or communications. To open a new document, you simply double-click the icon for the type of document you want. The system will then open a window on the screen containing a blank spreadsheet, word processor document or whatever, and you can start typing.

When a new window is opened by the system, it only takes up about half the screen. You can play around with the size and position of the window in normal Mac fashion, or you can zoom it up to full-screen size by using the 'Zoom Up' option from the Window pull-down menu.

One of the main features of Jazz is that it is possible to have many different documents open onscreen at the same time. Each document has its own window on the screen, which means that you could have, say, a word processor document, a spreadsheet and a graphics window all open and onscreen simultaneously. You can switch between the documents by simply selecting the appropriate window with the mouse.

There are two main limitations on the use of multiple windows. Firstly, the number of documents you have open on the screen depends on the amount of free memory in the Mac. With no

documents open, the Mac has about 256k of RAM free. Each document you have open obviously takes up some RAM. If you only have small spreadsheet models, databases or word processing documents, you can obviously have more windows open than if you have large documents.

One drawback of Jazz is that it isn't virtual and is therefore totally RAM-bound; the other limitation is that Jazz isn't concurrent. This means that although you can have multiple documents open at the same time, the Mac is only processing the foreground document you are working on: the others are inertly sitting in RAM waiting to be worked on. This means that it isn't possible, for example, to print one word processor document while working on another, which is rather disappointing.

The best way to describe how Jazz

works is to run through each of the different document types, and describe how they work and how they link to each other.

Worksheet

As you would expect from Lotus, the Jazz spreadsheet is quite comprehensive. Jazz includes a utility which will convert Lotus 1-2-3, Symphony and Multiplan SLYK files into the Jazz format. You can transfer the files from your IBM PC, either by using the built-in Jazz comms or by using a package such as PC to Mac and Back.

Nominally, the Jazz spreadsheet extends to 8192 rows by 256 columns, but as with Lotus 1-2-3 there is no way you can use all these cells. Even if you take a totally empty worksheet and try to enter one number into the last cell, you will get an 'out of memory' error from the system. The actual maximum, with no other windows open, is around 61,000 cells which can be arranged as a 240 x 256 grid.

When a worksheet is open, the screen can be divided into three separate areas: the top line is taken up by the standard Mac-style pull-down menu bar; the next two lines are taken up by the 'console' which contains control icons and editing boxes; and the rest of the screen is the normal Mac desk-top containing the document windows.

I must say that the Jazz spreadsheet is the easiest-to-use spreadsheet I have ever come across. You can use the mouse to do virtually anything bar enter the figures, and there are no less than three different methods of getting around the sheet. In addition to the usual scroll bars, there is an 'end navigator' which moves to the corners of entered data blocks, and a 'corner navigator' which allows you to move around a selected range.

Setting up a spreadsheet is very easy. If you don't like a column width, you just

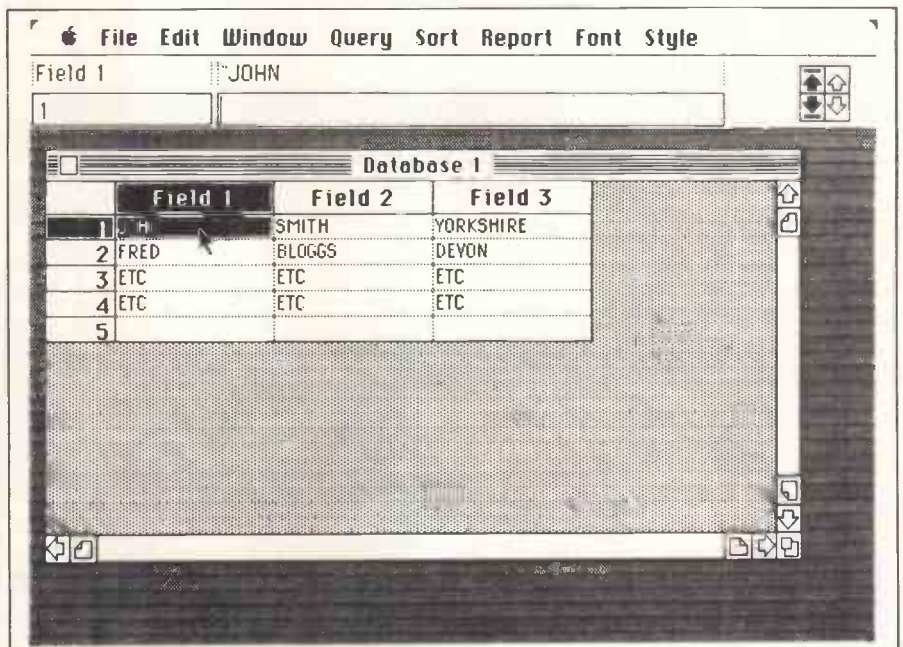

Fig 3 A database window



SCREENTEST

drag the column separation line around with the mouse until it is the right width. You can select a range of cells simply by dragging the cell selector box over the cells while holding down the button. Copying and moving blocks of cells is simplicity itself — just use the standard Mac 'Cut', 'Copy' and 'Paste' options from the 'Edit' menu. Replicating cell values and formulas is done in the same way, and is just as easy.

The great thing about the spreadsheet is that it has all the usual spreadsheet-type power, mathematical functions and 'What if?' type ability, but the Macintosh environment makes all this functionality much more accessible and easy to use.

The one disappointment I had with the spreadsheet is that although you can have multiple spreadsheets open at the same time, there is no way that the cell references can cross-reference each other from sheet to sheet. This means that the type of consolidation allowed by packages such as Ashton Tate's Framework isn't possible under Jazz, which is surprising given the integration facilities that are provided on the word processor.

Graphics

Unlike products such as Lotus 1-2-3 in which the graphics are part of the spreadsheet, Jazz graphics is treated as an independent document and given its own window.

Let's pretend that you want to make a graph of some of your spreadsheet data. Firstly, you need to open your spreadsheet document and then open a new graphics document in order that both windows are displayed onscreen. To make a graph, you highlight a range on the spreadsheet, switch to the graphics window, and select the type of

graph you want from the 'Plot' pull-down menu. If you want to plot another range on the same graph, simply repeat the process and both ranges will be plotted. It really is very simple.

Jazz allows you to plot a much wider range of graph types than are usually available. In addition to the normal pie, line and bar charts, you can also plot area charts, scatter graphs and stock market style graphs.

When you've finished the basic graphing, you can make it look more interesting by entering legends and titles, and annotating any of the entries. All the usual Macintosh fonts and text sizes are available, so you can make your graph look quite pretty.

Word processor

The word processor contains some of the nicest and some of the nastiest features of Jazz. My first impression was that it looked very similar to MacWrite. The top line is the standard Mac pull-down menu, the second line contains icons very similar to MacWrite which allow you to set the line spacing, justification, and so on, and the rest of the document is a standard Macintosh window.

The top line of the word processor window contains a one-line ruler that looks very like MacWrite. You can use this to set margins, tabs and paragraph

indents in exactly the same way as MacWrite; you can also paste in new rulers as you go along to alter the layout of the text in a specific way.

By far the nicest feature of the Jazz word processor is the 'Hotview' option on the pull-down menu. This allows you to include information from other documents in a letter or report that you are writing on the word processor.

The standard way to do this on the Macintosh is to use the clipboard, and to cut and paste information from other applications into the word processor. As Jazz was designed as an integrated product, there is no need to use the clipboard in this case.

Suppose that we want to include some spreadsheet data, and a graph on that data. Firstly, you have to make sure that all the documents you are going to call are open on the screen. You write your report until you get to the place where you want to insert the spreadsheet data, and you select the spreadsheet window and highlight the range you want to copy. Then you simply go back to the word processor document and select 'Include' from the Hotview pull-down menu, and an image of the spreadsheet appears in your text.

The same thing happens with the graph: you type some more text, select the graph and then include it in the document. The great thing about the graphs is that they can be scaled, so you can play around with the size in the word processor document.

All this is fairly standard Macintosh. The neat part is that if at a later date you change the data in the spreadsheet, that change is automatically reflected in the word processor document. This is true even if you don't have the word processor document open when you make the change to the spreadsheet. The only time this can't be done is if the word processor document and the spreadsheet document are on different disks, in which case the system tells you that it can't update the data in the word processor.

Hotview also has a mailmerge-type facility which allows you to insert data from the spreadsheet or the database into merge-printed word processor documents.

Now for the not-so-neat features of the Jazz word processor.

Firstly, it crashes. Admittedly you have to get devious, but it definitely crashes. I was experimenting with the word processor one afternoon, and I kept my finger on the '.' button so that it auto-repeated to fill about three-quarters of the screen width. The first thing I found was that it wasn't possible to place the editing cursor anywhere in the middle of the line of dots, although it worked normally in the test of the text onscreen. Secondly, I put the cursor at the start of the line of dots and hit the space bar a few times. The system

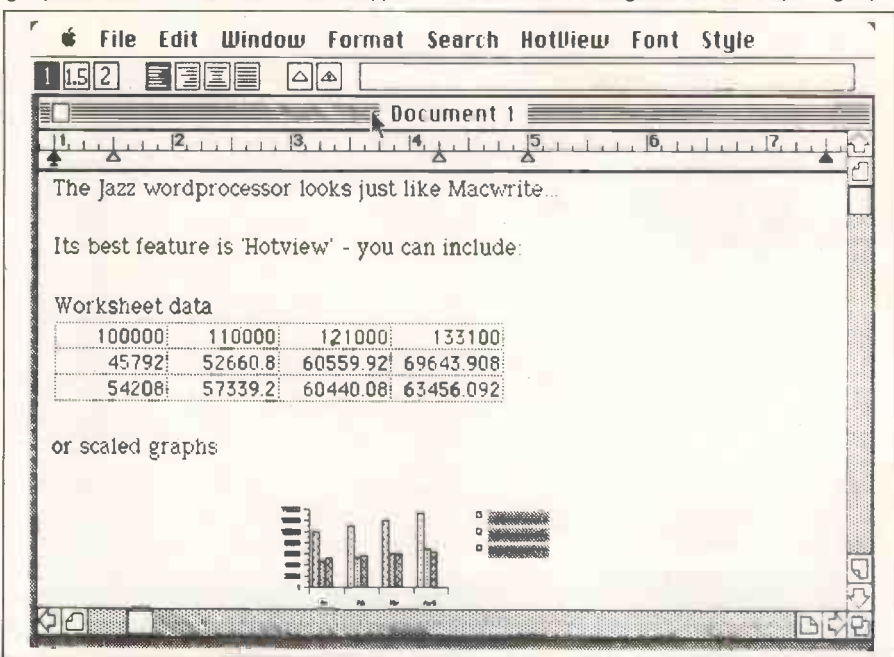

Fig 4 A word processor window

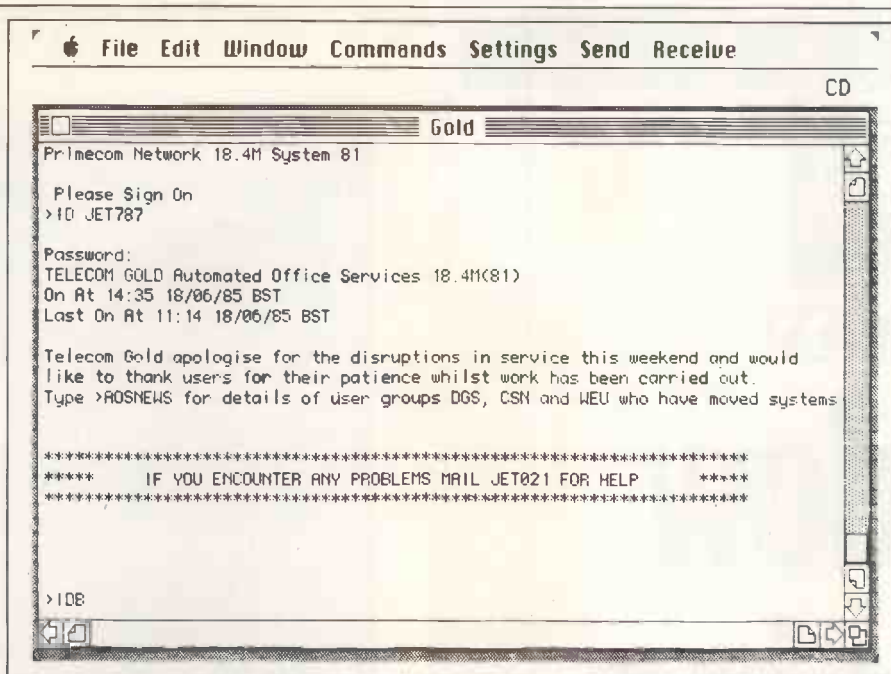

Fig 5 A communications document

completely crashed out, messed up the screen and started beeping plaintively. The only thing to do was to reset.

This happened each time I repeated the process. When I phoned Lotus UK, the same thing happened on the company's machine and it said it would look into it. As far as I know, it is still looking into it. Although I must admit that the circumstances leading to the crash are slightly unusual, you must be worried by any system that crashes out completely without being caught.

Other assorted niggles include no page numbering, so you can't tell which page you're on. The editing procedure is inefficient: the system sometimes re-draws the entire screen when you make a small change. This generally leads to a very slow response time, which can get extremely bad if you are working at the end of a long document.

Finally, text seems to be stored internally in a very strange way. Although you begin with about 256k of RAM free, it runs out after 20-25 pages of single-spaced text. This could be a limitation if you write long documents.

Database

Kathy Lang will be looking at the Jazz database in more detail soon, so I'll just feature some of the highlights here.

Assuming that you are creating a new database, the first thing you have to do is to enter names and details for all the fields in the record. The field data you have to specify includes the display width, but Jazz can store up to 254 characters per field, regardless of the display width setting.

When you have finished setting up the fields for the database, Jazz displays a spreadsheet-type screen with the field names running along the top and records running down the side.

You can now enter data directly into the database simply by entering it into the spreadsheet-style cells. Although

this works, it's rather strange entering data into what looks like a spreadsheet. If you don't like this, you can create a more traditional data entry form which sits on top of the sheet and enters data into the database.

To do this, you need to open up a form-type document. When this opens, Jazz automatically looks at the open database and transfers the field names to the data entry form, with data entry boxes next to them so that you can enter data. You can either take the form that Jazz creates for you, or customise it in some way. Data is entered by TABbing between fields plus the 'Add Record' option from the Edit pull-down menu, or by hitting COMMAND N from the keyboard.

When you have entered your data onto the 'spreadsheet', you can play around with fields and records in much the same way as a normal spreadsheet by highlighting them using the mouse, and so on. You can also set up calculated fields and formulas.

In addition to the spreadsheet-type operations, you can sort the records in the database and apply specific search criteria to the data. Reports can be set up in much the same way as a spreadsheet.

Communications

The final feature of Jazz is its communications abilities. Like the other features, communications is document-based so you just open it into a window.

The communications window can be set up to either emulate a DEC VT52 or VT100 terminal. VT52 will do for most dial-up services, with VT100 being very handy for accessing more specialised services.

Jazz communications can drive either auto-dial/auto-answer or regular modems. As supplied, it has drivers for Hayes or Apple auto-dial modems and

provides full control over the auto-dial functions. I didn't have access to either a Hayes or an Apple modem during the test, so I tried it with a Miracle Technology WS2000 modem and dialled manually. This worked very well.

Jazz communications allows you to change all the settings you would expect for a comms program — baud rate, word length, parity, and so on. In addition, it has fairly comprehensive file transfer abilities. It can send and receive disk files as text with no protocol, or disk files using the XModem protocols or a special Jazz-to-Jazz protocol.

Besides being able to run incoming data to a disk file, you can send it directly to a word processor, spreadsheet or database document without having to go via a disk file.

Conclusion

Lotus has done a great job of integrating Jazz into the Macintosh environment. Although this is a very complex piece of software, it really is extremely easy to use. I liked the spreadsheet for its ease of use, the graphics for its range of abilities and the comms for its functionality.

I initially liked the word processor, but as time went by its shortcomings started to irritate me. However, the Hotview facility is absolutely great and is a good example of integration at work, and the database is certainly an improvement over Lotus 1-2-3.

I was worried that I consistently crashed the word processor: that kind of thing shouldn't happen on a release version of a product. The second problem comes down to memory management. With only 256k of RAM to play with and each open document taking its chunk, you have to balance the number of open documents against the size of each document. This isn't helped by the use of what seem to be old-fashioned 1-2-3-style memory management techniques.

Having said all that, Jazz is still a very good general-purpose tool; whether you buy it depends on your outlook on the Mac. There are two ways to obtain multi-functionality on a Mac: one is to buy Jazz which does everything well but nothing wonderfully; or you could wait for the soon-to-be-released Switcher RAM partitioning software and build your own pseudo-integrated system.

The advantage of this approach is that you can choose a powerful program to do the frequent tasks and then integrate less powerful programs to handle the less important jobs. The advantage of Jazz are: a) that it has a higher level of integration than you could get with the Switcher; and b) Jazz is available now, the Switcher isn't.

If you think you need an integrated package, Jazz is the one for you. But if you don't need *all* the features, you might be better off building a DIY system. **END**



SCREENTEST

Window shopping

The best-dressed business micro is currently sporting an add-on windowing facility for increased user friendliness.

Nick Walker tried the three main contenders in this field — Digital Research's GEM, Microsoft's Windows and IBM's Top View — on an IBM PC to find the perfect fit.

In many ways, the micro industry is akin to the fashion industry. Neither business is able to predict with any certainty what the consumer will buy this year or next year.

In the software industry, this has led to a series of software 'fads'. We've had the year of fancy business graphics, the year of the monolithic integrated package, and now we seem to be facing the year of the 'window'.

To be fair, the 'friendly' user interface movement has been around for longer than most people realise. Much of the development behind the concepts of windows and mouse-driven friendly interfaces was done at Rank Xerox in the US. Xerox, with its customary inability to recognise a good thing when it saw it, incorporated the ideas into a very expensive executive workstation called Star. Then came Apple — first with its unsuccessful Lisa, and then with the considerably more successful Macintosh.

One effect of the Macintosh has been to popularise the concept of mice, icons, windows, and so on, to the point where independent software manufacturers have now developed bolt-on packages to make other micros more friendly.

There are now three main players in the bolt-on friendliness stakes — Digital Research with GEM, Microsoft with

Windows and IBM with TopView. GEM and Windows are attempts to establish a new graphics standard for writing applications packages — one which could apply to all micros running them. GEM is the closest to Macintosh standard, while Windows isn't quite as friendly but does add functions such as concurrency. TopView really stands apart from the others in that it is purely designed for the IBM PC family and its clones, and can best be described as an application integrator with the added advantage of multi-tasking.

It is important to realise that none of these products is a replacement for an operating system. They all sit on top of the host computer's operating system and try to provide a friendly, easy-to-use environment from which applications can be run and housekeeping functions can be performed.

While micro hardware has advanced considerably over the past 10 years, operating systems have lagged behind for the good reason of maintaining application software compatibility. For programmers of new applications this has been a severe restriction, forcing them to ignore the legal OS calls and program directly into the hardware, making the application once again machine specific. Windows and GEM are attempts to set a new graphics standard that sits above any operating

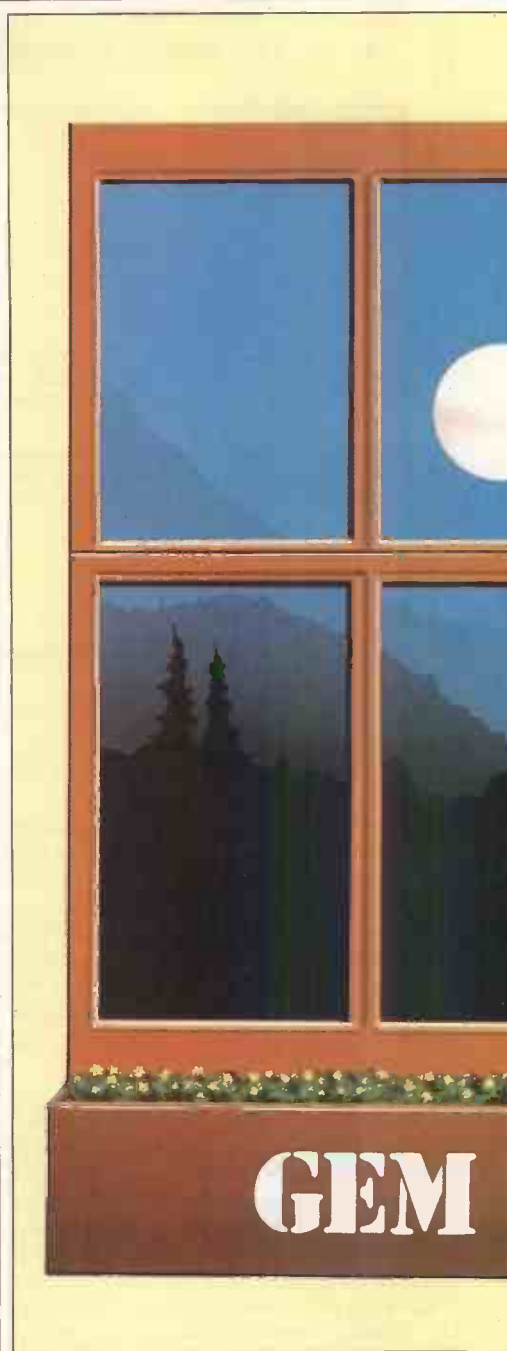

system and gives the necessary power for writing advanced applications. These applications can then be easily transported from one machine to another, usually only requiring minor editing of the source code, a re-compilation, and inclusion of system files. GEM has already shown its ability to do this with some of its early applications appearing on Acorn, Atari and Apricot machines. Windows has been written with the same ability, and Microsoft has the advantage of the wide user base for its own 16-bit operating system, MS-DOS.

GEM has its roots in an earlier graphics interface called GSX, which was taken up by a number of manufacturers. To this they have added the pixel graphics operations that enable smooth movement of mouse pointers, icons and routines for easy window management, pull-down menus, and so on. Similarly, Windows has a graphics interface lurking in its depths,

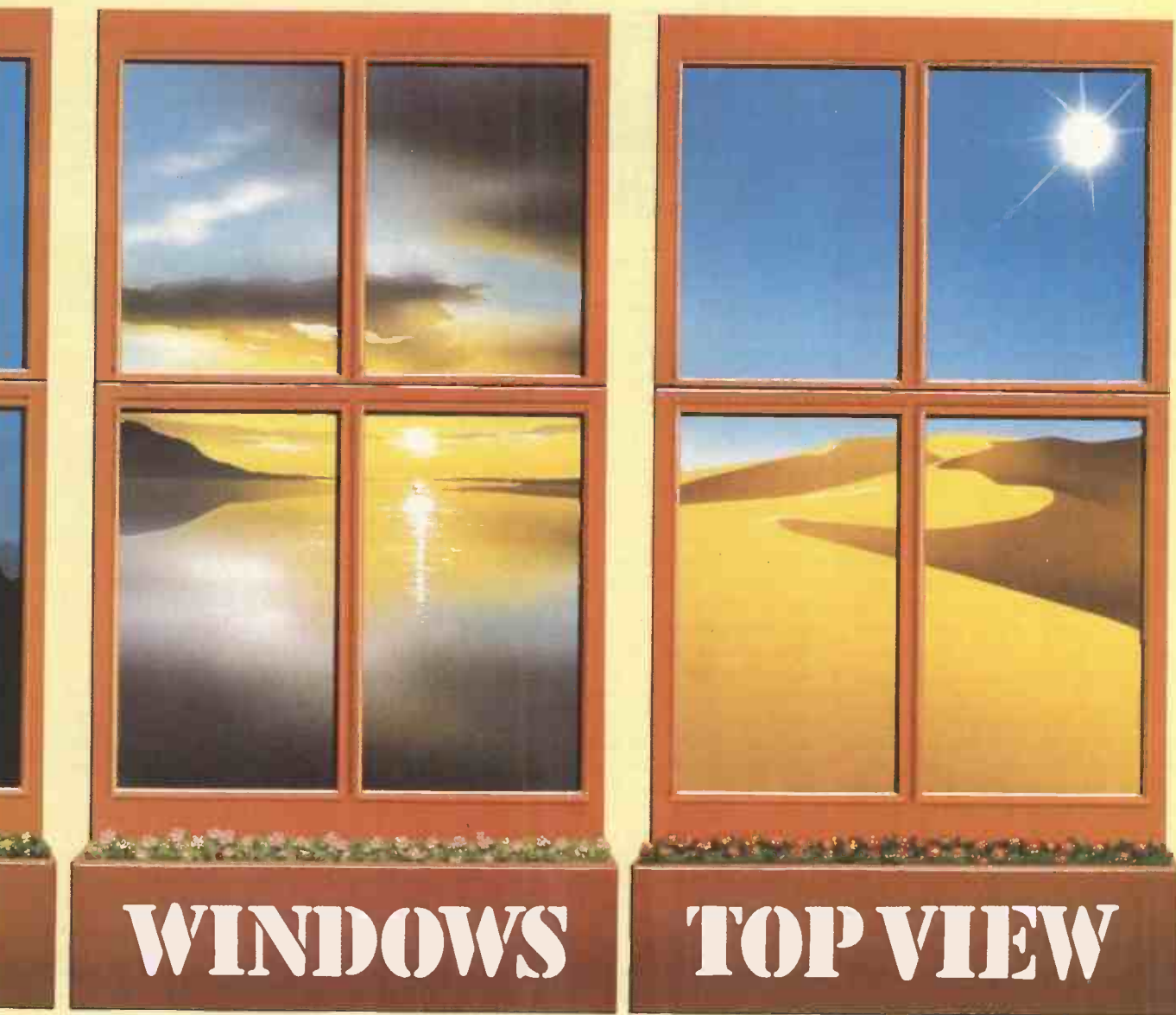

the GDI (Graphics Device Interface), but this has never been commercially available by itself.

TopView sits outside this part of the battle, being designed to operate with standard (and preferably well-behaved) PC-DOS applications.

The desk-tops

No matter how much power these packages give you and how well-written they are, it's a very small part of them — it's desk-top or user interface that is the most important. A good desk-top should be easy to use and yet unleash the full potential of the system underneath. In particular, it should shield you from the complexities of DOS, making actions such as copying and deleting files, starting applications and printing files easy and intuitive. In the case of GEM and Windows, the desk-top is itself an application running on the underlying system; it just happens to be the one that runs first and

the one that's needed to operate the system. This approach has the advantage that, if a desk-top is universally disliked or a new wonder-feature is required, it is possible to re-write the desk-top as required. With TopView, the user interface is an integral part of the whole package.

The GEM desk-top is the most Mac-like of the three systems — anyone who has the Macintosh will immediately feel at home here. Along the top of the screen is a menu bar, down the left-hand side are icons for floppy disks and hard disks (if you have them), and below these is the ubiquitous 'trash-can'. The mouse's primary function is to control an arrow-shaped cursor, which is used to point to a relevant part of the screen. A full description of the GEM desk-top appeared in the February issue of *PCW*, so I'll just cover it briefly here for comparison purposes.

Most of the screen is shaded grey, upon which you can open and manipu-

late windows. A double click on the disk icon or a single click and selection of the appropriate option from the menu bar will result in a window opening, containing a graphic representation of the files on that disk. Documents are shown as a piece of paper with the corner folded down, applications as a box with a solid bar at the top and an appropriate icon within (typewriter for word processors, telephone for comms, and so on), and folders are shown as folders.

The menu bar contains pull-down menus labelled Desk, File, View and Options. As soon as the mouse-driven cursor approaches one of these labels a menu shoots down, listing the options under that heading. Initially this can be annoying — other systems usually require a click of the mouse button, but after a while it's quite usable.

The Desk menu contains two desk accessories, a calculator and a clock. Further accessories and applications can be installed into this menu by the

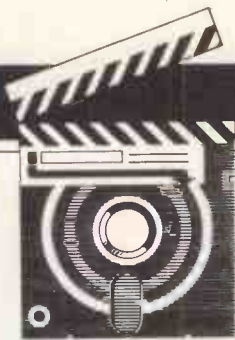

SCREENTEST

user. File allows you to open files and disks, put information on a file, create new folders, format disks and quit GEM. View lets you arrange files by size, date, name and type, and display them in text form if required. Options is where other, sundry functions lie — changing system parameters, installing applications and disk drives, and entering the more obscure DOS commands.

Windows can be overlaid, they can overlap or sit side by side on the desk-top; positioning the cursor at the top of the window, and pressing and holding the mouse button allows you to position the window anywhere within the desk-top. Windows can be shrunk and expanded by the same action on the mouse with the cursor over a small overlay icon in the bottom right-hand corner of a window. One feature of GEM's window management I particularly like is the diamond in the top right-hand corner which enables you to expand any window to full-screen size and then contract it down to its original size. Scroll bars run along the bottom and the right-hand side of a window, allowing you to scroll through lengthy documents.

The majority of housekeeping commands work intuitively on the GEM desk-top. Files are copied by dragging their icons to where they are to be copied; applications are started by a double click on the mouse, and deleted by being dragged to the trashcan. Error messages are displayed as dialogue boxes that appear on top of everything else on the desk-top; all error messages are in English, and most give you the option of re-trying the action that caused the error.

Windows' desk-top is a program called MS-DOS Executive, and once again the influence of the Mac is apparent but a little less so than with GEM. When MS-DOS Executive is running, the screen is mainly white with a grey bar at the bottom, outside the

MS-DOS Executive window. A menu bar runs along the top of the screen with the options File, View and Special, and below this to the right are icons representing the floppy and hard disk drives. The mouse controls an arrow-shaped cursor within this window which can change to other images when outside MS-DOS Executive or when running applications.

Moving the cursor over the disk drive icon and clicking the mouse button will display the files on that disk in text form within the window, with sub-directories shown in bold type. The cursor can then be moved over the entries in this directory, and a file selected by clicking the mouse button. This file would then be highlighted, and a number of options to operate on this file become available in the pull-down menu. Double-clicking on a file will cause an application to be run, a document to be loaded into the application that created it, or a display of the files within a sub-directory. When you run an application, MS-DOS Executive shrinks into an icon that appears at the bottom of the screen. To use the MS-DOS Executive application again, you expand this icon by dragging it back into the desk-top area; the application you started now forms an icon, and MS-DOS is available for use.

To get multiple windows on the screen, you drag the icon and place it on a window border. When this is done, the windows' size automatically changes to accommodate both applications. If you drag the icon onto a horizontal

border, it divides the available space into two horizontal windows; similarly, dragging the icon onto a vertical border will split the screen into two vertical windows. This process can continue with any number of applications on-screen simultaneously, and at all times the entire screen is covered with no windows overlapping.

Window size can be adjusted by moving the borders or using a pull-down menu at the top right hand-corner of each window. Although this 'tiling' approach feels less intuitive in use, it does have its advantages: no windows are lost under piles of others, and at all times the screen is used to its best advantage.

The File menu contains, as you would expect, options to manipulate files. From here you can Run, Load, Copy, Get Info, Delete, Print and Rename files. Although it is possible to copy files using the click and drag method on the file name, I found this unnecessarily complex, involving the SHIFT key and numerous clicks on the mouse button. Performing most of the general housekeeping functions requires rather more knowledge of DOS than with GEM, although nowhere near the 'C>COPY PROG1.COM LEVEL1 PROG1.COM' level needed with PC-DOS. The View menu lets you organise the files displayed by name, date, size and kind, as well as in long and short form. Also from this menu it is possible to specify which files are displayed (for example, all .BAS files), a feature lacking on GEM. The Special menu is, again, a place for everything else. From here you can create and change directories, format disks, create system disks, set the volume name and quit Windows.

TopView is the least Mac-like of the three, being all text-based, and does not have a desk-top manager in the sense that the other two do. Basically, TopView allows you to run applications within windows and adds a number of

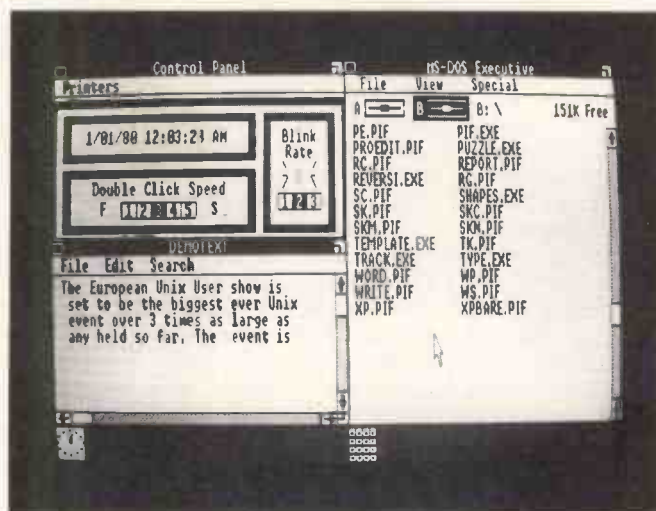

Microsoft's Windows running three applications

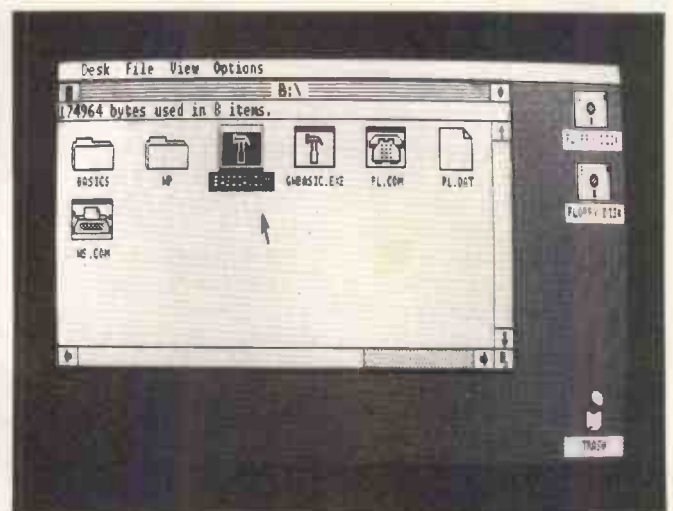

GEM's desk-top

menus to control this; options are chosen by using a mouse. Upon loading TopView, you are greeted by the 'Start-a-program' menu in the top right-hand corner of the screen. From this you can select and start any application you have informed TopView about, or alternatively select an option called DOS Services.

When an application is started, a click on the relevant mouse button (it varies depending whether you have a one, two or three button mouse) will bring up a small menu offering the following facilities: Scroll, Window, Scissors, Help, Suspend, Quit, Switch, Programs and Exit. Selecting Window will allow you to close in a window around the application, and here the first of TopView's bad points becomes apparent—the mouse control is awful. The window is really unstable, whether you're trying to move it or size it. To accurately position the window, you need good timing on the mouse button; press when you see the window where you want it and hope it doesn't flutter away. Perhaps I'm being unnecessarily critical, but after using Windows and GEM it does seem that bad.

The second problem I encountered was when scrolling a document within a window with the mouse. I thought I would have to pick up the document and move it around within the window, but TopView moves the window over the document so you move the mouse in the opposite direction that you would expect to go within the document. The Scissors option goes to a sub-directory from which you can cut, copy and paste text from one window to another, provided the applications to be utilised in this way display text in a normal manner. The options Scroll, Help, Suspend and Quit all operate on the current window in a similar fashion, sometimes through sub-menus, sometimes direct.

The options Switch and Programs are used to bring up multiple windows. To begin another application in a separate window, you select Programs with the mouse and click the appropriate button.

TopView then overlays the Start-a-program menu onto your screen. You select the program you want to run and click the left-hand mouse button, the application starts and you can use it as normal. You can now either select the Switch option to flick back to your original application, or size the window of your new application to fit on the same screen.

DOS Services brings up a screen with two menus, one containing the commonly-used DOS commands and a second containing a directory. With this you can select a file from the menu and select one of the DOS commands to perform on it. Other DOS commands can be applied with a second menu, but I was a little perturbed to find some functions, such as CHECKDISK, missing. This menu-driven method doesn't really shield you from DOS, it just makes applying the command easier.

Applications software

All three packages, running on an IBM PC, should run your existing IBM software, and no application I tested totally failed on any one of them. The question to be asked is: how well do they cope with running them within their respective windowing environments?

GEM makes no attempt to support an existing application within its windows. Double-clicking on such an application results in the screen going black and your application taking over in its normal fashion. GEM then just sits there in the background, waiting patiently until your application finishes. However, at the time of writing, Digital Research had GEM Write, Paint, Draw, Graph and Wordchart available; all programs run to the GEM standard, and the two I've seen, GEM Paint and GEM Write, seem very near to the quality set by their Macintosh equivalents.

Before going on to the way TopView and Windows cope with current applications, it's worth explaining the dilemma they face. Applications software for the IBM PC has outgrown PC-DOS and IBM's original BIOS—the

two areas where this is most critical is in handling the screen and the keyboard. Packages such as Lotus 1-2-3 and Flight Simulator write directly to the full screen and read directly from the keyboard, and obviously there's no way that a package that thinks it has the full screen to control directly can be forced to perform within a window. Packages such as these have been labelled 'badly behaved', and the best we can expect is to be able to switch from them to the desk-top, leaving the application inactive in RAM.

Both TopView and Windows approach this problem in the same way, by including PIF (Program Information Files) for most popular applications, as well as a general-purpose PIF that can be used to create your own for applications not included. If you have any doubts about an application of your own that you particularly want to run in a window, I advise you to see it running at a dealer's before buying either package, as these PIF files can get quite complex.

Both TopView and Windows claim to be able to run well-behaved programs within a window, but in fact TopView was the only one that I was able to do this on. This, I was told, is attributable to the pre-release version of Windows I was using, and will be correct on the final version. Both programs were able to run a well-behaved program on a full screen and then return to the desk-top with the application ticking away in the background. With badly-behaved programs, TopView refused to let me access any of its menus until I'd quit the application. Windows, however, returned to its desk-top with certain programs but not with others. My advice, therefore, is not to expect an old application to run other than by itself and by taking up the whole screen, and then you won't be disappointed. In fact an older package, Desq (reviewed in December 1983) is the best at integrating existing PC-DOS applications.

Concurrency

IBM's TopView and Microsoft's Win-

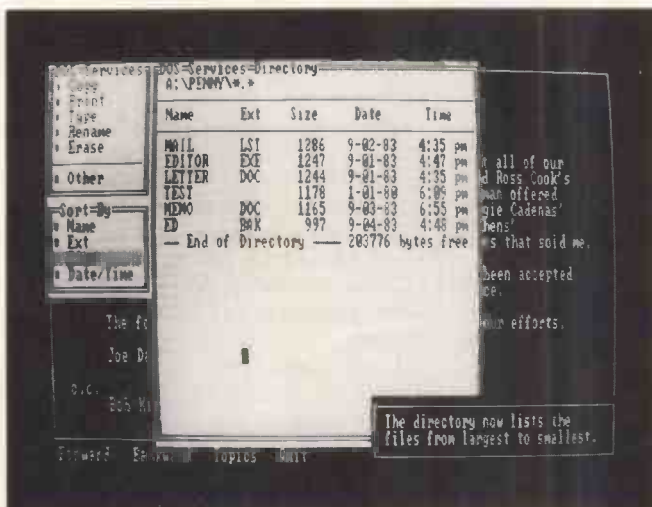

TopView's window-driven DOS Services

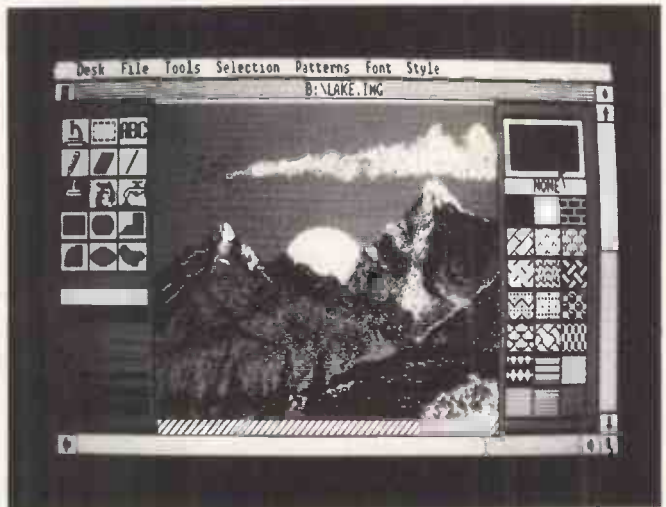

An example of GEM Paint

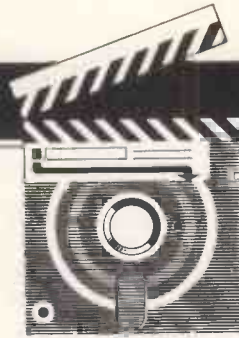

SCREENTEST

dows both add concurrency of a sort to good old MS-DOS. GEM doesn't, but there is no reason why it won't work with a multi-tasking operating system, and it is planned to work with Concurrent DOS 286 when it becomes available from Digital Research.

Concurrency is the ability to run applications programs simultaneously. Many programs seem to do this, such as the current spate of desk-top managers (see *PCW March*), but when you call a desk-top manager the application underneath stops running while you use the desk-top facilities. True concurrency has a number of programs running at the same time, with the processor sharing its time between them, so you can be printing from a word processor, recalculating a spreadsheet and reading your electronic mail simultaneously. Although there is no doubt that a PC with 512k can do this, it really is all too much for the old 8/16-bit processor architecture and can't be regarded as smooth with Windows or TopView. To get the most out of this concurrency, you really need a PC/AT or one of its equivalent high-performance clones.

The sight of TopView trying to run just two applications simultaneously on a PC is pitiful. Even when running a single application, the overhead needed to support multi-tasking slows it down to an almost bearable level. And given the power of the AT, TopView is apparently not particularly spectacular. One user I spoke to said: 'It's slowed my AT down to the speed of the PC.'

Windows makes a better attempt at concurrency, and when it was running the small demonstration programs I was very impressed. Certainly the friendly environment of Windows makes it easy to use the power of concurrency, and having lots of 3D rotating cubes, clocks and graphic demonstrations looks impressive, but when running serious applications the same speed problems arise. Overall, Windows copes better, and given the power of an AT, it would be an excellent package for productively using concurrency.

Both TopView and Windows define a standard for the implementation of concurrency, and it will be interesting to see which one will be taken up by the software houses. Given the might of IBM, it seems probable that even if TopView doesn't catch on in a big way, it will set a standard for concurrency. On the other hand, Microsoft wrote PC-DOS and will shortly be releasing a concurrent version, Version 4. When this happens, the concurrent part of Windows will be removed and the system will be marketed to run under this new operating system.

One other important fact sets Windows apart from the other two — the

use of a virtual memory system. The first versions of Windows gobbled up vast amounts of memory and ran very slowly, and although the speed problem was cleared up, the size of the thing required a different approach. Microsoft's solution was to make the memory management virtual in order that most of the system sits on disk and is only called when required. This virtual memory management system can now be used with applications written for Microsoft Windows, which means that there is effectively no limit to the amount of memory an application can

'A good desk-top should be easy to use and yet unleash the full potential of the system underneath. In particular, it should shield you from the complexities of DOS...'

use, thus breaking the 640k barrier that has previously existed for IBM applications. It also means that Windows consumes the least RAM of the three packages and will have most of it available for applications.

Windows and GEM both run quite happily in 256k RAM, with a reasonable amount of space available for applications. TopView will run in 256k, but there is practically no space left for applications so I suggest a minimum of 512k. To get the most out of all three packages, I'd also recommend a hard disk — with floppies you really need to keep the system disk in drive A, leaving drive B for both data and the applications disk. All three will work without a mouse, which is an attempt to persuade users not to fork out the £150 needed to buy one, but you'll soon find keyboard operation infuriating.

With a higher-resolution colour card, GEM and Windows will both operate in colour; TopView has colour menus with the ordinary PC Colour Board.

Prices

All prices are for the IBM PC versions (which are the ones I tested), and all three packages should be available by the time you read this — GEM is already available as I write. GEM Desk-top costs

£149.95 by itself, but is also available bundled in with GEM Draw at £129.95 and as part of the GEM Collection (including GEM Paint and GEM Word), also at £129.95. TopView costs £156 including a tutorial disk. A price for Windows hadn't been fixed at the time of writing, but it is expected to be under £100 including a bundled Paint program and other smaller utilities.

Conclusion

Notwithstanding the fact that IBM is the manufacturer of TopView, there is no doubt in my mind that it has lost this battle before it's begun. It could be argued that TopView was never intended to be a competitor, and to some extent those arguments are sound, but it does perform an essentially similar function to GEM and Windows, using windowing techniques and a mouse. TopView is the most expensive of the three, it needs the most from its host computer in terms of power, and offers the least back in return. TopView in no way makes the IBM PC as easy to use as a Macintosh: it merely adds concurrency to PC-DOS in a more friendly form.

A point in its favour is that it is designed to work with well-behaved PC-DOS programs, and doesn't rely for success on a graphics standard being accepted by software houses. But that old PC-DOS/IBM BIOS combination is looking old and jaded now, and most applications don't conform to it. Both GEM and Windows set new standards that are comprehensive enough to support advanced applications, and allow these applications to be easily transported between different machines.

It is much more difficult to choose between GEM and Windows — both packages are excellent and both have different merits. If you are a seasoned IBM user looking for more power and a friendly interface, I'd recommend Windows for its concurrency and virtual memory. If, however, you are an occasional or new user, you will probably find GEM the friendliest and easiest to use. Both are a great step up from MS-DOS.

Digital Research was the first to get a foot in the market, and has used the time to sign up as many manufacturers and software houses as possible. Windows has the advantage of coming from Microsoft which produces PC-DOS, and so will be better placed to deal with any changes in this operating system.

I see GEM and Windows selling alongside each other for some time before any clear winner will emerge. To make a real impact on the market, both packages need to sell to computer manufacturers to be bundled with machines, and it's here that the real battle will be fought.

END

LOOKING FOR SOFTWARE?

- * We hold a library of information on Software & Hardware.
- * This library contains detailed information on business software for micros and minis.
- * You can use it as a single impartial source of information to assist you finding the correct equipment.
- * Our computer will list all the options that fit your requirements so you can be satisfied you have made the right choice.
- * Once we have found what you're looking for we can then put you in contact with a supplier who is qualified to show you the software & hardware working.
- * We can also assist you in finding peripherals, communications equipment, leasing, maintenance, training, and computer office furniture.
- * OUR SERVICE IS FREE AND IS DESIGNED TO SAVE YOU TIME AND ENERGY IN UNNECESSARY RESEARCH.
- * Phone this number and we will help you find the software & hardware you need.

**SOFTWARE
INFORMATION
LIMITED**

**01-831-0071
(Five lines)**

All in the chip

Peter Van Linden and Steve Talbot reveal details of a previously secret Japanese project to develop a specialised compiler chip which acts as a language translator.

Over the last two years, the Japanese have mounted a major initiative aimed at establishing supremacy in advanced computer technology. This is the ICOT venture, a joint partnership between the Japanese government and organisations such as Mitsubishi, Fujitsu and Hitachi. ICOT is a concentrated research programme which the Japanese hope will put them far ahead in the fields of VLSI (Very Large Scale Integrated) circuits and software.

Every country that likes to think of itself as a major force in electronics, including the US, the UK, France and Germany, has put together a research effort in response. In the US there are several such programmes, including

one directed at Very High Speed Integrated Circuits, while in the UK the Alvey research effort is being funded at the level of £350 million over five years. Such a response is all very well, but it remains to be seen whether our research efforts will produce better results than those of our competitors. Certainly our universities have been starved and cut off from desperately-needed funds over the past five years. Has a large enough supply been restored in time?

Japanese research

All research and development activities are usually shrouded in the utmost secrecy — there's no sense in letting

your rivals have advance warning of your best ideas! Even so, there have been tantalising rumours of Japanese efforts to develop a compiler in hardware, on a single integrated circuit. Very little hard information has been previously available, but this article reveals some of the most important technical secrets of the project. A couple of Japanese engineers working on the project announced details of their work in an obscure and sparsely attended technical symposium last year. We have been able to piece together their approach from details of their presentation, a close knowledge of the subject, and information from other sources.

There are several reasons for developing a specialised chip which acts as a language translator. Specialised chips have always been used to supplement computer systems, often dealing with graphics, for instance. But up to now, the job of translating programming language statements into machine code has always been done by software, and that means it has all the attributes of software: compilers are slow, unwieldy, bug-ridden and easy to pirate. A hardware version of a compiler would be fast, compact, difficult to pirate, and perhaps even bug-free. If the Japanese were successful in making a compiler chip, it would convincingly demonstrate that they had achieved technological superiority in VLSI design over the Americans. It would confirm the trend of improving system architectures by putting more smartness into hardware. But most importantly, the compiler chip would help enormously to reduce the workload of ageing mainframes, minis and even micros.

Performance boost

Just imagine a compiler chip inside your workstation or personal computer. Resource-intensive compilations could be done without hogging the system, and these compilations would be speeded up by perhaps 1000 times. What's more, compilers are closely related to interpreters. If a Basic compiler chip can be built, then it would surely lead to the obvious development of an

	Implementation method	Typical speed
Supported in RAM or ROM	High-level language	milleseconds
	Assembler	10 ⁻⁵ seconds
Software/hardware boundary	Machine code	10 ⁻⁵ seconds
	Microcode	10 ⁻⁷ seconds
Visible only to computer designer	Logic gate	10 ⁻⁸ seconds
	TTL devices	nanoseconds
	Electrons	C (speed of light)

Like any physical system, a computer system can be described in terms of layers. Each layer is complete and consistent in itself.

A layer builds more complex and powerful functions out of the operations available from the layer below it. This way of looking at computer architectures applies to all processors, from the Intel 8088 to mainframes like the Cray II.

The lower down the hierarchy you can implement a given function in a computer, the faster it will operate. But it also becomes much more costly to build, and much more difficult to change.

Fig 1 Hardware/software trade-offs

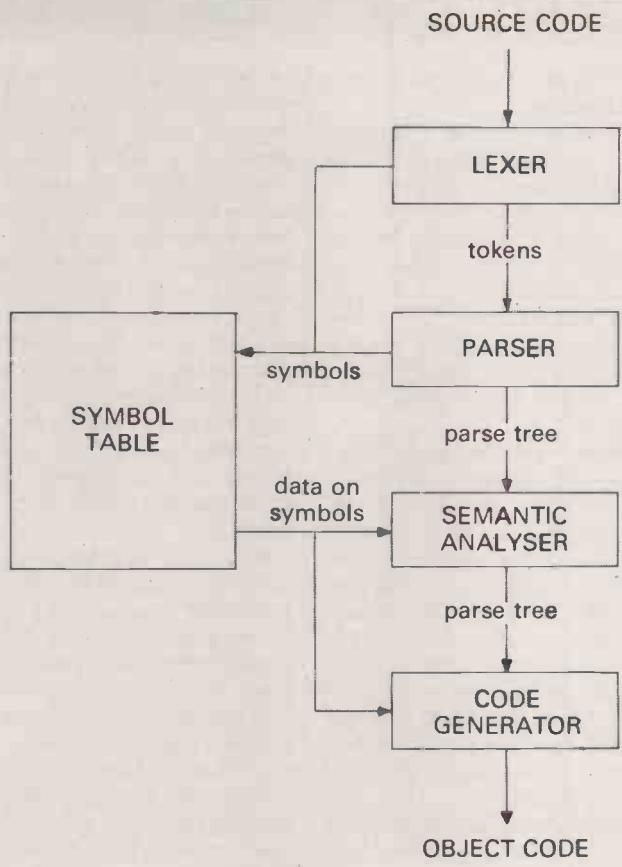

Fig 2 The components of a compiler

interpreter chip. And just think what a thousand-fold speed-up in execution would mean for your Spectrum or other popular micro.

The Japanese don't claim to have built such a device yet. What they have constructed is a detailed design of the compiler chip, together with a program which simulates its operation. When we first heard the rumours of the compiler chip, we guessed that it would probably rely heavily on microcoding: that is, the functionality would not be designed at the level of the logic gates which comprise integrated circuits. That would be like trying to build a house by mixing the cement in an egg-cup; theoretically it could be done but it would be very fiddly and take far too long. The Japanese design, we guessed, would be at the next implementation level, in microcode.

Microcode is a very low-level machine language which is normally only visible to the architects of a computer system, it differs from binary machine code in that it operates directly on the very low-level hardware. The instruction set of a computer is usually implemented by a series of microcode operations which are invisible to the user or programmer. For example, a single assembly language instruction 'load accumulator' might be implemented by a series of several microcode instructions, such as 'fill address register', 'enable address lines', 'latch memory buffer', 'fetch from memory' and 'transfer buffer to accumulator'. Each of these low-level

operations is very fast, and there is scope for several of them to occur concurrently. A compiler implemented in microcode on an integrated circuit would thus be far faster than one

implemented in assembler or other software. The microcode instructions would in turn be implemented by TTL logic circuits (Fig 1).

The prediction of a microcode rather than logic gate implementation for the compiler-on-a-chip turned out to be correct, although the engineers chose a programmable logic array design rather than extensive custom-designed firmware. That is, they tried to use existing hardware building blocks which were close to what they required, rather than design wholly original chip sets from scratch. The complexity of a true VLSI compiler, designed in logic gates, is still way beyond the current state of the art, so the chairmen of Intel, Motorola and Texas Instruments can sleep easy in their beds a while longer.

We also guessed that the compiler would probably translate one of the smaller programming languages, possibly a simple language of Japanese design, but in reality the Japanese engineers were rather ambitious and selected Pascal as the source input for their compiler. The object code output was a machine-independent pseudo-code, suitable for execution on a range of different hardware.

How a compiler works

The classic way to break down the work of a compiler is to split it into four functions, namely lexing, parsing, semantic analysis and code generation. The first two build up information about a program and store it a symbol table; the last two phases make many references to the symbol table and use the

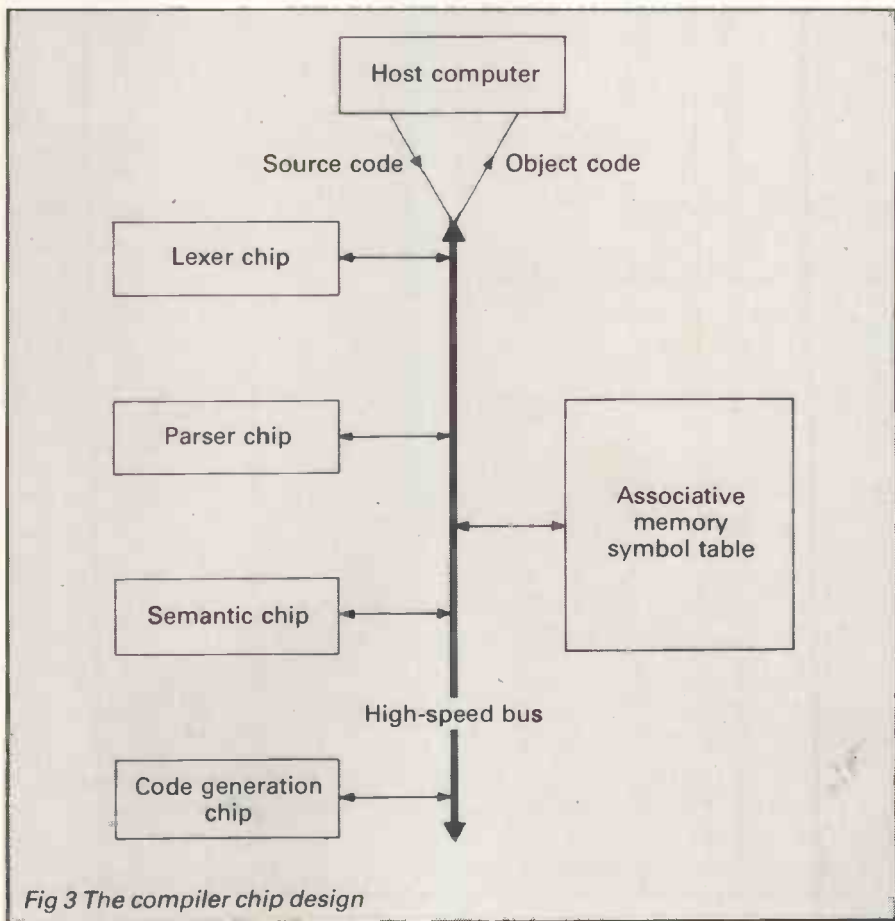

Fig 3 The compiler chip design

information stored there (Fig 2).

The lexer routines will read the file containing the source code and pass on tokens (individual words or symbols) to the parser. The parser's job is to examine the phrases passed to it by the lexer and check that the sequences form a legal program. In Basic, for example, you normally expect an identifier to follow the keyword 'LET' (as in 'LET A = 10'), so the parser would complain if it found anything else there (a constant or a keyword, for instance).

The parser builds up a large data structure of all the tokens and various information about each. This structure, often called a 'parse tree', is given to the semantic analyser to make sense of. The semantic analyser will check that the operations requested in the source code make sense in terms of the operands given, so LET A\$ = A\$ + 10.5 is obviously wrong as it doesn't make sense to add a floating point number to a string variable.

The code generator will follow on from the semantic analyser to create and output the machine code corresponding to the source. There may also be a separate code optimisation

phase, but this can be ignored for the purposes of simplicity.

During lexical analysis and parsing, the compiler builds up a symbol table for the source program. In the semantic analysis and code generation phases, the symbol table is searched for information about the various tokens: for example, 'Is the identifier 'X' an integer, character, or real number?', or 'How many bytes does 'X' need, and what is its address?'. The interaction between the various stages of compilation is shown in Fig 2.

The Japanese have designed 'logic engines' (special-purpose chips) which carry out the same processing described here, previously done by software. Therefore, their compiler chip set is actually four chips, splitting the compiler design in the conventional way: a lexical chip, a parsing chip, a semantic analyser chip and a code generator chip. There is also some local storage on the silicon, and an associative memory to hold the symbol table. The component chips are connected by a common bus (Fig 3).

The really clever achievement of the Japanese is to realise that these four

components are, to a great extent, independent. The lexer chip can read in the next token, at the same time as the parser chip is examining the present one. Similarly, the semantic analyser can evaluate the next part of the parse tree while the code generator is generating code for an earlier part. As these phases are largely independent, they can operate in parallel (at the same time as each other). As a chip completes the processing of an input token, it places an output token on the bus for the next chip in line to operate on. This leads to worthwhile performance improvements, and is theoretically possible in software but difficult to achieve in practice.

However, overlapping the work of different modules like this is a common hardware ploy, and is known as 'pipelining' (Fig 4); this is widely used in the fastest processors available today. The Cray 1 uses pipelining in its arithmetic unit to overlap the different sub-tasks in division and multiplication, and to gain significant performance improvements. The compiler chip's pipelined mode of working achieves a degree of concurrency within the compilation, but limits the overall speed to that of the slowest component. The designers do not say which this is, but we think the lexical chip would be the slowest; compilers are almost always I/O bound.

The integrated circuit areas described by the Japanese engineers were large, but not impossibly so. The parser chip (which was the biggest) required a die size of about 6.1mm by 7.8mm, and it is already possible to fabricate chips of this size using existing VLSI technology. Again, it is impressive to note the use of associative memory for a symbol table. Associative memory is a special form of memory in which the contents are retrieved by specifying their value rather than their address, thus you can make an enquiry in the symbol table by giving the name of an identifier and receive back all the corresponding data describing it very quickly. The individual components of the compiler-chip system are connected by a high-speed custom-made bus.

What next?

As the compiler produces pseudo-code output, it would certainly be fascinating to connect one up to the Western Digital micro-engine which runs pseudo-code directly as its assembly language. This would probably comprise a system which was phenomenally fast at both compiling and execution. Certainly the Japanese have demonstrated the feasibility of a compiler or interpreter in hardware, but they are characteristically coy about whether the project is being continued through to producing a working prototype.

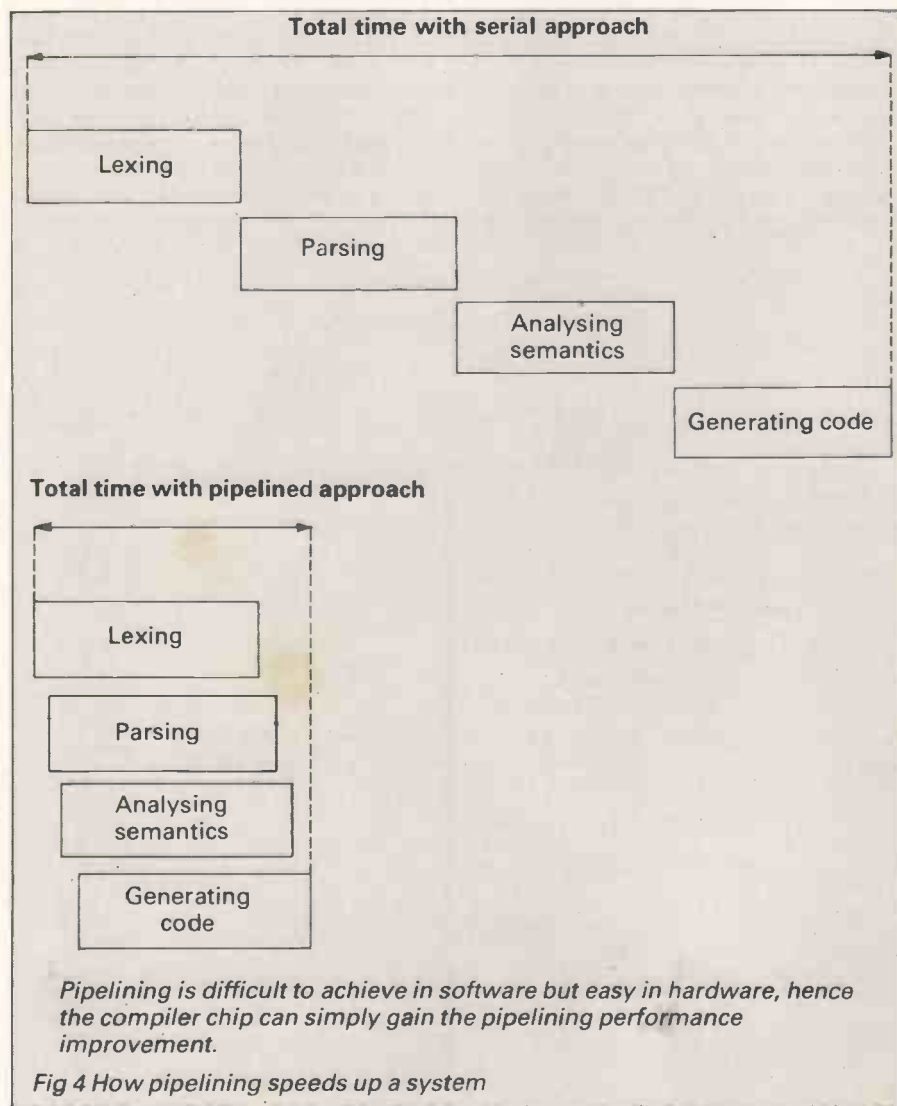

Just because you bought an IBM* computer, you don't have to miss out on the JUKI 6100.

It did seem a trifle unfair, after all. Because the JUKI 6100 quickly became one of the best-selling letter quality daisywheel printers in the UK.

So now we've introduced the brand-new JUKI 6100-I, which, as the suffix suggests, is IBM* graphic printer compatible. It has all the features of the original 6100, including graphic mode and full word processing support, yet it costs just £379 plus VAT. Another new release is the highly successful JUKI 6000. There aren't many letter quality daisywheel printers designed specifically for use at home.

The high speed JUKI 5520 dot matrix printer is a stunning example of high quality advanced technology at a remarkably low price. Complete with graphic mode, it's ideal for your personal computer, and even has an optional 4-colour print function.

See them all for yourself at your local JUKI dealer.

They may not have been out for long, but they'll be around for a good deal longer.

*IBM is a trade-mark of IBM Corporation.

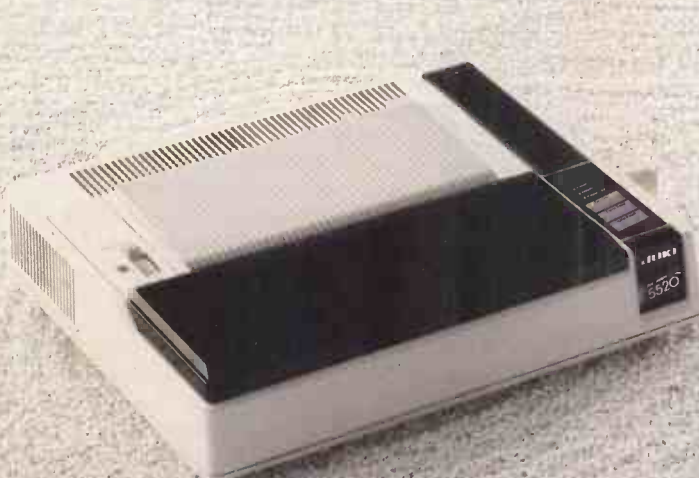

JUKI 5520



JUKI 6000



JUKI 6100-I

JUKI
Technology true to type

JUKI EUROPE GMBH, Effersb. 74, 2000 Hamburg 26, F.R. Germany
tel. 040 25420 | 73 Telex: 13 081 (JUK) Ca. (040) 251 124

Sole distributor: **Micro Peripherals Ltd**, Inspec Unit 2, Cassocks Wood, Wade Road, Basingstoke, Hants, RG 24 0NE
Tel. (0256) 47-3282 (32 lines) Telex: 859668 MICRO PG, Facsimile (0256) 467570

Visicode revisited

Software transmission via your TV and micro continues this month as John Billingsley applies the Visicode receiver to the Spectrum 48k and the Amstrad CPC464.

Visicode allows text and software to be transmitted as part of a television picture, and then to be captured with the aid of a simple circuit with a photocell, two transistors and a cheap logic chip. In *PCW* July, the details and software were given for receiving Visicode on the BBC Micro and the Commodore 64. Now the Visicode receiver is to be applied to the Amstrad CPC464 and the Spectrum 48k, enabling users of these machines to pick up the television-transmitted software.

The software will be broadcast on *Database* on Thursday nights throughout July. The show goes out at 10.30pm on Thames TV, but transmission times vary from region to region so check local details. To celebrate these first Visicode broadcasts, Micronet 800 is providing £2000 worth of prizes consisting of 30 free yearly combined subscriptions to Prestel and Micronet 800. To win, you have to solve a puzzle

which is being broadcast in text form during *Database* in four separate parts and all together at the end of the month.

Receiving transmissions

To receive the transmissions, you'll need a Visicode receiver unit and the receiving routines. In *PCW* July we published the software for the BBC and Commodore 64; this month it's the turn of the Spectrum 48k (Fig 1) and (with thanks to Jim Crowther) the Amstrad (Fig 2). I've also featured the Amstrad assembler version to encourage other Z80 implementations (Fig 3).

The receiver unit can be bought ready-built from Magenta Electronics, at £8.60 for the Amstrad and £13.98 for the Spectrum (or, for readers who missed last month's issue, £7.20 for the BBC and £7.10 for the Commodore 64). Full kits are also available from Magenta, including all components, case, drilled and tinned printed circuit board,

and building instructions. These kits cost £6.96 for the Amstrad and £10.68 for the Spectrum (£5.52 for the BBC and £5.44 for the Commodore 64). For readers with construction experience, details of the components and circuitry are also included in this article.

The components should be available at your local electronics store, but Magenta can supply any that you have problems finding (its prices are shown in Fig 4). In fact, the Amstrad version uses the same components as the BBC and Commodore 64 units.

Magenta's service is mail order only, and 60p should be added to each order to cover postage and packing (VAT is already included). Payment is needed with each order — a cheque, a postal order, Access or Visa is acceptable. Magenta's address is 135 Hunter Street, Burton-on-Trent, Staffs DE14 2ST, tel: (0283) 65435.

The circuitry for the Amstrad's receiver unit is shown in Fig 5 — again it is the same as for the BBC and the Commodore 64. However, the Spectrum's circuitry needed some extensions (Fig 6) which I will describe in detail, but first a closer look at the Amstrad version.

The Amstrad CPC464

The original suggestion for the Amstrad was to use the printer strobe and busy lines for coupling the Visicode receiver unit to the computer. This would work, but obtaining a printout would involve first saving the code on cassette, or performing a rather risky 'hot swap' of the connectors. A further deterrent was the lack of a five-volt supply pin on the printer port.

The expansion port has the necessary supply, but can the standard receiver unit be connected without additional interfacing? With a certain amount of deviousness, the solution is simple. When the Visicode receiver detects a spot on the screen, a bistable latch is set. The computer must be able to read the state of this latch, and must also be able to reset it ready for the next scan line. Connected to pin 48 of the 50-pin expansion port edge connector is an input intended for detecting whether an expansion is really there, —EXP. This appears on bit 5 of input &F500. Nothing seems to go amiss

```

1 REM ** VISICODE RECEIVER ROUTINE FOR ZX-SPECTRUM VERSION M1 **
10 CLEAR 33791: REM top room
20 LET mc=254*256: LET p=33794: LET q=mc-256: LET r=p: GO TO 200
30 GO SUB 1000: PRINT "running"
35 LET m7=255: LET f=511: LET cu=341: LET tu=292: LET qu=63
40 LET a=USR mc: LET a=USR mc: LET a$=INKEY$
50 IF a<>tu THEN PRINT AT 6,0;"not happy": GO TO 40
60 IF a$<>"r" THEN PRINT AT 6,0;"ok, ": GO TO 40
70 CLS: PRINT "ready to receive": LET a=USR mc
75 LET a=USR mc: IF a<>cu THEN GO TO 75
80 LET a=USR mc: IF a>m7 THEN GO TO 80
90 FOR i=p TO q
100 POKE i,a: LET a=USR mc: IF a<=m7 THEN NEXT i: GO TO 200
110 IF a<>f THEN LET a=qu: NEXT i: GO TO 200
120 LET r=i: LET i=q: NEXT i
150 CLS: FOR i=p TO r: PRINT CHR$(PEEK(i)): NEXT i
200 PRINT: PRINT "RECEIVE,PRINT,SAVE,LOAD OR VIEW"
210 INPUT "R,P,S,L or V ? " : ia$
220 IF a$="p" OR a$="P" THEN FOR i=p TO r: LPRINT CHR$(PEEK(i)): NEXT i: LP
RINT
230 IF a$="r" OR a$="R" THEN GO TO 30
240 IF a$="v" OR a$="V" THEN GO TO 150
250 IF a$="s" OR a$="S" THEN POKE p-1,INT(r/256): POKE p-2,r-256*PEEK(p-1):
SAVE "TEXT"CODE 33792,r-33791
260 IF a$="l" OR a$="L" THEN CLS: PRINT: PRINT: PRINT "POSITION 'TEXT' TAPE
": PRINT: PRINT "AND PRESS PLAY": LOAD "TEXT"CODE: LET r=PEEK(p-2)+256*PEEK(p-1)
270 GO TO 200
1000 RESTORE: LET i=mc: CLS: PRINT "loading machine code"
1005 PRINT: PRINT "when ok,press r to receive"
1010 READ c$: IF LEN(c$)<>16 THEN RETURN
1015 FOR j=0 TO 7: LET a$=c$(2*j+1): LET b$=c$(2*j+2)
1020 LET a=CODE(a$)-48-39*(a$>"")
1030 LET a=16*a+CODE(b$)-48-39*(b$>"")
1040 POKE i+j,a: NEXT j
1050 LET i=i+8: GO TO 1010
2000 DATA "f3d37f1e08160815"
2010 DATA "ca32fedb7fb7f20b"
2020 DATA "fe0603cd3bfecd38"
2030 DATA "fefao7fecdc38fef2"
2040 DATA "07fecdc39fe1dc222"
2050 DATA "fecdc39fecb11cb10"
2060 DATA "fbc9067f0efffb4c9"
2070 DATA "05060a10fedb7fd3"
2080 DATA "7f17cb1979d3fec4"
2090 DATA "xxx"

```

Fig 1 The Spectrum receive routine

```

10 GOTO 10000
90 CLS:PRINT "Adjust photocell until OK":PRINT "Press <space> to receive VISICODE"
100 CALL mc:CALL mc:a$=INKEY$:SOUND 1,PEEK(by)/(1+PEEK(ct)),1
110 IF PEEK(by)<>tu OR PEEK(ct)<>1 THEN LOCATE 1,5:PRINT "NOT HAPPY":GOTO 100
120 IF a$="" THEN LOCATE 1,5:PRINT "OK,";GOTO 100
125 CLS:PRINT "Waiting for start code":CALL mc
130 WHILE PEEK(by)<>cu OR PEEK(ct)<>1:CALL mc:WEND
135 CLS:PRINT "Receiving":i=10:CALL mc
140 WHILE PEEK(ct)>0:CALL mc:WEND
150 WHILE (PEEK(by)<>ff) OR (PEEK(ct)<>1):POKE i,PEEK(by):i=i+1:CALL mc:SOUND 1,
PEEK(by),1:WEND
160 r=i+1:POKE r,&FF
300 CLS:LOCATE 1,1
310 PRINT "1 Save text to tape"
320 PRINT "2 load text from tape"
330 PRINT "3 View text"
340 PRINT "4 Receive VISICODE transmission"
350 PRINT "5 Print text"
360 a$=INKEY$:IF a$="" GOTO 360
365 IF a$=" " GOTO 360
370 IF a$="1" THEN INPUT "Filename ";f$:SAVE f$,B,10,r-1:GOTO 300
380 IF a$="2" THEN INPUT "Filename ";f$:LOAD f$,10:r=10:WHILE PEEK(r)<>&FF:r=r+1:
WEND:GOTO 300
390 IF a$="3" THEN s=0:D=0:GOTO 430
410 IF a$="4" THEN GOTO 90
420 IF a$="5" THEN s=8:D=0
425 GOTO 300
430 FOR i=10 TO r-1:PRINT#s,CHR$(PEEK(i)); IF PEEK(i)=&D THEN PRINT:D=D+1:IF D=2
4 THEN WHILE INKEY$="" :WEND:D=0
440 NEXT
450 GOTO 300
10000 p=10:MEMORY &1FFF:mc=&2000:by=&2080:ct=&2081:10=&2100:hl=&AB7F
10010 tu=&24:ff=&FF:cu=85
10020 i=mc:PRINT "Loading machine code"
10030 READ j:IF j<256 THEN POKE i,j:i=i+1:GOTO 10030
10040 GOTO 300
10100 DATA &F3,&11,&0B,&04,&21,&00,&C0
10110 DATA &01,&00,&7F,&3E,&85,&ED,&79
10120 DATA &15,&CA,&3F,&20,&06,&F5
10130 DATA &ED,&7B,&CB,&6F,&2B,&FA
10140 DATA &06,&01,&CD,&4B,&20,&CD,&45,&20
10150 DATA &FA,&0E,&20,&CD,&45,&20,&F2,&0E,&20
10160 DATA &CD,&46,&20,&1D,&20,&FA
10170 DATA &CD,&46,&20,&CB,&15,&26,&00,&CB,&14
10180 DATA &22,&80,&20,&FB,&C9
10190 DATA &21,&7F,&7F,&C3,&3A,&20,&05
10200 DATA &06,&09,&00,&00,&00,&10,&FE,&06,&F5,&ED,&37B
10210 DATA &46,&87,&87,&17,&CB,&1D,&L9,9999

```

Fig 2 The Amstrad receive routine

when the Amstrad is powered up with this pin pulled low, so half the problem is solved.

How can the latch be reset? On pin 42 of the connector is —ROMEN, which is pulled down to zero volts each time the ROM is accessed. This is every few microseconds when Basic is running, but a machine code program in RAM need not call the ROM at all until it exits. Now all that is needed is a memory read from ROM and the latch will be cleared, but unfortunately this is not quite so easy.

In order that the user's machine code can have plenty of space, the Amstrad system disables both halves of the ROM when executing a Basic CALL. To get the —ROMEN line to respond, it is thus first necessary to re-enable the top ROM—the work of a byte or seven of machine code. From then on it is plain sailing. Ground is found on pin 49 and —5 volts on pin 27. (Note that the connector has odd numbers on the top and even numbers below.) You need no more than the standard Visicode receiver unit and a 50-pin 0.1in edge connector — and of course the receiving software.

The Amstrad receive routine will automatically protect an area of memory above location 8191 in which it plants the machine code, and where the received text is stored. Each time the machine code is called, execution hangs up until the photocell receives a spot. It tests it for the right header stripe, reads the byte and saves the result in 8320. If there is an extra control stripe, 8321 is set to 1, while if the header is

faulty 8321 is made 127.

When the program runs, it takes a couple of seconds to plant the code and

then enters a test mode. Each time the spot is seen, its value is tested for &24 plus control stripe. A repeated 'ping' from the sound channel indicates the received code, and if it does not match &24 then the screen shows 'Not happy'. Only when 'OK' is shown will the computer accept a tap on the space bar, and move to the next stage.

The program now waits for a 'U' code with control bit set. In future, software can be sent in a succession of blocks for a variety of machines. Each machine will wait for its own code before loading — 'B' for BBC, 'A' for Amstrad, but 'U' indicates a text file which is universal. At last, the string of control codes comes to an end and the machine can start to load data.

To indicate that the data is being saved, the sound generator gives a pip as each byte is received, chirruping with a variable pitch. There is no test for buffer size, but the memory can hold over 10 minutes of continuous data. When a final &FF plus control is received, the captured text is listed to the screen.

The Spectrum 48k

And so to the Spectrum. First the good news — the Spectrum can receive Visicode. The bad news is that you will need a 48k version to do the job correctly. The trouble, as described last month, is in the timing of the loop which tests each line of the transmitted spot.

I owe Sinclair Research something of

Machine code for Amstrad.

Locate machine code at &2000 above HIMEM.
Save byte in &2080, control in &2081

Data is read through (exp) line of expansion port,
latch is reset by ROM select line.

```

2000 F3          START  DI          ;Disable ints
2001 11 08 04   LD  DE +0408      ;D=tries, E=count
2004 21 00 FF   LD  HL +FF00      ;L=result H=control
2007 01 00 7F   LD  BC +7F00      ;point to gate array
200A 3E 85     LD  A, +85        ;enable upper ROM
200C ED 79     OUT (C),A        ;disable lower.
200E 15       AGAIN  DEC D        ;tries ?
200F CA 3F 20   JP  Z, GIVUP      ;too many.
2012 06 F5     LD  B, +F5        ;For input
2014 ED 78     SYNCH  IN  A, (C)      ;read to bit 5
2016 CB 6F     R11  A, 5        ;test bit 5
2018 2B FA     JR  Z, SYNCH    ;wait until start bit.
201A 06 01     LD  B, +1        ;half line delay
201C CD 48 20   CALL DAWDLE      ;and clear latch.
201F CD 45 20   CALL GETSLO     ;line 2
2022 FA 0E 20   JP  M, AGAIN     ;was set, wrong.
2025 CD 45 20   CALL GETSLO     ;line 3
2028 F2 0E 20   JP  P, AGAIN     ;not set, wrong.
202B CD 46 20   LOOP  CALL GETBIT ;now for data.
202E 1D       DEC  E        ;count bits
202F 20 FA     JR  NZ, LOOP    ;more
2031 CD 46 20   CALL GETBIT     ;control?
2034 CB 15     RL  L          ;fix L
2036 26 00     LD  H, +00      ;H will be 0 or 1
2038 CB 14     RL  H          ;control to H b0
203A 22 80 20   SAVE  LD  (2080),HL ;save result.
203D FB       EI          ;enable ints
203E C9       RET         ;back to Basic.

203F 21 7F 7F   GIVUP LD  HL, +7F7F ;error code
2042 C3 3A 20   SAVE  JP          ;go home

2045 05       GETSLO DEC  B        ;dummy for timing
2046 06 09     GETBIT LD  B, +9   ;delay count
2048 00 00 00   DAWDLE NOP,NOP,NOP ;timing fine tune
204B 10 FE     D1      DJNZ  D1      ;wait loop
204D 06 F5     LD  B, +F5      ;for input
204F ED 78     IN  A, (C)      ;read latch bit 5
2051 46       LD  B, (HL)     ;ROM clears latch
2052 B7       ADD  A        ;to bit 6
2053 B7       ADD  A        ;latch to bit 7
2054 17       RLA         ;then to carry
2055 CB 1D     RR  L          ;mix with result.
2057 C9       RET         ;subroutine end.

```

Fig 3 Assembler version of the Amstrad receive routine (for reference only)



LOOK

If you were a

COMPUTACLUB

member

you would be entitled to:

15% discount off all Amsoft Software

10% off KORES® Ribbons

10% off 1000 LABEL-TRACK® Computer Labels

3" MAXELL® Compact Disks **£39**

3M 5 1/4" Discs at Trade Prices

S/S D/D **£14.45** S/S Q/D **£21.90**

D/S D/D **£19.60** D/S Q/D **£25.35**

All prices include VAT and Postage

All orders despatched on day of receipt

SUBJECT TO STOCK AVAILABILITY

Plus **SPECIAL OFFERS EVERY MONTH**

Annual membership fee **£11.50**

For full details and an application form, write to

COMPUTATECH LTD

45 Plovers Mead, Wyatts Green, Essex CM15 0PS

THE ONLY £100 WORTH REMEMBERING.



HTE

Our range includes 6 different memory cards.

HIGH TECHNOLOGY ELECTRONICS LTD., 303/305 PORTSWOOD ROAD, SOUTHAMPTON, SO2 1LD. TEL: (0703) 581555 TELEX: 477465 HTEL G.



MM

PC PRICE BONANZA

PROFESSIONAL SERVICE

EXPERT ADVICE

PROMPT DELIVERY

PC SOFTWARE

CAXTON CARDBOX	£185
DBASE II	£240
DBASE III	£325
DMS DELTA 4	£350
DMS +	£155
DR FORTRAN 77	£199
DR PASCAL	£235
DR ASSEMBLER Plus Tools	£120
FRAMEWORK	£325
FRIDAY	£125
KNOWLEDGEMAN	£325
LOTUS 1 2 3	£299
MICROSOFT WORD	£240
MICROSTUF X TALK	£120
MULTIMATE	£295
MULTIPLAN	£125
MULTIUSER ACCOUNTS per Module	£295
OPEN ACCESS	£325
PEACHPAK	£150
PEGASUS LEDGER MODULE	£200
PSION EXCHANGE	£395
R. BASE 4000	£295
SAGE ACCOUNTS	£250
SAGE ACCOUNTS PLUS	£475
SAGE CHIT CHAT	£110
SAPPHIRE DATAMASTER	£395
SMART SOFTWARE SYSTEM	£495
SYMPHONY	£425
TK SOLVER	£245
TX FILE TRANSFER	£165
VOLKSWRITER DELUXE	£215
WORDSTAR	£190
WORDSTAR MAILMERGE	£95
WORDSTAR PROFESSIONAL	£245
WORDSTAR 2000	£290

Ex Vat.

PC PRINTERS

ANADEx DP-6500 500cps	£185
BROTHER 2024L 190cps (NLQ)	£240
CANON PW 1080A 160cps (NLQ)	£325
EPSON FX 100	£350
EPSON LQ 1500 200cps (NLQ)	£155
HEWLETT PACKARD LASER PRINTER	£2950
JUKI 6300 40cps	£749
MANNESMANN MT180 160cps (NLQ)	£529
MANNESMANN MT400 400cps (NLQ)	£1595
NEC 2050 20cps	£825
NEC 3550 35cps	£955
NEC PINWRITER P2(P) 180cps	£535
NEC PINWRITER P3(P) 180cps	£595
OKI 84A 200cps	£829
OKI 2350 (P)	£1435
OLIVETTI DM 5300E (P) 220cps	£815
OLIVETTI DY450 45cps (P)	£765
PANASONIC KX-P1091 120 cps + NLQ	£250
QUME 11/40 Ro + I/Face	£1345
RIcOH FLOWRITER 1600 46k	£1349
TEC STARWRITER F10-40 40cps	£830
TOSHIBA TH2100H 192cps (P)	£1280
TREND 930 200cps NLQ 80cps	£1350

STORAGE AND BOARDS

Pc NET STARTER KIT
PLUS 5 HARD DISK DRIVES FROM
512K MEMORY UPGRADES FROM
20MB TAPE STREAMER
AST, QUADRAM, HERCULES ALL AT HUGE SAVINGS

COMPLETE SYSTEMS SUPPORT AND TRAINING AVAILABLE.
FULL MANUFACTURERS WARRANTY.
MOST ITEM EX STOCK.
Next day insured delivery available.

Ex Vat.

PC's & COMPATIBLES

APRICOT PORTABLE 256K 1 x 720K Drive	£2295
APRICOT 256K 2 x 315K Drives & Monitor	£895
APRICOT 256K 2 x 720K Drives & Monitor	£279
APRICOT XI 256K 10MB & Monitor	£420
APRICOT XI 512K 20MB & Monitor	£895
COMMODORE PC10	£2950
COMPAQ 2 2 x 360K drives	£749
COMPAQ DESKPRO 640K 10MB	£529
COMPAQ PLUS 10MB	£1595
ERICSSON 256K 2 x 360K Drives	£825
ERICSSON 256K 10MB	£955
KAYPRO 286	£535
OLIVETTI M21 128K 2 x 360KB drives	£595
OLIVETTI M21 128K 10MB	£829
OLIVETTI M21 640K 10MB	£1435
OLIVETTI M24 128K 2 x 360KB Drive	£815
OLIVETTI M24 640K 10MB	£765
OLIVETTI 3B UNIX Range	£250
VICTOR 128K 1.2MB	£1345
VICTOR 256K 10MB	£1349
VICTOR 256K 2.4MB	£830
VICTOR VPc 256K 15MB	£1280
ZENITH 128K 2 x 360K	£1350

Ex Vat.

MAYFAIR MICROS

BLenheim HOUSE, PODMORE ROAD,
LONDON SW18 1AJ

TEL: 01-871 2555 / 870 3255

We accept official orders from UK Government and Educational Establishments. Mail Order and Export Enquiries welcome. Callers by appointment.

Ref: 1.01

Logo lists

Harvey Mellor continues his Teach Yourself series with a look at Logo list processing.

In its very earliest form Logo didn't have any graphics, and was exclusively concerned with 'list processing'. In fact, turtle graphics was originally thought of as a sugar coating useful for introducing programming to students, rather than as an end in itself.

In this article I'll explain what list processing is, and why it's important. There are other languages that are based around list processing — Lisp is the most well-known example, but Logo provides the easiest and best introduction to the topic.

To show how lists are used, I'll apply them to the task of developing the basic commands of a text adventure game. Lists have much wider applications than this, and future articles will explore other possibilities.

What is a list?

In Logo there are only two kinds of objects — 'words' (numbers are included in this category) and 'lists'. A list can be defined as 'an ordered collection of objects'. We mark the fact that something is a list by enclosing it within square brackets, so [SWORD KNIFE BAG STONE JEWEL] is a list, it is made up of five words. The word 'ordered' occurs in our definition because [JEWEL BAG SWORD KNIFE STONE] would be a different list from [SWORD KNIFE BAG STONE JEWEL]: the order matters.

Lists are important because they can be used to represent many different types of data. The aforementioned list was the inventory of an adventurer during an adventure game; the list [X = Y * Y] represents a mathematical formula; the list [TO BE OR NOT TO BE] represents a line of prose.

I said that a list was a collection of objects, not just of words, although the examples so far have been lists of words. A Logo object, remember, is either a word or a list, so our list could be a collection of lists. [[EDDY GRUNDY] [GRANGE FARM] [CAMBRIDGE]] is a list of three lists, and it represents an address.

A more complex example is [[:SIDE] [REPEAT 4 [FORWARD :SIDE RIGHT 90]]]. This is a list of two lists: the first list consists of one word; the second list consists of two words together with a list (which in turn consists of four

words). This list represents a Logo procedure for drawing a square.

These few examples should give you some idea of how useful lists can be for representing data. Logo provides a few simple primitives for manipulating lists, and with these you can write powerful programs working on complex structures of symbols.

A list (unlike an array in Basic) is not of any defined length, so you can add elements to it at any time until all the available memory in the workspace has been used up.

The Logo procedures using lists that we are going to develop could have been written in very different ways using Basic or assembly code, but using lists makes it easier to represent the data; this makes the data easier to think about, which in turn makes programming easier.

Taking lists apart

The basic operations for taking lists apart in order to examine them are FIRST and BUTFIRST.

FIRST [SWORD KNIFE BAG STONE JEWEL] returns SWORD, the first element of the list.

BUTFIRST [SWORD KNIFE BAG STONE JEWEL] returns [KNIFE BAG STONE JEWEL], the list without its first element.

One command needed in any adventure game is one to print out everything in the adventurer's possession — let's call this command INV for INVENTORY. We'll keep the possessions as a list, and assign it to the variable INVENTORY: MAKE "INVENTORY [SWORD KNIFE BAG STONE JEWEL]

We could then define INV as follows:

```
TO INV
  PRINT [YOU ARE CARRYING]
  PRINT :INVENTORY
END
```

If the adventurer does not have anything in his possession, then the line PRINT :INVENTORY prints a blank line; the list INVENTORY is said to be 'empty' and its value is represented as []. Logo provides an operation to test for this — EMPTY? (EMPTYP in LCS versions). Using this we can now improve on our procedure:

```
TO INV
  PRINT [YOU ARE CARRYING]
  TEST EMPTY? :INVENTORY
```

```
IF TRUE PRINT [NOTHING]
IF FALSE PRINT :INVENTORY
END
```

For some purposes it might be nice to have the possessions printed one under the other rather than along the same line. To do this, we need to replace the PRINT in the last line with a new procedure, PRINTVERT:

```
TO PRINTVERT :LIST
  PRINT FIRST :LIST
  PRINTVERT BUTFIRST :LIST
END
```

This procedure prints the first element of the list and then recursively calls itself, with the list minus its first element as its input. This causes each word to be printed one below the other. However, when the procedure gets to the end of the list, FIRST tries to find the first element of the empty list [], but there is no first element so Logo gives an error message. To overcome this problem, add a 'stop rule' to the recursive procedure:

```
TO PRINTVERT :LIST
  IF EMPTY? :LIST THEN STOP
  PRINT FIRST :LIST
  PRINTVERT BUT FIRST :LIST
END
```

PRINTVERT follows a pattern that is very common in recursive procedures: Compare it with this procedure which counts down from the input number to 0:

```
TO COUNTDOWN :NUMB
  IF :NUMB = 0 THEN STOP
  PRINT :NUMB
  COUNTDOWN :NUMB - 1
END
```

This procedure does not use list processing, but it shares the same pattern as PRINTVERT:

- 1) Test to see if the procedure is complete, if so then stop.
- 2) Deal with the easy case.
- 3) Call the procedure recursively to deal with a slightly simplified case.

This pattern is particularly common in list processing programs. It should not be surprising that many list processing programs use recursion, for even our definition of a list was recursive. Remember — we defined a list as a collection of objects, and yet we said an object was a word or a list!

Putting lists together

FIRST and BUTFIRST enable you to take

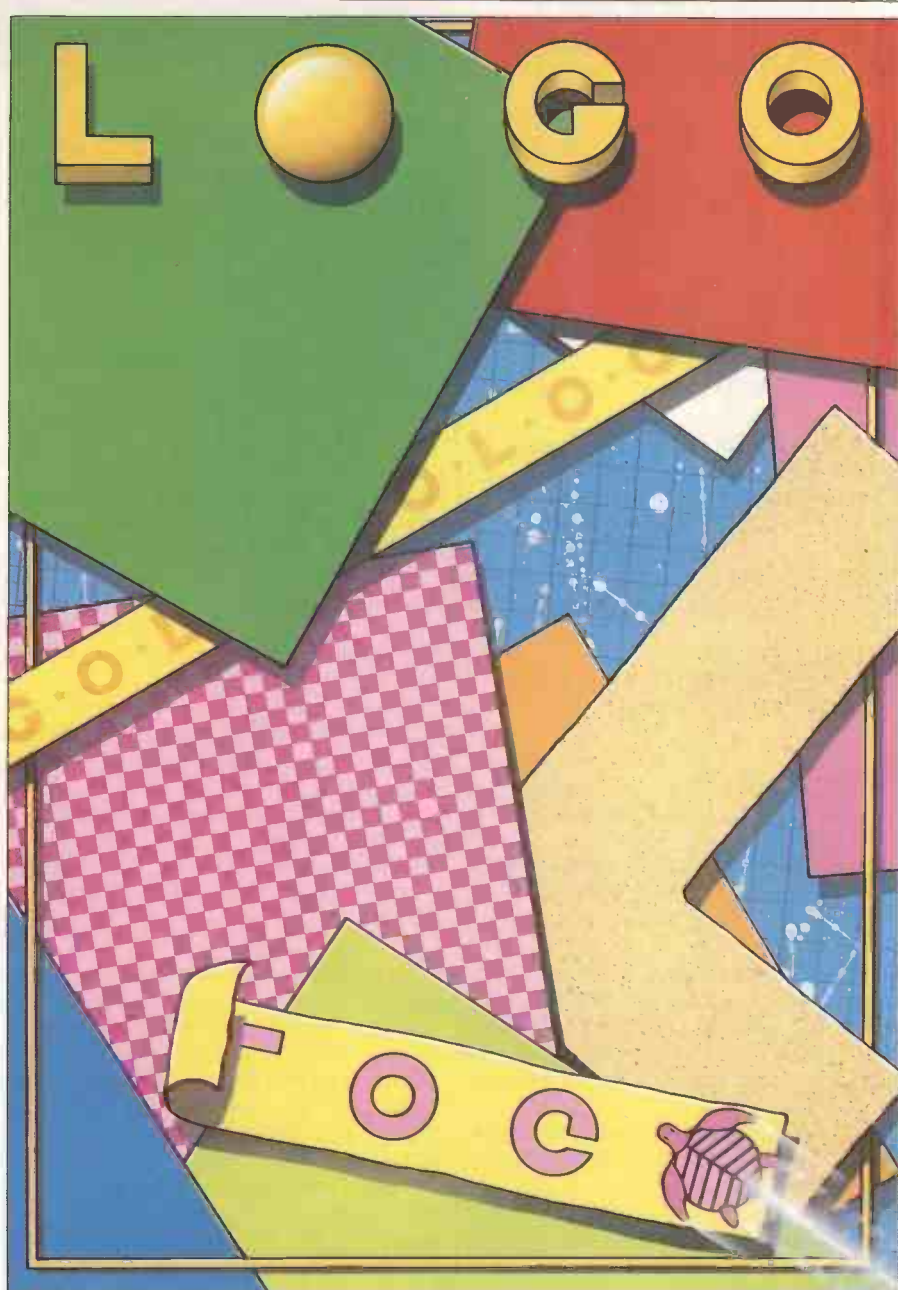

lists apart, to discover what is inside them. If you want to build up a list, the basic operation to use is FPUT:

```
FPUT "DAGGER [SWORD KNIFE BAG
STONE JEWEL] returns the list [DAG-
GER SWORD KNIFE BAG STONE
JEWEL].
```

Let's continue with the example of an adventurer's inventory. At the start of a game he would have nothing: MAKE "INVENTORY []. As he finds objects, he may choose to pick them up and keep them. Let's define a word GET, so that he can give commands such as GET "SWORD. Here's our first attempt:

```
TO GET :OBJECT
  MAKE "INVENTORY FPUT :OBJECT
  :INVENTORY
END
```

The trouble with this definition is that it does not check to see if the object is actually present in the room for the adventurer to pick up. One way to deal with this is to have a variable, let's call it CONTENTS, which contains a list of all the objects in the room. To find out whether an object is present we would

then need to see if it was in the list CONTENTS, so what we really need is a procedure that checks whether an object is in a list. Most versions of Logo include a primitive, MEMBER? (or MEMBERP), that does just this, but it is instructive to see how it could be defined:

```
TO MEMBER? :OBJ :LIST
  IF EMPTY? :LIST THEN OUTPUT
  "FALSE
  IF :OBJ = FIRST :LIST THEN OUTPUT
  "TRUE
  OUTPUT MEMBER? :OBJ BUTFIRST
  :LIST
END
```

This procedure works down the list, checking each element in turn until it either finds a match or comes to the end of the list. It returns either the TRUE or FALSE value which can be used as the input to an IF, in Pascal terms MEMBER? is a Boolean function. We can now test whether an object is present:

```
TO PRESENT? :OBJECT
  IF MEMBER? :OBJECT :CONTENTS
  THEN OUTPUT "TRUE ELSE OUT-
```

```
PUT "FALSE
END
With PRESENT? we can write an
improved version of GET:
TO GET :OBJECT
  TEST PRESENT? :OBJECT
  IF TRUE MAKE "INVENTORY FPUT
  :OBJECT :INVENTORY
  IF FALSE PRINT [I CAN NOT SEE]
  PRINT :OBJECT
END
```

So much for picking up objects, but if our adventurer wishes to get rid of some of his possessions and put them down, we'll need a word PUT; he can therefore say PUT "SWORD.

```
TO PUT :OBJECT
  TEST MEMBER? :OBJECT :INVEN-
  TORY
  IF TRUE MAKE "INVENTORY DELETE
  :OBJECT :INVENTORY
  IF FALSE PRINT [YOU DON'T HAVE
  IT!]
END
```

That's a nice, simple definition, the only trouble being there is no primitive called DELETE. Here's how we might define DELETE in order to remove an element from a list:

```
TO DELETE :ITEM :LIST
  IF EMPTY? :LIST THEN OUTPUT []
  IF :ITEM = FIRST :LIST THEN OUT-
  PUT BUTFIRST :LIST
  OUTPUT FPUT FIRST :LIST (DELETE
  :ITEM BUTFIRST :LIST)
END
```

It is worth looking closely at this procedure for while it is short it is powerful, and illustrates a number of basic principles about writing list processing procedures. Notice that it is an operation: it outputs the value of the list without the given element. The three steps of the procedure translate into English as follows:

- 1) If the input list is empty it is not possible to remove anything, so output the empty list.
- 2) If the first element of the list is the object we are trying to remove, output the rest of the list without that first element.
- 3) Otherwise, output a list made by putting the first element at the front of the list you would get by removing the element to be deleted from the rest of the list.

The procedure works because step three is slightly easier than the original problem — the input list is one element less.

Lists of lists

So far we have kept our inventory as a simple list of words, but it might be useful in some games to have a more complex data structure.

If the game allocated a score according to the items in the adventurer's possession, then INVENTORY could consist of a list of lists, each sub-list consisting of the object's name together with its value. For example: MAKE "INVENTORY [[SWORD 20] [KNIFE 10] [BAG 5] [STONE 2] [JEWEL 100]]

TEACH YOURSELF LOGO

It is useful to define procedures which pick out the individual parts of the list. These procedures don't do anything very important, they simply enable us to write slightly more meaningful higher-level procedures:

```
TO NAME :ITEM
  OUTPUT FIRST :ITEM
END
```

```
TO VALUE :ITEM
  OUTPUT FIRST BUTFIRST :ITEM
END
```

So NAME [STONE 2] returns STONE and VALUE [STONE 2] returns 2.

In order to print out the inventory using INV, PRINTVERT would now need to be rewritten as:

```
TO PRINTVERT :LIST
  IF EMPTY? :LIST THEN STOP
  PRINT NAME FIRST :LIST
  PRINTVERT BUTFIRST :LIST
END
```

Assuming that our game only awards points for possessions, SCORE will print out the adventurer's score:

```
TO SCORE
  PRINT SCORE 1 0 :INVENTORY
END
```

```
TO SCORE 1 :SUM :LIST
  IF EMPTY? :LIST THEN OUTPUT
  :SUM
  OUTPUT SCORE 1 ( :SUM + VALUE
  FIRST :LIST ) BUTFIRST :LIST
END
```

In this procedure, notice the way in which the value of the sum is built up. It is passed on at each recursive call, and eventually returned as the value of the operation.

Describing the room

We've discussed the adventurer's possessions, but the rooms could also be represented as lists. Here's a possible room:

Name: room2.

Description: this is a dark room about 20 feet square; exits: north to room 5 and south to room 8.

Contents: sword, bottle.

One way to represent this information is to define a variable ROOM2: MAKE "ROOM2 [[THIS IS A DARK ROOM ABOUT 20 FEET SQUARE] [[N ROOM5] [S ROOM8]] [SWORD BOTTLE]].

We could then do the same thing for each of the other rooms in the game. In order to keep track of where the adventurer is, we need a global variable HERE that contains the name of the room the adventurer is in at the time. We might begin with MAKE "HERE "ROOM2.

Having represented the data as lists, we now need to write some words to extract the various parts of the data, particularly the description, the contents and the exits. It is more convenient for some of these procedures to work

from the end of the list rather than from the beginning. Logo provides three primitives, LAST, BUTLAST and LPUT, which correspond to FIRST, BUTFIRST and FPUT, differing only in that they work from the end of the list rather than from the beginning.

DESCRIPTION "ROOM2 outputs the description of the room.

```
TO DESCRIPTION :ROOM
  OUTPUT FIRST THING :ROOM
END
```

CONTENTS "ROOM2 outputs the list of contents of the room

```
TO CONTENTS :ROOM
  OUTPUT LAST THING :ROOM
END
```

EXITS "ROOM2 outputs a list of directions in which you can go from that room.

```
TO EXITS :ROOM
  OUTPUT GETEXITS [] FIRSTBUT-
  FIRST THING :ROOM
END
```

```
TO GETEXITS :EXITS :EXITS LIST
  IF EMPTY? :EXIT LIST THEN OUTPUT
  :EXITS
```

```
  OUTPUT GETEXITS (FPUT :OBJECT
  CONTENTS :HERE) (BUTLAST
  THING HERE)
END
```

GETEXITS takes the list from the room details, for example [[N ROOM5] [S ROOM8]], assigns it to EXITLIST and builds up a list of the possible exits in EXITS which it finally outputs — here [NS].

We can put these three together into a word LOOK which prints out what we can see at the time.

```
TO LOOK
  PRINT DESCRIPTION :HERE
  PRINT [YOU CAN SEE]
  PRINT CONTENTS :HERE
  PRINT [YOU CAN GO]
  PRINT EXITS :HERE
```

END

These procedures could be used in other parts of the game: for example, EXITS might be used to check on valid moves. The command to move north will be MOVE "N, where MOVE is defined as follows:

```
s MOVE "N.
TO MOVE :DIR
  TEST (MEMBER? :DIR EXITS :HERE)
  IF TRUE MOVE IT :DIR
  IF FALSE PRINT [YOU CAN'T GO
  THAT WAY]
```

END

MOVE simply checks that the move is valid; if it is, then it passes the work over to MOVEIT. Write MOVEIT yourselves — it must go down the exit list in the room description, find out which room lies in the moved direction, and then set the value of HERE to the new room name.

As a final example, consider the problem of altering a room description: for example, updating the room's contents if an object is PUT down. PUT would have to include a call to ADD:

```
TO ADD :OBJECT
  MAKE :HERE LPUT (FPUT :OBJECT
  CONTENTS :HERE) (BUTLAST
  THING HERE)
END
```

END

To understand how this works, let's assume that the value of HERE is ROOM2; MAKE :HERE then becomes MAKE "ROOM2. The value to be assigned to ROOM2 is what we get by putting FPUT :OBJECT CONTENTS :HERE in place of the last item in the list. What is FPUT :OBJECT CONTENTS :HERE? It is a list made up by putting the new object at the front of the old contents list for ROOM2, which is precisely what we wanted.

This is part three of a six-part series. **END**

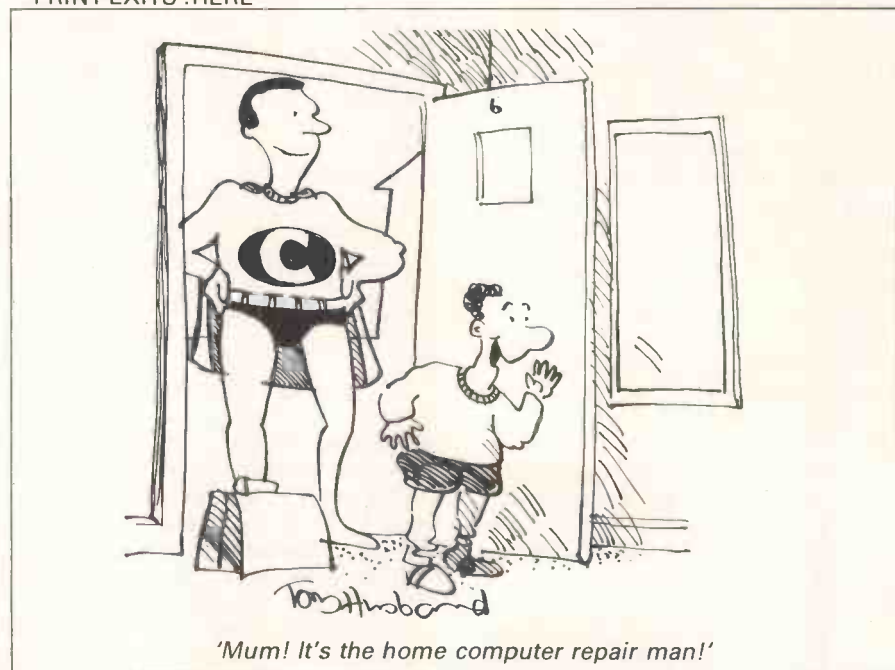

Introducing the new and improved IBM PC. From £49.50*.

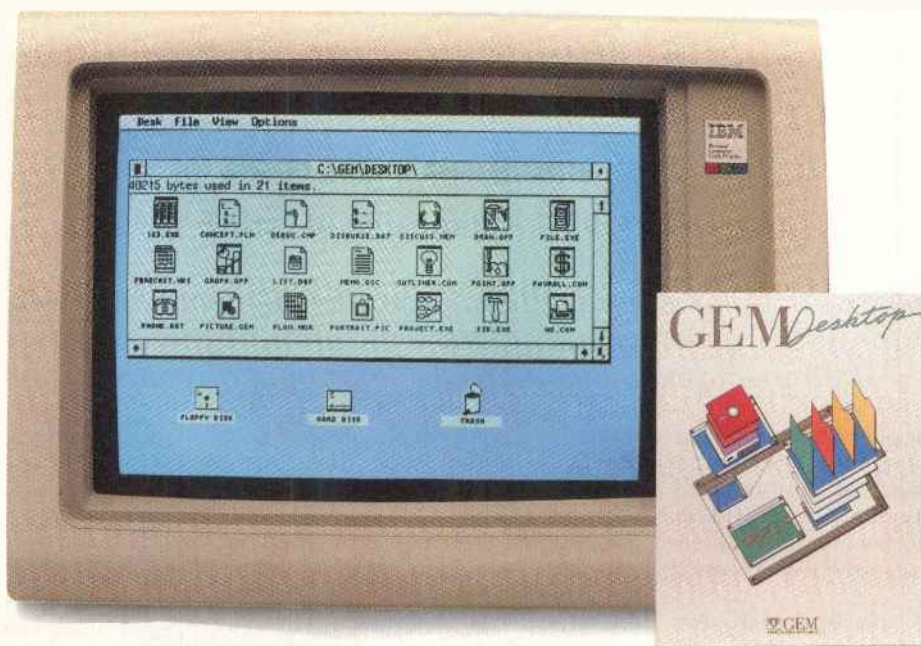

Actually, it's not a new IBM® PC, it's GEM Desktop™. The £49.50 software breakthrough that makes your old IBM PC so astonishingly easy to use that it seems like a new one.

The perfect partner for PC DOS

Slide GEM Desktop into your IBM's disk drive and the change begins. From this moment on you can run all of the important PC programs – but instead of the tiresome typing of cryptic commands you simply point and click your mouse or your cursor keys to open a window.

It's like a breath of fresh air compared with the complex PC DOS operating system commands.

Instead of typing and retyping long file names, you simply point and click at the appropriate symbols. Files are opened, copied, moved and discarded at the touch of a button. Your IBM PC is easier and faster to use than ever before. Helpful menus appear and disappear as you need them. And a clock and calculator are built in for your convenience.

Indispensable at only £49.50

GEM Desktop comes with amazingly simple instructions. In fact, for the first time GEM Desktop software makes it possible for anyone to learn to use an IBM PC.

Phone or send your order now for one complete package for only £49.50 (plus postage, packing and VAT*) and soon you'll be wanting one for every IBM PC you have.

While you're on the line, ask us about GEM Draw™, our nifty £129.95† graphics package, which includes GEM Desktop, with an extensive gallery of art.

Even buying GEM Desktop is easy.

1. Just call (0635) 35354 and quote your credit card number.
- Or 2. Post the order form with payment.
- Or 3. Contact your local IBM PC dealer.



	Price	P & P + VAT	Unit Cost	Qty	Total
*GEM Desktop	£49.50	£10.45	£59.95	_____	£ _____
GEM Draw (incl. Desktop)	£129.95	£22.37	£152.32	_____	£ _____
I enclose cheque/postal order for £ _____					
Name _____					
Company _____					
Address _____					
_____ Post Code _____					

†Special introductory price. Offer closes 30.9.85. PCW2

Post to: GEM Software, Digital Research (UK) Limited, Oxford House, Oxford St., Newbury, Berks RG13 1JB. (Please allow 14 days for delivery.)



GEM requires that your computer has appropriate graphics and that the pointing device be compatible. Call for exact requirements. GEM, GEM DESKTOP and GEM DRAW are trademarks of Digital Research Inc. IBM is a registered trademark of International Business Machines Corporation. Digital Research is a registered trademark of Digital Research Inc. © 1985, Digital Research Inc. All rights reserved.





SCREENTEST

Dataflex

Equinox's Dataflex, a powerful database management system, is excellent for system developers but rather difficult for inexperienced users.

Kathy Lang examines the package for signs of reconciliation.

Most software suppliers, faced with the task of implementing their packages on a wide range of systems, simply avoid the problem altogether by providing single-user versions only, or put their packages onto just one or two hardware systems.

In contrast to this approach, the supplier of the database management system Dataflex, an American company called Data Access, has long made a point of providing its product on as wide a range of micros as possible, including a wide variety of systems which can be shared among several users. As a result it has achieved widespread popularity among system developers, and is increasingly being bought by computing services in large companies for use by a variety of users in client departments. It was a request from one such user, directed to me by PCW, which finally decided me to look in detail at a package which has long been a candidate for this series, but which I feared might be just too complex to interest less experienced users. Dataflex's power and flexibility are undoubted, but how easy would it be for those without previous computing experience to use it for simple applications? Here I'll concentrate on this aspect of the package, while adding just a flavour of the power Dataflex can provide for experienced users and system developers.

Dataflex stores its information in fixed length records; each record in a file has the same structure. Files may be related to one another through key fields, with the relationships being specified when the file is set up. The Dataflex philosophy is based upon what it calls 'configurations', which are basically sets of commands prepared for use on particular sets of files. To be used, configurations must be compiled, in contrast to most command-

driven packages which interpret commands once for each time that a sequence of commands is executed. From a user's point of view, this means that the first time a task is carried out, two operations are required (rather than the one needed in most such packages). This is because, after you have set up a sequence of commands, you must first compile the source code and then execute it. When this has been done, you may re-execute the same sequence without recompiling.

In this respect Dataflex has much in common with program generators, which must go through a translation phase before being executed. Unlike most program generators, the output of this translation phase is always a compiled program, which may be faster to execute than a comparable set of interpreted commands. (From the Benchmarks, it would appear that for operations within Dataflex, the package is indeed relatively fast.) So you have a trade-off between taking a little longer to set up the commands needed to run a task, and the time taken to carry it out.

Dataflex provides two major aids to making this process reasonably easy for novices, and reducing to a minimum the dangers of rigidity in the two-stage approach. Firstly, a set of programs and utilities is provided to enable you to carry out the main data management tasks which most people require — setting up files, adding and amending records, displaying and printing simple reports. With this basic set of features, you can use Dataflex as a simple data management system without going near the individual commands of Dataflex itself. These utilities can be accessed from the menus supplied with Dataflex, so that a reasonable degree of power is available just through the use of menus. Better still, most of these programs and utilities actually create

Maximum file size	2 gigabytes
Max record size (ch)	ML(min 16000)
Max no fields	255
Max field size	255
Max digits	18
Max prime key length	NS
Special disk format?	N
File size fixed?	Y
Link to ASCII files?	YV
Data types	N,C,D
Fixed rec structure?	Y
Fixed record length stored?	Y
Amend rec structure?	CO
Link data files?	Y
No data files open	20(min)
No sort fields	9+
No keys	9
Max key length (chars, fields)	NS,6
Subsidiary indexes kept up-to-date?	UTD
Data validation	G
Screen formatting	P,C
Unique keys	AM
Report formatting	P,D,C
Store calculated data	IN,ED,BA
Totals & statistics	Y
Store selectn criteria	P
Combining criteria >1 criterion/field?	A,O,N
Wild code selection?	Y
Browsing methods	SW
Interaction methods	AK
Reference Manual+	M,C,FT
Tutorial Guide+	***
Reference Card+	N
Online Help+	****
Hot-line?	**
	P

For a full explanation of abbreviations, see 'Database dossier', page 188, January issue

Fig 1 Features and constraints (for 16-bit systems)

Dataflex configurations. The advantages of this are two-fold: you get a ready-made set of examples of configurations to supplement those supplied with the system; and you have a basic set of configurations which you can adapt to add extra features, rather than starting from scratch to learn what is really a high-level programming language.

Secondly, there is one menu option which not only helps novices, but also goes a long way to offset the disadvantages of the two-stage approach. The area of application which suffers most from a totally compile/execute approach is *ad hoc* queries. The flexibility of Dataflex is such that it would be possible to write a complete configuration which offers all the options for querying you could think of, with parameters (such as selections to be performed) entered when the configuration is executed. This would take a long time and a lot of expertise, so Dataflex provides such a facility itself, called Query. I'll say more about its facilities under 'Selection & sorting'; for now, suffice it to say that Query is sufficiently flexible to allow you to meet most requirements for one-off lists and reports. In addition, due to Query being an executable program, it can be given the options needed and executed immediately, rather than setting up the query commands, compiling and then executing them. Another consequence of this approach is that Query can be used even with the Dataflex run-time system, to generate *ad hoc* reports within the framework of a tailored system.

For more experienced users, the two great advantages of Dataflex are its flexibility in providing the equivalent of a high-level language with special facilities for handling databases, and its multi-user features. The latter are provided in such a way that each user of a shared database can be provided with an accurate picture of the data which their actions will update, but the sequence of operations can be arranged so that records are locked for the minimum period of time necessary to protect data integrity. A further boon is that, unlike some of its competitors, Dataflex is not copy protected. For those who sell the results of their labours, the availability of a run-time system will be an additional recommendation.

Constraints

The main limitations are shown in Fig 1. The figures shown are the minimum which may be available on 16-bit systems; the restrictions may be greater for 8-bit systems, and less on 16-bit systems with more than the minimum amount of memory. For example, the maximum record size in 8-bit systems is at least 4000 characters, while the maximum record size in 16-bit systems is at least 16,000 characters. In 16-bit systems, the constraints are unlikely to

impose any serious limitations on record processing.

Date fields may be American or European format, as determined when the system is installed. Validation features which come with the system include checking ranges or specified values, and forcing entry of a field.

File creation and indexing

The process of preparing a file to be used in a Dataflex configuration includes defining its format and the indexes to be used to access it, specifying the maximum number of records it is to hold (although this can be changed subsequently), and, where appropriate, creating a screen form to use when entering and updating records. The simplest approach to this process is to use the Dataflex program AUTODEF, which uses a series of menus and questions to lead you through the whole process. The file definition can most easily be accomplished by creating a screen 'image' which can subsequently be used for data entry, and which contains titles, captions and field labels as required, plus indicators of the field positions and lengths. This involves typing underscores to show where the fields will be — three underscores indicate a three-character field, four underscores followed by a decimal point indicate a five-digit integer, and so on. This screen image may be prepared either with a word processor (such as WordStar in non-document mode) or with Dataflex's own simple editor, which gives paint-a-screen features using cursor and function keys.

When the screen image has been set up, you can then run AUTODEF. You will be asked to give the name for each field (Dataflex cannot pick this up from the captions used, even where they are to be the same), and to specify the index fields. Index keys may consist of up to six fields (four on 8-bit systems); all indexes must be unique, but can be made so by attaching the record number as the last field in a key, a procedure which would, in practice, for fields with duplicate values, reduce the number of data fields in a key by one. A file may have up to nine indexes (four

on 8-bit systems) in addition to the record number; these are kept up-to-date as data is entered and amended.

In addition, you may have a single *ad hoc* index, which is created as it is needed and need not be specified at this point so that it can be used to order the file in further ways for reports. Where two or more files are to be linked together, the relationships are based on indexes whose fields must be identical in type and size in the related files.

When indexes have been specified, you cannot change the specification without re-indexing either on the one key which has been changed, or on the whole set; this process is reasonably fast (see Fig 2 for Benchmark times). To change the format of the record without writing a Dataflex program involves copying the data file twice; you use Query to create a plain text version of the file, then use a Dataflex utility, FILEDEF, to amend the record format, and finally use another Dataflex utility, READ, to create a configuration to re-import the data into the new format. FILEDEF provides an alternative route for setting up and amending the formats of data files and indexes, which gives more control over the process than the automated route via AUTODEF.

Data input and updating

If you use the AUTODEF program to set up your files, it will automatically create the necessary program to allow you to enter and amend records. This allows you to add new records, to amend records retrieved by any key, and to delete records. The Enter supplied macro provides a more sophisticated approach to the same requirement, giving you the ability to have programs set up which carry out command processing within the data entry phase (for example, to supply calculated fields), and which include data from more than one file on a single screen image. You cannot, though, use ENTER to specify that several records be displayed for amendment on a single screen. For this kind of option you must set up a configuration yourself, or amend one created initially with ENTER.

BM1	Time to add one new record	3secs
BM2	Time to select record by primary key	Inst
BM3	Time to select record by secondary key	Inst
BM4	Time to access 20 records from 1000 sequentially on three-character field (same field as in BM2 key)	56secs+
BM5	Time to access record using wild code	22secs+
BM6	Time to index 1000 records on three-character field	50secs
BM7	Time to sort 1000 records on five-character field	NA
BM8	Time to calculate on one field per record and store result in record	1min 43secs
BM9	Time to total three fields over 1000 records	1min 35secs
BM10	Time to add one new field to each of 1000 records	35mins 28secs
	Time to import a file of 1000 records:	20mins 55secs
	Notes: NT=Not tested NP=Not Possible +=including scrolling	
	Where two times are given, first is access to first record, second is access to each subsequent record	
	Fig 2 Benchmark times recorded on an IBM PC/XT/hard	



SCREENTEST

Often in a more complex system you will want to automatically carry out certain updating operations—perhaps to summarise and archive records at the end of a month or year. This kind of 'batch' updating can be carried out by writing your own configuration, using Dataflex commands.

Screen display

The screen images which can be created for data entry and amendment have already been described. When records are retrieved in this way, you can scroll through them in order by the current index (that used to retrieve the record), using keys which request 'next' or 'previous' record. For reporting, you can use the Query facility which displays one record per line, and which allows you to determine the fields to be displayed but does not give you any control over formats. Output from the Report macro can be directed to the screen. You can use Dataflex's extensive repertoire of display commands to provide precise control over screen displays. These commands include the ability to show complete lines, and to place particular data at specified points on the screen using direct cursor control.

Printed reports

Simple printed reports can be produced using the Query facility, which permits output to the screen, a printer, or a file.

More sophisticated formatting is provided by the Report macro, which allows you to specify a report with header and sub-header, body, sub-total and total sections. Nine levels of sub-totals are available, as well as overall totals. Formatting is achieved by including an image of the format the report is to take, linked to commands which dictate what is actually printed.

Reports created in this way may include information from more than one file. Where the Report macro does not provide sufficient flexibility, you can use direct output commands which provide similar facilities to those outlined under 'Screen display'.

Selection & sorting

The Query facility allows you to select on a maximum of 10 criteria. If you want to select records which match one of several values on a single field, each test counts as a selection, but they are, of course ORed: that is, the record is selected if any one such test is passed. Selections on separate fields are

ANDed: that is, only records which pass them all are met. You could therefore issue a selection which requested all those whose postcode shows that they live in Birmingham or London, and have blue eyes and fair hair.

When using the Report macro, you can request that tests be ANDed or ORed, or that records pass if a test is *not* true. All these tests can use the conventional range of comparison operators (less than, greater than, and so on) plus a 'containing' test for character fields. If these facilities are insufficient, there is a range of commands to carry out tests, including an IF...ELSE group.

No sorting facilities are provided; Dataflex allows you to order data using indexes. Most of these will be specified when the file is first defined, and if the specification is changed then the file must be re-indexed. A single temporary index is provided which can be set up on an *ad hoc* basis for particular reports; this saves having to alter the file definition simply to have a report printed in a particular order. It also saves the extra processing and space overheads of additional indexes.

Calculation

Dataflex provides three commands which aid calculation: MOVE (which allocates values to variables and fields); INCREMENT (which adds one to the value of a field or variable); and CALCULATE (which allows you to enter a simple arithmetic statement to carry out calculations on field or memory variables). Any variables (as distinct from fields in stored records) must be explicitly defined in the Dataflex program.

Multiple files

Many of the Dataflex facilities relating to multiple files have already been mentioned, including the ability to explicitly relate files by defining the key fields which dictate the correspondence between records. For example, if you are programming an accounting system, the invoice file might have links to the customer file by customer account code, and to the stock file by stock item code.

This method is more constricting than that used by many packages which construct relationships between files on an *ad hoc* basis, but equally this approach should make the development of more complex systems quicker and simpler.

At most points in the system, you can refer to fields from several related files. In configurations, fields are referred to by the convention 'filename.fieldname,' rather than by providing a dictionary to all fields and requiring uniqueness of field names within a single database.

Package	Cost (£)	Summary
Dataflex	695	Powerful, flexible database management system available on a wide range of single-user and networked systems. Excellent for system developers, good for novices prepared to apply themselves. Clumsy manual, excellent reference summary and examples.
dBaselll	495	More advanced version of popular dBasell package. Allows maximum 10 files open at once, which can be interrelated as you wish on a DIY basis. Flexible indexing. Command-based: can store sets of commands to get close to programming. Only on IBM PC and clones.
KnowledgeMan	545	Powerful data management system, few software limits on processing. Spreadsheet included, word processing and business graphics as add-ons, all loosely integrated. Features for experienced users and system developers excellent, rather complex for novices.
Sensible Solution	565	Powerful multi-user, multi-file system based on central data dictionary which holds all record definitions. Menu-driven for beginners but no default formats, so lots of work to do to get started. Tailoring powerful but tedious to implement.
Sycero	595	Powerful and flexible program generator, with good facilities for screen handling and processing, powerful command language, ability to incorporate Basic statements if desired. Rather complex for novices, better for software developers.

Fig 3 Comparison of similar data management packages

Tailoring

The full range of Dataflex commands allows you to program systems of a complexity comparable with those you can build in high-level languages such as Basic or Cobol. In fact, Dataflex is written in Pascal, and the approach of its command language is reminiscent of the flavour of Pascal itself (though without, I'm glad to say, the use of the dreaded semi-colon as statement separator). Space does not permit a full description of the facilities available, but they include some straightforward features for setting up simple control systems including menus for end users.

Quite sophisticated systems can be built from the basic building blocks which Dataflex provides, including the Enter and Report macros and the menu-building features, without the need to learn about Dataflex commands. Nevertheless, these commands do give system developers considerable power and flexibility to build configurations for other users. For example, Dataflex includes the ability to define your own commands, which can be executed with parameters, and to assign sets of commands to function keys through user-defined procedures. A surprising omission is the absence of any security features such as password protection for data files.

In view of its undoubted power and flexibility, the length of time it has been on the market, and its availability on a wide variety of machines, it is interesting — and surprising — that up to now Dataflex has not, in contrast to the market leaders, generated an extensive cottage industry of run-time system applications. I would expect to see this change quite rapidly. It may reflect the initial strategy of the UK distributor, Equinox, which was to market Dataflex alongside a range of other products. Dataflex distribution is now handled by an offshoot of Equinox called by the name of the product. There is already a users' group.

Housekeeping

Dataflex allows you to delete, rename and copy files within the package, to access the directory listing, and to run

operating system commands with return of control to the current menu.

Links with outside

You can read and write ASCII text files using Dataflex utilities (Read and Query respectively). The text files may use commas or carriage returns to delimit fields. For more complex formats Dataflex provides commands to read and write sequential text files, so you could construct virtually any format you need with a configuration of your own. Unlike the Dataflex facilities using internal file formats, the commands to handle sequential files are not particularly fast in operation.

User image

At the simplest level, Dataflex can be used as a menu-driven system for setting up simple files, and handling the entry and reporting of data. Most people, however, would not be willing to pay so high a price for a system which they could otherwise obtain for less than £200. To get value for money you really need to go beyond the basic features, and use at least the supplied macros for entry and reporting, plus the utilities for changing record definitions, setting up menus, and so on. I was able to run all the Benchmarks save two with this approach, and I found the system quite easy to use. For example, to import the Benchmark file I used the Read utility, which sets up an appropriate configuration to import a text file into a predefined database file. This process rarely works first time, but on this occasion it did.

Beyond these supplied programs and utilities, you need to use the range of Dataflex commands, and may need to go on to use procedures and to reset the function keys. I found programming with Dataflex quite straightforward, and both the programs to run Benchmarks compiled and ran correctly first time. As with setting up screen images, I found it best to use my word processor to construct program source files and then re-invoke Dataflex — the package allows you to compile files from other directories, so that is relatively problem-free.

Dataflex would be even easier to use

if, instead of key stickers to display the standard uses of the function keys — to carry out operations such as Find a record, Save a record or Query a definition — the package were provided with a template. You cannot make use of more than one set of stickers, so anyone who uses more than one package which does not have a template is stuck!

Documentation

The Dataflex documentation is both an aid and a hindrance to understanding. The package comes with a manual, a reference summary and a set of example configurations. I suspect that most experienced users would do better to use the reference summary (which is one of the best I've seen and includes a complete syntax definition of all commands), together with the example configurations, and largely ignore the manual. This is a curious mixture of the tutorial level and the terse reference style, and explains the Dataflex features in a very curious order. It is more useful if used purely for reference, using the reference summary as a kind of index (there is an index to the manual, but I didn't find it very helpful). This is perfectly feasible, as the reference summary has a feature I've often recommended but (I think) never before seen, and that's a reference to the page in the manual for every command.

Conclusion

Dataflex is a powerful and flexible system, available on a very wide range of both single and multi-user micros. It provides extensive facilities for relatively inexperienced users, as well as advanced tools for system developers. It is about as easy to use as a system of this power can be, but as you would expect, people with little experience will get the most out of the system only by undertaking a couple of days' formal training.

That said, I feel that on balance, Dataflex represents one of the best chances for users with enthusiasm and a little experience to get worthwhile results from a powerful database management system. For them and for experienced users, the breadth of function, combined with the availability of a run-time system which includes the relatively powerful Query facility, and the absence of copy protection, must make Dataflex well worth considering.

For some people, the constraints imposed by the need to compile source code before executing sets of commands will be a drawback, but it should be set against the potential improvements in performance which may be achievable with a compiled system. Where this last is a consideration, you should make sure you carry out some timing tests for yourselves. My Benchmarks suggest that Dataflex is considerably faster than most, but not all, of its competitors. 

Summary

Supplier	Equinox/Dataflex Systems
Telephone	(01) 729 4460
Cost	£695
Systems	80,86,MS,PC,MU
Version reviewed	2.1
Type	S,E
Features	Powerful multi-user, multi-file database management system. Full tailoring facilities for system developers. Maximum of nine indexes per file on 16-bit systems, kept up-to-date. Flexible screen display and reporting.
Drawbacks	All command sets must be compiled before use, so two-stage operation for everything except simple queries.
Ease of use	Quite good for experienced users (apart from need to compile). Macros and menus for novices, but still complex.



BIBLIOFILE

Happy hacking is the theme as David Taylor logs on to making money, plus all about Ada in this month's book selection.

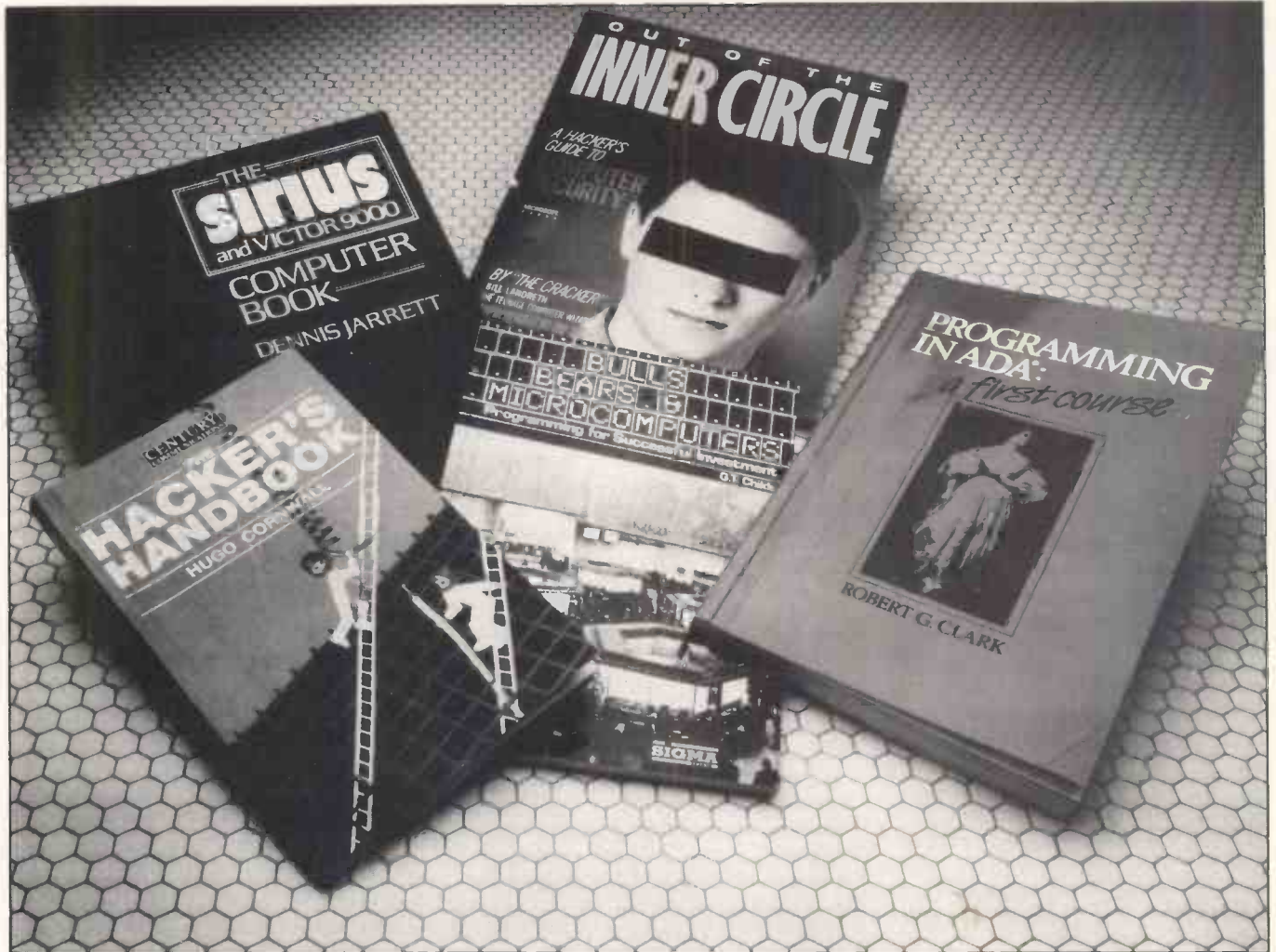

Cloak and hacker

Title: The Hacker's Handbook
Author: Hugo Cornwall
Publisher: Century Communications
Price: £4.95 (paperback)

You've read the news, now read the book. It is wicked to hack; not very wicked, hacker Hugo protests, but a little bit wicked just the same. The FBI takes a very dim view. Blokes with suspicious-looking bulges under their armpits might come knocking at your door. Your ZX could be seized in the middle of the night.

It's all very well, provided we take hacking to mean only you and your modem messing about on more or less legitimate lines — a database here, a bulletin board there. That's an innocent educational sport, the way Hugo sees it.

If now and again you're not, so to speak, welcome to look around — well, there's probably no harm done.

But logging on unscrupulously — where to hack is to poke your nose into other people's computerised business without their knowledge or permission — that's definitely wicked. It's usually tricky and long-winded, probably illegal and, of course, it sounds like tremendous fun.

Computerniks have been at it for years: relishing the tease of locating some remote system, defeating its protection and having a quick, unauthorised rummage. No-one knows how many succeed. Hackers would naturally like everyone to believe that they're surreptitiously re-programming the mainframe at Fort Knox or breaking into the Kremlin's electronic mailbox most evenings. Victims, on the other hand, are equally anxious to allay fears

that their files could ever have been tampered with. Vested interests make the actual extent of hackers' mischief pretty hard to assess.

Public opinion tends to be in exaggerated awe of hackers. We're easily bemused by sensational reports of computerised crime or by such Hollywood hokum as *Wargames*, in which a schoolkid dials into the Pentagon and nearly starts World War III.

Reality is more prosaic. With a few spectacular exceptions, like 'The Great Prince Philip Prestel Hack', it is, as a rule, pretty dull. The satisfaction, so all hackers insist, is in the ingenuity (and persistence) needed just to fathom a good connection.

This book offers general guidelines and looks at methodology from some entertaining examples of hacks by pseudonymous Hugo himself (he's a professional computer security consul-

tant). It describes the first principles of developing hacker's intuition, and reveals that 95 per cent of successful hacks rely on simple password acquisition. It explodes the myth that virtuosity at the keyboard is all, and urges you to scour by the hour for random clues and disconnected information — everywhere from specialised publications to exhibitions and obscure libraries, even dustbins. Hugo cheekily demonstrates how such gleanings can be used, for example to build up a shrewd idea of what systems MI5 uses.

It's a lively if often superficial account, but despite Hugo's protestations that *anything* is still possible — that men will always boldly hack where no men have hacked before — the conclusion seems to be that the best days are now over. As the targets get smarter, hacking isn't what it used to be.

Cracking nuts

Title: *Out of The Inner Circle — A Hacker's Guide To Computer Security*

Author: Bill Landreth

Publisher: Microsoft/Penguin

(paperback)

Price: £8.95

It's certainly all over now for Bill Landreth — The Cracker — who was one of America's most notorious teenage computer wizards until he was 'apprehended by the FBI', and indicted by a Federal Grand Jury.

Gee whiz, you guys, he was only having fun. He didn't mean no harm. He was just a kid. They were all teenage kids in California's 'Inner Circle' of computer freaks. All they seem to have done was to hack about in GTE Teletel's system.

Still, the FBI wasn't taking any chances — these kids could be Comies! Even the judge insisted Landreth be looked over by a psychiatrist before sentence was passed.

Now The Cracker is a reflective old-timer of 19. This is his life story and his summary of a reformed insider's advice to those who'd rather not become victims of insidious hacking.

It's stirring stuff . . . 'It's Sunday night and I'm in my room, deep into a hack. My eyes are on the monitor and my hands are on the keyboard, but my mind is really on the operating system of a super-minicomputer a thousand miles away — a super-mini with an operating system that does a good job of tracking users and that will show my activities in its user logs, unless I can outwit it in the few hours before the Monday-morning staff arrives for work.' It sure beats homework.

The Cracker then identifies five kinds of (American) hackers, from *novices* star-struck by *Wargames* (who are a nuisance), through *students* (who find hacking a whole lot more intellectually stimulating than school), *tourists* (who

seem to come to hacking much as they might come to an occasional crossword), *crashers* (who are trouble-makers out to cause havoc for kicks) and the out-and-out computer *thief*.

This book isn't so much stirring as rather depressing. It implies that hooligan hacking is reaching epidemic proportions in the US, and plays on paranoid fears that your precious data files will be next unless you're extra vigilant. I dare say there's some truth in it. The risk is that people can easily become obsessively cautious, living in fear of the sinister, suspecting constant conspiracy, becoming convinced that evil-doers are all out there and trying to get them. That, if you like, is the dark side of happy hacking and it does not make for an edifying read.

The money program

Title: *Bulls, Bears & Microcomputers — Programming for Successful Investment*

Author: GT Childs

Publisher: Sigma Press

Price: £6.95 (paperback)

There may be readers of this book, the author admits, who have bought it in the hope of becoming suddenly rich. Almost all readers will have had this in mind, I'd imagine.

The book is written in an unfortunate, patronising style which labours to imply that most micro users are stumped for things to do after they've tired of zap-kapow games. So why not take up small-scale investment as a hobby and run a few Basic programs to keep track of your market performance?

Why not, indeed, if your motive is merely to have a bit of fun and gain a better understanding of financial jargon, although it isn't half stretching it to suggest that *'The Financial Times* will hold no more mysteries' or that 'you'll soon be on equal terms with the professionals'.

Throughout this book I was reminded of Horace Batchelor who, when I was at school, used to hard-sell Radio Luxembourg listeners his infallible method for cleaning up on the horses. I wonder now what I used to wonder then: if it's all so simple, how come *everyone* isn't as rich as Croesus?

First Ada

Title: *Programming in Ada*

Author: Robert G Clark

Publisher: Cambridge University Press

Price: £22.50 (hardback), £8.95

(paperback)

There are two sides to this business. On the one hand Ada is exciting, state-of-the-art stuff: tomorrow's all-purpose programming language — vast, fast, flexible and reliable. On the other hand,

Ada was devised by the US Department of Defence and its primary purpose is to program military hardware. It is a fair bet that much of President Reagan's 'Star Wars' anti-missile defence program will rely heavily on Ada, and the MoD also sees Ada as a likely successor to Coral.

The author takes a sanguine, academic view. Ada, he maintains, is better suited than Pascal (from which it derived) or Fortran for teaching university students the fundamental concepts of computerised problem-solving. Ada is named after the redoubtable Countess of Lovelace, Byron's daughter and assistant to Charles Babbage, whose 19th century 'analytical engines' are generally taken to have been the precursors of 20th century computers. The implication must be that today's Ada is a language which encourages thoughtful programming.

This is a textbook which provides a fascinating and lucid insight which, it is acknowledged, only dips one toe into the ocean of Ada's ultimate capacity. Yet it is pretty esoteric stuff and scarcely likely to grip the average home micro user. It isn't as if you can flick through the small-ads of *PCW* and find yourself tripping over Ada compilers!

Highly recommended for students, but it's likely to fox almost anyone else.

No, but Siriously

Title: *The Sirius and Victor 9000 Computer Book*

Author: Dennis Jarrett

Publisher: Hutchinson

Price: £17.95 (paperback)

Technically superlative, commercially a nightmare: Victor's Sirius was ahead of IBM's PC in bringing the joys of 16-bit (Intel 8088) processing to the desk-top, but was haplessly out-dazzled by the Big Blue limelight. The Sirius also established ACT as a hardware distributor, but after a series of financial vicissitudes and protracted manufacturing wrangles, the Apricot emerged a hotter property. So who needs a handbook on a micro which is apparently over the hill?

About 60,000 users do, reckons the author, whose own deep affection for the beast is clear, even if he has previously written a similar tome on the PC.

What readers get here is a comprehensive and beautifully presented guide to the hardware itself and to the jobs it can accomplish as well as, if not better than, many more fashionable rivals.

The book is a model of its kind: well-structured, well-written and well laid out — promoting all of the Sirius's many strengths and acknowledging its few shortcomings. It will, of course, be of absorbing interest to Sirius users and ought to persuade many others that, even in the age of the Macintosh, the Sirius is still a good buy.

END

SCREENPLAY

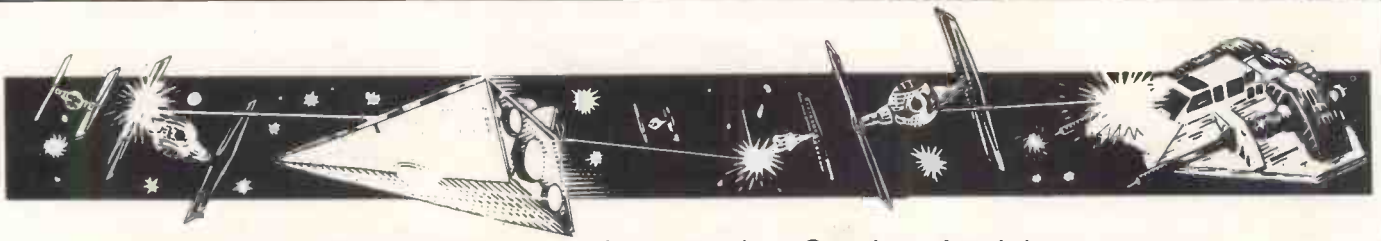

From bouncing bombs to nuclear attack — Stephen Applebaum goes to war, joins MI5 and tiptoes down to the fairy dell in this month's selection of the best games for the Commodore 64, Spectrum and Apple Macintosh.



Bouncing bombs

Title: Dambusters
Computer: Commodore 64
Supplier: US Gold
Format: Cassette, disk
Price: £9.95, £14.95

US Gold's long-running love affair with the theme of war is still going strong, and by the looks of it, the UK release of Dambusters will keep the relationship blossoming.

If the title of the game rings bells, it is because it's based on the now legendary bombing raid on the German Moehne, Eder and Sorpe dams by Scampton-based 617 squadron during World War II. One of the most intriguing aspects of the operation was the bouncing bomb, designed by Barnes Wallis, and the precise manner in which it had to be dropped if each of the dams was to be breached successfully. Not only did this mean flying at very low level under the cover of night, but also at precise speeds and distances from the dam. All these points, and more, have been incorporated into US Gold's depiction of operation Chastise, as the mission was inappropriately code-named.

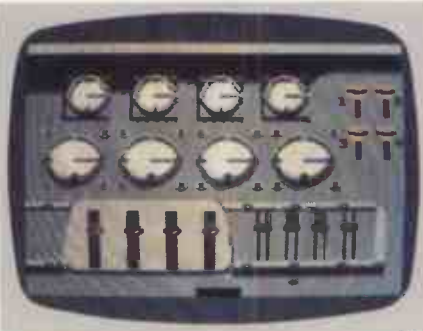

Dambusters the game is primarily a flight simulator, but thanks to some neat interweaving of arcade action and mind-bending strategy, the company has created a program which will keep you on the edge of your seat for hours.

The game begins with a view through the cockpit of a Lancaster bomber onto the runway at RAF Scampton. Seven men make up the aircraft's crew, but unfortunately you seem to be the only one who has turned up for duty. Not only do you have to fly the plane, but act as navigator, front gunner, rear gunner, first and second engineers, and bomb aimer too.

Each crew member's position is represented by a different screen, individually accessed by pressing a specific numeric key on the top row of the 64's keyboard. Three of these screens are used during take-off: one sets the aircraft's trim, another contains the engine throttles and boosters, while the third, the cockpit, gives your speed, height and forward view.

Once airborne, and believe me that's a feat in itself, you fly across the English Channel to the French coast. A map screen allows your heading to be set, as well as giving vital information on enemy ground positions.



Nothing much happens until you reach French airspace. Searchlights suddenly pierce the darkness, and unless they're shot out with a swift bit of cannon fire, you become easy pickings for the highly manoeuvrable ME110 night fighters of the German Luftwaffe.

If you survive the night fighters, avoid the barrage balloons, dodge the flak, shoot out the searchlights and extinguish any engine fires that might have started during the flight, you can attempt a run at one of the dams.

While approaching the dam and setting your bomb spinning in its cradle dangled beneath the Lancaster's belly, several screens must be toggled between to check on your height and distance from the target. When everything is in order, a press of the fire button sends the bomb bouncing over the water's surface.

In the disk-based version of Dambusters, the bomb is actually shown in profile approaching the dam. After a fixed time interval the screen goes blank, and you are left with a nailbiting wait to see if your efforts have been a success. Tape users will not have this option, although they will have the excellent screen where the dam is smashed and water gushes out.



Fairy frolics

Title: Elidon
Computer: Commodore 64 (Amstrad, Spectrum and MSX versions planned)
Supplier: Orpheus
Format: Cassette
Price: £8.95

If you thought being a fairy was all fun and dancing round the flowers at the

bottom of the garden, Elidon will make you think again. In a world which turns Cicely Mary Barker's poem, *Where*, on its head, every day becomes a struggle for survival. Butterflies become butchers, and even the seemingly harmless flowers hold little solace for a flight-weary fairy.

The Elidon of the title is a secret forest which is just emerging from the icy clutches of winter. The fairy queen rules over the forest, and is in need of a crown which must be a garland made from the seven flowers of Finvarra. Unfortunately the garland cannot be made until the flowers bloom, and that means exposing them to seven magical potions

hidden throughout the forest. It is your task to find the mystical cordials, give your queen a crown, and win the privilege of sitting at her side.

In play, Elidon is very reminiscent of Sabre Wulf. The graphics are extremely pleasing to the eye, depicting various parts of the forest with its different flowers, pulsating butterflies, and other less recognisable creatures. Rather more disappointing is the fairy that you guide around the forest. Orpheus extols the virtues of her animation, but apart from the wings, she seems to be suffering from acute, and very early *rigor mortis*.

Moving around this strange world

can be very painful indeed. Until you know what is and what isn't safe to touch, you find yourself constantly being sapped of fairy dust—the elixir of life.

To complete the game, you have to work out what effects the various objects lying around the different screens have. Only three can be carried at a time, but there are far more dotted about Elidon.

Elidon is a nice and quite original diversion from the usual search-and-pick-up type of game. Both the graphics and sound are good, and make up a program which should have a lot of appeal in the younger age bracket.



Chips with everything

Title: Chipwits

Computer: Apple Macintosh

Supplier: Brainworks Inc US

Format: Disk

Price: \$49.95

According to the manual, 'Chipwits teaches... general problem-solving methods, both intuitive (right-brain) and logical (left-brain)'. Well, how can you expect to get on if your left brain doesn't know what your right brain is

doing?

In spite of what the manual says, Chipwits is actually fun to use.

The basic ingredients are a little bespectacled robot called a Chipwit and eight different 'environments' that it has to negotiate. Each different environment consists of a number of rooms holding assorted good things and bad things. At the most basic level, the idea is to eat the good things and zap the bad. At higher levels, you have to negotiate a maze or pick up an object surrounded by exploding bombs.

In order to successfully negotiate the different environments, you need to develop individual programs to drive the little Chipwit. This is where the package is really clever—you build up the program by dragging little chips around the screen and combining them to form the program. Each chip has an arrow pointing out of it which you can set to point to the next chip.

The basic Chipwit programming options allow you to Look, Feel and Smell the room for objects and move the

Chipwit forwards, backwards, left or right. When the Chipwit has found something, it can either eat it or zap it. The graphics for eating are especially good—a little arm extends from the robot, grabs the object and brings it back for the robot to chomp on.

If you select the zap option, a little laser gun appears on the Chipwit's head and it vaporises whatever is in front of it.

Using these basic tools, you can make up an extremely dumb Chipwit which just blunders around aimlessly and eats or zaps everything it comes across.

When you get more adventurous, you can play around with pushing and poking data on and off stacks, and building much more intelligence into your Chipwit. You can have it rushing through the rooms remembering where it's been, and differentiating between good things and bad.

As an educational program, Chipwits is very good. Not only does it teach the fundamentals of programming, it is fun to use.



Tinker, tailor... mole

Title: The Fourth Protocol

Computer: Commodore 64, Spectrum 48k (used for screenshots)

Supplier: Hutchinson Computer Publishing

Format: Cassette, disk

Price: £12.95 (Spectrum and Commodore 64 cassette), £15.95 (disk)

Games based on books or films often tend to be smash-and-grab affairs, with little more than the most tenuous of threads linking the software to the original material. The Fourth Protocol,



based on Frederick Forsyth's book of the same name, by no means falls into this trap, thanks to the programmer's eye for detail and obvious respect for the author's work.

Forsyth's explosive plot centres around the last few weeks leading up to a general election. Political advisors in the Kremlin want the Labour Party returned to power because they believe it could be duped into withdrawing Britain from NATO, so creating an opening for a Russian invasion and, ultimately, a Soviet take-over of mainland Europe. To try to ensure Labour's re-election, Moscow prepares plan Au-

rora—a scheme to explode a small nuclear bomb, following it up with a condemnation of the US whom it will blame for the atrocity. This, it is hoped, will coax people into voting for Labour, the only party advocating unilateral disarmament.

Hutchinson Computer Publishing's game is quite true to the book. There are three parts to the program, the first two of which are purely icon-driven, while the third is an arcade phase requiring both the nimble use of a joystick and some very fast typing.

Program one begins with you being appointed head of CI(A) (the MI5 section responsible for security of government buildings) and on the trail of a mole within the organisation. Positioned around the screen are several large icons, each of which provides a facility for either storing, retrieving or finding new information. Placing a cursor over any of the icons produces a menu from which a function can be selected.

One of the most often-accessed icons is a large telephone. This allows you to call up various computers, and talk to

SCREENPLAY

other characters dotted throughout the government and the CIA).

At the top of the screen is a video camera. This represents your surveillance team, or 'watchers', as they are called. A number of these super-snoopers can be sent out to keep watch and report back information on the person's whereabouts, personal life, and so on. Details acquired in this way can be filed for later reading.

Information gained from watchers and various other sources should lead you to the name of the traitor, and who he or she is working for. Unless you solve the puzzle within a 40-day (1 hour 20 minutes) time span, you cannot progress to the second challenge. A save option means that you don't need

to complete the game in one sitting.

Game two is much the same as the first, except this time you are out of the office and wandering around the streets of London trying to locate the bomb. There are many locations to explore, so rather than hoofing round the capital, you can catch a bus, take a taxi, or sample the delights of the Underground.

Apart from getting run over by a London bus, there are many other obstacles that will impede you in your search. These range from the odd terrorist to the great British rail strike. Should you last long enough, you'll hopefully stumble across the password giving you access to part three.

Having found the bomb, it must be

defused. In the Commodore 64 version, the screen depicts a room containing a filing cabinet in which the device is stored. As you try to open it, KGB agents rush in and must be dealt with before you are overpowered, leaving the bomb to go off.

The final part of the Spectrum version is quite different, featuring a shoot-out between agents from both sides. Not until all the KGB stooges have been killed can the cabinet be tackled and the bomb defused.

The Fourth Protocol is an excellent game — not only in its story line and execution but also its graphics, all of which go to make it a must for adventure enthusiasts who like a game with substance.



Sport for all

Title: International Basketball
Computer: Commodore 64
Supplier: Commodore
Format: Cassette
Price: £5.99

It has been a long time coming, but International Basketball has finally arrived and deserves to be as successful as its predecessor, International Football.

Purists and close *aficionados* of the

sport might be offended by the amount of licence that has been exercised where International Basketball's accuracy is concerned, but this mainly amounts to scaling down a team's size from five to three players, and has little effect on the overall game — if anything, it makes it easier.

Before attempting to play an opponent, it is a good idea to get in some practice against the computer. There are nine different levels of proficiency, so there's plenty of opportunity to perfect your passing and shooting skills. You should be able to beat the computer every time at level one, although I found it almost impossible to even get the ball when playing it at the highest level.

Another factor affecting the difficulty of play is the rules. Three different sets are available from the NBA and the NCAA, up to the more imposing international rules.

In play, International Basketball is much the same as International Football in that only one man can be

controlled at a time. The character under control changes from moment to moment, depending on which of the three is nearest to the ball at any one time. When he has the ball, a player can jump, dribble and throw the ball. How hard you throw it depends on the duration of time you hold the fire button down. A short press equals a short pass and *vice versa*.

International Basketball is graphically superior to International Football, and just has the edge on sound quality. The bouncing of the ball, for instance, sounds impressively realistic, while the clapping of the spectators is suitably enthusiastic.

It's not often that a game based on a sport manages to create the atmosphere of the real thing, but International Basketball goes past the stage of being a non-effective, two-dimensional representation to the point where the player almost feels that he is actually down there on the court. This is a marvellous game and one for everyone, not just sport addicts.



Anyone for tennis?

Title: On-Court Tennis
Computer: Commodore 64
Supplier: Activision
Format: Cassette
Price: £10.99

Tennis is a popular game for home micros. Usually I'm not very good at it because I either run to get the ball too

early, too late, or not at all. On-Court Tennis, therefore, should have cured my ineptitude as the computer moves both players. However, once it had guided me to the ball, I messed everything up by swinging the racquet at totally the wrong moment. This was not necessarily due to my bad timing, but rather because there are so many different strokes at your fingertips.

The game has been programmed so that the joystick can simulate five different shots. Moving the joystick forwards produces a flat shot — backwards, a lob — sideways right, a topspin shot — sideways left, a slice, and by pressing the fire button you can throw in a drop shot.

Confused? You will be when you play it. If that isn't enough, there are also five different modes of serve. Oh, for the days of Pong!

On-Court Tennis contains some very nice features, not least of which is the

option each player is given to choose one of four top seeds. Each of the four has different playing characteristics, giving them all a margin of error on a specific stroke, an unpredictable temperament, or low endurance.

The game also has a series of different playing surfaces (grass, hard court and clay), plus what the manual terms a 'floating intelligence'. This means that during a man-versus-machine game, the computer can vary its skill level as you become increasingly more competent. As soon as you think you can win, the computer has a flash of inspiration and pummels you into the ground.

On-Court Tennis is certainly one of the better sport programs for the Commodore 64. Its graphics and sound are good, while the action is thick and fast. It's just a pity that Activision doesn't provide the strawberries and cream as well!

END

The Ferranti lowdown on IBM compatibles.

£3000



£2700

£2400

£2150

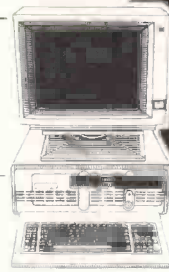

FERRANTI
PC 860 XT

£1700

£1250



FERRANTI
PC 860

Until now you had to pay over the odds for an IBM compatible personal computer.

Not any more. Now you have a choice.

At £1250* the Ferranti PC860 is 25% cheaper than the nearest competing IBM compatible.

Which is definitely incompatible with what the PC860 offers - as standard...

* 12 months on-site maintenance FREE, with 8-hour response.

* PERFECT⁺ II applications software, including filer, spreadsheet and word processor.

* 256kb RAM expandable to an outstanding 640kb, to cope with today's bigger programs and masses of user data.

* New IBM compatible keyboard.

* Inbuilt colour graphics, Centronics interface, 3 IBM compatible expansion

slots and 2 full 16 bit slots.

* 8086 processor with true 16 bit working for fast operation, yet with supreme compatibility.

* New slimline package - only 166mm high.

And now for just £900* more, the PC860 XT, gives you all this plus an extra 10mb of database capability.

Whether you're a dealer or a customer, get the lowdown on the Ferranti PC860 and PC860 XT now, by posting the coupon.

Ferranti Computer Systems Limited,
Derker Street, Oldham, Lancs. OL1 3XF.
Telephone: 061-624 9552.
Telex: 665764.

FERRANTI

Personal computers

Ferranti PC 860 IBM compatible. Price incredible.

Please give me the name and address of my nearest Ferranti PC dealer.
Please send me the facts on the Ferranti PC860 and PC860 XT.

Name _____

Position _____

Company _____

Address _____

Tel _____

Post to:
Ferranti Computer Systems Limited,
Derker Street, Oldham, OL1 3XF. PCW/8/85

*Excluding monitor and VAT.

+ PERFECT is the registered trade mark of Perfect Software Inc.

TJ'S WORKSHOP



Our monthly selection of hardware and software tips for the popular micros. If you have a favourite tip to pass on, send it to TJ's Workshop, PCW, 32-34 Broadwick Street, London W1A 2HG. Please keep your contributions concise and enclose a stamped addressed envelope if you want them returned. We will pay £5-£30 for any tips we publish. PCW can accept no responsibility for damage caused by using these tips, and readers should note that any hardware modifications may render the maker's guarantee invalid.

FAST BBC DISK FORMATTER

Although BBC disk operation is already quite fast, this routine increases it by up to 40 per cent. When disks are formatted by the Watford or Acorn disk filing systems, the sectors on all tracks are placed in the order 7, 8, 9, 0, 1, 2, 3, 4, 5, 6. This means that when the disk drive steps from one track to another, it misses the first sector of the next track because the head needs time to settle and so has to wait for the disk to make another revolution. The disk therefore needs to revolve twice in order to read or write one track.

This routine formats the disk so that sectors are placed in a different order and gives the

head time to settle down. The first track has the sectors organised as 7, 8, 9, 0, 1, 2, 3, 4, 5, 6; the second, two further back: 5, 6, 7, 8, 9, 0, 1, 2, 3, 4, and so on. The routine was written for the Watford DFS and Shugart drives, and some experimentation may be needed for other set-ups by altering the separate variable in line 170. I suggest trying a step rate of 3 or 4, which should speed up disk operations by about 30 per cent.

To use the program, format all your new disks with it as usual. After this, all the normal disk operations will operate more quickly.

Note that the Acorn DFS cannot have 62 files, only 31. Do not just format your old disks if you want to speed them up as this will erase them. Copy the files from the old disk onto a newly formatted one.

Morten Tolboel

```

10 REM *****
20 REM ***** Disk-formatter program by Morten Tolboel 1985 *****
30 REM *****
40 REM
50 REPEAT
60 INPUT "Which drive " ; driv ;
70 UNTIL drive%>0 AND drive%<=3
80 REPEAT
90 INPUT "31 or 62 files " ; files ;
100 UNTIL files%<=31 OR files%<=62
110 REPEAT
120 INPUT "40 or 80 tracks " ; nooftracks% ;
130 UNTIL nooftracks%>40 OR nooftracks%<=80
140 PRINT "Confirms formatting of drive " ; STR$(drive%) ; " : "
150 PRINT STR$(nooftracks%) ; " tracks, " ; STR$(files%) ; " files"
160 IF INSTR("yy",GET%)>0 THEN END
170 SO=7:osword%=$FFF1:steprate%<=2
180 DIM datablock% 1024
190 REM *****
200 REM ***** Formatting procedure *****
210 REM *****
220 FOR TX=0 TO nooftracks%-1
230 TS=STR$(TX):IF LEN(TS)=1 THEN TS="0"+TS
240 PRINT TS ; " ; "
250 FOR SX=0 TO 9
260 ?(datablock%+SX*4)=TX
270 ?(datablock%+SX*4+1)=0
280 ?(datablock%+SX*4+2)=(SO+SX) MOD 10
290 ?(datablock%+SX*4+3)=1
300 NEXT
310 ?%70=drive%!*%71=datablock%!*%75=5
320 ?%76=%65!*%77=TX!*%78=21
330 ?%79=%2A!*%7A=0!*%7B=16
340 ?%7C=0
350 XX=%70:YZ=0!*AX=%7F
360 CALL osword%
370 IF %7C>0 THEN VDU7:PRINT "Error track " ; STR$(%7C) ; END
380 SO=SO-steprate%:IF SO<0 THEN SO=SO+10
390 NEXT
400 PRINT
410 REM *****
420 REM ***** Setup data for catalogue *****
430 REM *****
440 FOR AX=0 TO 1023
450 ?(AX+datablock%)=0
460 NEXT
470 IF nooftracks%<=80 THEN !:(datablock%+262)=%2003!:(datablock%+774)=%2001
480 IF nooftracks%<=40 THEN !:(datablock%+262)=%9001!:(datablock%+774)=%8001
490 FOR AX=512 TO 519
500 ?(datablock%+AX)=%AA
510 NEXT
520 REM *****
530 REM ***** Step to track 0 *****
540 REM *****
550 ?%70=drive%!*%71=datablock%!*%75=1
560 ?%76=%69!*%77=0!*%78=0
570 XX=%70:YZ=0!*AX=%7F
580 CALL osword%
590 IF %7B>0 THEN VDU7:PRINT "Error " ; END
600 REM *****
610 REM ***** Write 2 or 4 sectors depending on number of files *****
620 REM *****
630 ?%70=drive%!*%71=datablock%!*%75=3

```

```

640 ?%76=%4B!*%77=0!*%78=0
650 IF files%<=31 THEN ?%79=%22 ELSE ?%79=%24
660 ?%7A=0
670 CALL osword%
680 IF %7A>0 THEN VDU7:PRINT "Error " ; END
690 PRINT "Formatted"
700 END

```

QL MICRODRIVE BACK-UP

Making back-up copies of microdrive cartridges for the QL can be quite a problem. With a large number of files, all the old copies on the back-up cartridge have to be deleted and new versions copied

across individually.

This routine does the job automatically by reading both directories, and establishing which are new files and which are existing ones to be replaced. It then performs all the required DELETE and COPY commands. The routine works from a working copy in MDV2__ to a backup copy in MDV1__.

Martin Ridgway

```

90 REMark
100 REMark *****
110 REMark = MICRODRIVE BACKUP =
120 REMark =
130 REMark = by MARTIN RIDGWAY =
140 REMark *****
150 REMark ALLOW A MAX OF 30 FILES
160 DIM file%$(30,20)
170 DIM file2%$(30,20)
190 REMark STORE THE DIRECTORIES INTO SEPARATE FILES
220 OPEN NEW £3,mdv1_dir1
230 DIR £3,mdv1_
240 CLOSE £3
250 OPEN NEW £3,mdv1_dir2
260 DIR £3,mdv2_
270 CLOSE £3
330 REMark INITIALISE VARIABLES FOR PROCESSING OF DIRECTORIES
350 LET current% = ""
360 LET direct% = 1:filecount% = 1:headline% = 0
390 OPEN IN £3,mdv1_dir1
400 READFILES
410 CLOSE £3
420 DELETE mdv1_dir1
440 LET filecount% = filecount% - 1
445 REMark *****
446 OPEN IN £3,mdv1_dir2
450 LET direct% = 2:filecount% = 1:headline% = 0
460 READFILES
490 LET filecount% = filecount% - 1
500 CLOSE £3
510 DELETE mdv1_dir2
520 REMark NOW COMPARE THE TWO LISTS OF FILE NAMES
540 FOR current2 = 1 TO filecount2%
550 LET match = 0
560 FOR current1 = 1 TO filecount1%
570 IF file$(current1) = file2$(current2) THEN
580 LET match = 1
590 EXIT current1
600 END IF
610 END FOR current1
620 IF match = 1 THEN
630 PRINT "Replacing " ;
640 DELETE "mdv1_" & file2$(current2)
650 ELSE
660 PRINT "Copying " ;
670 END IF
680 COPY "mdv2_" & file2$(current2) TO "mdv1_" & file2$(current2)
690 PRINT file2$(current2)
700 END FOR current2
710 STOP
720 REMark *****
730 DEFine PROCEDURE READFILES
740 REPEAT readloop
750 IF EOF(£3) THEN EXIT readloop
760 LET as = INKEY$(£5)
770 REMark TEST IF THE FIRST TWO HEADER LINES HAVE BEEN PASSED
800 IF headline% = 2 THEN
810 IF CODE(as) = 10 THEN
820 ADDNAME
830 ELSE
850 LET current% = current% & as
860 END IF
870 ELSE
890 IF CODE(as) = 10 THEN
900 LET headline% = headline% + 1
910 END IF
920 END IF
930 END REPEAT readloop
940 END DEFine READFILES
950 REMark *****
960 DEFine PROCEDURE ADDNAME

```



```

980 IF direct% = 1 THEN
990   LET file%(filecount%) = current%
1000 ELSE
1010   LET file2%(filecount%) = current%
1020 END IF
1030 LET filecount% = filecount% + 1
1040 LET current% = ""
1050 END DEFine ADDNAME

```

ORIC POKES AND CALLS

Many machine code programmers want access to the graphics routines in ROM. The routines and their start and data addresses are listed in Fig 1.

Use of the command CURSET 120,100,1 will result in values being stored in locations #2E1 to #2E6 as

follows:
#2E1:120
#2E2:0
#2E3:100
#2E4:0
#2E5:1
#2E6:0

To use the routines in your machine, store values in the appropriate locations as above and then call the ROM routine.

The POKES and CALLS are also very useful for my programs.

Trevor Latham

Command	Start address	Data addresses
CURSET	#EBDF	#2E1 to #2E5
CURMOV	#EBE2	#2E1 to #2E5
DRAW	#EBE5	#2E1 to #2E5
CIRCLE	#EBE8	#2E1 to #2E5
CHAR	#EBEE	#2E1 to #2E5
FILL	#EBFA	#2E1 to #2E5
PAPER	#F17F	#2E1
INK	#F18B	#2E1
PATTERN	#EBEB	#2E1

Fig 1

DOKE 27,#F42D	Resets the machine when a program is broken into
POKE #22B,64	Disables the reset button
POKE 805,N	Changes the repeat speed of the keys, with N as the new speed
POKE 759,32	Puts the Oric into lower case
POKE 759,0	Puts the Oric into upper case
POKE #C3,65	Disables PEEK, DEEK and any other function
CALL #EF4D	Plot pixel at current hi-res cursor position
CALL #EF74	Invert pixel at current hi-res cursor position
CALL #EF94	Erase pixel at current hi-res cursor position
CALL #F72E	Switch caps message on
CALL #F735	Switch caps message off
POKE #2F1,12B	Switch printer on
POKE #2F1,0	Switch printer off
CALL #E70E	Print ROM software designers message
CALL #CC95	Display 'redo from start message' and continue with program
CALL #CDCF	Display 'extra ignored' message
CALL #FAFA	Produce key click
CALL #FB10	Produce return click
CALL #F64A	Toggle caps on/off
CALL #F8BB	Soft reset

HARNESSING THE 6845

Have you ever wondered how many of the advanced video tricks in the games for your BBC are produced? The answer lies in the 6845 CRTC chip which processes everything that is passed

to the screen.

This routine allows the user to intercept the commands to the 6845 and change them—this can have many interesting effects. The chip's 13 registers are directly POKEd to at the addresses &FE00 and &FE01. Lines 50-60 in the routine initialise the registers, and line 80 lists their function. You then enter three values: the register number, start, and final values

to place in it. Tapping a key will increase the value by one, from the initial to the final. Fig 1 contains some sample values

that show what the chip can do. There are, of course, many other effects to be found.
Andrew Smith

Register number	Initial	Final	Function
13	1	1000	Smooth pixel scrolling
00	1	1000	Tuning effect on TV
01	40	128	Materialising screens
01	128	40	4x magnification
09	6	6	No line gaps
10	1	1	Very fat cursor
07	1	32	Scroll up

Fig 1

```

10 REM Harnessing the 6845
15 REM   Video Chip
30 REM By Andrew.F.G.Smith.
40 MODE 4
50 #TV 255,0
60 #FX12,2
70 PRINT
80 FOR EX=0 TO 13:READ E#:PRINT"№.":EX,E#:NEXT
90 INPUT ""Register to alter":X
100 INPUT ""Start Value":S
110 INPUT ""Final Value":L
120 PRINT""PRESS A KEY...":AS=GET$
130 FOR RX=S TO L
140 REM   Set 1st 6845 byte
150 ?%FE00=X
160 REM   Set 2nd 6845 byte
170 ?%FE01=RX
180 AS=GET$:PRINTTAB(0,0);RX;
190 NEXT
200 #FX12,10
210 DATA Total Cells,Horiz.Chars,Horiz.Sync,Sync Width,Size of Link,Screen Refresh,Vert.Chars,Vert.Sync,Interlacing,Vert.Lines,Cursor size & rate,Cursor Line,High byte for scrolling,Low byte for scrolling

```

ATARI TOUCH-TABLET

I have found a way to use my Atari touch-tablet in my own programs. The touch-tablet uses the paddle locations:

Paddle(0) for horizontal movement; and Paddle(1) for vertical movement. The two buttons are treated as Paddle buttons, Trigger 0 is the same as the left button and Trigger 1 is the right button. The touch-tablet buttons can also be read from Stick(0).

Stick(0)=15	No buttons pressed
Stick(0)=14	Touch-tablet stylus pressed
Stick(0)=11	Left button
Stick(0)=10	Stylus and left button
Stick(0)=7	Right button
Stick(0)=6	Stylus and right button
Stick(0)=3	Both buttons
Stick(0)=2	Stylus and both buttons

John Risby

MEMOTECH GRAPHICS SCREENDUMP

This routine dumps a copy of the Memotech graphics screen to an Epson printer. It produces a double-sized copy of the original which can either be black on white or vice versa.

graphics screen on the Memotech is to use Control-B. This, when sent to the screen, has the same effect as GR\$(x,y,n), and expects three more bytes where x,y are the coordinates of the point to be read and n is the number of bits to be read down.

Before the routine is called, VS4 or a graphics screen must be present or an error will occur.

The easiest way to read the

Chris Amor

MTX TO EPSON SCREEN DUMP

The routine has four modes of operation. The second byte holds the type in this case.
(0) This uses algorithm to match alternate points.
(1) Uses block of four points per screen pixel.
(2) Inverse of type 0.
(3) Inverse of type 1.
written by Chris Amor. July 1984.

```

50 CODE
864B LD A,0 ;TYPE OF PRINT
864D EX AF,AF
864E LD D,191 ;TOP OF DUMP
8650 LD B,0 ;BOT
8652 LD E,0 ;LEFT
8654 LD C,255 ;RIGHT
8656 LD IX,EF75 ;PRORPL (OUTPUT DEVICE)
865A LD HL,E03FC ;ADJUST SIZE OF DUMP
865D LD A,B
865E AND L
865F AND 191
8661 LD B,A
8662 LD A,D
8663 OR H
8664 AND 191
8666 LD D,A

```

```

8667 LD HL, BYTE
866A LD (HL), 0 ;CLEAR FIRST POSITION
866C PUSH BC
866D POP HL
866E LD (IX+0), 1 ;SELECT PRINTER
8672 RST 10
8673 DB 03, 27, "A", B ;SET LINE FEED FOR EPSON
8677 LD B, 0
8678 JR INSTART
867A ROW: DEC B ;SET UP NEXT ROW POINTER
867B DEC B
867C DEC B
867D DEC B
867E INSTART: PUSH BC
867F LD A, L
8680 SUB E
8681 LD B, 0
8683 LD C, A
8684 INC BC
8685 SLA C
8687 RL B
8689 RST 10 ;SELECT EPSON GRAPHICS MODE
868A DB 03, 10, 13, 27, "A", 4, 0 ;FOR (BC) BYTES
8691 POP BC
8692 LD C, E
8693 COL: LD (IX+0), 0 ;SELECT SCREEN
8697 RST 10
8698 DB 02, 27, "C", 0, 0, 0, 4 ;OR*(X, Y, 4) RESULT IN WKAREA
869E LD A, (0FE1A) ;BYTE RETURNED BY GR4
86A1 PUSH BC
86A2 CALL ABYTE ;DOUBLE SIZE
86A5 LD (IX+0), 1 ;SELECT PRINTER
86A7 RST 10
86AA DB 00 ;SEND BC TO PRINTER
86AB POP BC
86AC LD A, C
86AD CP
86AE JR Z, FINISH ;IF LAST COLUMN
86B0 INC C ;NEXT COLUMN
86B1 JR C, COL
86B3 FINISH: LD A, B
86B4 SUB H
86B5 SUB 3
86B7 JR NZ, ROW ;FOR NEXT ROW
86B9 RST 10
86BA DB 06, 10, 13, 27, "A", 10, 13 ;RESET LINE FEED
86C1 LD (IX+0), 0 ;RESET SCREEN
86C5 RET ;TO BASIC ?
86C6 ABYTE: LD C, A ;ENTER WITH BYTE IN A
86C7 PUSH DE ;RESULT RETURNED IN BC
86C8 XOR A ;ROUTINE DOUBLES HEIGHT AND LENGTH OF FLOT
86C9 BIT 0, C
86CB JR Z, NEXT1
86CD OR 3
86CF NEXT1: BIT 1, C
86D1 JR Z, NEXT2
86D3 OR 12
86D5 NEXT2: BIT 2, C
86D7 JR Z, NEXT3
86D9 OR 48
86DB NEXT3: BIT 3, C
86DD JR Z, NEXT4
86DF OR 192
86E1 NEXT4: PUSH HL
86E2 EX AF, AF
86E3 BIT 1, A
86E5 LD H, 0
86E7 JR Z, NOINV ;JUMP FOR BLACK INK
86E9 LD H, 0FF
86EB NOINV: BIT 0, A
86ED JR NZ, TYPE1
86EF TYPE0: EX AF, AF ;MATCHES INTERMEDIATE POINTS
86F0 XOR H ;INVERSE BYTE IF H=0FF
86F1 LD B, A
86F2 LD A, (BYTE) ;ALGORITHM FOR INTERMEDIATE BYTES
86F5 LD E, A
86F6 AND B
86F7 LD D, A
86F8 LD A, E
86F9 SRL A
86FB AND B
86FC OR D
86FD LD D, A
86FE LD A, E
86FF SLA A
8701 AND B
8702 OR D
8703 LD C, A
8704 LD A, B
8705 LD (BYTE), A
8708 POP HL
8709 POP DE
870A RET ;BC HOLDS PAIR OF BYTES
870B TYPE1: EX AF, AF ;NO MATCHING
870C XOR H ;INVERSE IF H=0FF
870D LD B, A
870E LD C, A
870F POP HL
8710 POP DE
8711 RET ;B AND C HOLD SAME BYTE
8712 BYTE: DB 0
8713 RET
8714

```

Symbols:
 BYTE 8712 INSTART 867E
 ROW 867A COL 8693
 ABYTE 86C6 FINISH 86B3
 NEXT1 86CF NEXT2 86D5
 NEXT3 86DB NEXT4 86E1
 NOINV 86EB TYPE1 870B
 TYPE0 86EF TIDYUP 86B9

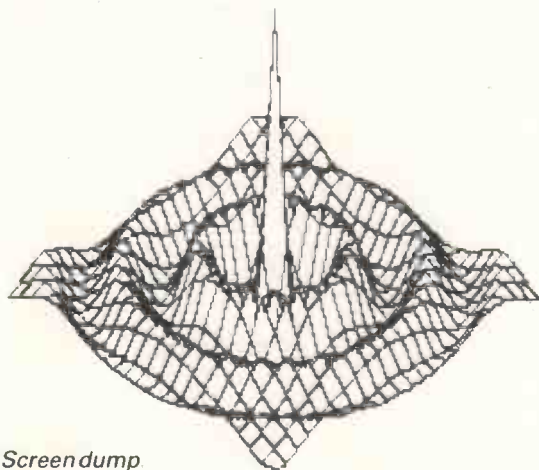

Screen dump

EINSTEIN JOYSTICKS

Finding a lack of joysticks readily available for the Tatung Einstein, I set about discovering what input was required at the analogue ports and if it was possible to modify an existing pair of joysticks to meet this requirement.

The Einstein has two 7-pin DIN sockets as analogue ports on the right-hand side of the computer which are connected to an analogue to digital (A/D) converter. The connections from the socket to the A/D converter are shown in Fig 1. In the Introduction manual, the A/D conversion time is quoted as 40µsecs, and in the Basic manual it quotes the A/D converter as a µPD 7002; this A/D converter has a conversion time of 5msecs. I therefore investigated further and found that the A/D converter fitted, and the one the Introductory manual refers to is the ADC0844.

The main difference between the two is that the µPD 7002 can be configured as either an 8-bit or 10-bit converter under program control. It is also slower than the ADC0844 as previously detailed (although 5msecs is the time taken for 10-bit conversion at a clock frequency of 2MHz).

For use with the joysticks, and differences between the two can be ignored as the system software is designed to handle it. The input to the A/D converter needs to be a voltage swing of two volts, from analogue ground (which you connect to zero volts) and +2 volts (the value of Vref held internally at +2 volts). The computer also requires a switched five volts from the fire button. With reference to Fig 2, you can see how these voltages are achieved and how to connect the joystick to the 7-pin DIN plug.

My joysticks were fitted with 60-degree 100kohm potentiometers, and the values of R1 and R2 in Fig 2 reflect this value. If your joysticks are fitted with different values, then R1 and R2 need to be one and a half times the value of the potentiometers.

I've used the modified joysticks very successfully, and have added the following lines to the PICPEN program supplied with the Einstein (used to draw pictures on the screen) to stop the pen disappearing off the screen, whether using joysticks or the keyboard.

```

2805 IF X>254 THEN X=
254: ELSE IF X<0 THEN X=0
2806 IF Y>191 THEN Y=
191: ELSE IF Y<0 THEN Y=0

```

DSmith

- 1 0volts
- 2 Xchannel
- 3 Firebutton
- 4 Analogue ground
- 5 VReference
- 6 Ychannel
- 7 +5volts

DIN socket



Fig 1

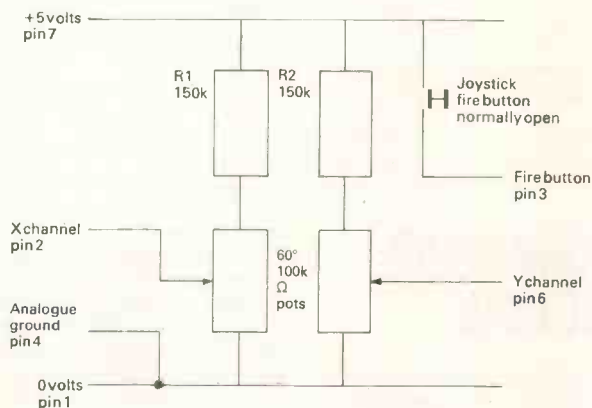

Fig 2 Note: X channel O/P to be 0 volts when joystick to the left, Y channel O/P to be 0 volts when joystick to the bottom

CADO SYSTEM 16.

FOR BUSINESSES WITH MORE AMBITION THAN BUDGET.

When your plans seem to overtake your capital, then Cado System 16 is the computer system for you.

It lets you expand when you can afford to without having to compromise on the equipment you start with.

From its small compact beginnings (it can fit under a desk), System 16 can be expanded up to 16 workstations, multitasking from a comprehensive catalogue of software packages, including: word processing, database, mailing, and a range of specific business software such as Purchase and Nominal Ledger, Stocks, Costing, Sales and Order Processing.

With your future in mind, System 16 gives all software packages access to the main database, with separate password protection for individual databanks should you wish to set up sub-companies.

Response is very fast. System 16's revolutionary design gives you an answer to your enquiry in only a fraction of a second - faster than any

of the competition.

Naturally, Cado System 16 has the advanced CCS Business Systems back up. That means complete systems design, software support, peripherals, technical back up and maintenance, co-ordinated from three regional offices in London, Birmingham and Bristol.

In fact, System 16 is endorsed with everything you'd expect from the \$2 Billion strong Contel-Cado Corporation.

Which should be reassuring, no matter what size your company is now.

Contact your local office for a demonstration or post the coupon now for more information.

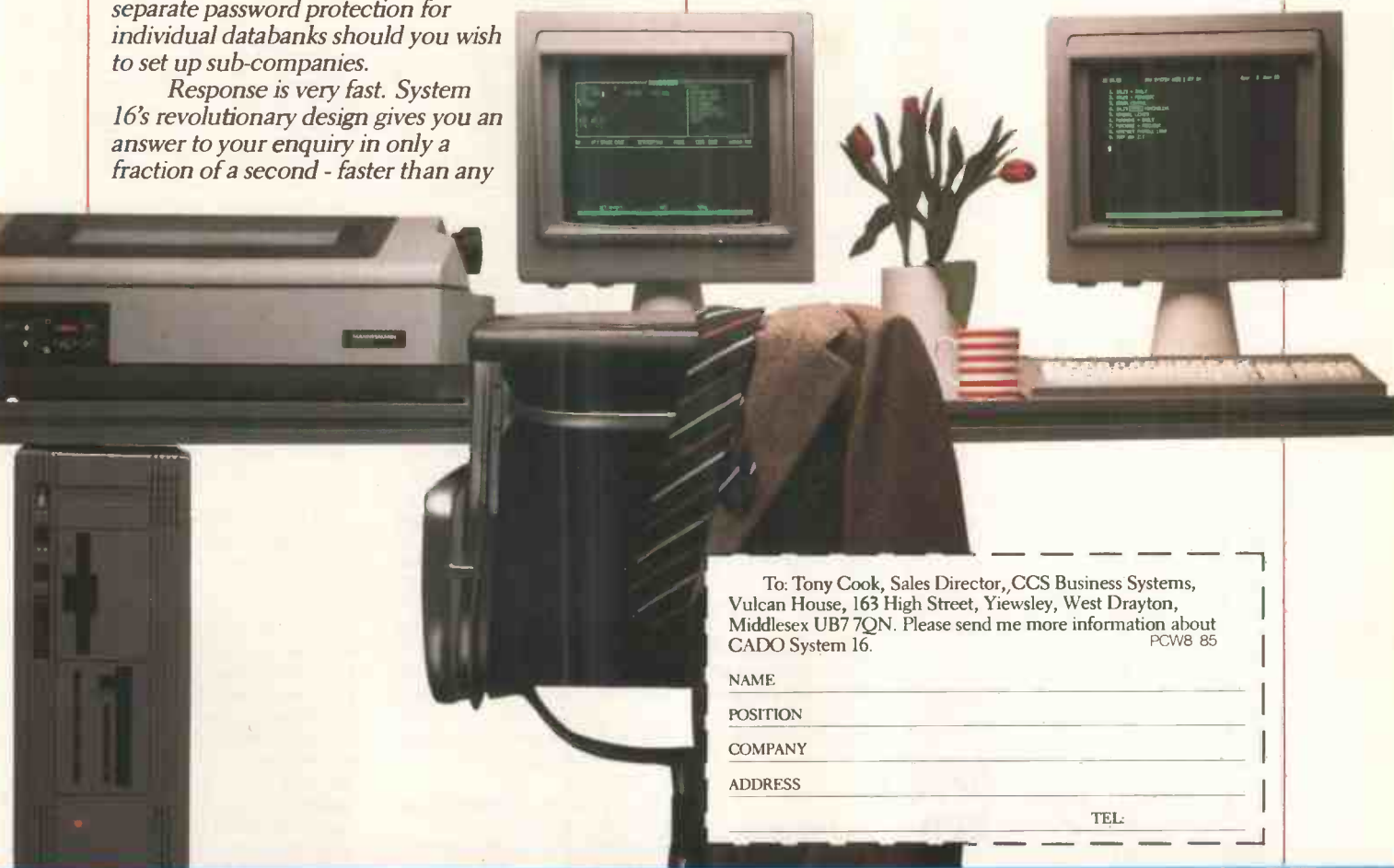

To: Tony Cook, Sales Director, CCS Business Systems,
Vulcan House, 163 High Street, Yiewsley, West Drayton,
Middlesex UB7 7QN. Please send me more information about
CADO System 16. PCWB 85

NAME _____

POSITION _____

COMPANY _____

ADDRESS _____

TEL: _____

CONTEL CADO CCS
BUSINESS SYSTEMS

CCS Business Systems, Vulcan House, 163 High Street, Yiewsley, West Drayton, Middlesex UB7 7QN. Tel: 0895 445757. Telex: 8814207.
BIRMINGHAM, 25-27 Smallbrook, Queensway, Birmingham B5 4HP. Tel: 021-632 5343. Telex: 337619.
BRISTOL, 1 Denmark Avenue, Bristol BS1 5HD. Tel: 0272 290245. Telex: 44363.



David Barrow presents more documented machine code routines and useful information for the assembly language programmer. If you have a good routine, an improvement or conversion of one already printed, or just a helpful programming hint, then send it in and share it with other programmers. Subroutines for any of the popular processors and computers are welcome but please include full documentation. All published code will be paid for. Send your contributions to SubSet, PCW, 32-34 Broadwick Street, London W1A 2HG.

UNTRAPPABLE DIVISION

In *PCW*, November 1984, I issued a challenge for a SubSet Class 1 signed 32-bit division routine for the 68000. The need for this is obvious in the 68000, the 68008 and the 68010, which are limited to 32/16-bit division, with a built-in error trap to catch out those zero divisors.

The 68020, which designs planets in its spare time, does have several forms of full 32-bit division, but it suffers from the (structurally sound) fact that attempts to divide by zero will be trapped and exception processing in Supervisor mode initiated. However, Supervisor mode is unlikely to be available to you, the user, hence the need for a division routine that cannot be trapped.

Terry Browning's DIV32S and DIV32U attempted to solve the problem in *PCW*, April 1985, but got it wrong on a couple of counts. Firstly, his code to set the overflow flag V to show division by zero actually missed its target by a full eight bits — but without causing any havoc. Secondly, there is one possible overflow condition in signed division for which his DIV32S did not test. Terry has, however, sent improvements which correct these mistakes.

Alasdair Macdonald of King's Lynn and AJ Perkins of Bracknell also sent corrected improvements and some very pertinent comments about the 68000 series processors. As no one version solved all the problems of implementing a Class 1 routine on all processors in the 68000 family, code and ideas from all three readers, along with some of my own concepts, are combined in this month's Datasheet, DIV32.

SIGNED OVERFLOW

Quotient overflow can occur in a signed division only if the dividend is the lowest negative value, that is $-2,147,483,648$ ($\$8000\ 0000$ or -2^{31}), and the divisor is -1 . The quotient takes the magnitude of the dividend with a sign change forced by the negative divisor, but the highest positive value expressible in 32 bits using two's complement notation is $2^{31} - 1$. $\$8000\ 0000$ negated is still $\$8000\ 0000$, a negative value.

Terry Browning thinks the output flags for the signed division should distinguish between magnitude overflow and division by zero.

He suggests that the overflow flag V be set to indicate error with the carry flag C set or reset to show which type.

Mr Perkins, however, points out that the C flag is always cleared by the division instructions of the 68000 series, whereas both N (negative, sign) and Z are left in an undefined state if overflow occurs (more on this later).

It seems sensible, therefore, to use N or Z to flag the error type instead of C. DIV32S and DIV32U use the zero flag Z and all three routines clear C.

SPEED AND LENGTH

Alasdair Macdonald notes that the business of stacking the SR is unnecessary in the April versions of DIV32S and DIV32U as the flags can be manipulated by the "MOVE #data, SR" instruction.

This produces quicker, shorter code, and Alasdair's routines at 38 bytes each were indeed the shortest submitted. Terry's improved versions logged in at 86 bytes (signed) and 64 bytes (unsigned), and those of AJ Perkins were 54 bytes and 44 bytes respectively.

which still requires a TST D0 to set exit flags and thus will execute on the 68000 in $12 + 32 * (42-52)$ clocks. The loop in DIV32Z takes $18 + 32 * (44-50)$ clocks — best case timing has been traded for a quicker worst case to produce a more even timing.

```

: ...Main division loop, giving correct quotient.
DIVLP ADD.L D0,D0      :Shift dividend, clear bit 0.  D080
      ADDX.L D1,D1     :shift remainder, get next bit.  D381
      CMP.L  D2,D1     :Will subtraction go?          B282
      BCS  DIVLPT      :Skip if not, leave result = 0,  6504
      ADDQ.B #1,D0     :else set result bit and        5200
      SUB.L  D2,D1     :subtract divisor.             9282
      DIVLPT DBF      D3,DIVLP      :Repeat for 32 dividend bits,  51CB
                                          send with correct quotient.  FFF2
:
    
```

Fig 1

Other ways suggested by Alasdair of speeding up the routines' execution times are to use equivalent but faster instructions. ADD Dn,Dn and ADDX Dn,Dn shift and rotate data registers two or four clocks quicker than ASL #1,Dn and ROXL #1,DN and MOVEQ #0,Dn will clear them two clocks faster than CLR.L Dn. (These figures are for the 68000, 68008 and 68010 — the use of equivalent instructions has a complex effect on 68020 timing.)

Equivalent instructions can build confusion into your programs, and unless speed really is of the essence, clarity is more important. However, the quicker ADDX.L Dn,Dn is used in the main division loop of DIV32Z.

One method of speeding up execution which Alasdair missed is to take as much out of a loop as possible. I have done this in DIV32's division loop, which actually calculates the logical complement of the quotient. The terminating NOT instruction both corrects the result and sets the right exit flags. For comparison, Fig 1 shows Alasdair's main loop

UPWARD COMPATIBILITY

The main bugbear of the April routines for Mr Perkins is the simple fact that neither will run on the 68010 or 68020 in User mode.

As both 68010 and 68020 are designed as virtual machines where both non-existent memory and peripherals may be addressed, the user cannot be allowed access to the system byte of the status register to determine which mode is currently in operation. Consequently, Motorola has made the instruction MOVE SR,<EA> privileged on these two machines. To restore condition code access to the user, it has provided the new instruction MOVE CCR,<EA>, not available on either the 68000 or 68008.

So, in a series of very sophisticated processors, declared to be upwardly compatible, there is no way to program a move of condition codes to either data register or memory that is portable

across all processors in User mode. Any half-decent system software should, of course, deal with the problem and make the resulting illegal instruction or privilege violation processing transparent to the user program.

But system software writers are not noted for their love of low-level programmers, and exception processing could have drastic effects on time-critical user routines.

The best fully-portable method of putting the CCR on stack below a subroutine return address, ready for RTR exit, is awaited.

DIV32 FLAGS

Mr Perkins ventured that any Class 1 division should be portable and should return flag information of the same order as that returned by the 68xxx DIVS and DIVU instructions. This is basically the same reason why Terry Browning originally saved the

Status Register to stack.

Essentially, N and Z should return the sign and zero status of the quotient, V should signal overflow when set, C should be clear and the extend flag X should be totally unaffected.

Overflow can be dealt with by preliminary tests, and N, Z, V and C are correctly set or cleared by a terminal TST of the quotient. X is more difficult as many instructions do affect it, but two methods of preserving it are given in DIV32.

The first, in DIV32S, is to rotate it into the top byte of stack. Restoration to the condition codes is achieved by a sequence of rotations into and out of the quotient, which also flag the quotient's status.

The second method, in DIV32Z, was originally used in Z80 code. By moving the result bits into the quotient one shift in arrears, the carry or extend flag can safely be rotated through the quotient register and back to the C or X bit of the CCR. **END**

DATASHEET 1

```

:= DIV32 32-bit trap-proof division suite.
> DIV32S 32-bit signed trap-proof division.
> DIV32U 32-bit unsigned trap-proof division.
> DIV32Z 32-bit unsigned division with zero divide.

:JOB      DIV32S - To divide one signed (two's complement)
:          32-bit number by another, returning 32-bit signed
:          quotient and remainder, or unchanged operands with
:          division by zero or quotient overflow information.
:          DIV32U - To divide one unsigned (absolute) 32-bit
:          number by another, returning 32-bit unsigned
:          quotient and remainder, or unchanged operands with
:          division by zero information.
:          DIV32Z - To divide one unsigned (absolute) 32-bit
:          number by another, returning 32-bit unsigned
:          quotient and remainder, or "high-values" quotient
:          on division by zero.
:ACTION   DIV32S:-
:          IF divisor = 0;
:          THEN:
:          [ Set division by zero error flags. ]
:          ELSE:
:          [ IF dividend = -2^31 AND divisor = -1;
:          THEN:
:          [ Set quotient overflow error flags. ]
:          ELSE:
:          [ Compute quotient & remainder signs.
:          Compute absolute dividend & divisor.
:          Call absolute value division, DIV32Z.
:          IF quotient sign negative THEN:
:          [ Negate quotient. ]
:          IF remainder sign negative THEN:
:          [ Negate remainder. ]
:          Flag quotient status. ] ]
:          DIV32U:-
:          IF divisor = 0;
:          THEN:
:          [ Set division by zero error flags. ]
:          ELSE:
:          [ Call absolute value division, DIV32Z. ]
:          DIV32Z:-
:          Clear remainder register.
:          FOR 32-bit count;
:          [ Shift last result bit to dividend/quotient,
:          shifting next dividend bit into remainder.
:          Subtract divisor from remainder.
:          IF subtraction went (C = 0);
:          THEN:
:          [ Skip, result = 0. ]
:          ELSE:
:          [ Add divisor to remainder, result = 1. ] ]
:          Shift final result bit into quotient.
:          Complement quotient, flagging quotient status.

:CPU      68000, 68008, 68010, 68020
:HARDWARE None.
:SOFTWARE DIV32Z is a subroutine of both DIV32S and DIV32U.

:INPUT    DIV32S: D0 = 32-bit 2's complement signed dividend,
:          D1 = 32-bit 2's complement signed divisor.
:
:          DIV32U: D0 = 32-bit unsigned (absolute) dividend,
:          DIV32Z: D1 = 32-bit unsigned (absolute) divisor.
:OUTPUT   DIV32S:
:          X unchanged X unchanged X unchanged

```

```

:          N quot. sign N 0 N 0
:          Z quot. state Z 1 Z 0
:          V 0 V 1 V 1
:          C 0 C 0 C 0
:          D0 quotient D0 dividend D0 dividend (-2^31)
:          D1 remainder D1 divisor (0) D1 divisor (-1)
:          DIV32U:
:          X unchanged X unchanged
:          N quot. sign N 0
:          Z quot. state Z 1
:          V 0 V 1
:          C 0 C 0
:          D0 quotient D0 dividend
:          D1 remainder D1 divisor (0)
:          DIV32Z:
:          X unchanged
:          N quot. sign
:          Z quot. state
:          V 0
:          C 0
:          D0 quotient (= $FFFFFFF if divisor was zero.)
:          D1 remainder (= dividend if divisor was zero.)
:ERRORS   None.
:REG USE  A7 (USP), D0, D1, CCR
:STACK USE DIV32S: 14. DIV32U: 12. DIV32Z: 8.
:RAM USE  None.
:LENGTH  128 (DIV32S: 82. DIV32U: 12. DIV32Z: 34).
:CYCLES   Not given.

:CLASS 1 *discreet *interruptable *promable
:***** *reentrant *relocatable *robust

:
:DIV32 :Suite of three trap-proof division routines.
:
:...Signed division returning overflow information.
DIV32S TST.L D1 ;Test for a zero divisor, 4AB1
:ORI #02,CCR ;set V flag without affecting 003C
: ;any other flags and exit 0002
:BEQ D32SX ;Z = 1 if division by zero. 6748
:
:CMPI.L #2^31,D0 ;Test for other possible 0C80
: ;overflow, when dividend is 0000
: ;$80000000 0000
: ;(okay if it isn't) 660C
:BNE D32SOK ;and divisor is $FFFFFFF 0C81
:CMPI.L #-1,D1 ;giving invalid +$80000000 FFFF
: ;quotient. FFFF
:EORI #06,CCR ;Set V always and clear Z 0A3C
: ;only if D1 = -1 then exit 0006
:BNE D32SX ;Z = 0 if overflow error. 6634
:
:D32SOK CLR.W -(A7) ;Clear stack word for flags. 4267
:ROXR (A7) ;Save entry X flag state. E4D7
:
:TST.L D0 ;Test for negative dividend, 4A88
:BPL DRTST ;skip, okay, if positive, 6A04
:NEG.L D0 ;else make absolute and set 4400
:ORI.B #X11,(A7) ;sign flags, quotient (bit 0) 0017
: ;and remainder (bit 1). 0003
:
:DRTST TST.L D1 ;Test for negative divisor, 4AB1
: ;skip, okay, if positive, 6A06
:BPL ABSDIV ;else make absolute and 44B1
:NEG.L D1 ;correct quotient sign flag 0A17
:EORI.B #X01,(A7) ;for changed sign result. 0001
:
:ABSDIV BSR DIV32Z ;Do absolute value division. 6128
:
:BTST #0,(A7) ;Test quotient sign flag 0817
: ;and skip, okay, if result 0000
:BEQ REMSBN ;should be positive, else 6702
:NEG.L D0 ;change to negative. 4480
:
:REMSBN BTST #1,(A7) ;Test remainder sign flag 0817
: ;and skip, okay, if result 0001
:BEQ RESTX ;should be positive, else 6702
:NEG.L D1 ;change to negative. 44B1
:
:RESTX ROXL (A7)+ ;Restore stored X flag and 65D7
:ROXL.L #1,D0 ;rotate in and out of quotient 8398
:ROXR.L #1,D0 ;to flag quotient status but 8298
:ANDI #0FE,CCR ;preserving X, then clear C 023C
: ;leaving X N Z & V unchanged. 00FE
:
:D32SX RTS ;Exit information correct. 4E75
:
:...Unsigned division with division by zero error information.
DIV32U TST.L D1 ;Test for a zero divisor, 4A81
:ORI #02,CCR ;set V flag without affecting 003C
: ;any other flags and exit 0002
:BEQ D32UX ;Z = 1 if division by zero. 6702
:BSR DIV32Z ;Do absolute value division. 6102
:D32UX RTS ;Exit information correct. 4E75
:
:...Unsigned division returning $FFFFFFF for zero division.
DIV32Z MOVEM.L D2/D3,-(A7) ;Save working registers, 48E7
: ;D2 and D3 to user stack. 3000
:MOVE.L D1,D2 ;Put divisor in D2 and 2401
:MOVEQ #0,D1 ;clear D1 for remainder. 7200
:MOVEQ #31,D3 ;Set 32-bit counter. 761F
:
:...Division loop - the complement of the last result bit is
:...looped round in the X flag to be shifted into the quotient,
:...(initially the input X flag is shifted into the quotient).
DIVLP ADDX.L D0,D0 ;Shift in last result, shift D180
: ;next d'dend bit to remainder. D381
:ADDDX.L D1,D1 ;Subtract divisor and skip, 9282
:SUB.L D2,D1 ;C = X = 0 = result if gone, 6402
:BCC DIVLPT ;else add it back, C = X = 1. D282
:ADD.L D2,D1 ;Repeat for 32 bits, sending 51CB
:DIVLPT DBF D3,DIVLP ;result bit to loop start. FFF4
:
:...One more shift moves final complemented result bit in to
:...quotient bit 0, and input X back to X flag. NOT complements
:...quotient to correct it, clears V and C, puts sign and zero
:...status of quotient in N and Z, leaving X unaffected.
:ADDDX.L D0,D0 ;Get last result, restore X. D180
:NOT.L D0 ;Correct quotient, set flags. 4688
:MOVEM.L (A7)+,D2/D3 ;Restore working registers, 4CDF
: ;D2 and D3, from user stack. 000C
:
:RTS ;Exit information correct. 4E75

```

COMPUTER ANSWERS

Simon Goodwin takes his toolkit to your problems. The address to write to is Computer Answers, PCW, 32-34 Broadwick Street, London W1A 2HG.

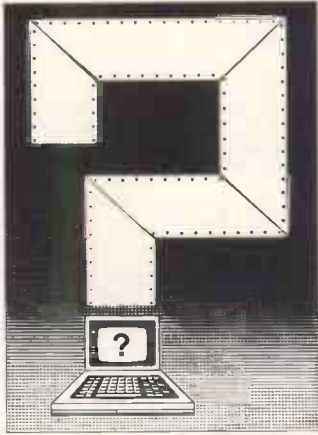

Fully covered

Could you tell me the names and addresses of any insurance companies which offer policies covering maintenance, and so on, for micros? My equipment is not an essential part of my business, therefore a repair time of up to seven days would be acceptable.
Glyn Taylor, South Kyme, Lincoln

The best choice of insurance depends to a great extent on the value of the equipment and its intended use. There are really two questions here — one about insurance policies, which offer you money if your computer is lost or damaged, and one about maintenance — prompt repair of a faulty computer.

If you want to insure a small system for personal use, you may be able to include it under your house contents or personal possessions insurance. In such a policy, the computer is treated like any other 'consumer durable' — washing machines, TV sets, record players, and so on. Some policies require that you list such items, with their serial numbers. An additional premium may be required if the computer is worth more than a certain amount, but this varies from one policy to the next.

Many house-contents policies will also cover your computer in transit to and from temporary sites, such as computer clubs. All reputable computer clubs should have their own insurance; the Association of Computer Clubs offers a range of schemes to member clubs at low prices. For more information, contact Rupert

Steele through PCW.

You should carefully check the small print of house-contents policies to make sure that your computer is covered. Some policies specifically exclude cover on software or equipment used for business rather than leisure; you may also have trouble arranging insurance cover for recorded data. In such cases, you have to rely on the broker to suggest an alternative.

High Street insurance brokers are only slowly becoming aware of the home computer market. Make sure they understand exactly what type of cover you require before you buy a policy, and get the brokers to confirm the cover with the company that actually issues the policy if there seems to be any doubt. Most brokers will phone and check at once if they are not sure whether a policy is appropriate.

As with car insurance, you are covered for different contingencies depending upon the amount you pay. 'All risks' cover generally provides insurance against accidental damage or breakdown, but cheaper policies may only cover fire and theft.

Computers used in offices may be covered under existing policies for typewriters, desks, coffee machines, and so on, but you should not assume that this is the case. Again, serial numbers and details of valuable items will be required by the insurers. Commercial Union Insurance and Eagle Star Engineering offer computer-specific policies for equipment worth more than a few hundred pounds. Halsey and Company is described as 'the Insurance Brokers for Computer People' — phone (0272) 503716 for details of their Repaircover and Datacover policies.

Of course, insurance may not fill your needs. It can take a while to get your money after equipment fails or is stolen; the insurance company will need to make enquiries before it pays out, and that could leave you computer-less for some time.

You should insure your computer as a matter of course, in case it is stolen, but there are a number of other actions which you might take if your policy does not

provide for a prompt replacement.

Probably the best idea is to come to some agreement with your supplier. Many big manufacturers (such as IBM, ACT and DEC) offer maintenance agreements which cover personal computers, but some of these are quite expensive — perhaps 20 per cent of the equipment value per year. The most expensive schemes offer same-day replacement of faulty machines, while others may only guarantee repair or replacement within a few days.

Most of the more professional computer dealers offer similar services for computers which they have supplied. Such cover can be convenient and cost-effective, especially if you are based close to the dealer's offices, but it is up to you to satisfy yourself that the dealer can be relied upon.

If you use a small computer it can be cost effective to buy more than one system, keeping one as a 'back-up', especially as the value of software and data soon outstrips that of hardware when a computer is in serious use. Some firms (including Mancomp (061) 224 1888 and Video Vault (04574) 66555) offer a 24-hour turn-round on small computer repairs (the BBC Micro, and soon). If you live near one of them, or can afford postal delays, you may be able to get by without a maintenance agreement.

Repairs to obscure machines, printers and disk drives tend to be slower, and it is often hard to find firms with the required specialist expertise. Your dealer may be able to advise you — local help is very valuable in such circumstances.

The best option for many business users will be leasing. Rather than buy your computer outright, you hire it from a specialist firm. If it breaks down, you are supplied with a replacement while the original is repaired (the arrangement is similar to TV rental). Leasing can seem fairly expensive, but it is convenient and often has tax advantages compared with the outright purchase of equipment. Micro leasing firms exist in most big cities — check *Yellow Pages* or magazine small ads for details.

Structured Basic

In the April issue of PCW, Brian Heywood pointed out that rational program control can be maintained by the judicious use of procedures and functions, and the risk of data corruption can be reduced by the use of local variables.

Could you publish a short list of computers that have such a Basic?
B Nesbit, Chopwell, Newcastle upon Tyne

The best 'structured Basic' is called Comal (COMMon Algorithmic Language). Comal is available for the BBC and most Commodore computers, including the 64.

BBC Basic on the BBC Micro, the Electron and the Tatung Einstein, has many structured features but some annoying limitations. For example, you can't return parameter values from a procedure (even functions only allow one value to be returned). Selection facilities are poor — IF..THEN..ELSE cannot be properly nested, and there is no CASE statement to resolve choice between more than two alternatives.

The Basic interpreter of the Enterprise is better in this respect; SuperBasic on the Sinclair QL is excellent, although it has a few bugs; RML Basic, for Research Machines computers, is worth examining, as is Apple's wonderful (but costly) Macintosh Basic.

As a last resort, you can buy programs which add a smattering of structured features to a built-in Basic. Popular choices are Simon's Basic for the Commodore 64 and MegaBasic for the Spectrum.

All structured Basics have a common weakness — they may allow you to structure your program, but they offer little in the way of facilities to represent data in a structured way. The records, sets, pointers and sub-range types in a full implementation of Pascal are invaluable if you really want to develop good programming habits.

Precise display

How do you quantitatively relate the resolving capability

of a domestic TV with aerial input, a domestic TV with RGB input, and computer monitors of medium, high and low resolution?

Presumably you count the number of pixels across and down the screen.

Perhaps you could expand on this point, as it appears that there is little available to provide meaningful comparison between the above. Some figures (in pixels?) for the above types of set would be useful.
DS Gladwell, Camborne, Cornwall

The resolution of a display is not easily expressed as a single statistic, which is probably why you can't find the comparative figures you describe. The resolution varies depending on several factors, including the brightness setting of the display (and thus, the ambient light level), the relative compatibility of the computer and display, the source of the signal and the information being shown.

A monitor should outperform a TV set, and a high-resolution display should give greater clarity than a low-resolution one. An RGB or composite video signal should give better resolution than a signal conveyed through a TV aerial socket, as less processing (and concomitant degradation) is needed to convert the signal into a form which can drive the display tube.

TV engineers measure resolution in terms of bandwidth, a measure of the number of changes which can be processed in a second. A respectable TV will have a bandwidth of at least 6MHz. Monitors range in bandwidth from 5MHz to 15MHz and beyond. The greater the bandwidth, the greater the precision. You can't make absolute statements about pixels (display dots) as different computers use different proportions of the screen area for a single pixel. The Sinclair QL, for example, uses twice the area used by the Spectrum. There is no standard size (or even shape) of pixel; as a very rough guide, a display with a bandwidth of 6MHz will blur information if it is asked to display more than about 300 pixels across the screen. You generally need a bandwidth of 10MHz or more to crisply display 80-column text.

When you examine a display, you should check that the 'white' display is even, with a rectangular border, and make sure that characters near either edge of the display

are not unacceptably distorted (or missing altogether). It is possible to adjust sets to reduce this type of distortion, but you should get the supplier to do this — there are potentially lethal voltages inside a TV set or monitor.

So far, this applies to black and white displays. When colour is added, the picture becomes even less clear. The format of television signals was decided before colour TV appeared, so PAL was invented to add colour information to a black and white signal. In the US and Europe, similar but incompatible systems are NTSC and SECAM.

All the colour encoding systems used in broadcasting suffer from weaknesses because they try to cram the colour information into a small bandwidth. Electronics in the receiver extracts the information, but this process is imprecise. Fringes of colour to one side of graphics on many micro displays are caused by inaccurate synchronisation between the brightness or 'luminance' information and the colour or 'chrominance' signal.

This problem occurs on all computers and TVs to some extent — it also crops up on video monitors connected via a composite video lead. Its severity depends upon the relative adjustment of the display and computer; the only way to avoid it is to try before you buy. There is a lot of variation in the performance of micros and displays — especially cheap models — so it is important to take your computer to the shop and leave with the particular display you found satisfactory.

It is possible to find a second-hand colour TV that will perform almost as well as a monitor if you shop around carefully, but you are unlikely to find a TV that performs as well as an RGB monitor. Colour TV pictures are built up from dots of three colours — red, green and blue (hence the name RGB). These displays require a separate feed to each of the 'guns' which produce coloured dots. The tubes are independently controlled, reducing interference problems and, in theory, giving the best possible display.

There are two types of RGB display — analogue and digital. Digital displays only allow one level of control over each gun, either on or off. This simplifies the electronics but restricts you to eight colours — the eight permutations of three binary

values.

With an analogue monitor the intensity of each gun can be set to any value, so you can use a potentially infinite variety of hues. In practice your computer will restrict you to a certain palette, but you will generally be able to use more than eight colours.

An analogue display is only useful if the computer has an analogue RGB output. You should check with your supplier if you are in any doubt about this.

Any colour display can suffer from alignment problems. In such a case, the relative positions of dots in each primary colour is skewed so that coloured shapes have borders in other, unwanted colours, and white displays will appear to be off-colour. These effects can be concealed if you test a display with text in primary colours on a black background, so you should also look at a range of colours on a white background. If the guns are misaligned, the white may look off-colour and there may be coloured fringes around some shapes.

Character study

I read with interest the article on the Oberon Omni-Reader in the April issue of PCW. Is there a machine that can read printed or photocopied text (with no limitation of typefaces), and read dot-matrix printing? What exactly is the 'learn mode'? What interface software is available?

Jesus Maria Boccio, Brussels, Belgium

We've had quite a few letters on this subject. Unfortunately, I know of no reasonably-priced machine that can read 'any' text, regardless of size or style. In essence, the problem is that there's so much variation between typefaces that the differences between one style and the next outweigh the similarities between identical letters.

Computers find distorted or patchy text hard to read, while humans can compensate for such errors without much effort. However, people often confuse characters which are mirror images of each other — 'b' and 'd', for example — while computers see such distinctions as clear cut.

Even the Omni-Reader, which can only read one typeface at a time, makes an occasional mistake. There's little doubt that more general reading machines will be developed, but it will take some time.

Generalised character recognition will certainly benefit from the availability of new microprocessors and algorithms (such as those used in speech and vision analysis), but it will be some years before the system you describe becomes available at a price comparable to that of a small computer. You should also bear in mind that such systems become less reliable as they are progressively made more flexible — a machine that can handle a mixture of four typefaces has more scope for error than one which confines itself to a single size and style.

Experimental systems to read handwriting are costly and unreliable at present, although simpler 'pattern-matching' systems which can recognise signatures are creeping onto the market.

Even the most expensive character readers (used by banks and large businesses) are restricted in the character sets they can recognise. In fact, the Omni-Reader performs well in comparison with many such devices, which often require special OCR character sets — letter-shapes which have been re-designed so that their differences are accentuated.

The oldest and tattiest of these shapes is called OCR A, the blotchy, rectangular style of lettering used along the bottom of UK bank cheques.

Oberon hopes to add a learn mode to future models of the Omni-Reader, which will allow you to 'teach' the machine a new typeface by presenting it with each symbol, and by telling the machine (probably via your computer keyboard) the corresponding character.

This is likely to be a fairly intricate process, and it will take care to get results as good as those for the pre-programmed typefaces, but it should allow you to process, for example, documents printed in a specific dot-matrix typeface.

The Omni-Reader uses a standard two-way RS232 interface, which means that it behaves very much like a remote terminal or telephone modem. You'll need to find a cable to link the reader to your computers — the device has a standard 25-pin D plug, then almost any communications package should allow you to copy data from the device to a disk file on your computer.

Oberon can supply specially-written software to link the reader with some common business computers. For further details, telephone (0442) 3803.

END

Paging Prestel

Improved access to Prestel and the low-down on PSS are covered by Peter Tootill in this month's round-up of networks news.

BT is introducing new equipment which will give improved access to systems such as Prestel and Telecom Gold. It will extend local call access to 96 per cent of telephone users, and provide a quicker connection. Most people call Prestel by dialling a three-digit code (often 618) but it can still take several seconds for the Prestel modem tone to appear. The new equipment is claimed to make the connection in half a second, and installation should be completed next year.

The local call access will include access to the Prestel editing computer, which is a big advance if you want to edit Prestel pages. At present you have to call a London telephone number.

The ClubSpot pages in the Prestel Microcomputing area should benefit from this. These pages are run by the ACC (Association of Computer Clubs) and are open to local computer clubs to edit. The club can put up details of its aims, programmes of meetings, and so on. One of the problems has been that many clubs have been unwilling to contribute because of the cost of the telephone calls involved. If your club is interested, contact the ACC at the address given in End Zone, page 230.

The new system will also provide 2400 bits/sec full duplex (CCITT V.22bis) access. This will be of academic interest to the average home user for the time being, as suitable modems are still uncommon and cost well over £500. However, prices should come down eventually—it's not long since a simple 300 bit/sec modem was expensive. Users with 300bit/sec modems will also be able to use Prestel, in the same way as can now be done via PSS.

PSS

PSS (Packet Switch Stream) is British Telecom's packet-switching data network. It is basically a network for data communication, in the same way that the ordinary telephone system is a network for voice communication. And, just as it is only worth having a telephone if other people you want to talk to have one, so it is only worth having a PSS account if the online systems you want to communicate with are connected to it. It isn't like Prestel, which is a system that you call for its own sake.

What will you find on PSS? There aren't many systems that are open to the public, most are for subscribers only. Indeed, to use many (such as Telecom Gold, Dialog, and so on) you don't even need to have your own PSS account; you just dial your local PSS access point (a local call for most people) and use the appropriate account number. One of the best-known systems that can be used by anyone who has a PSS account is Essex University's MUD, but this is only available during restricted hours. (There were rumours at the time of writing that Essex's MUD will be closing down, and that British Telecom has bought a new version (Son of MUD?) which I assume will be available on Telecom Gold where BT already has a number of games (see Chipchat PCW July).

Prestel can be used via PSS, and this enables people who haven't got 1200/75 modems (or who can't use them because their computer won't allow split baud rates) to use Prestel. The relevant PSS address (the PSS equivalent of the phone number) is A21920100620. Apparently, there is also a PSS address that gives you Prestel without the graphics, so you don't even need special software to use it. If you want to see what Prestel is like, there's a demonstration ID available—you use account number 4444444444, password 4444.

One of the advantages of PSS is that it is linked to other international packet networks, and you can communicate with systems in other countries much more cheaply than if you were to dial direct. For example, a phone call to the US works out at £35/hour (+ VAT) at cheap rate, and £43/hour at peak rates. PSS charges would come to between £10 and £15 per hour, depending on how much data is transmitted. In this way, you can use systems in the US such as The Source and CompuServe.

A PSS account costs £25 plus £6.25 a quarter. On top of this, there are time charges for inland calls of around £1 an hour and data charges of 15-25p per kilosegment (PSS insists on measuring data in 'segments'—one segment is 64 bytes). International calls cost from £1.32/hour and £1.20 per kilosegment

(Europe) to £6/hour and £4 per kilosegment for intercontinental calls. The costs work out at about £1.50 an hour for inland calls and £10 an hour for the US. Add about 50 per cent if you use a 1200/75 or 1200/1200 modem, as you can shift more data in the same time. On top of these, you still have ordinary telephone charges for the call to your local packet-switching exchange (PSE).

Why 'packet switching'? The name comes from the way the system works: it breaks your data into chunks, adds details such as who sent it, where it's going and how it fits together with the other blocks you send. These blocks are called 'packets'. Each packet, along with those from everyone else using the system at the same time, is sent independently on the network to the destination—your packets may not all go by the same route. At the other end, they are reassembled into your original data and passed to the system you are calling.

The thing that does the breaking up and reassembling of the data is called a 'PAD' (packet assembler/disassembler). The system is standardised internationally so that a British PAD can talk to an American PAD, and so on. The protocols used are specified by the CCITT X.25 standard (the CCITT is an international standards organisation).

Expensive calls

I have recently discovered that British local phone call charges are among the world's highest, but this may come as no surprise to you. What may come as a surprise is that our long distance and international calls are some of the cheapest in the world!

For example, a three-minute standard rate local call costs 11p in Britain, 6.5p in the US, and 6-7p in other European countries (in Canada, local calls are free!). A similar long distance call would cost 43-54p in the UK, 30-90p in Europe and around £1.20 in the US or Canada. International calls vary depending on distance, but from the UK, say £2-£3 for three minutes and £4 from the US or Canada. Germans would pay around £6! It can cost you less to call a US bulletin board from the UK, than an American calling long distance in his own country.

END

UK free networks

Bulletin Board	Phone Number	Notes
Aberdeen ITEC	(0224) 641585	V.23
BABBS-Bath	(0225) 23276	300/300 baud rate; 9pm-8am weekdays, 9pm-noon weekends; Atari-based system, ring-back system
BABBS-Felixstowe	(0394) 276306	300/300 baud rate; 24 hours daily; Apple users' group
BABBS TWO-Basildon	(0268) 778956	300/300 baud rate; 24 hours daily; Apple users' group with special area for queries to Apple UK
Basildon ITeC	(0268) 22177	Prestel type service
BASUE	(0268) 25122	Atari based 300 baud. 24 hour
Blandford Board TBBS	(01) 373 6337	24 hour
CABB TBBS	(0258) 54494	300/300 baud rate; 24 hours daily
CBBS SW	(01) 631 3076	300/300 baud rate; 24 hours daily + 1200/75
CBBS Surrey (Woking)	(0392) 53116	300/300 baud rate; 24 hours daily
Chatham (Kent)	(04862) 25174	1200/75 and 300/300 baud rates; 24 hours daily; jokes, jobs, reviews, news
CNOL Lancaster TBBS	(0634) 815805	6pm/9am daily + weekends 7 bits, even parity; sales and wants — cars, houses, computers
Computers Incorporated Newcastle (CBBS)	(0524) 60399	300/300 baud rate; 24 hours daily; Clinical Notes Online service, mainly for medical users; works in conjunction with a database on the Datastar network
Forum 80 Hull	(0207) 543555	300/300 baud rate; 24 hours daily; primarily business-oriented
Forum 80 SPA	(0482) 859169	300/300 baud rate; 5-11.30pm weekdays, noon-11.30pm Sundays, Bell 103 standard, midnight-8am daily; international electronic mail, library for up/downloading
Forum 80 Wembley	(0926) 39871	300/300 baud rate; 11pm-midnight daily; TRS-80 and Genie users' group
Fido Compulink	(01) 902 2546	300/300 baud rate; 7-10pm weekdays, midday-10pm weekdays; electronic mail, library for downloading; ring and ask for Forum 80
Fido Fastnet	(06286) 63571	24 hour
Fido Fore TBBS	(051) 260 5607	10pm-8am BELL 103/212a tones only at present
Hackney BBS	(01) 301 4110	Fido 1am-8am
Hamnet Hull	(01) 985 3322	V.23 Password: PUBLIC
Livingstone, Scotland	(0482) 497150	300/300 baud rate; 6pm-8am daily
London Underground	(0506) 38526	Atari, 24 hours daily
Liverpool Mailbox TBBS	(01) 863 0198	24 hours V.21/V.23 (Viewdata coming soon) BBC Based (colour for BBC users)
Mactel (Nottingham)	(051) 4288924	300/300 baud rate; 24 hours daily; sponsored by INMAC; electronic mail, program downloading, TRS-80 information; messages for PCW can be left on the board and will normally be read by us within 24 hours
Mailbox-80 W Midlands Stourport TBBS	(0602) 289783	V.21/V.23 Macintosh users 24 hours daily
Manchester Open Bulletin Board TBBS	(0384) 635336	300/300 baud rate; 6pm-8am daily
Marctel	(061) 7368449	300/300 baud rate; 24 hours daily + 1200/75
MBBS-Mitcham	(01) 346 7150	10am-10pm daily (24 hour coming, watch for announcement on Marctel) BBC based system (FBBS) with colour for Commstar users
MG-Net CBBS London	(01) 648 0018	300/300 baud rate; 24 hours; BBC-based system with jokes, graffiti, electronic mail, and Atari and BBC sections
Microweb Manchester TBBS	(01) 399 2136	300/300 baud rate; 5-10pm Sunday; electronic mail, program downloading
NBBBS-North Birmingham TBBS	(061) 4564157	300/300 baud rate; 24 hours daily; <i>Micro User</i> magazine, mainly for BBC users
NBBS-E BBC Micro	(0827) 288810	300/300 baud rate; 24 hours daily
NBBS Lutterworth	(0692) 630186	BBC Based 24 hours daily
NKABBS	(04555) 4798	Mon-Fri 8pm-11pm; Sat 9pm-10pm; Sun 9am-12.30pm
OBBS Manchester	(0795) 842324	9.30pm-midnight
Octopus RAS	(061) 4271596	300/300 baud rate; weekdays except 7pm-9pm, weekends except 10am-10pm
PIP-Sheffield TBBS	(0272) 421196 (Bristol)	6pm-8.30am V21 using public domain Octopus software
REACT UK	(0742) 667983	300/300 baud rate; 24 hours daily. Bell 9pm-8.00am
SABBS Glasgow	(0376) 518818	24 hours. Mainly Dragon
SBBS Southern	(0698) 884804	Atari, 24 hours daily
Southern BBS	(0923) 676644 (Watford)	11pm-8.30am daily; BBC based V.21/V.23
Stoke ITEC	(0243) 511077	300/300 baud rate; 8pm-2am daily; ring-back system (dial the number, let phone ring once, and then ring back); messages, downloading
Teletrieve (CTC)	(0782) 265078	300/300 baud rate; 24 hours daily; remote CP/M system
TBBS London	(0484) 657299	6pm-8am
TYNESIDE BBS	(01) 348 9400	300/300 baud rate; 9am-7pm daily
VISA	(091) 251 4271	V.21 BBC based
WABBS-Worthing	(01) 958 7098	8am-11pm daily V23 Prestel type
	(0903) 42013	300/300 baud rate; 24 hours daily; ring-back system (dial the number, let phone ring once, and then ring back); Atari-based

UK subscriber commercial/business systems

Bulletin Board	Phone Number	Notes
Comet	(0527) 28515	Message handling system: Details from Istel Ltd, Grosvenor House, Prospect Hill, Redditch, Worcs
Micronet 800	(01) 278 3143	Prestel database information for micro users. Details from Micronet 800, 8 Herbal Hill, London EC1R 5EJ
Prestel	Freefone 100	Subscribers only
Telecom Gold	Prestel sales (01) 403 6777	All information from Sales Admin, 60-68 St Thomas Street, London SE1 3QU

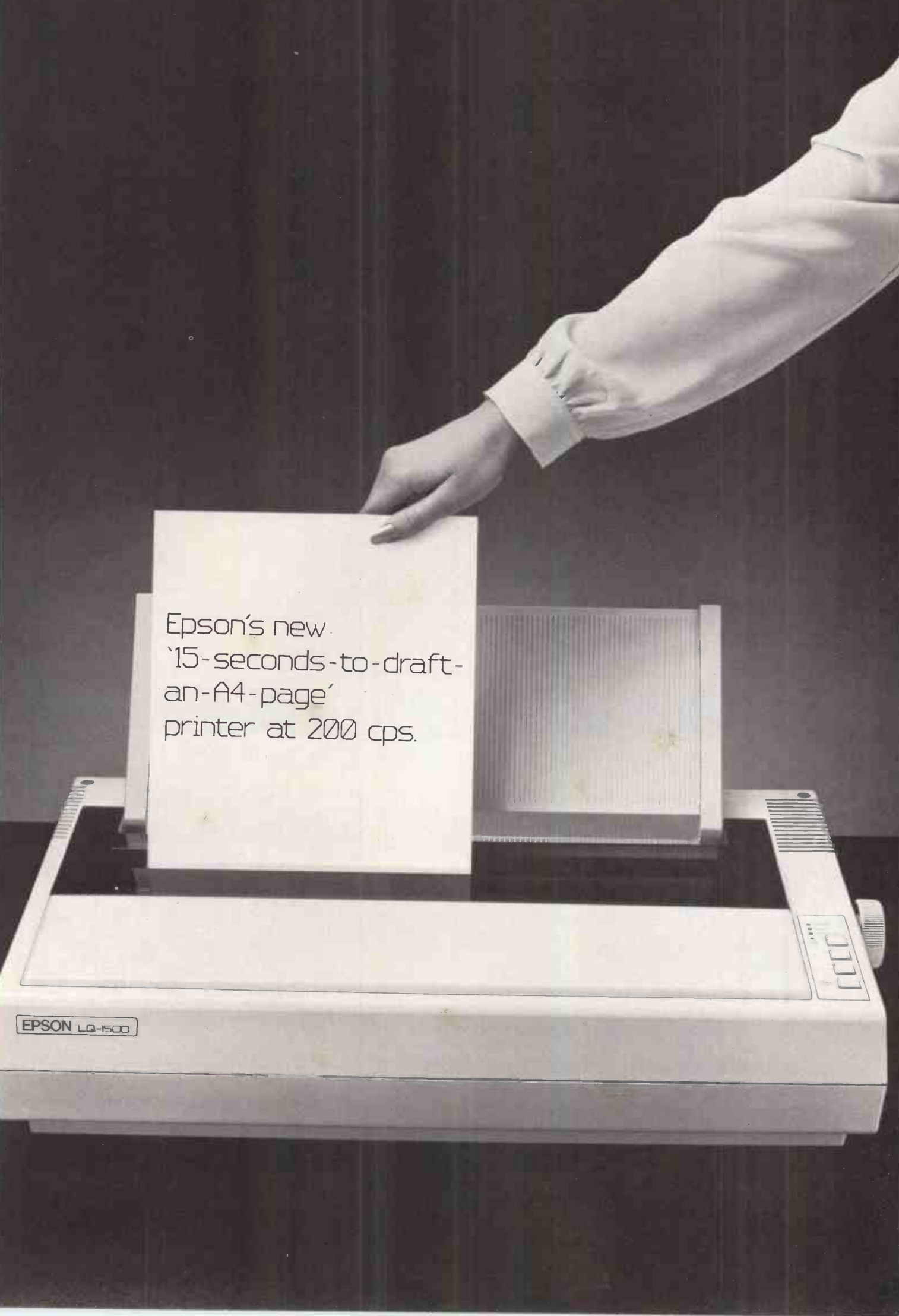
A black and white photograph of an Epson printer. A hand is shown placing a printed page into the printer's input tray. The page has text printed on it. The printer is a light-colored, rectangular device with a control panel on the right side. The background is dark and textured.

Epson's new
'15-seconds-to-draft-
an-A4-page'
printer at 200 cps.

EPSON LG-1500

TRANSACTION FILE

● **SUPERBRAIN II** QD. 64k RAM, RS232C, software and manuals for CP/M, SuperCalc, WordStar, SuperSort, DataStar, CBasic and WordMaster, £300. Tel: Boyce on 01-644 3546.
 ● **CANON P115GA**. 132 col printer, parallel interface, 160 CPS. Hardly used (original ribbon), £300 inc. Tel: Hogarth Watford (0923) 31289.
 ● **APRICOT 256k** computer, 2 x 720k drives. 12 in monitor and stand. Canon PW1156A 15in printer. Sage, Accounts, Payroll, Superwriter, Supercalc, Superplanner software, 20 spare disks. Cost over £3500. Unused in boxes. £2,950. Tel: 01-886 3268 (London).
 ● **OSBORNE 1** required. 52 column, double density version. Tel: Dave on Aberdeen (0224) 724291.
 ● **PROGRAM SET** — version 1.00. Perfect Writer, Speller, Calc, Filer for IBM-PC. Unused. What offers? Also latest IBM-PC version Flight Simulator. Cost £55, accept £30. No offers! Tel: Sid on 0438-736030.
 ● **IBM PC**: Basic compiler £160 — list £280, APL program £110 — list £190, 8087/8088 diagnostics £145 — list £246, Basic program development system £70 — list £120; no VAT! Tel: Hayling Island (0705) 468778.
 ● **SINCLAIR QL**, including all leads, user guide latest issue, software and microdrive cassettes, plus QL14 colour monitor, £395. Will split. QL £260, monitor £135. Tel: Abergelge 0745 823101.

● **COMMODORE 64 120**. Toshiba HX10 MSX, £190. Both new and boxed. Tel: 01-952 0687.
 ● **FOR SALE**. COMMODORE MPS801 printer. Brand new, never used. Unwanted gift, bargain at £175. Will post. Tel: (0427) 873-832 (anytime).
 ● **IBM PC Compatible** business computer. Complete with monitor and printer. Twin disk drives, large memory, manuals and all cables. Some software included, £1,595. Tel: (028 373) 3574.
 ● **APPLE II Europlus 48k**. Monitor, 2 disk drives, paddles, 80 column, colour, language, Centronics cards, Pascal, Logo, format 80, utilities, Appewriter I, Bit Copier, Books, £750 on no. Tel: (0304) 830790.
 ● **IBM-PC Bits Multiplan**, £70 — cost £140. Easywriter, £60 — cost £150. Basic compiler, £100 — cost £240. Math coprocessor, £100 — cost £215. APL, £90 — cost £175. Tel: Bob on (0705) 523859 (after 6pm).
 ● **TORCH-BBC** monitor, Perfect software, MBasic, BBC Basic Z80, DBase 2, Wordwise, Micronet, roms. Modem, mint condition, £1,100 on no. Tandy 3 48k dual drives, RS232, wordprocessor, mailer, database, Newdos-80, disc games (50+), £450. Tel: (07072) 65466.
 ● **SEIKOSHA GRAPHIC PRINTER**. — GP100A — for sale. Picture and graph output capabilities, input/output connector for Osborne/BBC. Excellent condition, £75. Tel: 01-789 2922 (eves and weekends).

● **GEMINI BOARDS**: GM813 cpu/RAM, £150, GM812 IVC, £100. GM829 FDC, £90. 8in drives, £100 each; or above as working system with cp/m, £450. Tel: (0689) 32344 (after 7pm).
 ● **BBC**: nine cassettes (games, utilities, music etc), nine books (programming, listings etc). All unused. Retail £150 approx, will accept £70 on no. 7 copies 84/85 Acorn User included free. Tel: Bennett on Newmarket 720619.
 ● **WANTED**. SHARP MZ700 floppy disc I/F and disc Basic, RS232 or Centronics I/F, software and compilers. Tel: (0604) 830399 (eves/weekends).
 ● **APPLE II Green Screen** Monitor. New and unused, in packing, with warranty card, £85. Beebug mags, vols 1-2 (20 issues) in binders. Cost £27, accept £12. Tel: 01-444 6244 (eves, N. London).
 ● **EPSON QX-10** plus Epson FX80 printer, barely used. 192k RAM, 2 x 320k floppies. Complete system including manuals and Peachtree software, £1,700 on no. Tel: 01-337 5663 (after 6pm).
 ● **TWO SINGLE SIDED** Micropolis 96tpi drives and two double sided 48tpi disk drives, each £35, in good working order. Tel: Douglas on Letchworth 79663 (eves only).
 ● **COMMODORE 64 PLUS** Datassette, plus software including 20 games. Boxed as new, £150. Also Mikro 64 cartridge, £45. Microvitec colour monitor, 6 months old, £195. Tel: 01-876 7250 (after 6pm).
 ● **NOVEX** hi-res, amber tube monitor. Boxed, hardly used,

£74. Also Brother EP22 typewriter/printer A/C adaptor, roll thermal paper, boxed, mint, £74. Tel: Haydn-Davies on Nottingham 203564.
 ● **WANTED**. Assembler program on cassette for Newbrain. Write, 74A Felpham Road, Felpham, Bognor Regis, West Sussex or Tel: (0243) 865264 (weekdays before 5pm).
 ● **APRICOT 27 x 315k** drives, Supercalc, Superwriter, etc. Plus Epson FX80 printer, other software, spare disks, all as new, £1,800. Tel: Fareham (0329) 221970.
 ● **SIRIUS WANTED!** Any model will do but must be in good working order. (Could offer F1 Apricot in part exchange). Tel: Linda on (0908) 310737 (days) or 318270 (eves).
 ● **'HALF PRICE'** BBC B. Over 500 cassette programs and original supporting manuals etc. Acoustic Coupler, Thorn EMI 2000, Micronet in ROM, VS IV cassette and disc. Software/ROMS: Wordwise Plus, Addcomm, G.Dump. Tel: (0278) 684116.
 ● **BBC B OS1.2** Watford DFS, Cumana CS100 disk drive, Microvitec, RGB colour monitor. All manuals including Advanced User Guide. Immaculate condition, £600. Tel: Sevenoaks (0732) 453744.
 ● **WANTED**. Software for Sirius 1, anything considered especially Basic compiler. Also any books on the operating system software. Tel: Mr Ward on Bradford (0274) 590824 (day) or 567570 (eves).
 ● **ADVANCE 86a** with 128k. Good working order plus

cassette recorder and leads. 8086 programming book (IBM comp), £195. Tel: Dave on Stevenage (0438) 356404.
 ● **TI PROGRAMMABLE-59 CALCULATOR**. Program storage up to 960 instructions, reads and writes magnetic cards, reciprocal keys, powers and roots, logarithms, angular mode keys and trigonometric keys. Including charger and personal programming manual, £25. Tel: Bordon, Hants (04203) 7194.
 ● **BBC MODEL B. OS1.2** with Cumana 100k single disk drive. Also Phillips cassette recorder and lots and lots of software on tape and disk, £400. Tel: Barry on (0446) 743534 (after 5pm).
 ● **SHARP MZ-80k**. 48k integral display and cassette, with Basic Plus, manuals, dust cover. Perfect condition, £89. Tel: Bolton (0204) 45246.
 ● **APPLE II+**. All peripheral cards (80-col, CP/M, PAL etc), monitor, two brand new drives, sixty disks of software, Wordstar, Visicalc, Supercalc, Pascal, tools, games, etc. Manuals, £970. Tel: 01-527 3294 (eves).
 ● **HITACHI COLOR PC**. MS-Dos, Microsoft, Cobol, Wordstar Professional, Calcmaster, Nucleus, plus other software books. All manuals, cables etc, still warranted, £1,595 on no. For details Tel: Caterham (0883) 47320 (eves).
 ● **BBC MODEL B. Kaga** green screen with Torch Z80 disk drives plus Perfect software and manuals. Wordwise ROM, Prism modem, plus ROM, £600 on no. Tel: Chris Clinch on Chichester (0243) 789915.

MICROCHESS

Good guys versus the bad guys — Kevin O'Connell referees.

Intelligent Software, includes chess programs among its range. Much time is spent testing them against other chess programs. Some of those test games deserve to see the light of day. Here is one of them that was played at 'blitz' speed — approximately five seconds per move for each program. I leave you to guess which program was written by Intelligent Software.

White: the Bad Guys' Program. Black: the Good Guys' Program. Opening: King's Indian Defence.

1	d2-d4	Ng8-f6
2	c2-c4	g7-g6
3	Nb1-c3	Bf8-g7
4	e2-e4	d7-d6
5	f2-f3	O-O
6	Bc1-e3	c7-c6
7	g2-g4	

(The 'Bayonet Attack', so-called because the thrust of the g-pawn, often backed up by the forward march of the h pawn, frequently proves fatal to Black.)

7	...	e7-e5
	(The most sensible answer to a flank attack is a central counter.)	
8	d4xe5?!	

(If White is serious about attacking on the king-side, then he should aim to keep the centre closed by playing 8 d4-d5. Flank attacks rarely prove successful if the defender can counter-attack in the centre.)

8	...	d6xe5
9	Be3-c5?	

(This is a completely wasted move, merely forcing Black's rook to move to a more central location.)

9	...	Rf8-e8
10	g4-g5	Nf6-d7
11	Bc5-e3	Qd8-e7

(Nicely judged. Black is now way ahead in development and has the more secure pawn structure.)

12	Qd1-a4	
	(Another irrelevancy, which further helps Black's development.)	
12	...	Nd7-c5

(Gaining still more time.)

13	Qa4-a3	Nb8-a6
14	O-O-O?!	

(White should only castle on the queen-side if his king-side attack is really going somewhere, which it is not, but he has already burnt his bridges.)

14	...	Bc8-e6
----	-----	--------



Burning bridges

15	b2-b4?	
	(Asking for even more trouble. Black has completed his development and has his king in safety so now White, with few pieces developed and his king comparatively in the open, decides to open up the game still more... oh dear!)	
15	...	Nc5-d7
16	c4-c5	Na6-c7!
	(Very nicely played.)	

A black and white photograph of an Epson printer. A hand from the right side of the frame is placing a wide sheet of paper into the printer's input tray. The paper has a perforated edge on the left side. The printer is a light-colored, rectangular device with a dark top surface. The background is dark and textured.

Epson's new
'widest-ever-spreadsheet'
printer.

EPSON LQ-1500



MICROCHESS

- 17 Bf1-e2 a7-a6
 18 Qa3-b2 Nc7-b5
 (Black continues to make steady progress.)
 19 Kc1-b1 Nb5-d4
 20 Be2-d3 a6-a5!

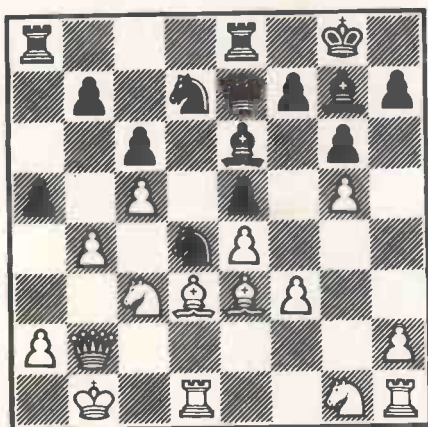

Opening up the attack

(Definitively opening up the queen-side and lines of attack against the white king.)

- 21 Nc3-a4 a5xb4
 22 Qb2xb4 b7-b5!
 (Winning a pawn, White's 'defences' in front of his king now disintegrate.)
 23 Na4-c3 Nd7xc5
 24 Qb4-b2 Nc5xd3
 25 Rd1xd3 b5-b4
 26 Be3xd4 e5xd4
 (26... b4xc3 also wins comfortably.)

- 27 Nc3-e2 Be6-c4

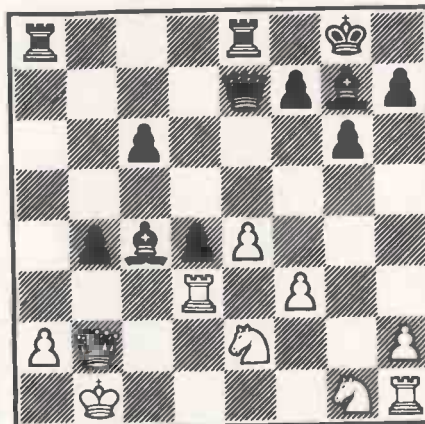

A touch of steel

- (Who has the bayonet now?)
 28 Qb2-c2
 (If the rook moves, then 28... d4-d3.)
 28 ... Bc4xd3
 29 Qc2xd3 Qe7xg5
 (So much for the 'cold steel' of this Bayonet Attack.)
 30 h2-h4 Qg5-g2
 31 Rh1-h3 c6-c5
 32 Qd3-c4 Qg2-f1+
 33 Kb1-c2 Re8-d8
 (Threatening 34... d4-d3+.)
 34 f3-f4 Ra8-a5
 35 e4-e5 Rd8-a8
 36 Kc2-b2 Qf1-g2
 37 Kb2-b1 Qg2-g4
 38 Qc4-d5 Bg7-h6

- (Forcing the gain of further material.)
 39 Rh3-f3 Qg4xh4
 40 Rf3-h3 Qh4-e1+
 41 Kb1-b2 Qe1-d2+
 42 Kb2-b1 Ra5xa2
 (White is dead, now it is merely a matter of playing on for as many moves as possible.)
 43 Qd5xa8+ Ra2xa8
 44 Rh3xh6 d4-d3
 45 Ne2-d4

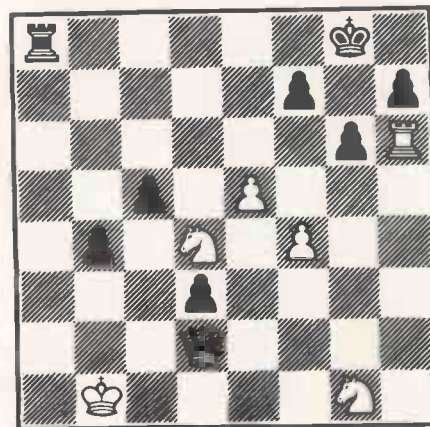

Just a formality

- 45 ... Qd2-e1+!
 (Black does not need any more material. The name of the game now is mate.)
 46 Kb1-b2 Qe1-a1+
 47 Kb2-b3 Qa1-a2 mate
 (Hooray for the good guys.)

NUMBERS COUNT

Mike Mudge presents a triad of number curiosities.

The following triad of number curiosities provides an opportunity for the computer user to explore untrodden paths. Requiring only a knowledge of simple arithmetic operations, the ability to recognise certain patterns among the digits of an integer and a certain enthusiasm; it is hoped that this choice will appeal equally to the new reader and to the regular correspondent.

1) Powers of ten may sometimes be factorised in manner that contains no zeros. For example:

$$10^2 = 4 \times 25$$

$$10^3 = 8 \times 125$$

$$10^{33} = 8589934592 \times$$

$$116415321826934814453125$$

Which powers of ten can be so factorised?

2) It can be proved that powers of two exist which contain arbitrarily long sequences of zeros. For example:

$$2^{10} = 1024$$

$$2^{53} = 9007199254740992$$

The first string of eight zeros is found in 2^{14007} and starts at the 729th decimal digit reading from right to left.

Which are the smallest powers of two

containing a string of zeros of a given length? Where does that string occur? Do similar results occur when the zero is replaced by another integer?

3) It can be proved that when a two digit decimal integer is multiplied by its 'reverse' the result is never a perfect square, unless trivially the integer is palindromic (that is equal to its 'reverse'). This does not extend to numbers of more than two digits for example:

$$169 \times 961 = 162409 = 403^2$$

$$1089 \times 9801 = 10673289 = 3267^2$$

These examples may lead to the conjecture that the product of a number and its 'reverse' (assumed now to be distinct) is only a square when both the number and its 'reverse' are perfect squares. Is this true? When are cubes or higher powers produced by multiplication of a number by its 'reverse'?

Readers are invited to submit their thoughts (preferably accompanied by computer related material!) relating to this triad of problems to Mike Mudge, 'Square Acre', Stourbridge Road, Penn, Nr Wolverhampton, Staffordshire WV4

5NF. Tel: (0902) 892141. A suitable prize will be awarded to the 'best' entry received by 1 November 1985. Criteria will include accuracy, originality and efficiency, not necessarily in that order.

Please note that submissions can only be returned if a suitable stamped addressed envelope is included. Expanded reviews of previous problems, together with, subject to the approval of the contributor, copies of detailed programmes from the prize winning entry may also be requested.

February winner

This problem produced a record response. I have many tables of palindromic primes and n^{th} powers both base 10 and numerous other bases; enquiries for particular sets of data would be welcome and all programmers suitably acknowledged. The mystery of the palindrome attempt function applied to 196 has remained unsolved.

Additionally much empirical evidence on palindromic geometrical numbers has been produced and very

A black and white photograph showing a person's hand in a light-colored sleeve holding a printed page just above an Epson printer. The printer is a light-colored, rectangular device with a paper tray on the left and a control panel on the right. The background is dark. The text on the page is centered and reads: 'Epson's new 'near-as-makes-no-difference-to-typewriter-quality' printer.'

Epson's new
'near-as-makes-no-
difference-to-
typewriter-quality'
printer.

EPSON LQ-1500

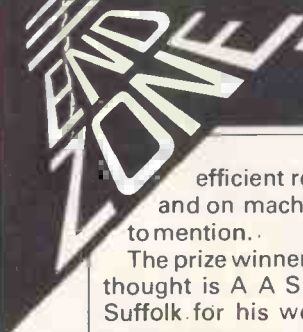

NUMBERS COUNT

efficient routines in languages, and on machines far too numerous to mention. The prize winner, after a great deal of thought is A A S Randall, Lowestoft, Suffolk for his work on a Dragon 32

using both Basic and machine code written and run using DASM/DEMON assembler and monitor from Com-pulse Ltd. Steve concentrated his efforts on squares, cubes, fourth powers, penta-

gonal numbers and of course the palindrome attempt function all in a range of number bases; leaving primes out of his study but presenting a well-documented and efficient set of results and programs.

LEISURE LINES

Brain-teasers from J J Clessa

Quickie

If I spend 25 per cent of the pounds in my wallet, and give away three-quarters of the rest, I'll have £6 left. How many pounds have I got?

Prize Puzzle

A bit easier than usual — but you will need your micros for it. What number when divided by 11 and multiplied by 13 gives the original number in reverse? Answers on postcards only (or backs of

envelopes) to PCW Prize Puzzle, August 85 Leisure Lines, 32-34 Broadwick Street, London W1A 2HG. Entries to arrive not later than 30 September 1985.

May Prize Puzzle

This one must have been a bit harder than usual, since only about 110 entries were received. One reader said he gave up on his own PC and used the larger machine at work.

At the time of setting the problem I only had one solution — 5671 which

splits into 2701, 1485, and 1485. As many of you pointed out, 5886 is also a solution — forming 1596, 2145 and 2145.

Both of these solutions can be deemed to be 'well over 5000 birds . . .' and therefore I accepted either for prize eligibility (the next solution was in excess of 12000 so was disqualified).

The winning entry came from Andrew Norris of Bridgwater, Somerset. Congratulations Andrew, your prize is forthcoming.

DIARY DATA

Readers are strongly advised to check details with exhibition organisers before making arrangements, in order to avoid wasted journeys due to cancellations, printer's errors, and so on.

London	(Barbican), Acorn User Show. Contact: Computer Marketplace Exbns Ltd, (01) 930 1612	25-28 July
London	(Olympia), Personal Computer World Show. Contact: Montbuild Ltd, (01) 486 1951	4-8 Sept
Esher	(Sandown Exbn Centre), Computers in Education Exbn — Teach Computer. Contact: TCM Expositions Ltd, (0428) 724 660	12-14 Sept
Manchester	(Belle Vue), Information Technology + Office Automation Exbn — Info North. Contact: BED Exbns, (01) 647 1001	17-19 Sept
Cardiff	(Nat Sports Centre), Technology Wales Exbn, Contact: Future Exbns Ltd, (0222) 490 355	18-20 Sept

WRITING FOR PCW

Your chance to contribute to the magazine.

We're offering readers a chance to get rich (well, at least richer) and to influence what's published in the magazine — by writing for it. We welcome approaches from would-be writers, including those who have never appeared in print before. It's often users with practical experience who have the most interesting things to say, so don't worry if your prose is less than perfect, we can take care of the

polishing.

If you have an idea for a feature write, with a brief synopsis, outlining the proposed structure and content. If your article is already written, then send it in for consideration. Remember to put your name and address on both the covering letter and the manuscript — along with a daytime phone number if possible. Manuscripts should be typed or printed out (dot matrix output is fine),

in double-line spacing with ample margins top and bottom and on each side.

Any accompanying program listings should be supplied on disk or cassette, ideally with a printout as well. We'll try to return all submissions sent in with a suitable sae, but make sure you keep a copy of everything you submit as well for reference.

Bear in mind that it's worth taking a

A black and white photograph of an Epson LG-500 adhesive label printer. A hand in a white sleeve is holding a vertical strip of three labels above the printer's output tray. The printer is light-colored with a dark control panel on the right side. The background is dark.

Epson's new
adhesive label
printer.

Epson's new
adhesive label
printer.

Epson's new
adhesive label

EPSON LG-500

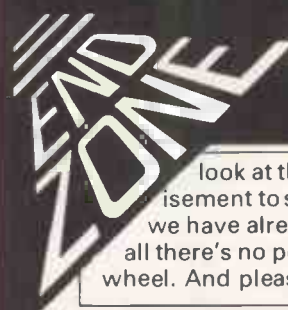

WRITING FOR PCW

look at the Back Issues advertisement to see what sort of things we have already published — after all there's no point in reinventing the wheel. And please be sure to tell us if

you've contacted another magazine (perish the thought): it would be very awkward if the same article appeared elsewhere. Frankly, we're more likely to accept something which has been

offered exclusively to us.

Finally, we do pay for published work — the rate is £65 per 1000 words, and payment usually follows about four-six weeks after publication.

ACC NEWS

Rupert Steele rounds up the clubs in the West.

The ACC (Association of Computer Clubs) is a non-profit organisation run by and for the computer clubs, which provides a way for computer clubs to make contact, and where practical to gain from joint schemes. The ACC is governed by a council consisting of representatives of all the affiliated clubs, although day-to-day matters are delegated to a committee. The ACC aims to be a truly national organisation, and its committee is drawn from around the country.

The most successful schemes to date have been the insurance policies. If you want to insure anything unusual (like a computer club), you can often pay £10 for the cover and £40 just to have the policy written out. By combining almost 200 clubs in a single scheme, the Association has been able to cut the cost dramatically. In fact, the public liability cover is included free for eligible (nearly all) clubs in the ACC affiliation fee. Through the ACC, a club can insure equipment at, or in transit to, its meetings for as little as £8 a year. Contact John Bone for written details of these schemes (see address below).

The ACC also provides two services to non-members, based on the national database of computer clubs that it holds and maintains. It answers a large number of enquiries from people wishing to find the address or phone number of their local computer club, or of the user group for their machine. The other service is for companies and other institutions wishing to mail material to computer clubs; the money raised from this is used to keep down the affiliation fee. Write to me for details of the schemes available (see address below).

ACC news goes West this month, starting with Shropshire. William Kitching writes to tell me of the Telford BBC User Group. For more information contact him at 1 Greenacres, Ketley Bank, Telford TF2 0DU. The Computer Programmers Club does not appear to hold meetings, but is a mail based club, run by John Bee Computer Programmers Club, PO Box 20, Salisbury, SP4 7JD. The idea is that budding software authors can have their creations marketed by the club in return for 80 percent of the proceeds. If your idea is a real winner, it's a rotten deal, but if your

program has a 'more selective appeal', then it's a good way to get it publicised and distributed. Of course, you may join the club simply to buy the software, the membership fee is £5 a year.

Moving on to Bristol, we come to a computer club that glows in the dark, The Nuclear Sports & Social Club — Personal Computer Group. The club is mainly for CEB employees at Berkeley Power Station, Oldbury Power Station, and Berkeley Nuclear Laboratories. Visitors are, however, welcome at most meetings, which are held at the Nuclear Sports and Social Club, Berkeley. It has a very full newsletter called EMU (you'll have to get a copy to understand the acronym), which contains lots of useful technical information and software reviews. For more information contact Mr W N Walker, 53 Wolfridge Ride, Alveston, Bristol, BS12 2PR or call Thornbury (0454) 414262.

Also in the West is Taunton Computer Club. I know very little about this apart from the contact: Christopher Blackmore, 27 Laburnum Street, Taunton, Somerset, TA1 1LB. Further west, we come to the Exeter & District Computer Club, which is open to everyone interested in computers in the area. Those who have yet to take the plunge and invest in a home micro may also benefit from the club. Contact Robert James of 13 Colleton Hill, Exeter, Devon, EX2 4AS or call him on (0392) 215134.

Heading on, we reach the Plymouth Micro club. I don't have a lot of data about this one, but the secretary is Dr Rory O'Neill of 48 Widewell Road, Roborough, Plymouth, PL6 7DW — or you can call (0752) 772484.

And that leaves two national/postal groups that are based in Cornwall. Paul Hills runs the 6809 User Group, and is a frequent correspondent. The group is hardware/software engineering based, with emphasis on the 6809 micro-computer chip; members get a quick reference card with all the 6809 assembler code instructions. Paul has asked me to point out that the membership fee has gone down; each issue of the mag is now 50p, with a year's membership being £3 (you can also get half-year membership for £1.50). Paul's address is 28 Woburn Road, Launceston, Cornwall PL15 7HH.

The other national group based in Cornwall is The Cuthbert Club, run by John Symes, of Microdeal Limited, 41 Truro Road, St Austell, Cornwall PL25 5JE. It is aimed at users of the Dragon micro, and it is offering free enrolment for any Dragon owner who has sent money to another so-called Dragon User Group, and received nothing. You get a free badge among the usual goodies.

Finally, three clubs from the Oxford area have written to me. An old favourite is the Oxford Personal Computer Club (OPeCC), which caters for all computer enthusiasts in the Oxford area. Meetings are held twice a month at the Donnington Community Centre, near Townsend Square, Oxford. Everyone is welcome at the meetings. For more information, contact the treasurer, Sebastian Linfoot, Flat 10, Pembroke Court, Rectory Road, Oxford OX4 1BY.

Also in Oxford is Oxon TI Users group for owners of Texas Instrument 99/4 and 99/4A home computers in Oxfordshire. There is a monthly newsletter called TI-Lines. The magazine contains information on all aspects of TI computers, with some more general computing information. A special feature is that, taking advantage of the 'speaking teletype' facilities available on some Texas models, a version of the newsletter, read onto audio tape, is available for blind or partially sighted TI owners. Contact: Peter Brooks, 29 Kestrel Crescent, Blackbird Leys, Oxford OX4 5DY.

And for the staff of Alex Lawrie Factors Limited, there is the Alex Lawrie Personal Computer Society. It has been running for about six months and has spent early days 'ploughing through' Basic programming.

For more information contact Robin Peers at Alex Lawrie, Beaumont Road, Banbury, Oxon OX16 7RN or call (0295) 67788.

For more information, write as follows: (for a mention in this column, to notify the ACC of a new or existing club, or to obtain club address labels): Rupert Steele, 12 Philbeach Gardens, London SW59DY. (Any other enquiry, including the address of your local club): John Bone, ACC Chairman, 2 Claremont Place, Gateshead, Tyne & Wear NE9 1TL or call 091-477 0036.

END

If you haven't guessed by now,
Epson's new printer is the
LQ 1500. It's everything in one.
And this is the coupon to
send off for details.
Or tel: EPSON FREEPHONE

Name _____

Position _____

Company _____

Address _____

PCW 885

To: Epson(UK.) Ltd.,
Dorland House, 388 High Road, Wembley, Middlesex, HA9 6UH.

EPSON LQ-1500

24 pin impact dot matrix, 200 cps, 67 cps NLQ mode, 101-406 mm paper width, up to 272 characters per line.
Options: single or double sheet feeder, tractor, parallel and serial 2K or 32K, IEEE 2K.

EPSON

FAST EFFICIENT REPAIR SERVICE

SPECTRUM . . . £18 inc

We also repair CBM64, VIC20, BBC, AMSTRAD, ORIC, DRAGON, disc drives and printers
RING FOR DETAILS

PRINTER BARGAINS

DATA DX120 PANTHER II NLQ.....	£320.85
MICRO P MP165 NLQ.....	£270.00
MICRO P CPA80.....	£199.00
CANON PW1156A.....	£416.30
CANON PW1080A.....	£328.90
JUKI 6100 DAISYWHEEL.....	£372.60
EPSON LX80 NLQ (new).....	£286.35
EPSON FX80.....	£395.00
EPSON RX80T.....	£232.30

DISK DRIVES

CUMANA CSX200D DS/40T.....	£121.50
CUMANA CSX400 DS/80T.....	£140.75
CUMANA CDX400D DS/40T Twin Drive.....	£231.60
CUMANA CD800S DS/80T Twin Drive.....	£302.40
UDM DDFS when bought with any disk drive.....	£90.00
UDM DDFS only.....	£105.00

All prices include delivery and VAT.
Please allow 14 days for delivery

Mail order customers make cheques payable to:

NEWCROWN COMPUTERS LTD

Dept PCW1
76B Dallow Road
Luton Beds LU1 1LY

Tel: (0582) 455684
Overseas enquiries welcome

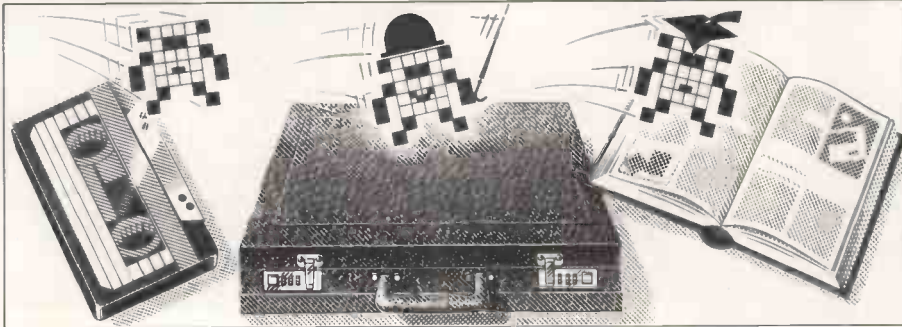

Owen Linderholm selects the best of reader's programs.

For details on submitting your own, see the end of this section.

To mark my debut as the person in charge of programs, and to accompany PCW's latest Teach Yourself series, I have chosen a couple of programs on the Logo theme. BBC Turtle Graphic is a program that gives you all the turtle graphics facilities of Logo, including programming, and has a shape-filling routine that is one of the best I've seen. The other program is a database written in Logo for the Spectrum, but is easy to convert to run on other machines.

On a more light-hearted note, there is a two-player QL memory game called Memoire that includes smooth-scrolling graphics, and Spectrum games players can try Nighthawk, a simulation of a combat helicopter that includes instrument and horizon displays.

For the BBC, there is a comprehensive version of Patience and also a

program that gives you an extra 28 colours in mode 2 by mixing the standard colours. For the Commodore 64, there is a game called Nest of Evil that includes a utility to allow you to move control sprites easily and smoothly from Basic. For the MSX range of machines, there is a 'platform-and-ladders' game which features Chas and some poisonous spiders.



Games



Scientific/mathematic



Business



Toolkit/utilities



Educational/Computer Aided Learning

256 COLOURS FOR YOUR BBC MICRO!!

The Colour Expander replaces the eight boring colours on the BBC micro with a selection of eight from 256. Every colour you could ever want is there: silvery greys, shades of brown, pinks, golds, subtle aquamarines, warm oranges, etc, etc.

Applications are almost unlimited. The most spectacular computer art is possible. 3D graphics using true shading techniques, fabulous games, business graphics enhancement, education etc.

The Colour Expander is a unique device which will open up a whole new world of graphics. It is compatible with most RGB monitors and comes complete with a cassette of demonstration and utility programs. The Colour Expander costs only £85 + (VAT + P&P) = £99.75. Also available as a module for OEM & scientific use.

5-INCH PORTABLE MONITOR

The immensely popular Hiltec TMC1R portable monitor with 5" monochrome CRT is ideal for computing on the move, portable business computing, home and professional video or any application where a really compact, lightweight, low power monitor is needed. It measures just 180mm x 105mm x 230mm and will run off mains or from mains or from batteries in its integral battery compartment. The TMC1R costs just £92 + (VAT + P&P) = £108.60.

PROFESSIONAL PAL ENCODER & UHF MODULATOR

A high quality PAL encoder module superbly designed by Hiltec. This unit accepts digital RGB inputs, (9 data lines allow 512 colours) and produces a 75 ohm PAL colour output together with a modulated UHF colour output. Digital timing techniques and state of the art ICs guarantee long and reliable operation together with high signal quality. Only £70 + (VAT + P&P) = £82.5.

Please send SAE for more information about any of these products.

HILTEC ELECTRONICS LTD

7 Airie Gardens, Campden Hill Road, London W8 7AJ

Tel: 01-727 5956 or 07987-316

Please allow 28 days for delivery. Mail Order only

NUMERIC KEYPAD

FOR THE BBC MODEL B

- Hooks into keyboard
- Not software driven
- Compatible with all commercial software
- Leaves all ports free
- Full travel key switches
- Includes RETURN key



CBM64 £29.95

ONLY **£44.95**

Inc P&P & VAT

Cheques/PO to:

COMMERCIAL PRODUCTS

Dept C, 11 Hylands Close, Furnace Green
Crawley, Sussex RH10 6RX

Tel: (0293) 31174



Program of the Month BBC Turtle Graphic by Christopher Rowett

If you've ever wanted to try turtle graphics but haven't been able to afford to buy a new language, then this program is the answer. It works on disk-based systems, but can be adapted for cassette by changing references to DFS commands such as OSCLI'DIR\$' in line 10, and by removing line 70 of the loader.

To type in and save the program:

1 Type in the first program and save it as TURTLE.

2 Type in the main program, exactly as shown and without extra spaces or there will not be enough room. Save it as TURTLE1.

3 Type in and run the third program. It will save a file called DATA.

4 To enter the machine code data, type in the fourth program and save it separately.

5 Run this program to enter the data

for FILL, DUMP, and VARCODE. Select option one (enter code).

6 Enter the hex start address (&900 for DUMP and VARCODE, &A00 for FILL).

7 Type in the first block of machine code data, byte by byte, typing XX to return to the menu when finished.

8 Select option three (save code), giving the filename FILL, DUMP or VARCODE, depending on which one you have been typing in.

9 To check the code, select option two from the menu.

10 Type in the hex start address.

11 The location and byte will be displayed. Hit any key to go on to the next location, or correct mistakes by typing X (to return to the menu), and then select option one and give the location of the mistake as the start address, correcting the byte and return-

ing to the menu. Save the corrected version as before.

12 Repeat steps six to eight for the other blocks of machine code data. The three are called FILL, DUMP and VARCODE respectively.

13 Now all you should need to do is run TURTLE.

The program supports all the turtle graphics commands given in Logo, and a list of these and their syntax can be obtained by typing HELP when the program has been run.

Variables must be single-letter lower-case letters, and everything else must be upper-case. Basic functions may be used in expressions, as may variables. There should be a space between

commands and their arguments, otherwise an error will be reported: FORWARD 50 is valid, but FORWARD50 is not. Recursion is supported, but not very far due to problems with the lack of space. Up to 10 nested repeats are allowed. When entering procedures, the editing commands are given by typing HELP.

Here is a sample program:

```
TO SQUARE n
REPEAT 4
FORWARD n
RIGHT 90
ENDREPEAT
END
```

This draws a square of size n when SQUARE n is typed.

```
10 MCODE:VDU23;B202;0;0;0;
20 FORAZ=9T016:PRINTTAB(35,AZ)CHR#156;TAB(3,AZ)CHR#132CHR#157;:NEXT
30 PRINTTAB(10,10)CHR#141;"TURTLE GRAPHICS"TAB(10,11)CHR#141;"TURTLE GRAPHICS"

40 PRINTTAB(5,15)"(C) 1985 Christopher Rowett"
50 PROCkeys
60 PRINTTAB(14,13)"LOADING"
70 PAGE=&1300
80 CHAIN"TURTLE1"
90 DEFPROCkeys: *FX18
100 RESTORE:FORAZ=0T09:READA=:OSCLI"KEY"+STR#AZ+A=:NEXT:ENDPROC
110 DATA"FORWARD ","BACK ","LEFT ","RIGHT ","REPEAT ","ENDREPEAT ","PENUP ","PENDOWN ","SHOWTURTLE ","HIDETURTLE "

10 OSCLI"DIR $":OSCLI"LOAD VARCODE 900":OSCLI"FX21,0"
20 MODE4:HIMEM=&5600:m=0
30 ONERRORGOTO220
40 DIMH$(33),C$(79),K$(33),A$(33),q1$(19),b(9),c(9),V(26),d$(19,79),12$(20),12(20),e2(20)
50 PROCe
60 OSCLI"TV0,1":OSCLI"FX12,5"
70 REPEAT:FORAZ=0T079:C$(AZ)=""::NEXT:PROCf
80 RZ=FALSE:PROCg
90 IFd2 d2=FALSE:GOTO80
100 IFh ANDNOT1 PROCch
110 UNTIL1
120 MODE4:HIMEM=&5600:GOTO50
130 DEFPROCp:PRINT"Ready,":h=FALSE:ENDPROC
140 DEFPROCc:PROCj:CLS:PRINTTAB(6)"TURTLE GRAPHICS VERSION 1.23":os=TRUE:d2=FALSE:p2=0:k=FALSE:l=FALSE:PROC1:PRINT:h=0:n=7:5%:0:XX=&40:Y%=&576:Z%=0:T%=TRUE:P%=TRUE:FZ=TRUE:XYZ=FALSE:az=&2020A:PROCc:PROCch:ENDPROC
150 DEFPROCf
160 REPEAT:PROCp:UNTILAS<>""
170 12%=A$
180 PROCq(A$):IFr GOTO160
190 ENDPROC
200 DEFPROCj:VDU26:GC0L0,7:MOVE0,128:DRAW0,1023:DRAW1279,1023:DRAW1279,128:DRAW0,128:VDU23;24586;0;0;0;28;10015;6172;4;132;1275;1019;:COLOUR131:COLOUR0:ENDPROC
210 DEFPROC1:X=OPENIN"DATA":FORAZ=0T033:INPUT#X,K$(AZ):NEXT:FORAZ=0T033:INPUT#X,H$(AZ):NEXT:FORAZ=0T033:INPUT#X,A$(AZ):NEXT:CLOSE#X:ENDPROC
220 REPORT:PRINT:GOTO70
230 GOTO70
240 OSCLI"FX21,0":END
250 DEFPROCq(A$):r=TRUE:IFRIGHT$(A$,1)="" A$=LEFT$(A$,LENAS-1)
260 IFLEFT$(A$,1)=""*ANDos OSCLIA$:ENDPROC
270 r=FALSE:PROCc(A$):ENDPROC
280 DEFPROCc(A$):LOCALAZ,BZ
290 AZ=INSTR(A$,""):IFAZ=0C$(BZ)-A$:CZ=BZ:ENDPROC
300 C$(BZ)=LEFT$(A$,AZ-1):A$=RIGHT$(A$,LENAS-AZ):BZ=BZ+1
310 GOTO290
320 DEFPROCg:AZ=0
330 AS=C$(AZ):PROCt(A$):IFNDTt PROCk(A$):IFNDTk PRINT"mistake: ";A$:ENDPROC
340 IFk GOTO1650
350 IFb/A$=a$
360 PROCw(A$)
370 AZ=AZ+1:IFAZ>CZ=TRUE:ENDPROC
380 GOTO330
390 DEFPROCt(A$):t=FALSE:LOCALAZ:bZ=FALSE
400 IFAS=K$(AZ)t=TRUE:ENDPROC
410 IFAS=A$(AZ)t=TRUE:bZ=TRUE:a$=K$(AZ):ENDPROC
420 AZ=AZ+1:IFAZ<346010400
430 ENDPROC
440 DEFPROCk(A$):k=FALSE:LOCALAZ
450 IFAS=q1$(AZ)k=TRUE:aZ=AZ:ENDPROC
460 AZ=AZ+1:IFAZ<20GOTO450
470 ENDPROC
480 DEFPROCv:PRINT"TURTLE GRAPHICS 1.23":VDU15:LOCALAZ,A$:FORAZ=0T033:PRINT$(AZ);";H$(AZ);";A$=GET:PRINT:NEXT:ENDPROC
490 DEFPROCw(A$)
500 IFAS="HELP"PROCv
510 IFAS="CLEARSCREEN"CLG:PROCc
520 IFAS="FENCE"FZ=TRUE
530 IFAS="WINDOW"FZ=FALSE
540 IFAS="PENUP"PZ=FALSE
550 IFAS="PENDOWN"PZ=TRUE
560 IFAS="SHOWTURTLE"ANDNOTT%T%=TRUE:PROCc
570 IFAS="HIDETURTLE"ANDT%T%=FALSE
580 IFAS="HOME"PROCx
590 IFAS="RESET"1=TRUE:AZ=CZ:ENDPROC
600 IFAS="FORWARD"PROCy
610 IFAS="LEFT"PROCz
620 IFAS="RIGHT"PROCa1
630 IFAS="PRINT"PROCb1
640 IFAS="BACK"PROCc1
```

data buffers

print buffers T-switches
buffered protocol converters
telecommunications buffers

Formats:

IEEE-488 or Centronics parallel, or V24/RS232c serial, or any conversion combination.

Buffer sizes:

From 2k to 1 megabyte RAM.

Computers:

IBM PC, Hewlett-Packard, DEC, Apple, Sirius/Victor, Televideo, Super Brain, Commodore, BBC, Tandy, Sharp, Osborne, NEC, Data-General, etc, etc.

Applications:

Input buffering (data collection, telecommunications, etc.).

Output buffering (accounts/payroll printing, plotting, graphics dumps, assembly listings, word processing, telecommunications, etc).

Support:

We are the leading specialist distributor of UK-designed buffered interfaces, with a range of products second to none in scope, price and reliability.

A»Line
Dataspeed Devices Ltd
MICRO BUFFER DISTRIBUTORS

3 Auburn Road
Laby
Leicester LE8 3DR
☎ 0533 778724

Your KEY to RECORD ACCESS is MULTIKEY

BASIC — compiled or interpreted. Includes card index demo.

'C' — Microsoft, Desmet, Lattice. Compiled library routines.

KEYS — Variable length, character string or integer.

ACCESS — Full, partial, combinations, sequences of keys.

FILES — Multiple index files. Joins data files.

B-TREE — For indexing, giving power with flexibility.

VALUE — £90 + VAT for single user BASIC version. £170 + VAT for multi-use 'C' versions.

MORE — Details on our fact sheet. Phone (0786) 85697 or write to CAIRN ASSOCIATES LTD, THORNHILL, STIRLING FK8 3PL.

CAIRN

DISKETTE Prices per box of 10		1 box	2-4	5-9	10+
3"	MAXELL	DS/DD 96*	40.00	38.00	37.00
3.5"	SONY	SS/DD 96*	30.00	29.20	28.40
		DS/DD 96*	42.00	40.00	38.80
		SS/DD 96*	33.00	31.80	30.60
5.25"	BASF	DS/DD 48*	16.00	14.63	14.22
		DS/DD 48*	19.00	17.44	16.95
		DS/DD 96*	20.00	18.56	18.05
		SS/DD 96*	23.00	21.38	20.78
		DS/HD 96*	41.00	37.69	36.64
5.25"	CENTECH	SS/DD 48	18.29	16.46	16.00
	11 colours	DS/DD 48	24.25	21.83	21.22
	to choose	SS/DD 96	24.25	21.83	21.22
	from	DS/DD 96	32.06	28.86	28.05
5.25"	CUMANA	DS/DD 96	16.25	14.63	14.22
5.25"	DYSAN	SS/DD 48*	17.00	16.31	15.96
		SS/DD 96*	25.00	23.85	23.19
		DS/DD 48*	31.50	30.26	29.42
		SS/DD 48*	11.00	10.48	10.19
5.25"	NASHUA	SS/DD 48*	12.00	11.20	10.88
		DS/DD 48*	14.00	13.27	12.90
		SS/DD 96*	15.00	13.99	13.61
		DS/DD 96*	16.50	15.38	14.95
5.25"	SCOTCH-3M	SS/DD 48*	15.00	14.06	13.67
		DS/DD 48*	19.00	17.44	16.95
		SS/DD 96*	22.50	20.53	19.66
		DS/DD 96*	24.00	22.80	21.88
8" BASF		FROM 12.64	8" NASHUA		FROM 12.86
8" DYSAN		FROM 22.10	8" SCOTCH-3M		FROM 14.34

Hard sector and pre-formatted diskettes also available.
 SOFTWARE - Available for:
 APRICOT, SIRIUS, MACINTOSH, APPLE (II, e, +, III), ATARI, C6M64, DEC
 RAINBOW, IBM (PC, XT, AT), TI PROF, WANG PC
 Framework 325 Multimate 230 Symphony 395
 Friday 130 SuperCalc 3 225 MS-Chart 175
 dBase III (1,1) 335 Jazz (Mac) 375 MS-Word 275
 Lotus 1-2-3 295 Wordstar 2000 295 Open Access 310
 Wordstar Pro! 255 dBase II (2,4,3) 240 Dets 4 350
 MS-Projekt 175 dBase II to III 100 TXI Solver (Mac) 145
 POSTAGE PER ORDER
 DISKS 2-4 Boxes £1, 5-9 Boxes £2, £2.50 per 10 Boxes.
 SOFTWARE £100-£300 Add £8, otherwise free delivery
 HARDWARE <£100 Add £5, £100-£500 Add £8, >£500 Add £10.
 ALL PRICES ARE EXCLUSIVE OF VAT
KINGSLEY ENTERPRISES
 87 Whitefield Road, Stockton Heath
 Warrington WA4 6NB
 Tel: 0925 64207

Budget

Typesetting

from your computer

Our customers have been typesetting books, magazines, brochures, ads and database files on their micros. Now they use

TYPENET

The on-line complete typesetting system operating 24 hours a day, every day. Why don't you join them and find out how you can save time and money?

Ring **01-658 6942** 300 BAUD
 or send for your info pack:
 LONDON, GLC & WEST OTHER AREAS
22 Queens Road 1 The Esplanade
Beckenham, Kent Rochester, Kent
01-658 8754 0634 41878
 Telecom Gold 83: BTLO01

Centronics or RS232 serial interfaces for **SHARP MZ 700**

also **PRINTERS and MODEMS**

Send for details: **PETERSON ELECTRONICS LTD**
 ACADEMY STREET, FORFAR, TAYSIDE DD8 2HA
 TEL: 0307 62591

```

650 IFA%="SETPOS"PROCd1
660 IFA%="COORDINATES"PROCY
670 IFA%="REPEAT"PROCE1
680 IFA%="ENDREPEAT"ANDRZ(C(SZ)=C(SZ)-1:IFC(SZ)>OAZ=b(SZ) ELSEIFA%="ENDREPEAT"A
NDRZ%SZ-1:IF%:(RZ=FALSE:SZ=0
690 IFA%="SAVE"PROCF1
700 IFA%="LOAD"PROCG1
710 IFA%="MAKE"PROCH1
720 IFA%="SETX"PROCI1
730 IFA%="SETY"PROCI1
740 IFA%="SETHEADING"PROCK1
750 IFA%="BACKGROUND"PROCL1
760 IFA%="PENCOLOR"PROCM1
770 IFA%="PENREVERSE"n=h:n=7
780 IFA%="PENERASE"n=h:n=0
790 IFA%="FILL"PROCN1
800 IFA%="TODSCL"FXZ29,1":os=FALSE:PROCTo:os=TRUE:OSCLI"FXZ29,0"
810 IFA%="EDIT"OSCL"FXZ29,1":PROCO:OSCL"FXZ29,0"
820 IFA%="END"ANDp2>0 CZ=e2(p2):AZ=12(p2):I2%=12%(p2):PROCC(12%):I2%*(p2+1)=""
12(p2+1)=0:e2(p2+1)=0:p2=p-1
830 IFA%="PRINTDUMP"OSCL"RUN DUMP":OSCL"LOAD VARCODE 0900"
840 ENDPROC
850 DEFPROC:XCOR=XZ:YCOR=YZ:HEADING=Z:IFNOTZENDPROC
860 GCOL3,3:MOVEXZ+FNx(3Z,Z),YZ+FNy(3Z,Z):Z=Z+140:IFZ>359Z=Z-360
870 MOVEXZ+FNx(3Z,Z),YZ+FNy(3Z,Z):Z=Z+80:IFZ>359Z=Z-360
880 PLOT85,XZ+FNx(3Z,Z),YZ+FNy(3Z,Z):Z=Z+140:IFZ>359Z=Z-360
890 GCOLh,n:ENDPROC
900 DEFPROC:PROCP1:PROCO:MOVEXZ,YZ:XZ=XZ+FNx(MZ,Z):YZ=YZ+FNy(MZ,Z):PROCU1:B
COLh,n:IFPZDRAWX,YZELSEMOVEXZ,YZ
910 PROCO:PROCP1:ENDPROC
920 DEFPROC:AZ=AZ+1:IFAZ>CZMZ=0:M=0:M%="" :ENDPROC
930 LOCAL T%:T%=C(AZ):UZ=ASC(T%)-96:PROCVars(C%(AZ))
940 M=EVAL(C%(AZ)):M%=C(AZ):MZ=M:C(AZ)=T%:ENDPROC
950 DEFPROCVars(A%)
960 %$A00=A%:CALL$900:IF?%70=0C%(AZ)=A%:ENDPROC
970 PROCs1(7%70,A%,?%71-96)
980 GOTD960
990 DEFPROC:1(B%,r):A%=LEFT$(B%,t1-1)+"V("+STR$(r)+")"+RIGHT$(B%,LENB%-t1):
ENDPROC
1000 DEFPROCC:PROCO:MOVEXZ,YZ:GCOLh,n:IFPZDRAW640,576ELSEMOVE640,576
1010 XZ=640:YZ=576:Z=0:PROCO:PROCP1:ENDPROC
1020 DEFFN:(AZ,B%)=FNv1(AZ%SIN(RAD(B%)))
1030 DEFFN:(AZ,B%)=FNv1(AZ%COS(RAD(B%)))
1040 DEFFNv1(A):IFA-INTA=-.5:INTA=INTA+1ELSE=INTA
1050 DEFPROCC:PROCP1:PROCO:Z=Z-MZ:IFZ>CZ=Z+360
1060 PROCO:ENDPROC
1070 DEFPROCa1:PROCP1:PROCO:Z=Z+MZ:IFZ>359Z=Z-360
1080 PROCO:ENDPROC
1090 DEFPROCl:PROCP1:h=0:n=7:VDUJ1,1,MZ,0,0,0:ENDPROC
1100 DEFPROCb1:PROCP1:PRINTM:ENDPROC
1110 DEFPROCCp:B%="" :LOCALAZ:AZ=FALSE
1120 A%=GET$:IFA%<"ORAZ">CHR$(127)ANDA%<CHR$(13)ANDA%<CHR$(21)GOTO1120
1130 IFA%="CHR$21"ANDB%="" :GOTO1120
1140 IFA%="CHR$21"ANDB%="" :GOTO1120
1150 IFA%="CHR$13"ANDB%="" :PRINT:ENDPROC
1160 IFA%="CHR$(127)ANDB%="" :GOTO1120
1170 IFA%="CHR$(127)&RIGHT$(B%,1):B%=LEFT$(B%,LENB%-1):PRINTCHR$(127);GOTO1120
1180 IFA%="" :AND(B%="" :ORAZ)GOTO1120
1190 IFA%="" :AZ=TRUE ELSEAZ=FALSE
1200 IFLENB%>158VDU7:GOTO1120
1210 B%=B%+A%:PRINTA%:GOTO1120
1220 IFC%="" :AZ=FALSE
1230 GOTO1120
1240 DEFPROCC1:PROCP1:PROCO:MOVEXZ,YZ:XZ=XZ-FNx(MZ,Z):YZ=YZ-FNy(MZ,Z):GCOLh,n
:IFPZDRAWX,YZELSEMOVEXZ,YZ
1250 PROCO:PROCP1:ENDPROC
1260 DEFPROCD1:PROCO:MOVEXZ,YZ:GCOLh,n:PROCP1:XZ=MZ:IFPROCP1:YZ=MZ:IFPZDRAWX,YZ
ELSEMOVEXZ,YZ
1270 DEFPROCE1:PROCO:MOVEXZ,YZ:GCOLh,n:PROCP1:XZ=MZ:IFPZDRAWX,YZELSEMOVEXZ,YZ
1280 PROCO:PROCP1:ENDPROC
1290 DEFPROCF1:PROCO:MOVEXZ,YZ:GCOLh,n:PROCP1:YZ=MZ:IFPZDRAWX,YZELSEMOVEXZ,YZ
1300 DEFPROCG1:PROCO:PROCP1:Z=MZ:PROCO:ENDPROC
1310 PROCO:PROCP1:ENDPROC
1320 PROCO:PROCP1:ENDPROC
1330 DEFPROCH1:PROCP1:XYZ=MZ:ENDPROC
1340 DEFPROCI1:IFXZ&Z&=10:PRINT"X=";XZ,"Y=";YZ:AZ=&2020A
1350 ENDPROC
1360 DEFPROCL1:LOCALBZ,CZ:CZ=FALSE:BZ=LENB%:IFRIGHT$(B%,1)="" :B%=LEFT$(B%,LENB%
-1):PRINTCHR$(127);IFB%="" :AZ=FALSE:ENDPROC
1370 IFRIGHT$(B%,1)<" " :ANDB%<" " :B%=LEFT$(B%,LENB%-1):PRINTCHR$(127);GOTO1370
1380 AZ=TRUE:ENDPROC
1390 DEFPROCE1:PROCP1:IFMZ=0ENDPROC
1400 SZ=SZ+1:RZ=TRUE:c(SZ)=MZ:b(SZ)=AZ:ENDPROC
1410 DEFPROCF1:AZ=AZ+1:IFAZ>CZM%="" :ELSEM%=C%(AZ)
1420 X=OPENOUT(M%):LOCALAZ,BZ:FORAZ=0TOm-1:PRINT#,q1$(AZ):BZ=0:REPEAT:PRINT#,
d$(AZ),BZ):BZ=BZ+1:UNTILd$(AZ,BZ-1)="END":NEXT:PRINT#, "FINISH":CLOSE#;C%(AZ)
1430 DEFPROCG1:AZ=AZ+1:IFAZ>CZM%="" :ELSEM%=C%(AZ)
1440 X=OPENIN(M%):LOCALAZ,BZ,A%:m=0
1450 INPUT#,A%:IFA%="FINISH"CLOSE#;ENDPROC
1460 m=m+1;q1$(AZ)=A%:BZ=0:REPEAT:INPUT#,d$(AZ,BZ):BZ=BZ+1:UNTILd$(AZ,BZ-1)="E
ND":AZ=AZ+1:GOTO1450
1470 DEFPROCH1:LOCALDZ:PROCP1:DZ=UZ:PROCP1:V(DZ)=M:ENDPROC
1480 DEFPROCI1:PROCP1:VDUJ1,0,MZ,0,0,0:ENDPROC
1490 DEFPROCL1:PROCO:IFPUTIN(XZ,YZ)<>PROCO:ENDPROC
1500 GCOL0,0,?%76=XZMOD256:7%77=XZDIV256:7%78=YZMOD256:7%79=YZDIV256:OSCL"FILL
" :OSCL"LOAD VARCODE 900":PROCO:ENDPROC
1510 DEFPROCU1:IFNOTZENDPROC
1520 IFZ>1275ORXZ<4ORYZ<132ORYZ>1019XZ=XCOR:YZ=YCOR
1530 ENDPROC
1540 DEFPROCTo:IFA=20PRINT"no more room":AZ=CZ:ENDPROC
1550 AZ=AZ+1:IFAZ>CZPRINT"Missing name":ENDPROC
1560 q1$(m)=C%(AZ):VZ=0:LOCALG%,H%
1570 PROCP1:IFM%="" :GOTO1590
1580 d$(m,VZ)=M%:H%=MID$(M%,2,LENM%-1):G%=G%+CHR$(96+EVALH%)+"" :VZ=VZ+1:GOTO15
70
1590 PROCx1("DEFINING "+q1$(m)+CHR$(13)+CHR$(10)+G%)
1600 PROCf
1610 d$(m,VZ)=A%
1620 VZ=VZ+1
1630 IFC%(CZ)<>"END" :GOTO1600
1640 PROC:CLS:CLG:PROCO:PRINTq1$(m);" DEFINED":m=m+1:ENDPROC
1650 DZ=0
1660 IFLEFT$(d$(aZ,OZ),2)="" :V("THENZ=EVAL(RIGHT$(d$(aZ,OZ),LEN(d$(aZ,OZ))-1)):P
ROCP1:V(OZ)=MZ:OZ=OZ+1:GOTO1660
1670 p2=p2+1:I2%(p2)=I2%+I2(p2):AZ=e2(p2):CZ=AZ=0
1680 I2%="" :REPEAT:I2%=I2%+d$(aZ,OZ)+"" :OZ=OZ+1:UNTILd$(aZ,OZ-1)="END"
1690 PROCG(12%):k=FALSE:d2=TRUE:ENDPROC
1700 DEFPROCO:AZ=AZ+1:IFAZ>CZPRINT"Missing name":ENDPROC
1710 PROCK(C%(AZ)):IFNOTK PRINT"Undefined word":ENDPROC
1720 LOCALUZ,VZ:PROCI1("EDITING "+q1$(aZ)):AZ=&10
1730 IFLEFT$(d$(aZ,VZ),2)="" :V("VZ=VZ+1:GOTO1730
1740 CZ=VZ
1750 IFd$(aZ,VZ)="END" :eZ=VZ-1:GOTO1770
1760 PRINTUZ;" " :d$(aZ,VZ):UZ=UZ+1:VZ=VZ+1:GOTO1750
1770 PROCH:PROCF:IFLEFT$(A%,6)="" :CHANGE"GOTD1840
1780 IFLEFT$(A%,4)="" :HELP"PRINT"Edit mode"" :CHANGE <line no.>"" :DELETE <line no.

```

PROGRAM FILE

```
>""HELP""INSERT <before line no.>""LIST""QUIT":GOTO1770
1790 IFLEFT$(A$,6)=-"DELETE"GOTO1870
1800 IFLEFT$(A$,4)=-"QUIT"PROCJ:CLS:CLG:PROCo:k:FALSE:ENDPROC
1810 IFLEFT$(A$,4)=-"LIST"GOTO1900
1820 IFLEFT$(A$,6)=-"INSERT"GOTO1910
1830 PRINT" Mistake":GOTO1770
1840 IFLENAS=6 INPUT"Which line:" AZELSEAZ=EVAL(RIGHT$(A$,LENAS-6))
1850 IFAZ>(e%-s%)ORAZ<OPRINT" No such line":GOTO1770
1860 PRINTd$(aZ,sZ+AZ):PROCf:d$(aZ,sZ+AZ)=A$:GOTO1770
1870 IFLENAS=6 INPUT"Which line:" AZELSEAZ=EVAL(RIGHT$(A$,LENAS-6))
1880 IFAZ>(e%-s%)ORAZ<OPRINT" No such line":GOTO1770
1890 FORBZ=eZ+AZ:DOeZ:d$(aZ,BZ)=d$(aZ,BZ+1):NEXT:d$(aZ,BZ)="" :eZ=eZ-1:GOTO1770
1900 UX=0:FORBZ=eZ:DOeZ:PRINT:UX: " ";d$(aZ,BZ):UX=UX+1:NEXT:GOTO1770
1910 IFLENAS=6 INPUT"Which line:" AZELSEAZ=EVAL(RIGHT$(A$,LENAS-6))
1920 IFAZ>(e%-s%)ORAZ<OPRINT" No such line":GOTO1770
1930 IFeZ=7B PRINT" No room":GOTO1770
1940 FURBZ=eZ+210sZ+AXSIEP-1:d$(aZ,BZ)=d$(aZ,BZ-1):NEXT:eZ=eZ+1
1950 PROC:d$(aZ,sZ+AZ)=A$:GOTO1770
1960 DEFPROC:1(V%):CLS:PRINTV%:PKCo:CLG:VDU2B,1,26,3B,1:COLOUR12B:COLOUR7:ENDP
ROC
```

```
10 X=OPENOUT"DATA"
20 RESTORE
30 REPEAT
40 READA$
50 PRINT#X,A$
60 UNTILAS="WD"
70 CLOSE#X
80 DATABACKGROUND,BACK,CLEARSCREEN,COORDINATES,EDIT,END,ENDREPEAT,FENCE,FILL,
FORWARD,HELP,HIDETURTLE,HOME,LEFT,LOAD,MAKE,PENCOLOUR,PENDOWN,PENERASE,PENREVERS
E,PENUP,PRINT,PRINTDUMP,REPEAT,RESET,RIGHT,SAVE,SETHEADNG,SETPOS,SETX,SETY
90 DATASHUNTURTLE,TO,WINDOW
100 DATA<numeric>,<numeric>,"",<O/I>,<name>,"",",",",",",",<numeric>,"",",",",",<n
umeric>,<fsp>,<letter> <numeric>,<numeric>,"",",",",",<numeric>,"",<numeric> <es
tatement> ENDREPEAT,"",<numeric>,<fsp>,<numeric>,<numeric> <numeric>
110 DATA<numeric>,<numeric>,"",<name> <statement> END,""
120 DATABG,BK,CS,CO,ED,"",ER,FE,FL,FD,HL,HT,HM,LT,LD,MK,PC,PD,PE,PR,FU,FT,PDF,
RE,RS,RT,SV,SETH,SETP, SX,SY,ST,"",WD
```

```
10 MODE7:PRINT"" 1 Enter code"
20 PRINT"" 2 Check code"
30 PRINT"" 3 Save code"
40 PRINT"" Select option";
50 AS=GET$:IFAS<"1"ORA$>"3"GOTO50
60 IFAS="1"PROCcenter:GOTO10
70 IFAS="2"PROCcheck:GOTO10
80 INPUT"Enter filename:" A$
90 DSCL"SAVE "+A$+" "+STR$S$+" "+STR$E$
100 GOTO10
110 DEFPROCcenter
120 INPUT"Enter start address &" A$:AZ=EVAL("&"+A$)
130 IFAZ>AFFORAZ<&900 VDU7:PRINT"Illegal start":GOTO1020
140 SZ=AZ
150 PRINT AZ;"&";:INPUT"" V$
160 IFLENV$<2 VDU7:PRINT"Error":GOTO150
170 IFV$="X"ENDPROC
180 VZ=EVAL("&"+V$)
190 ?AZ=VZ
200 AZ=AZ+1:EZ=AZ:GOTO150
210 DEFPROCcheck
220 INPUT"Enter start address &" A$:AZ=EVAL("&"+A$)
230 IFAZ>AFFORAZ<&900 VDU7:PRINT"Illegal start":GOTO220
240 PRINT AZ;"&"; ?AZ
250 AS=GET$:IFAS="X"ENDPROC
260 AZ=AZ+1:IFAZ<AFFGOTO240
270 ENDP:KUC
```

```
>
0000 A9 01 85 71 A9 00 85 70 ...q...p
0008 20 DE 0A 20 93 0A A4 71 ...q...q
0010 B9 00 56 85 72 B9 00 57 ...v.r...w
0018 85 73 B9 00 09 85 74 B9 ...s...t.
0020 00 0C 85 75 E6 71 A5 72 ...u.q.r.
0028 85 76 A5 73 85 77 A5 74 ...v.s.w.t
0030 18 69 04 85 78 A5 75 69 ...i.x.u.i
0038 00 85 79 20 93 0A A5 72 ...y...r.
0040 85 76 A5 73 85 77 A5 74 ...v.s.w.t
0048 38 E9 04 85 78 A5 75 E9 B...x.u.
0050 00 85 79 20 93 0A A5 72 ...y...r.
0058 18 65 78 85 76 A5 73 69 ...ee.v.si
0060 00 85 77 A5 74 85 78 A5 ...w.t.x.
0068 75 85 79 20 93 0A A5 72 ...y...r.
0070 38 E5 78 85 76 A5 73 E9 B.e.v.s.
0078 00 85 77 A5 74 85 78 A5 ...w.t.x.
0080 75 85 79 20 93 0A A5 70 ...y...p.
0088 18 69 01 C5 71 F0 03 4C ...i...q...L
0090 0E 0A 60 A2 76 A0 00 A9 ...v...
0098 09 20 F1 FF A5 7A C9 00 ...z...
00A0 F0 01 60 A9 19 20 EE FF ...E...v.
00AB A9 45 20 EE FF A5 76 20 ...E...v.
00B0 EE FF A5 77 20 EE FF A5 ...w...
00BB 78 20 EE FF A5 79 20 EE ...x...y.
00C0 FF 20 C5 0A 60 E6 70 A4 ...p...
00CB 70 A5 76 99 00 56 A5 77 p.v.v.v.w
00D0 99 00 57 A5 78 99 00 09 ...w.x...
00DB A5 79 99 00 0C 60 A9 87 ...y...t.
00E0 20 F4 FF B9 E9 0A 85 7B ...e...e
00EB 20 02 04 0B 00 04 0B 00 ...e...e
00F0 00 ** ** ** ** ** ** ** ** ** **
```

MICROMART

BEST UK SOFTWARE PRICES

Buy from TriSoft Ltd., the specialist software company formed by microcomputer consultants.
 * Over 400 leading software packages (inc. Apple)
 * Independent advice in making your choice
 * Professional staff + network of consultants
 * Most formats. All programs latest versions

SAGE ACCOUNTS £245 SAGE PLUS £485

	List Price	Our Price		List Price	Our Price
* dBase II	395	239	KnowledgeMan	450	359
Open Access	550	325	Superproject	395	299
Supercalc II	195	145	DR C Compiler	295	225
Supercalc III	360	199	MS Basic Comp	385	299
Multiplan	190	145	MS Pascal	295	235
* WordStar Prof	399	265	Data Plot Plus	195	155
Multimate 3.3	399	265	Ascom	170	149
DMS Delta 4	495	375	MS Word	400	299

SPECIAL OFFERS IBM/APRICOT ONLY

FOR JULY/AUGUST ONLY, OR WHILE STOCKS LAST

dBASE II
 Δ dBASE III
 FRAMEWORK
 LOTUS 1-2-3
 SYMPHONY
 WORDSTAR PROF
 Δ WORDSTAR 2000
 Δ — NOT AVAILABLE FOR THE APRICOT

PEGASUS ACCOUNT

All prices exclude VAT and carriage.
 If you see any of these products genuinely advertised at a lower price we will improve upon that offer in most cases. Please phone or write for our comprehensive price list.

DEALER, CONSULTANT, GOVERNMENT AND OVERSEAS ENQUIRIES WELCOME

TriSoft Ltd
 Crown Square, Matlock,
 Derbyshire DE4 3AT
 Tel: 0629-3021 (6 lines)

COMMODORE 2001-3000 4000-8000

We have the world's largest selection of software for the PET/CBM range. We supply to schools, universities, large and small companies, government departments, and of course home users.

We also manufacture add-on boards and plug-in chips that can make your computer more powerful — the most popular add-ons are our high resolution graphics boards which give your PET better resolution than an Apple!

IF YOU OWN OR USE A PET/CBM COMPUTER WRITE OR PHONE FOR A FREE CATALOGUE. By the way, we also offer software for the Commodore 64.

SUPERSOFT

Winchester House, Canning Road, Wealdstone,
 Harrow, Middlesex, HA3 7SJ
 Telephone: 01-861 1166

BRAIN SURGEONS

Anita Electronic Services (London) Ltd. are specialists in the repair and service of the Superbrain and associated peripherals.

We offer a fast on-site nationwide service or alternative repairs can be carried out at our workshops should you wish to bring your machine in to us.

Maintenance contracts are available at very competitive prices.

We also specialise in the repair of Commodore, Apple, IBM Apricot, Osborne and Sirius.

Trade enquiries welcome

For further information telephone or write to:—

Mr. D. Wilkinson
Anita House,
15 Clerkenwell Close,
London EC1R 0AD
Tel: 01-253 2444

TYPESET DIRECT FROM DISK

✦ Anvil direct typesetting from micro disks puts you firmly in control of your photo-typesetting.

Mark up your text using your usual wordprocessor commands (as long as you are using WordStar, Wordwise or another similar CP/M, MS-DOS or PC-DOS wordprocessing program).

✦ TypeFit software copyfits (casts off) your text files on your micro in exactly the same way as a photo-typesetter.

Create copyfitted wordprocessor files which can be typeset line-for-line and character-for-character.

Write or telephone now for details of low-cost TypeFit demo software and FREE Anvil typesetting offer.

Wordsmiths

33 Clerkenwell Close • London EC1
☎ (01) 608 1868
19 West End • Street • Somerset
☎ (0458) 45359



ALL TYPES OF BUSINESS COMPUTER SYSTEMS BOUGHT, SOLD AND EXCHANGED
BESPOKE PROGRAMMING SERVICE IN BASIC, COBOL OR PASCAL
ALL TYPES OF NEW EQUIPMENT SUPPLIED

Telephone:
0602 761504/278620

D+R COMPUTER SERVICES

```
0000 A9 02 20 EE FF A9 01 20 .....
0008 EE FF A9 1B 20 EE FF A9 .....
0010 01 20 EE FF A9 41 20 EE .....A..
0018 FF A9 01 20 EE FF A9 0B .....
0020 20 EE FF A9 0D 20 EE FF .....
0028 A9 F8 B5 71 A9 00 B5 70 ..q..p
0030 B5 7A A9 01 20 EE FF A9 ..z...
0038 1B 20 EE FF A9 01 20 EE .....
0040 FF A9 4B 20 EE FF A9 01 ..K....
0048 20 EE FF A9 40 20 EE FF ...a..
0050 A9 01 20 EE FF 20 EE FF .....
0058 A9 00 B5 72 B5 73 B5 79 ..r..s..y
0060 A5 71 B5 7B A5 7B 18 65 ..q.e.e.e
0068 79 B5 71 A9 00 B5 74 B5 ..y.q...t.
0070 76 B5 75 B5 77 A2 00 A5 ..v.u.w...
0078 74 18 65 70 B5 74 A5 75 ..t.e.p.t.u
0080 65 7A B5 75 E8 E0 04 D0 ..e.z.u...
0088 EE A2 00 A5 76 18 65 71 ...v.e.q
0090 B5 76 A5 77 69 00 B5 77 ..v.w.l..w
0098 E8 E0 04 D0 EE A2 74 A0 .....t.
00A0 00 A9 09 20 F1 FF A5 7B .....x
00A8 F0 0A A4 73 B9 0D 0A 1B .....s...
00B0 65 72 B5 72 E6 79 E6 73 ..e.r.r..y.s
00B8 A5 73 C9 0B D0 A6 A5 7B ..s.....e
00C0 B5 71 A9 01 20 EE FF A5 ..q.....
00C8 72 20 EE FF A5 70 18 69 ..r...p.i
00D0 01 B5 70 A5 7A 69 00 B5 ..p.z...
00D8 7A A5 70 C9 40 F0 03 4C ..z.p..d..L
00E0 58 09 A5 7A C9 01 F0 03 ..X...z...
00E8 4C 58 09 A9 00 B5 70 B5 ..LX...p.
00F0 7A A9 01 20 EE FF A9 0D ..z...
00F8 20 EE FF A5 71 38 E9 08 ...q8..
0100 B5 71 90 03 4C 32 09 A9 ..q..L2..
0108 03 20 EE FF 60 01 02 04 ..'...
0110 0B 10 20 40 80 ** ** ** ..à....
```

```
0000 A0 00 B4 70 B9 00 0A C9 ...p...
0008 0D F0 16 B5 71 38 E9 61 ...q8.a
0010 90 0C A5 71 18 69 B5 B0 ...q.i..
0018 05 B4 70 E6 70 60 C8 D0 ...p.p'..
0020 E3 60 ** ** ** ** ** ** ** ** ** **
```

MSX Chas in the Castle

by A Sidwick

This is a typical platform-and-ladders game for all MSX computers. In it, you take the part of Chas, a likeable short, fat, thief working for a higher authority by stealing toxic spider eggs. Naturally, the spiders protect their eggs and are

extremely poisonous.

To try the game, simply type in the listing, save it and then run it. You can skip the REM statements to save typing and memory.

```
100 REM *****
110 REM *
120 REM * CHAS *
130 REM *
140 REM * IN THE CASTLE. *
150 REM *
160 REM *
170 REM * BY A, SIDWICK *
180 REM *
190 REM * 11/4/85 *
200 REM *
210 REM *****
220 REM
230 REM
240 REM
250 REM
260 REM *** TITLE SCREEN ***
270 REM
280 REM
290 KEYOFF
300 COLOR 11,1,1
310 CLS
320 SCREEN 2,0
330 COLOR 11,1,1
340 OPEN "grp:" FOR OUTPUT AS #1
350 GOSUB 4840
360 PSET (20,30),1
370 PRINT #1," CHAS"
380 COLOR 5
390 PSET (20,37),1
400 PRINT #1,""
410 PSET (20,65),1
420 PRINT #1," IN THE CASTLE"
430 COLOR 11
440 PSET (20,72),1
450 PRINT #1,""
460 REM
470 REM
480 REM *** COPY WRITE SPRITE ***
490 REM
500 REM
510 SPRITE$(1)=CHR$(60)+CHR$(66)+CHR$(189)+CHR$(161)+CHR$(161)+CHR$(189)+CHR$(66)
)+CHR$(60)
520 FOR L=240 TO 40 STEP -1
530 PUT SPRITE 1,(L,48),6,1
540 NEXT L
550 FOR D=48 TO 138 STEP 1
560 PUT SPRITE 1,(40,D),6,1
570 NEXT D
580 FOR R=40 TO 50 STEP 1
590 PUT SPRITE 1,(R,138),6,1
600 NEXT R
610 PSET (70,140),1
620 COLOR 11
```



```

630 PRINT #1,"A.SIDGWICK."
640 PSET(163,140),1
650 COLOR 6
660 PRINT #1,"1985."
670 IF PLAY(2) THEN 670
680 REM
690 REM *****
700 REM
710 REM *** GAME PROGRAM ***
720 REM
730 REM *** STARTS HERE ***
740 REM
750 REM *****
760 REM
770 PSET(32,168),1:COLOR 5:PRINT #1,"Do you want to see the"
780 PSET(32,181),1:PRINT #1,"instructions ? <y/n>"
790 A$=INKEY$:IF A$="" THEN GOTO 790
800 IF A$="Y" OR A$="y" THEN BEEP:GOSUB 5050
805 CLOSE
810 IF A$="N" OR A$="n" THEN BEEP
820 KEY OFF
840 OPEN"GRP:"FOR OUTPUT AS #1
850 COLOR 3,1,1
860 SCREEN 2,2,0
870 REM
880 REM -----
890 REM *** VARIABLES ***
900 REM -----
910 REM
920 SCZ=0
930 MX=30
940 MY=137
950 MS=6
960 L=3
970 FOR I=1 TO 6
980 READ AX(I)
990 NEXT I
1000 DATA 50,100,70,120,10,60
1010 AY=145
1020 AS=3
1030 REM
1040 REM -----
1050 REM ** SET UP SCREEN **
1060 REM -----
1070 REM
1080 GOSUB 3120
1090 REM
1100 REM -----
1110 REM ** DISPLAY SCORE **
1120 REM -----
1130 REM
1140 GOSUB 3880
1150 REM
1160 REM -----
1170 REM ** DISPLAY LIVES **
1180 REM -----
1190 REM
1200 GOSUB 3970
1210 REM
1220 REM -----
1230 REM ** DEFINE SPRITES **
1240 REM -----
1250 REM
1260 REM -----
1270 REM -----
1280 REM ** CHARLIE HERO **
1290 REM -----
1300 REM
1310 REM -----
1320 REM ** STEPPING RIGHT **
1330 REM -----
1340 REM
1350 RESTORE 1430
1360 FOR I=1 TO 16
1370 READ A$
1380 B$=B$+CHR$(VAL ("&B"+LEFT$(A$,B)))
1390 C$=C$+CHR$(VAL ("&B"+RIGHT$(A$,B)))
1400 NEXT I
1410 SPRITE$(1)=B$+C$
1420 REM
1430 DATA 0000000011000000
1440 DATA 0000000111101000
1450 DATA 0000001111110000
1460 DATA 0000011111010000
1470 DATA 0000011000101000
1480 DATA 0000010000100000
1490 DATA 0000001111100000
1500 DATA 0000111111110000
1510 DATA 0001111111111100
1520 DATA 0011101111101110
1530 DATA 0011001111100110
1540 DATA 0000011111000000
1550 DATA 0000111111110000
1560 DATA 0001111001111110
1570 DATA 0011100000111100
1580 DATA 0001110000010000
1590 REM
1600 REM -----
1610 REM -----
1620 REM ** FACING RIGHT **
1630 REM -----
1640 REM
1650 RESTORE 1730
1660 FOR I=1 TO 16
1670 READ D$
1680 E$=E$+CHR$(VAL ("&B"+LEFT$(D$,B)))
1690 F$=F$+CHR$(VAL ("&B"+RIGHT$(D$,B)))
1700 NEXT I
1710 SPRITE$(2)=E$+F$
1720 REM
1730 DATA 0000000110000000
1740 DATA 0000000111101000
1750 DATA 0000001111110000
1760 DATA 0000011110100000
1770 DATA 0000010001010000
1780 DATA 0000010000100000
1790 DATA 0000001111100000
1800 DATA 0000110111100000
1810 DATA 0000011011100000
1820 DATA 0000011011100000
1830 DATA 0000011011100000
1840 DATA 0000001111100000
1850 DATA 0000000111000000
1860 DATA 0000000111000000
1870 DATA 0000000111000000
1880 DATA 0000000111100000

```

SAGE SUPERDEALS

	List Price	Our Price
Sage Accounts	375	245
Sage Plus	695	485
Sage Payroll	195	145
Accts/Payroll	495	359
★ Bookkeeper	295	199
★ Accountant	495	359
★ Accountant Plus	695	485
△ Chit Chat.....	130	110
△ C/C with Modem	395	299
△ Options	145	115.

(★ MS-DOS only △ IBM/Apricot only)

If you require advice please call

All the above prices include full support from our technical department. We are authorised Sage Superdealers.

DEALER ENQUIRIES A MUST

TRISOFT LTD

CROWN SQUARE, MATLOCK,
DERBYSHIRE DE4 3AT
Tel: 0629-3021 (6 lines)

SPECIAL OFFER DISKS

100% ERROR FREE
LIFETIME WARRANTY

89^P EACH
+ VAT SSDD

99^P EACH
+ VAT DSDD

PACKS OF 25 MIN QTY 50
P&P — £1.25 PER PACK

— Kambal Data Systems

01-631 1212

GENIE & TRS-80 Model 1

Don't sell your computer upgrade to latest spec:

Genie 48K RAM **£39.95**

Lowercase Genie **£27.95**

Lowercase TR 80 Mod 1 **CALL**

Hi speed CPU **£27.95** (Nearly double speed)

Centronics printer interface Genie **£44.95**

Centronics Printer TRS Mod 1 **£54.95**

RS232-C interface Genie **£64.95**

R232-C interface TRS Mod 1 **£75.95**

Double density disc upgrade **CALL**

Disc interface **CALL**

Please add £1.50 p&p and 15% VAT

ARC ELECTRONICS
54 HERON DRIVE
WAKEFIELD, W. YORKS
Tel: (0924) 253145

PROGRAM FILE

MICROMART

```

3140 REM
3150 REM *** DRAW FLOORS ***
3160 REM
3170 REM
3180 A=50
3190 FOR N=1 TO 3
3200 FOR W=1 TO 2
3210 Y=W*5+A
3220 FOR B=1 TO 34
3230 X=B*7+3
3240 LINE (X,Y)-STEP (5,3),14,BF
3250 NEXT B
3260 NEXT W
3270 A=A+50
3280 NEXT N
3290 REM
3300 REM
3310 REM ** DRAW STEPS **
3320 REM
3330 REM
3340 LINE (10,38)-(25,44),14,BF
3350 LINE (10,43)-(33,49),14,BF
3360 LINE (10,48)-(41,53),14,BF
3370 REM
3380 REM
3390 REM ** POSITION HOLES **
3400 REM
3410 REM
3420 LINE (102,52)-(119,63),1,BF
3430 LINE (42,102)-(59,113),1,BF
3440 LINE (202,103)-(219,113),1,BF
3450 LINE (152,53)-(169,63),1,BF
3460 REM
3470 REM
3480 REM *** DRAW LADDERS ***
3490 REM
3500 REM
3510 RESTORE 3630
3520 FOR N=1 TO 2
3530 READ T:READ Q:READ F
3540 LINE (T,Q)-(T,Q+F)
3550 LINE (T+10,Q)-(T+10,Q+F)
3560 FOR R=T TO T+10
3570 FOR V=Q+1 TO Q+F STEP 7
3580 LINE (R,V)-(R,V)
3590 NEXT V
3600 NEXT R
3610 BEEP
3620 NEXT N
3630 DATA 138,106,50
3640 DATA 230,56,50
3650 REM
3660 REM
3670 REM ** DRAW BELL **
3680 REM
3690 REM
3700 PSET (15,140),1
3710 DRAW"C10S2R6D2R1U2R8U2L2UBH5L4"
3720 DRAW"65DBL2D2":PAINT (17,139),10
3730 REM
3740 REM
3750 REM ** DRAW SPHERES **
3760 REM
3770 REM
3780 CIRCLE (18,22),5,4:PAINT (19,23),4
3790 CIRCLE (135,38),5,4:PAINT (136,39),4
3800 CIRCLE (25,88),5,4:PAINT (26,89),4
3810 CIRCLE (230,138),5,4:PAINT (232,139),4
3820 RETURN
3830 REM
3840 REM
3850 REM ** DISPLAY SCORE **
3860 REM
3870 REM
3880 LINE (65,0)-(115,8),1,BF
3890 PSET (20,0),1
3900 PRINT #1,"Score ";SC%
3910 RETURN
3920 REM
3930 REM
3940 REM ** DISPLAY LIVES **
3950 REM
3960 REM
3970 LINE (225,0)-(250,8),1,BF
3980 PSET (180,0),1
3990 PRINT #1,"Lives ";L
4000 RETURN
4010 REM
4020 REM
4030 REM ** POSITION ALIENS **
4040 REM
4050 REM
4060 SOUND 7,8B00111110
4070 SOUND 0,2
4080 SOUND 1,15
4090 SOUND 8,5
4100 PUT SPRITE 2,(AX(1),AY),4,5
4110 PUT SPRITE 3,(AX(2),AY),6,5
4120 PUT SPRITE 4,(AX(3),AY-50),15,5
4130 SOUND 7,8B00111110
4140 SOUND 0,7
4150 SOUND 1,25
4160 SOUND 8,5
4170 PUT SPRITE 5,(AX(4),AY-50),11,5
4180 PUT SPRITE 6,(AX(5),AY-100),4,5
4190 PUT SPRITE 7,(AX(6),AY-100),13,5
4200 IF AX(1)<50 THEN AX(1)=240
4210 IF AX(2)<50 THEN AX(2)=240
4220 FOR I=1 TO 6
4230 IF AX(I)<10 THEN AX(I)=240
4240 AX(I)=AX(I)-AS
4250 NEXT I
4260 RETURN
4270 REM
4280 REM
4290 REM *** SUBROUTINE FOR ***
4300 REM *** MOVING CHAS ***
4310 REM
4320 REM
4330 REM
4340 REM *** CHAS GO LEFT ***
4350 REM
4360 REM
4370 MX=MX-MS:PUT SPRITE 1,(MX,MY),11,3:IF MY=37 AND MX<41 AND MX>33 THEN GOSUB
5230
4380 IF MX<10 THEN MX=10

```

PLUS 5

HIGH QUALITY AT A LOW PRICE

Example prices for IBM/Olivetti, Ericsson, Apricot and Sirius

FIXED PRICE SUBSYSTEMS

10MB.....RRP £1,295 Our Price £1,075
40MB.....RRP £2,395 Our Price £1,995

FIXED/REMOVABLE SUBSYSTEMS

10 + 5MB RRP £2,545 Our Price £2,095
40 + 5MB RRP £3,645 Our Price £2,995

RAM BOARDS FOR APRICOT

128K.....£145
256K.....£209
512K.....£425

All prices are exclusive of carriage and VAT

TRISOFT LTD

Crown Square, Matlock, Derbyshire DE4 3AT
Telephone: 0629 3021 (6 lines)

LOWEST PRICES IN U.K?

MICROS	PRINTERS
Sinclair Spectrum 48K, free software 6 pack£74	Commodore MPS 801£139
Sinclair Spectrum Plus, free software 6 pack£105	Commodore MPS 802, Free Easy script & Future Finance£265
Sinclair QL£322	Commodore DPS 1101, Free Easy script£338
Commodore 64 Business Pack, Computer, disc drive, printer, software£473	Epson RX 80FT4£231
Commodore 64 Pack, Cassette player, Int Soccer, Free holiday voucher for two£170	Canon PW 1050A£299
Amstrad CPC 464, Colour monitor & over £100 software£291	Shinwa CP4 80£196
Amstrad CPM 464, Green monitor & over £100 software£294	Brother EP44£208
Amstrad CPC 664, Green monitor£283	Brother M1009£170
Amstrad CPC 664, Amber monitor£370	Brother HRS£130
BBC B (Econet fitted)£387	Juki 2200£295
Sanyo MSX£199	
MONITORS	ACCESSORIES
Sinclair QL vision monitor£252	ZX Expansion system: Microdrive, Interface & software£86
Microvitec QL monitor£235	Spectrum disc drive interface£87
Psion QL 14£189	DK Tronics light pen£17
Commodore colour monitor£174	Sinclair interface 2 (tree Rom)£17
Fidelity TV monitor£192	Program joystick interface£20
Sanyo green monitor£82	Quick Shot II joystick£3
DISK DRIVES	Easy Script£40
Commodore 1541, Free Easy script£162	Diskettes 3M SS DD 10£17
Amstrad 3"£169	Microdrive Cartridge£1.73
Cumana CSX 100£104	CASIO
Cumana CSX 200S£134	FX700£108
Cumana CD 800S£347	FX820P£83
	FX750P£75
	FX720P£42
	FX4000P£34
	P6410£42
	P6110£33
	Data Bank PF3100£34

Complete range of Casio and Spectrum/Commodore add ons at discount prices. Prices/Goods subject to availability and change without notice. All prices exclude VAT, P&P (S within UK)
Trade and Export enquiries welcome



K. K. STATIONERS



187 Edgware Road
Marble Arch
London W2 1ET
Tel: 01-723 1436

126 Edgware Road
Marble Arch
London W2 2DZ
Tel: 01-402 4592

172 Queensway
Queensway
London W2
Tel: 01-229 3247

SCIENTIFIC SUBROUTINE LIBRARY

VOLUME 1 — STATISTICS AND CURVE FITTING

Mean, SD, Normal Distribution, Partial Expectation, Chauvenets Criterion, Least Squares Fit to a Polynomial and Arbitrary Function, Repetitive Least Squares Fits, Covariance Matrix, Chi-Squared Statistic, Matrix Inversion, Solution of Linear Simultaneous Equations.

VOLUME 2 — LINEAR PROGRAMMING

Reduction of a Simplex Tableau, Integer Programming, Partial Integer Programming, Conversational Linear Programming System, Least Cost Mix Problem.

VOLUME 3 — FURTHER STATISTICS

Ranking, Quantiles, Frequency, Correlation Coefficient, T, Chi-Squared and F Distributions and their Inverses, T Test, Chi-Squared Test, Wilcoxon Test, Linear and Multiple Regression, ANOVA 1-way and 2-way.

VOLUME 4 — TRANSFORMATIONS AND SORTING ALGORITHMS

Fourier and Fast Fourier Transforms, Numerical Integration and Differentiation, Harmonic Analysis, Interpolation, Coordinate Transformations, Exchange Sort, Quicksort, Shellsort, Tree Sort.
All routines are written in BASIC for easy implementation on any machine. Machine readable source code — £75 plus VAT per volume. (Most disk formats plus QL microdrive now available).
Manuals including full source listings with implementation notes and documentation — £25 per volume.

CP/M TO DEC FILE TRANSFER

Software to read and write RT-11 format RX01 diskettes under CP/M80. Supplied on 8" SSDD diskette — £25 plus VAT.

SERVICES

Micro Logic Consultants specialise in scientific data processing and the interfacing and control of laboratory instrumentation. We can advise you on the best approach to your problem, or provide a complete solution. Contact Derek Clifford on 0860 319482.

MICRO LOGIC CONSULTANTS LTD

57 Station Road, Southwater, Horsham
W. Sussex RH13 7HQ
Telephone: 0403 731818

FLOPPIES

Superb "Own-Label" Disks
(5yr Warranty)

Plus the FUJI FILM range
Defining the Standards for
Floppy Disks

5.25" Disks	"Own-Label"		Fuji Film	
	10	100	10	100
SSDD (40tr)	£9.95	95.00	13.25	127.50
DSDD (40tr)	£10.95	105.00	18.75	181.50
SSQD (80tr)	£13.95	135.00	n/a	n/a
DSQD (80tr)	£14.95	145.00	22.60	218.00
MD2HD-256 1.6Mb			27.75	266.67

BULK PACKS 200 Unlabelled Disks & Sleeves
SSDD £178.00 DSDD £198.00 DSQD £288.30

3.50" DISKS —

THE CHEAPEST MICROFLOPPIES YET
"OWN-LABEL" FUJI FILM SONY D3/4-440
10 100 10 100 10 100
25.75 240.00 26.10 252.00 28.00 260.00

FREE SOFTWARE!!!

IBM-PC™ and Compatibles

300 DISKS FULL OF FREE PROGRAMS

The contents of the Santa Clara and New York
PC User Group Libraries

Games, Utilities and Business Software

	Buy	Rent
All 300	£450.00	£222.00
Vols 1-100	£150.00	£75.00
Vols 101-200	£150.00	£75.00
Vols 201-300+	£150.00	£75.00

Disk rentals are for 14 days and include return
carriage and 20% blank disks, ie includes +60
blanks on Full Library

ALL PRICES EX-VAT but include delivery (UK).
COD or 3% CWO discount

MID-SURREY MEDIA

Unit G22, Southbank Technopark
London Road, Elephant & Castle
London SE1 6LN

Tel: 01-928 2900

IBM is the trademark of International Business Machines

BANK ACCOUNT FOR THE

QL

Fed up with infrequent bank statements? Avoid
bank charges and keep up to date with BANK
ACCOUNT. Check your mortgage, HP, standing
orders! Budget those bills.

- * Automatic posting of standing orders and other regular payments or credits.
- * Delete, amend and even backdate entries. Scroll through your statements. Comprehensive 80 column display and printout.
- * 6 different entry search routines!
- * Post items to headings name by YOU to suit your circumstances. Print out individual accounts and summary, e.g. all payments to building society or motoring expenses.
- * Output of bank statement and accounts to most Epson compatible printers. Makes automatic use of memory expansions. Demonstration bank account included.

Cartridge and Manual £19.95 + 50p P&P

Cheques and POs to:

CENPRIME SOFTWARE
Dept. PCW
10 CASTLE STREET
RUGBY CV21 2TP
Tel: Coventry (0203) 686162

```

4390 RETURN
4400 REM
4410 REM -----
4420 REM *** CHAS GO RIGHT ***
4430 REM
4440 REM
4450 MX=MX+MS:PUT SPRITE 1,(MX,MY),11,2:IF MY=19 THEN GOSUB 5340
4460 IF MX>230 THEN MX=230
4470 RETURN
4480 REM
4490 REM -----
4500 REM *** CHAS GO UP ***
4510 REM
4520 REM
4530 IF MY=137 AND MX>131 AND MX<145 THEN MY=87
4540 IF MY=87 AND MX>223 AND MX<237 THEN MY=37
4550 PUT SPRITE 1,(MX,MY),11,3
4560 RETURN
4570 REM
4580 REM -----
4590 REM *** CHAS GO DOWN ***
4600 REM
4610 REM
4620 IF MY=37 AND MX>223 AND MX<237 THEN MY=87
4630 IF MY=87 AND MX>131 AND MX<145 THEN MY=137
4640 PUT SPRITE 1,(MX,MY),11,2
4650 RETURN
4660 REM
4670 REM -----
4680 REM ** LOOSE LIFE ROUTINE **
4690 REM
4700 REM
4710 SOUND 8,0
4720 MX=30:MY=137:PUT SPRITE 1,(MX,MY),11,2
4730 PLAY"125V804BAGFE8D8C8","04GFEDC803B8A8","04EDC03B8A8F8"
4740 L=L+1
4750 GOSUB 3970
4760 IF L<1 THEN GOSUB 4930
4770 FOR X=1 TO 600:NEXT X
4780 RETURN
4790 REM
4800 REM -----
4810 REM ** TITLE MUSIC ROUTINE **
4820 REM
4830 REM
4840 A1$="03T120E8D8C4E8F8G4A8B8D4C403B8A8G8A8G8F8E4D8C3"
4850 A2$="03T120G8F8E4G8A8B4D4C8D8E4D8C8D3B8D4C8D3B8A8G4F8E3"
4860 PLAY A1$,A2$
4870 RETURN
4880 REM
4890 REM -----
4900 REM *** LOOSER SCREEN ***
4910 REM
4920 REM
4930 SCREEN 0
4940 PRINT"You lose... you have scored ";SC%
4950 LOCATE 0,21:PRINT"Do you want to play again <Y/N> ?"
4960 A$=INKEY$
4970 IF A$="N" OR A$="n" THEN CLS:PRINT"SO LONG FOR NOW.";END
4980 IF A$="Y" OR A$="y" THEN CLEAR:GOTO 840
4990 GOTO 4960
5000 REM
5010 REM -----
5020 REM *** INSTRUCTIONS ***
5030 REM
5040 REM
5050 SCREEN 0:COLOR 4,1
5060 PRINT".1. INSTRUCTIONS"
5070 LOCATE 3,4:PRINT"Use the CURSOR keys to move Chas around the screen."
5080 LOCATE 3,8:PRINT"You must help Chas prove he is not as yellow as he looks by
helping him destroy the giant blue radio-active spider eggs."
5090 LOCATE 3,14:PRINT"Jump over the spiders, which try to protect the eggs, by
pressing the SPACE BAR."
5100 LOCATE 3,20:PRINT"PRESS ANY KEY TO CONTINUE."
5110 IF INKEY$="" THEN 5110
5120 CLS
5130 PRINT".2. INSTRUCTIONS"
5140 LOCATE 3,10:PRINT"After you have helped him destroy all the eggs on the scr
een return to the bottom level, ding the bell and more eggs will appear."
5150 LOCATE 3,20:PRINT"PRESS ANY KEY TO CONTINUE."
5160 IF INKEY$="" THEN 5160
5170 RETURN
5180 REM
5190 REM -----
5200 REM ** GO UP STAIRS **
5210 REM
5220 REM
5230 SPRITE STOP
5240 FOR SU=1 TO 3
5250 MY=MY-6
5260 GOSUB 6210
5270 MX=MX-7
5280 NEXT SU
5290 SPRITE ON
5300 RETURN
5310 REM
5320 REM ** GO DOWN STAIRS **
5330 REM
5340 SPRITE STOP
5350 FOR D=1 TO 3
5360 MX=MX+7
5370 GOSUB 6230
5380 MY=MY+6
5390 NEXT D
5400 SPRITE ON
5410 RETURN
5420 REM
5430 REM ** JUMP OVER GAP **
5440 REM
5450 REM
5460 IF MY=87 AND MX>25 AND MX<35 THEN GOSUB 5820:RETURN
5470 IF MY=87 AND MX>185 AND MX<195 THEN GOSUB 5820:RETURN
5480 IF MY=37 AND MX>85 AND MX<95 THEN GOSUB 5820:RETURN
5490 IF MY=37 AND MX>135 AND MX<145 THEN GOSUB 5820:RETURN
5500 IF MY=87 AND MX>50 AND MX<60 THEN GOSUB 6040:RETURN
5510 IF MY=87 AND MX>210 AND MX<220 THEN GOSUB 6040:RETURN
5520 IF MY=37 AND MX>110 AND MX<120 THEN GOSUB 6040:RETURN
5530 IF MY=37 AND MX>160 AND MX<170 THEN GOSUB 6040:RETURN
5540 REM
5550 REM -----
5560 REM ** JUMP OVER SPIDERS **
5570 REM
5580 REM
5590 SPRITE STOP
5600 FOR UP=1 TO 6
5610 MY=MY-3

```

PROGRAM FILE

MICROMART

```

5620 GOSUB 6230
5630 GOSUB 4060
5640 NEXT UP
5650 FOR D=1 TO 6
5660 MY=MY+3
5670 GOSUB 6230
5680 GOSUB 4060
5690 NEXT D
5700 SPRITE ON
5710 RETURN
5720 REM
5730 REM
5740 REM ** JUMP GAP ROUTINE **
5750 REM
5760 REM
5770 REM
5780 REM
5790 REM ** JUMP TO RIGHT **
5800 REM
5810 REM
5820 MY=MY-6
5830 GOSUB 6230
5840 MX=MX+8
5850 GOSUB 6230
5860 MY=MY-6
5870 GOSUB 6230
5880 MX=MX+8
5890 GOSUB 6230
5900 MX=MX+8
5910 GOSUB 6230
5920 MY=MY+6
5930 GOSUB 6230
5940 MX=MX+8
5950 GOSUB 6230
5960 MY=MY+6
5970 GOSUB 6230
5980 RETURN
5990 REM
6000 REM
6010 REM ** JUMP TO LEFT **
6020 REM
6030 REM
6040 MY=MY-6
6050 GOSUB 6210
6060 MX=MX-8
6070 GOSUB 6210
6080 MY=MY-6
6090 GOSUB 6210
6100 MX=MX-8
6110 GOSUB 6210
6120 MX=MX-8
6130 GOSUB 6210
6140 MY=MY+6
6150 GOSUB 6210
6160 MX=MX-8
6170 GOSUB 6210
6180 MY=MY+6
6190 GOSUB 6210
6200 RETURN
6210 PUT SPRITE 1, (MX,MY),11,3
6220 RETURN
6230 PUT SPRITE 1, (MX,MY),11,2
6240 RETURN
6250 REM
6260 REM
6270 REM * YOU'VE BEEN VAPOURISED *
6280 REM
6290 REM
6300 PUT SPRITE 1, (MX,MY),4,3
6310 FOR X=1 TO 60:NEXT X
6320 PUT SPRITE 1, (MX,MY),15,3
6330 FOR X=1 TO 50:NEXT X
6340 PUT SPRITE 1, (MX,MY),11,3
6350 FOR X=1 TO 60:NEXT X
6360 PUT SPRITE 1, (MX,MY),15,3
6370 FOR X=1 TO 50:NEXT X
6380 PUT SPRITE 1, (MX,MY),6,3
6390 FOR X=1 TO 50:NEXT X
6400 PUT SPRITE 1, (MX,MY),15,3
6410 FOR X=1 TO 50:NEXT X
6420 PUT SPRITE 1, (MX,MY),13,3
6430 GOSUB 4710
6440 RETURN
    
```

DISKS

SONY 3½ SSDD	£29.95
SONY 3½ DSDD	£39.95
DYSAN 5¼ SSDD	£18.95
DYSAN 5¼ DSDD	£23.45
DYSAN 5¼ DSQD	£28.95
3M 5¼ DSDD	£19.95
PARROT 5¼ DSDD	£18.95

Prices are per box of 10

**PLEASE ADD £1 CARRIAGE
AND VAT**

TriSoft Ltd

CROWN SQUARE, MATLOCK
DERBYSHIRE DE4 3AT

Tel: 0629 3021

BARGAIN PRICES

e.g.:

Olivetti M24, 8086 processor, 360K floppy drive, graphics screen, keyboard, graphics, 640K RAM, 10 Mb Hard disk, serial, parallel ports, 7 IBM Compatible expansion slots. List price:

£3784, plus VAT

Our price:

£2700, plus VAT

Also call for printer and licensed software prices. Free software deals are open to all our customers. Delivery anywhere in UK.

**DON'T MISS IT CALL
(0342) 28528 NOW**



QL Memoire by AWH Perkins

This is a memory game for two players using joysticks or cursor keys. A 'board' consisting of 10 x 9 blocks is set up, representing 45 pairs of picture cards. You take turns to turn up two cards, keep them if they match, and then get another turn. At the end of the game, the player with most cards wins.

It is recommended that you play the game using joysticks. If you use the keyboard, then press the space bar to select a card. Turns are indicated by a red or blue joystick on either side of the screen.

```

100 REMark QL Memoire By A W H Perkins
110 REMark A "text-less" Memory Game...
120 REMark Should run in TV & Monitor Modes...
130 REMark Containing 45 different, full colour pictures!
140 REMark Version 1.0
150 MODE 8:RANDOMISE RND(1TO 10000)
160 WINDOW 512,256,0,0:PAPER 0:CLS
170 WINDOW 320,185,95,0:BORDER 1,7:INK 7
180 WINDOW#2,320,185,95,0:PAPER#2,0:INK#2,7:BORDER#2,1,7
190 OPEN#4,con_320x70a95x185:PAPER#4,0:INK#4,7:CLS#4
200 OPEN#5,con_68x68a145x187:SCALE#5,68,0,0
210 OPEN#6,con_68x68a285x187:SCALE#6,68,0,0
220 OPEN#7,con_60x255a33x0:PAPER#7,0:CLS#7:SCALE#7,255,0,0:OVER#7,-1
230 OPEN#8,con_60x255a416x0:PAPER#8,0:CLS#8:SCALE#8,255,0,0:OVER#8,-1
    
```

THE NEWBRAIN FILES

A completely new book all about the NewBrain & its graphics & the 25 device drivers & all 80 operating system Z-calls with their parameters & how to get them & the most from the BASIC & how the paged memory works & CP/M's BIOS & why VIDEOTEXT & all the other things they never told you before plus lots of routines & examples & a text-handler & a database & smart graphics & details of key memory locations & what's there & how to read it & change it.

**The NewBrain Files
£9.50 incl. UK p&p**

Europe: £10 or \$12 US by Eurocheque or equivalent in local bank notes.
Elsewhere: £12 or \$15 US by Eurocheque or equivalent in convertible local banknotes.
If you pay by cheque in foreign currency at your local bank please add the equivalent of \$2 to pay the rip-off bank exchange charges.
136 pages A5 size ISBN 0 948152 00 1 (c) 1985 Vitagraph Ltd.

**Vitagraph Ltd
26 College Road
Bromley, Kent
BR1 3PE**

Faster BASIC

The BASIC Tuning Kit is a diagnostic tool which allows you to monitor and improve the speed of interpreted IBM BASIC programs on the IBM PC.

The report it produces contains a histogram of those line numbers of your BASIC program which are consuming most CPU time. You can then re-write these highlighted lines, making them more efficient and thus improve the overall performance of your software.

The BASIC Tuning Kit is £49.45 inclusive.

C Tools - call for data sheets.

Figure Flow Ltd

9 Market Place, Hadleigh,
Suffolk IP7 5DL

Tel: 0473 822917

UPDATE

ADD A DISK DRIVE FACILITY
TO YOUR CASSETTE SYSTEM
AMSTRAD 464

MAGIC PEN: By itself, probably the ultimate ART utility. Save to tape — supplied with loader sketch, or filled, £4.95. **SYMBOL 464:** Design your own lettering, copy pictures from anywhere or original. Save to tape plus decimal print-out, £3.95. **BIG LETTERS:** By itself it's good, with the above, fantastic. Big lettering to 224 pixels. Save to tape, £2.95. **PAINT 464:** Add the fill function. Full or alternative line, plus program subroutine supplied, £3.50. **MOVE IT:** Move the files produced around with this handy utility, £2.50. **THE ARTISTS EASEL:** Now with airbrush + screen dump facility: A collection of integrated graphic functions and subroutines, "25" options plus MAGIC PEN, plus SYMBOL 464, plus BIG LETTERS, plus PAINT 464, plus MOVE IT with handbook. The complete collection: £9.95

All price inc. p&p.
Export enquiries welcome

BINARY BANANA
c/o Pitec Ltd, Park Crescent,
Peterborough PE1 4BG

EPSON

TOP QUALITY PRINTERS AT
ROCK BOTTOM PRICES

EPSON RX 80 FT £228
EPSON FX 80 £328
EPSON RX 100 £350
EPSON FX 100 £465
JUKI 2200 Parallel or Series £264

Also available: Large stocks of Sundries including Ribbons, Fanfold and Roll Paper, Continuous Labels, Dust Covers etc.

FREE Brochure and Discount Order Forms.

DATATECH LTD (PCW)
8 BELLINGHAM CLOSE
BURY
LANCS BL8 2TU
Tel: 061-764 5579

```

240 udg: DIM gr(10,9),ca(45),pik(2),sc(2):play=2
250 FOR f=1TO 45:ca(f)=0
260 REPEAT Loop1
270 xx=RND(1TO 10):yy=RND(1TO 9)
280 IF gr(xx,yy)<>0:GO TO 270
290 rr=RND(1TO 45):ca(rr)=ca(rr)+1:IF ca(rr)>2:GO TO 290
300 gr(xx,yy)=rr
310 FOR k=1TO 45
320 IF ca(k)>=2:NEXT k:EXIT Loop1
330 k=45
340 END REPEAT Loop1
350 fill:sc(1)=0:sc(2)=0
360 stick(7)
370 REPEAT main_loop
380 play=(NOT(play-1))+1:xxx=0:yyy=0
390 FOR pick=1TO 2
400 OVER -1:CURSOR 0,0:CSIZE 1,1:x%=1:y%=1:CURSOR (x%-1)*32+9,(y%-1)*20
410 PRINT CHR$(33)
420 k%=KEYROW(1)
430 IF k%=0:NEXT s_loop
440 CURSOR (x%-1)*32+9,(y%-1)*20+2:PRINT CHR$(33)
450 IF k%&&2:x%=x%-1
460 IF k%&&4:y%=y%-1
470 IF k%&&16:x%=x%+1
480 IF k%&&128:y%=y%+1
490 IF x%>10:x%=10
500 IF x%<1:x%=1
510 IF y%>9:y%=9
520 IF y%<1:y%=1
530 IF k%&&64
540 IF gr(x%,y%)=ODR (xxx=x% AND yyy=y%):BEEP 10000,1000:GO TO 560:ELSE
EXIT s_loop
550 END IF
560 CURSOR (x%-1)*32+9,(y%-1)*20+2:PRINT CHR$(33)
570 END REPEAT s_loop
580 OVER 0:BLOCK 27,15,(x%-1)*32+3,(y%-1)*20+3,0
590 card pick+4,gr(x%,y%):pik(pick)=gr(x%,y%):IF pick=1:xxx=x%:yyy=y%
600 NEXT pick
610 IF pik(1)=pik(2)
620 gr(xxx,yyy)=0:gr(x%,y%)=0
630 sc(play)=sc(play)+2:OVER#(play+6),0
640 FOR k=1TO sc(play)
650 INK#(play+6),(k MOD 2)+1:LINE#(play+6),0,(k-1)*2TO 50,(k-1)*2
660 NEXT k:OVER#(play+6),-1
670 IF sc(1)+sc(2)=90:end_game
680 play=(NOT(play-1))+1
690 END IF
700 FOR kk=1TO 2000:NEXT kk
710 FOR kk=1TO 160:SCROLL#4,1
720 fill
730 IF pik(1)=pik(2):GO TO 750
740 stick(7):stick(8)
750 END REPEAT main_loop
760 DEFine PROCEDURE fill
770 FILL 0:FOR aa=1TO 10
780 FOR bb=1TO 9
790 IF gr(aa,bb)=0:BLOCK 27,15,(aa-1)*32+3,(bb-1)*20+3,0:GO TO 810
800 BLOCK 27,15,(aa-1)*32+3,(bb-1)*20+3,1,2
810 NEXT bb:NEXT aa
820 END DEFine fill
830 DEFine PROCEDURE udg
840 ob=PEEK_L(167722):nb=RESPR(875)
850 FOR m=0TO 875STEP 4
860 POKE_L nb+m,PEEK_L(ob+m):NEXT m
870 POKE_L 167722,nb:RESTORE 900
880 READ a:cb=nb+10+(a-32)*9
890 FOR d=1TO 9:READ e:POKE cb+d,e
900 DATA 33,124,68,68,84,68,68,124,0,0,0
910 END DEFine udg
920 DEFine PROCEDURE end_game
930 stick(play+6)
940 IF sc(1)<sc(2):ss=sc(1):c=8:ELSE ss=sc(2):c=7
950 ss=ss*2:IF ss<=0:GO TO 970
960 FOR k=1TO ss:SCROLL#7,1:SCROLL#8,1
970 flag(c)
980 CSIZE 0,1:AT 5,0:PRINT"Enter for another game ..."
990 INPUT i$:IF RND>.5:RUN:ELSE RANDOMISE RND(1TO 4000):RUN
1000 END DEFine end_game
1010 DEFine PROCEDURE flag(v)
1020 IF v=7:v=137482:ELSE v=137578
1030 RESTORE 1100
1040 FOR k=0TO 12
1050 FOR j=0TO 11
1060 READ a
1070 POKE (j+(k*128)+v),a
1080 NEXT j:NEXT k
1090 v=v-257:FOR k=0TO 45:POKE (k*128)+v,15:POKE (k*128)=128,0:NEXT k
1100 DATA 32,181,0,85,128,232,0,0,0,0,0,8,173,0,85,130,235,0,0,0,0,0,0,0
1110 DATA 0,106,128,213,130,235,0,64,0,0,0,0,86,8,173,136,237,0,64,0,0,0,0
1120 DATA 0,170,0,170,128,229,0,0,0,0,0,0,85,160,250,32,180,0,0,0,0,0,0,0
1130 DATA 8,94,8,173,8,173,0,85,128,233,0,85,130,235,0,85,2,168,8,94,32,181,0,80
1140 DATA 0,0,0,0,32,202,0,168,0,85,0,0,0,0,0,2,32,182,0,170,0,168,0,0
1150 DATA 0,0,0,2,32,211,32,122,128,229,0,0,0,0,0,8,94,2,87,2,171,0,8,0
1160 DATA 0,0,0,0,2,43,0,85,32,122,128,229
1170 END DEFine flag
1180 DEFine PROCEDURE stick(z)
1190 INK#z,(z-6):LINE#z,2,226TO 2,222TO 40,222TO 40,228:ARC#z,40,226TO 32,231,2:LINE#z,32,231TO 10,231:ARC#z,2,226TO 10,231,-2
1200 LINE#z,15,232TO 24,255TO 31,255TO 26,232
1210 INK#z,z-3
1220 END DEFine stick
1230 DEFine PROCEDURE card(ch,cc)
1240 INK#ch,7:FILL#ch,0

```

PROGRAM FILE

MICROMART



BETTER SERVICE, BETTER PRICES, WIDER CHOICE

COMPUTERS SANYO (now including IBM compatible and 2x800K versions), APRICOT & OLIVETTI, plus WIDEST CHOICE of IBM COMPATIBLES. Tailored systems from under £1,000.
PLUS NETWORK SYSTEM for any combination of these computers (up to 64) at £250 per station, PLUS Free on-site warranty. Hard disk systems, extra RAM (eg Apricot 128K £139). Multifunction boards etc. all at discount prices.

SOFTWARE Full range of WP, spreadsheet and database software etc, plus Accounts, Payroll, CAD, Communications packages etc. All at very special prices — eg Wordstar 2000 £299, Sage Accounts £249, Supercalc II £145.

PRINTERS All the leading printers supplied. We specialise in Near Letter Quality Matrix Printers (from under £200) and Daisywheels.

PLOTTERS We supply a full range of plotters from A4 — £169 (MCP80 and Silver-Reed EB50), A3 — £275 (ROLAND), A1 — £2,995 (HOUSTON). Use independently or as part of a CAD system.

PRINTER BUFFERS Serial/parallel in or out. 8K-512K, eg from 8K — £75, 16K — £85, 32K — £95, 64K — £119.

THIS MONTH'S SPECIAL OFFERS!

- * Shinwa CPA 80 £175 *
- * Epson LX80 (NLQ) NEW! £209
- * Kaga Taxan KP810 (NLQ) £239 *
- * 18cps QUME compatible daisywheel £199
- * Brother HR15 daisywheel £319 *

Boxed in 10s	DYSAN 100% guaranteed Per box + per order	3M Lifetime guarantee Per box + per order
SSDD	£14.40 + £1.00	£11.75 + £2.75
DSDD	£20.90 + £1.45	£16.25 + £2.75
SSOD	£20.90 + £1.45	£17.15 + £3.85
DSOD	£26.85 + £1.65	£20.15 + £3.85

SONY 3.5" AMSTRAD 3"

SS	£26.50 + £3.30	£32.50 per box of 10
DS	£36.50 + £3.30	

VOLUME DISCOUNTS. TOP QUALITY UNLABELLED DISKS EVEN LOWER PRICES

Please add £2.00 to the above prices if required in "SEE 10" Library Case

UNLABELLED DISKS from the above manufacturers at EVEN LOWER PRICES

FANFOLD PAPER 11" x 9.5" £9.75. A4 Clean Edge £11.69 2,000 sheets/box. All sizes available. Delivery £2.25 (fixed) + £1 per box. LABELS from £1.70 per 1000.

RIBBONS — All types available at low prices, eg Juki 6100 99p, Shinwa CP/CPA 80 £3.79, Epson FX/MX/RX 80 £2.49, Qume MS £2.65, Kaga/Canon £5.25

PRINTWHEELS from £3.79. Delivery 95p (any quantity ribbons/printwheels).
Official Government/Educational/Local Authority orders welcomed
Please add 15% VAT to all prices (inc carriage). Limited space precludes listing of our full range of products. Please telephone if you do not see the item you require.

A.M.A COMPUTER SYSTEMS & SUPPLIES
Dept A, 8 Glebe Street, Beeston
NOTTINGHAM NG9 1BZ
Tel: (0602) 255415

IS YOUR IBM PC SECURE?



Are your PERSONAL computer files becoming COMMON knowledge? Encode your files with "CRYPTO" — THE file encrypting program. Mathematically secure even from larger computers. Out now only £29.

CRYPTO — Data Cipher..... £29

Also available:

TEA — Integrated ideas and word processor..... £99

LDA — Logic Design Aid..... £49

Logitech
(01)-794 5441

310 Finchley Rd, Hampstead, LONDON NW3

```

1250 SELECT ON cc
1260 =1:RESTORE 1560:=2:RESTORE 1610:=3:RESTORE 1630:=4:RESTORE 1670
1270 =5:RESTORE 1710:=6:RESTORE 1730:=7:RESTORE 1760:=8:RESTORE 1780
1280 =9:RESTORE 1810:=10:RESTORE 1830:=11:RESTORE 1860:=12:RESTORE 1880
1290 =13:Memoire:GO TO 1510:=14:RESTORE 1970:=15:RESTORE 2000:=16:RESTO
RE 2020
1300 =17:RESTORE 2040:=18:RESTORE 2060:=19:RESTORE 2080:=20:RESTORE 210
0
1310 =21:RESTORE 2120:=22:RESTORE 2140:=23:RESTORE 2160:=24:RESTORE 219
0
1320 =25:RESTORE 2210:=26:RESTORE 2230:=27:RESTORE 2260:=28:RESTORE 228
0
1330 =29:RESTORE 2300:=30:RESTORE 2320:=31:RESTORE 2350:=32:RESTORE 237
0
1340 =33:RESTORE 2390:=34:RESTORE 2410:=35:RESTORE 2430:=36:RESTORE 245
0
1350 =37:RESTORE 2470:=38:RESTORE 2500:=39:RESTORE 2520:=40:RESTORE 254
0
1360 =41:CLEF:GO TO 1510:=42:RESTORE 2650:=43:RESTORE 2670:=44:RESTORE
2700:=45:pass:GO TO 1510
1370 END SElect
1380 REPeat loop
1390 READ a:IF a=8:FILL#ch,1:NEXT loop
1400 IF a=11:READ b,c,d,e,f:CIRCLE#ch,b,c,d,e,f:NEXT loop
1410 IF a=88:FILL#ch,0:NEXT loop
1420 IF a=999:EXIT loop
1430 READ b,c,d,e
1440 IF a=9
1450 INK#ch,b:POINT#ch,c,d:NEXT loop
1460 END IF
1470 IF a=10:READ f:ARC#ch,b,c TO d,e,f:NEXT loop
1480 INK#ch,a:LINE#ch,b,c TO d,e
1490 END REPeat loop
1500 IF cc=1:INK#ch,3:CURSOR#ch,10,8:PRINT#ch,"CHAD"
1510 BORDER#ch,1,1:BORDER#ch:PAPER#ch,0
1520 IF cc=44:RECOL#ch,1,2,3,4,5,6,7,0
1530 END DEFine card
1540 REMark DATA for pictures...
1550 REMark Chad
1560 DATA 8,2,0,0,50,0,2,50,0,50,25,2,50,25,0,25,2,0,25,0,0,88,7,0,0,50
,0,7,0,5,50,5,7,0,10,50,10,7,0,15,50,15,7,0,20,50,20,7,0,25,50,25
1570 DATA 7,0,0,0,25,7,50,0,50,25,7,40,0,40,5,7,30,0,30,5,7,20,0,20,5,7
,10,0,10,5,7,5,5,10,7,15,5,15,10,7,25,5,25,10,7,35,5,35,10,7,45,5,45,
10
1580 DATA 7,10,10,10,15,7,20,10,20,15,7,30,10,30,15,7,40,10,40,15,7,5,1
5,5,20,7,15,15,15,20,7,25,15,25,20,7,35,15,35,20,7,45,15,45,20,7,10,20
,10,25,7,20,20,20,25,7,30,20,30,25,7,40,20,40,25
1590 DATA 2,15,26,15,31,2,35,26,35,30,10,15,30,35,30,-3.142,8,0,21,25,2
1,19,10,21,19,29,19,3.142,0,29,19,29,25,0,29,25,21,25,88,9,5,20,32,0,9,
5,30,32,0,999
1600 REMark Red Cross
1610 DATA 8,7,0,20,50,20,7,50,20,50,50,7,50,50,0,50,7,0,50,0,20,8,2,22,
20,27,20,2,27,20,27,50,2,27,50,22,50,2,22,50,22,20,8,2,0,32,50,32,2,50,
32,50,37,2,50,37,0,37,2,0,37,0,32,88,999
1620 REMark Tank
1630 DATA 8,4,15,40,32,40,4,32,40,32,37,4,32,37,35,37,4,35,37,35,32,4,3
5,32,32,32,4,32,32,32,4,32,30,15,30,4,15,30,15,32,4,15,32,12,32,4,12
,32,12,37,4,12,37,15,37,4,17,37,15,40,88
1640 DATA 5,35,35,50,35,4,5,29,0,26,4,0,20,4,0,20,5,16,4,5,16,5,21
,4,5,21,45,21,4,45,21,45,16,4,45,16,50,20,4,50,20,50,26,4,50,26,45,29,4
,45,29,5,29
1650 DATA 4,10,19,40,19,4,42,18,42,15,4,40,14,10,14,4,8,15,8,18,2,12,16
,38,16,999
1660 REMark Harry
1670 DATA 8,6,15,52,15,62,6,15,63,18,68,6,18,68,32,68,6,32,68,35,62,6,3
5,62,35,52,6,35,52,43,52,6,43,52,43,50,6,43,50,7,50,6,7,50,7,52,6,7,52,
15,52,6,15,52,15,63,8,6,16,48,25,48,6,25,48,25,45,6,25,45,33,45,6,33,45
,33,40
1680 DATA 6,33,40,30,36,6,30,36,20,36,6,20,36,16,40,6,16,40,16,48,8,6,1
2,32,17,35,6,17,35,6,17,35,6,27,35,37,30,6,37,30,37,15,6,37,15,30,10,6,30
,10,18,10,6,18,10,12,15,6,12,15,12,32
1690 DATA 8,0,20,28,17,22,0,17,22,23,15,0,23,15,26,17,0,26,17,21,29,0,2
1,24,20,28,88,0,23,27,20,21,999
1700 REMark GL
1710 DATA 7,5,10,5,55,7,5,55,20,55,7,20,55,20,10,7,20,10,5,10,8,7,25,5,
20,5,7,20,5,12,18,7,12,18,15,14,7,15,14,25,5,88,7,28,55,28,10,7,28,10,4
0,10,999
1720 REMark House
1730 DATA 8,4,0,0,50,0,4,50,0,50,20,4,50,20,0,20,4,0,20,0,0,8,1,50,20,5
0,68,1,50,68,0,68,1,0,68,0,20,1,0,20,50,20,8,7,10,5,40,5,7,40,5,40,30,7
,40,30,10,30,7,10,30,10,5,8,2,5,30,44,30,2,44,30,40,37,2,40,37,10,37,2,
10,37,5,30
1740 DATA 8,0,20,4,20,15,0,20,15,28,15,0,28,15,28,4,8,0,12,20,12,27,0,1
2,27,20,27,0,20,27,20,20,8,0,28,20,28,27,0,28,27,36,27,0,36,27,36,20,88
,999
1750 REMark road
1760 DATA 8,4,0,0,50,0,4,50,0,50,25,4,50,25,0,25,4,0,25,0,0,8,5,0,25,50
,25,50,25,50,68,5,50,68,0,68,5,0,68,0,0,8,0,15,0,22,25,0,22,25,26,25,
0,26,25,32,0,0,32,0,15,0,88,999
1770 REMark Ghost
1780 DATA 7,0,0,0,0,10,5,40,45,40,-3.142,7,5,40,5,17,10,5,17,12,17,3.14
,10,12,17,19,17,3.14,10,19,17,26,17,3.14,10,26,17,33,17,3.14,10,33,17,4
0,17,3.14,10,40,17,47,17,3.14,7,45,17,45,40
1790 DATA 8,10,11,40,24,40,3.14,10,24,40,11,40,3.14,8,10,28,40,41,40,3.1
4,10,41,40,28,40,3.14,8,0,0,0,0,10,15,40,20,40,3.14,10,20,40,15,40,3
.14,8,10,32,40,37,40,3.14,10,37,40,32,40,3.14,88,9,0,0,0,0,999
1800 REMark Skull
1810 DATA 8,6,17,27,17,35,10,17,35,30,35,-5.4,6,30,35,30,27,6,30,35,17,
35,88,0,38,55,38,30,8,11,19,47,4,1,PI,8,11,31,47,4,1,PI,8,0,21,38,24,43
,0,24,43,27,38,0,27,38,21,38,88,0,17,27,17,35,999
1820 REMark Castle of Terror
1830 DATA 1,5,5,5,25,1,5,25,0,25,1,0,25,0,38,1,0,38,16,38,1,16,38,16,25
,1,16,25,11,25,1,11,25,11,5,1,11,5,5,1,40,5,40,25,1,40,25,34,25,1,34,5,
25,34,38,1,34,38,50,38,1,50,38,50,25,1,50,25,45,25,1,45,25,45,5,1,45,5,
40,5,1,11,8,39,8,8,1,21,8,21,16
1840 DATA 10,21,16,27,16,-3.14,1,27,16,27,8,1,27,8,21,8,1,21,16,27,16,8
,1,16,32,34,32,999
1850 REMark Axe
1860 DATA 8,3,0,0,50,0,3,50,0,50,68,3,50,68,0,68,3,0,68,0,0,88,5,0,0,0,
0,10,20,57,30,50,2,10,20,35,30,44,-2,10,21,57,20,35,2.4,9,3,21,57,0,8,2

```

BRADfORDS

Micro Computer Specialists
with over 5 years of
Micro Experience

MICROS

Amstrad, Sanyo, Apricot, Olivetti.

PRINTERS

Epson, Shinwa, Brother, Juki (also monitors, disk drives, printer buffers and T switches).

SOFTWARE

Sage Accounts, Communications, Bespoke.

SERVICES

Computer repair (free estimate), custom programming, custom cables, interfaces, upgrades.

COMPUTER SUPPLIES

Printer ribbons, listing paper, mailing labels, floppy disks: 3", 3 1/2", 5 1/4", disk boxes, printout binders, cable connectors and spares.

Please call or send for latest price list:

LOGICAL MICRO SYSTEMS

1st Floor, Legrams Mill
Summerville Road, Bradford BD7 1NH
Tel: (0274) 731967

MEGABUFFER



Universal Print Buffer

- 64/128/192/256K RAM FOR LARGE PRINTOUTS
- WORKS WITH MOST COMPUTERS AND PRINTERS
- PARALLEL/PARALLEL, PARALLEL/SERIAL AND SERIAL/PARALLEL MODES
- MULTIPLE COPY AND PAGE REPRINT FACILITIES
- STRAIGHT-THROUGH MODE
USE FOR INTERFACE CONVERSION ONLY
- INDUSTRY-STANDARD CONNECTORS
- INTERNAL POWER SUPPLY
- HIGH QUALITY CONSTRUCTION, BUILT TO LAST
- BRITISH DESIGNED AND MANUFACTURED

64K £180 - 128K £216 - 192K £252 - 256K £288
CABLES £15 (send full details of Computer and Printer)

RINGDALE PERIPHERALS, 11 Decoy Road, Worthing,
Telephone (0903) 213131 West Sussex, BN14 BND

DAISYWRITER 2000

THE PRINTER THAT THINKS IT'S A COMPUTER

IBM compatibility to the letter with the highest quality print to meet today's professional and business applications

DAISYWRITER 2000 comes complete with a unique universal interface providing compatibility for a wide range of micros and PCs. It allows you to emulate the protocols of almost every letter quality printer on the market today.

How does the most intelligent letter quality printer in the world perform MORE WORK than printers requiring twice the investment, rated at 40cps, that don't offer half of the DAISYWRITER's features?

The key is THROUGHPUT

HIGH SPEED THROUGHPUT is accomplished by utilising a large buffer memory (48K) and special firmware. The DAISYWRITER 2000 zips along at up to 200cps through all "white space", with paper and carriage moving simultaneously, thus increasing effective throughput to over 40cps without sacrificing print quality.

DAISYWRITER 2000 gives full compatibility with:

IBM DISPLAYWRITE II, WORDCRAFT, WORDSTAR and many more WP software packages.

In fact, with over 100 internal word processing commands you could even write your own word processing package.

Paper handling is simple, with front fascia controls for pitch, line spacing, top of form, line feed and halt button. A selection of 20 different printwheels are available in 16 languages. Bring out the best in your PC with a professional quality printer offering reliability and throughput. Full after-sales service guaranteed with 6 months warranty.

Premier Systems International

Sales & Service Dept (Printers)
Heatherside House, Camden Road, Maidenhead
Berks SL6 6HA Tel: (0628) 34302

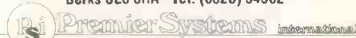

```
,27,55,27,5,2,27,5,31,5,2,31,5,31,55,2,31,55,27,55,88,4,30,44,30,50,999
1870 REMark Circles1
1880 DATA 8,1,0,0,50,0,1,50,0,50,68,1,50,68,0,68,1,0,68,0,0,8,6,0,0,0,0
,11,26,33,20,1,PI,8,2,0,0,0,0,11,26,33,14,1,PI,8,5,0,0,0,0,11,26,33,8,1
,PI,8,3,0,0,0,0,11,26,33,4,1,PI,88,999
1890 REMark Memoire
1900 DEFine PROCEDURE Memoire
1910 RESTORE 1950:FOR k=1TO 7
1920 READ a$:INK#ch,k:CURSOR#ch,2+k+(k-1)*7,2+(k-1)*9:PRINT#ch,a$:NEXT
k
1930 INK#ch,7
1940 END DEFine Memoire
1950 DATA "M","E","M","O","I","R","E"
1960 REMark Blocks
1970 DATA 8,4,0,0,50,0,4,50,0,50,68,4,50,68,0,68,4,0,68,0,0,8,2,25,0,50
,0,2,50,0,50,57,2,50,57,25,57,2,25,57,25,0,8,5,0,0,20,0,5,20,0,20,16,5
,20,16,0,16,5,0,16,0,0,8,1,11,10,30,10,1,30,10,30,22,1,30,22,11,22,1,11
,22,11,10
1980 DATA 8,3,34,0,50,18,3,50,18,22,62,3,22,62,6,50,3,6,50,34,0,88,999
1990 REMark Sword
2000 DATA 8,2,20,68,26,68,2,26,68,26,55,2,26,55,33,55,2,33,55,33,50,2,3
3,50,13,50,2,13,50,2,13,55,2,13,55,20,55,2,20,55,20,68,8,6,18,48,22,0,6,2
2,0,28,48,6,28,48,18,48,88,6,22,0,22,40,999
2010 REMark Club
2020 DATA 8,4,0,0,50,0,4,50,0,50,68,4,50,68,0,68,4,0,68,0,0,8,0,19,10,3
2,10,0,32,10,28,24,0,28,24,23,24,0,23,24,19,10,8,11,26,52,11,1,PI,8,11
,37,32,11,1,PI,8,11,14,32,11,1,PI,88,999
2030 REMark Heart
2040 DATA 8,2,25,4,10,35,2,10,35,40,35,2,40,35,25,4,8,10,10,35,25,33,-4
,8,10,25,33,40,35,-4,88,999
2050 REMark Spade
2060 DATA 8,3,0,0,50,0,3,50,0,50,68,3,50,68,0,68,3,0,68,0,0,8,0,20,10,3
0,10,0,30,10,25,30,0,25,30,20,10,8,0,26,67,10,35,0,10,35,40,35,0,40,35
,26,67,8,10,10,35,25,37,4,8,10,26,37,40,35,4,88,999
2070 REMark Diamond
2080 DATA 8,2,25,4,45,30,2,45,30,25,59,2,25,59,5,30,2,5,30,25,4,88,999
2090 REMark Star of David
2100 DATA 8,6,5,10,50,40,6,50,40,17,40,6,17,40,5,10,6,6,0,40,45,10,6,45
,10,32,40,6,32,40,0,40,8,6,25,57,5,10,6,5,10,37,30,6,37,30,25,57,88,999
2110 REMark Diode
2120 DATA 8,5,0,0,50,0,5,50,0,50,68,5,50,68,0,68,5,0,68,0,0,8,0,15,20,3
5,20,0,35,20,35,25,0,35,25,15,25,0,15,25,15,20,88,0,15,40,35,40,0,35,40
,25,25,0,25,25,15,40,11,25,31,18,1,PI,0,25,0,25,68,999
2130 REMark Box
2140 DATA 8,5,5,10,35,10,5,35,10,35,20,5,35,20,5,10,20,5,10,20,10,40,5,10
,40,5,40,5,40,5,10,8,3,35,10,40,20,3,40,20,40,50,3,40,50,10,50,3,10,5
0,5,40,3,5,40,35,40,3,35,40,35,10,8,2,10,21,35,21,2,35,21,35,39,2,35,39
,10,39,2,10,39,10,21,88,999
2150 REMark Tennis
2160 DATA 8,7,24,0,26,0,7,26,0,26,30,7,26,30,24,30,7,24,30,24,0,88,11,2
4,50,17,PI/5,0,88,9,7,23,31,0,9,7,26,31,0,2,18,35,18,64,2,25,34,25,67,2
,31,33,31,64,2,17,60,34,60,2,16,50,34,50,2,18,42,31,42,2,1,38,29,38
2170 DATA 2,17,46,33,46,2,17,55,33,55,2,21,64,31,64,2,22,66,22,36,2,28
,66,28,36,999
2180 REMark Boat
2190 DATA 8,4,1,30,50,30,4,50,30,36,15,4,36,15,7,15,4,7,15,1,30,8,2,19,
30,19,68,2,19,68,22,68,2,22,68,22,30,2,22,30,19,30,8,5,24,55,24,38,5,24
,38,37,38,5,37,38,24,55,8,5,17,65,17,38,5,17,38,2,38,5,2,38,17,65,88,99
9
2200 REMark Pale
2210 DATA 6,10,34,17,8,11,25,34,15,-2,PI/2,10,17,8,33,8,1.2,6,33,8,40,3
4,10,10,34,40,34,-3.4,999
2220 REMark Arrows
2230 DATA 3,22,45,28,45,3,28,45,28,51,3,30,51,25,58,3,25,58,20,51,3,22
,51,22,45,3,35,32,40,32,3,40,30,47,35,3,47,35,40,40,3,40,38,35,38,3,35,3
8,35,32,3,15,32,10,32,3,10,30,3,35,3,3,35,10,40,3,10,38,15,38,3,15,38,1
5,32
2240 DATA 3,22,25,28,25,3,28,25,28,20,3,30,20,25,13,3,25,13,20,20,3,22
,20,22,25,999
2250 REMark Longbow
2260 DATA 2,25,60,42,33,2,42,33,25,5,10,25,60,26,5,2,8,4,37,34,44,34,4,
44,34,44,32,4,44,32,37,32,4,37,32,37,34,88,4,38,33,6,33,8,4,6,33,12,36
,4,12,36,12,30,4,12,30,6,33,88,999
2270 REMark Muncher
2280 DATA 6,0,0,0,0,8,10,6,45,41,25,-3.2,6,6,45,41,25,8,10,6,25,41,45,3
.2,6,6,25,41,45,0,0,0,0,0,8,11,28,44,5,1,PI,88,999
2290 REMark Globe
2300 DATA 5,0,0,0,0,11,25,34,20,1,PI,11,25,34,20,.7,PI/2,11,25,34,20,.3
,PI/2,11,25,34,20,.6,PI,11,25,34,20,.3,PI,999
2310 REMark Rainbow
2320 DATA 8,1,0,34,50,34,1,50,34,50,68,1,50,68,0,68,1,0,68,0,34,0,0,0,0
,0,8,11,25,34,23,1,0,8,1,0,0,0,0,11,25,34,11,1,0,88,11,25,34,13,1,0,3,0
,0,0,0,11,25,34,15,1,0,4,0,0,0,0,11,25,34,17,1,0,5,0,0,0,0,11,25,34,19
,1,0
2330 DATA 6,0,0,0,0,11,25,34,21,1,0,1,0,0,0,0,11,25,34,23,1,0,8,4,0,32
,50,32,4,50,32,50,0,4,50,0,0,4,0,0,0,0,32,88,7,4,56,4,46,7,8,56,8,50,8,1
1,11,61,8,-4,PI/2,999
2340 REMark Dice
2350 DATA 4,2,20,23,20,4,23,20,23,45,4,23,45,2,45,4,2,45,2,20,4,26,20,4
8,20,4,48,20,48,45,4,48,45,26,45,4,26,45,26,20,5,0,0,0,8,11,13,32,2,1
,0,8,8,11,32,40,2,1,0,8,11,44,40,2,1,0,8,11,32,25,2,1,0,8,11,44,25,2,1
,0,88,999
2360 REMark Sine Wave
2370 DATA 6,7,20,7,45,6,0,32,50,32,4,0,0,0,0,10,8,31,28,31,-3.4,10,28,3
0,49,30,PI,999
2380 REMark Traffic Lights
2390 DATA 7,18,20,32,20,7,32,20,32,60,7,32,60,18,60,7,18,60,18,20,7,24
0,24,20,7,26,0,26,20,2,0,0,0,8,11,26,52,5,1,0,6,0,0,0,0,8,11,26,40,5
,1,0,4,0,0,0,0,8,11,26,28,5,1,0,999
2400 REMark Uneven Road
2410 DATA 8,2,0,10,25,55,2,25,55,51,10,2,51,10,0,10,8,7,8,14,25,47,7,25
,47,42,14,7,41,14,7,14,8,0,15,18,35,18,0,35,18,35,21,0,35,21,15,21,0,15
,21,15,18,8,10,17,20,23,20,-3.5,8,10,27,20,33,20,-3.5,88,999
2420 REMark TV
2430 DATA 8,7,0,10,50,10,7,50,10,50,45,7,50,45,0,45,7,0,45,0,10,8,0,8,4
2,30,42,10,30,42,29,14,-1.2,0,29,14,8,14,10,8,14,9,42,-1.2,8,2,37,14,37
,30,2,37,30,47,30,2,47,30,47,14,2,47,14,37,14,999
2440 REMark Shapes
2450 DATA 8,1,0,0,50,0,1,50,0,50,68,1,50,68,0,68,1,0,68,0,0,8,5,10,60,1
```

PROGRAM FILE

MICROMART

```

0,30,5,10,30,50,10,5,50,10,50,40,5,50,40,10,60,8,0,0,0,0,11,32,56,15,
1,0,8,3,19,54,40,4,3,40,4,5,23,3,5,23,19,54,999
2460 REMark Door
2470 DATA 8,4,0,0,50,0,4,50,0,50,10,4,50,10,0,10,4,0,10,0,0,8,5,0,10,50
,10,5,50,10,50,68,5,50,68,0,68,5,0,68,0,10,8,7,10,10,38,10,7,38,10,38,6
,0,7,38,60,10,60,7,10,60,10,10,8,0,13,13,36,13,0,36,13,36,32,0,36,32,13
,32,0,13,32,13,13,8
2480 DATA 0,13,40,36,40,0,36,40,36,58,0,36,58,13,58,0,13,58,13,40,8,11
,33,35,3,1,0,999
2490 REMark Transistor
2500 DATA 11,25,35,15,1,0,8,7,21,27,25,27,7,25,27,25,45,7,25,45,21,45,7
,21,45,21,27,8,7,25,30,29,30,7,29,30,27,25,7,27,25,25,30,88,7,25,30,32
,23,7,20,35,0,35,7,32,23,32,0,7,25,41,34,48,7,34,48,34,68,999
2510 REMark Ok!
2520 DATA 7,22,35,22,44,10,22,44,27,44,-3,7,22,35,18,35,10,19,35,18,30
,3,10,19,30,18,25,3,10,19,25,18,20,3,10,19,20,18,15,3,7,18,15,50,20,7,18
,30,23,30,7,18,25,23,26,7,18,20,23,21,7,18,15,23,17,9,0,16,30,0,7,27,44
,27,35,7,27,35,30,31,7,30,31,50,31,999
2530 REMark Jaws!!
2540 DATA 4,50,40,17,60,10,17,60,11,55,3,4,11,55,44,25,4,44,25,10,10,10
,10,10,13,5,3,4,13,5,50,13,2,0,0,0,11,46,34,2,1,0,999
2550 REMark Treble Clef
2560 DEFINE PROCEDURE CLEF
2570 PAPER#ch,5:CLS#ch:INK#ch,0:PAPER#ch,0:SCALE#ch,25,0,0:LINE#ch,9,10
2580 ARC_R#ch TO 0,4.5,-PI
2590 ARC_R#ch TO 0,-6,-PI TO -3,7,-3*PI/4
2600 LINE_R#ch TO 5,7:ARC_R#ch TO -2,0,PI
2610 LINE_R#ch TO 0,-18
2620 FILL#ch,1:CIRCLE_R#ch,-1,0,1:FILL#ch,0:SCALE#ch,68,0,0
2630 END DEFINE CLEF
2640 REMark Key
2650 DATA 8,5,0,0,50,0,5,50,0,50,68,5,50,68,0,68,5,0,68,0,0,8,2,0,0,0,0
,10,20,40,25,40,-5.8,8,5,0,0,0,0,11,22,50,6,1,0,8,2,20,40,20,5,10,20,5
,25,5,4,2,25,5,33,5,2,33,5,33,10,2,33,10,27,10,2,27,10,27,15,2,27,15,33
,15,2,33,15,33,20,2,33,20,25,20,2,25,20,25,40,88,999
2660 REMark Numero Uno
2670 DATA 8,3,5,3,45,3,3,45,3,45,10,3,45,10,30,10,3,30,10,30,65,3,30,65
,20,65,3,20,65,10,55,3,10,55,20,55,3,20,55,20,10,3,20,10,5,10,3,5,10,5
,3,88
2680 DATA 5,5,3,45,3,5,45,3,45,10,5,45,10,30,10,5,30,10,30,65,5,30,65,2
0,65,5,20,65,10,55,5,10,55,20,55,5,20,55,20,10,5,20,10,5,10,5,5,10,5,3
,999
2690 REMark Tick!!!
2700 DATA 4,0,0,0,0,10,5,25,23,5,-1.2,10,23,5,50,58,-.7,10,50,58,19,22
,1.2,10,5,25,20,22,-2,999
2710 REMark Passage
2720 DEFINE PROCEDURE pass
2730 BORDER#ch,7,2:PAPER#ch,3:CLS#ch:BORDER#ch,5:PAPER#ch,4:CLS#ch:BORD
ER#ch,10:PAPER#ch,5:CLS#ch:BORDER#ch,15:PAPER#ch,6:CLS#ch:BORDER#ch
2740 END DEFINE pass
    
```

Goto Computers Ltd.

GO TO Goto HI-TECH AT THE BEGINNING OF SILICON VALLEY — SLOUGH! COMPUTERS

CANON A-200, COMMODORE PC10 and 20, APRICOT
Fi & Fib, BBC 'B', AMSTRAD, etc.

PRINTERS

JUKI 6100, CANON 1080A, + 1156A, EPSON,
MANNESMAN TALLY, BROTHER, SHINWA, etc.

MONITORS

MICROVITEC, PHILIPS, COMMODORE, FERGUSON

DRIVES

OPUS, CUMANA

ACCESSORIES

3M and Elephant disks, ribbons, daisywheels, leads,
print heads, etc.

Goto HI-TECH AT SLOUGH

10 Old Crown, Windsor Road, Slough, Berks,
SL1 2DI

For the best prices in the Thames Valley
Tel: Slough (0753) 34191

WDSOFTWARE

For the QL

WD Utilities (3rd ed) (base £5.50)
PRINT 60-file Directory or view it on one screen, one-key LOAD COPY or
PRINT 60 files with one key (allows for namesakes). Multiple FORMATTING to
prevent corruption by stretching of tape. TOOLKIT to give dated, numbered
modules in program development. PRUNE old files to release space (one key
DELETES a file). Full instructions in QULL file. Use up to 6 EXTRA
MICRODRIVES (add on your Spectrum ones!)

WD Utilities for CST Drives (base £8)
100-file capacity, for CST/Computatmate disk system AND up to 4 extra
microdrives. User-friendly timesavers.

RefQL (4th ed) (base £4)
700 useful QL references in an ARCHIVE file. (Too long to share cartridge
with other software).

For Spectrum/QL/BBC

WD Morse Tutor (base £4)
From absolute beginner to beyond RYA and Amateur Radio receiving. Adjust
pitch. Set speed to your test level (4-18 wpm). Learn from single characters,
via groups with wide spaces to random sentences; decrease spacing to
normal. Write down what you hear, then CHECK on Screen or Printer (or
speech for Spectrum fitted with Currah Microspeech). Also own message,
random figures, letters or mixed.

For Spectrum 48K

Tradewind (base £4)
Sailing/trading strategy game with graphic surprises.

Jersey Quest (base £4)
Text adventure with Bergerac and the Dragon. (not disk)
Prices: (incl Europe postage, elsewhere add £1). Spectrum/BBC cassettes,
base price only. QL or Spectrum Microdrives. £2/cartridge plus base price.
5 1/4" floppies. £2 plus base; 3 1/2" floppies. £4 plus base (SPDOS or TRDOS format
for Spectrum).

Two or more programs on one medium — pay medium plus base EG. WD Utilities
and Morse for £11.50, but IMPOSSIBLE to mix QL/BBC/Spectrum programs on one
medium. Send YOUR cartridge and base price, but FORMAT it FIRST in your DRIVE 1
for compatibility.

WDSOFTWARE, Hilltop, St Mary, Jersey.
Tel: (0534) 81392

Spectrum Nighthawk by Richard Whitfield

Nighthawk is a game for the 48k Sinclair Full instructions are included in the
Spectrum that involves flying a combat program, which includes a high-score
helicopter to destroy tanks before fuel table and is written entirely in Basic.
runs out.

```

O>REM Nighthawk 1985 by R.Whitfield
Any transmitting,copying, lending,hiring or broad-
casting of this program without the author's written co-
nsent is STRICTLY PROHIBITED.
1 BORDER 0: PAPER 0: INK 7: BRIGHT 1: CLS
5 LET scorepos=14
6 REM DEFINE CHARACTERS
7 FOR f=0 TO 7: READ a: POKE USR "a"+f,a: NEXT f: DATA 60,2,57,72,16,32,64,12
8
8 FOR f=0 TO 7: READ a: POKE USR "1"+f,a: NEXT f: DATA 0,0,16,10,141,89,41,24
7
9 FOR f=0 TO 7: READ a: POKE USR "k"+f,a: NEXT f: DATA 200,81,105,36,5,0,16,2
07
10 FOR f=0 TO 7: READ a: POKE USR "j"+f,a: NEXT f: DATA 52,72,128,0,0,26,36,19
5
11 FOR f=0 TO 7: READ a: POKE USR "i"+f,a: NEXT f: DATA 24,60,24,24,60,36,102,
24
12 FOR f=0 TO 7: READ a: POKE USR "h"+f,a: NEXT f: DATA 60,24,129,195,195,129,
24,60
13 FOR f=0 TO 7: READ a: POKE USR "g"+f,a: NEXT f: DATA 252,2,249,72,16,32,64,
128
14 FOR f=0 TO 7: READ a: POKE USR "f"+f,a: NEXT f: DATA 255,0,255,102,153,153,
102,255
15 FOR f=0 TO 7: READ a: POKE USR "e"+f,a: NEXT f: DATA 0,0,127,3,0,0,0,48
16 FOR f=0 TO 7: READ a: POKE USR "d"+f,a: NEXT f: DATA 63,64,159,18,8,4,2,1
17 FOR f=0 TO 7: READ a: POKE USR "c"+f,a: NEXT f: DATA 28,62,242,251,59,31,25
5,252
18 FOR f=0 TO 7: READ a: POKE USR "b"+f,a: NEXT f: DATA 24,60,126,126,126,126,
60,24
19 FOR f=0 TO 7: READ a: POKE USR "a"+f,a: NEXT f: DATA 6,9,9,9,6,0,0,0
20 REM GOTD INTRODUCTION SEQUENCE
21 GO TO 9500
30 PLOT 54,77: DRAW 179,0: DRAW 0,13: DRAW -179,0: DRAW 0,-13: PRINT AT 11,7:
INK 7: PAPER 2: FLASH 1: BRIGHT 1: PREPARE FOR TAKE-OFF "
35 FOR F=0 TO 40: BEEP 0.1,20: BEEP 0.1,15: NEXT F
40 CLS
41 REM SET UP VARIABLES & SCREEN DISPLAY
45 LET jat=0: LET time=0: LET eneb=INT (j+(359*RD)): LET enearng=INT (30+20
0*RD): LET k=0: LET dam=0: LET x1=70: LET x2=70: LET up=0: LET j=2: LET can=0:
LET rock=0: LET be=0: LET alt=0: LET power=0: LET spe=(power/20): LET cannon=60
00: LET missile=30: LET track=0: LET fuel=1000000-(power/2000): LET dam=0: LET d
s="NONE": LET kill=0: LET hkill=0: LET type=0: LET found=0
46 LET powerpos=B+(power/100): LET spepos=B+(spe/5): LET fuelpos=B+(fuel/10000
)
47 LET dcol1=0: LET dcol2=0: LET dcol3=0: LET dcol4=0: LET dcol5=0: LET dcol6=
0: LET dcol7=0: LET dcol8=0: LET dcol9=0: LET dcol10=0: LET hozx=0: LET hozy=70
    
```

CALLING ALL SHARP MZ-700 OWNERS

AN AUTUMN SPECTACULAR
10 EXCITING GAMES AND UTILITIES
ON ONE CASSETTE

COMPENDIUM

Featuring everything from arcade style action,
games of interest, popular family games of luck and
skill to some useful utility programs.

INCLUDES

A special tutorial designed to show YOU how to write
games, address screen locations, Pokeing and
Peeking, colour data, movement... and much more...

With full colour graphics and sound, making this an
offer not to be missed...

AT ONLY £4.90 + 25p P&P

Only available from:

A.B.S SOFTWARE

3 DERWENT VIEW, HACKNEY
MATLOCK, DERBYSHIRE DE4 3PX
Cheques made payable to A.B.S Software

PROGRAM FILE

```
radar": BEEP 0.1,40: PAUSE 10: PRINT AT 19,12;"
226 IF alt>400 THEN PRINT AT 6,12: PAPER 2; INK 7; BRIGHT 1; FLASH 1;"enemy AA
M":AT 7,13; INK 7; PAPER 2; FLASH 1; BRIGHT 1;"launch ": FOR n=0 TO 9: BEEP 0.1,
50: NEXT n: GO TO B950
227 IF hozy<29 THEN LET hozy=29
228 IF hozy=100 THEN LET hozy=100
230 PRINT AT 6,28; missile
235 IF alt>0 THEN PRINT AT 3,24; INK 7; PAPER 2; alt;"ft "
240 IF alt<=0 AND up>3 THEN PRINT AT 3,24; INK 7; PAPER 1; FLASH 1;"oft ": P
AUSE 20: BEEP 1,30: GO TO 7900
245 IF dam=100 THEN GO TO 9350
250 PLOT OVER 0; INK 4; 91,hozy: DRAW OVER 0; INK 4; 76,hoz
255 IF enemrg<15 AND enembe>be THEN PRINT AT 6,12; PAPER 2; INK 7; FLASH 1; B
RIGHT 1;"D.S. ON ": BEEP 0.05,40: GO TO 260
259 PRINT AT 6,12; PAPER 2; INK 7; BRIGHT 0;"C.S. OFF": GO TO 140
263 REM PRINT TANK & SET UP COMBAT SEQUENCE
264 LET hozy=70: LET hozx=0: LET x1=70: LET x2=70: LET alt=alt
265 LET at=0: PRINT AT 8,12; INK 2; BRIGHT 1;"NSight on"
266 FOR n=9 TO 18: PRINT AT n,11; PAPER 8;" ": BEEP 0.001,60: NEXT n:
LET dur=INT (8*RND): LET tpx=12+INT (3*RND): LET a=0: LET b=30: LET cx=16: LET
cy=14: LET can=0: LET rock=0: LET a$=" ": LET b$=" "
267 LET tpy=11+INT (6*RND)
268 PRINT AT tpy,tpx+1; INK 2; PAPER 0;a$;AT tpy+1,tpx; INK 2; PAPER 0;b$
269 REM PRINT CROSSHAIRS
270 IF IN 64510=183 THEN LET rock=1: LET can=0
271 IF IN 65278=183 THEN LET rock=0: LET can=1
272 IF IN 63486=175 AND cx>12 THEN PRINT AT cy,cx; PAPER 8;" ": LET cx=cx-1: L
ET cy=cy: LET a=a-8: PRINT AT cy,cx; INK 4; PAPER 8; OVER 1;" "
273 IF IN 61438=175 AND cy<17 THEN PRINT AT cy,cx; PAPER 8;" ": LET cx=cx: LET
cy=cy+1: LET b=b-8: PRINT AT cy,cx; INK 4; PAPER 8; OVER 1;" "
274 IF IN 61438=183 AND cy>9 THEN PRINT AT cy,cx; PAPER 8;" ": LET cx=cx: LET
cy=cy-1: LET b=b+8: PRINT AT cy,cx; INK 4; PAPER 8; OVER 1;" "
275 IF IN 61438=187 AND cx<19 THEN PRINT AT cy,cx; PAPER 8;" ": LET cx=cx+1: L
ET cy=cy: LET a=a+8: PRINT AT cy,cx; INK 4; PAPER 8; OVER 1;" "
276 IF enembe<be THEN LET dur=0
289 REM CANNON FIRE ROUTINE
290 IF IN 61438=190 AND can=1 AND cannon>0 THEN LET at=10: LET cannon=cannon-1
00: PRINT AT 13,26;" ":AT 13,26;cannon: FOR n=0 TO 6: PLOT INK 4; PAPER 8; 0
VER 1;131,30: DRAW INK 4; PAPER 8; OVER 1;a,b: BEEP 0.001,50: NEXT n: PLOT INK
4; PAPER 8; OVER 1;131,30: DRAW INK 4; PAPER 8; OVER 1;a,b
291 REM MISSILE FIRE ROUTINE
292 IF IN 61438=190 AND rock=1 AND missile>0 THEN LET at=10: LET missile=missi
le-1: PRINT AT 6,28;" ":AT 6,28;missile: FOR n=17 TO cy+1 STEP -1: PRINT AT n,c
x; INK 7; BRIGHT 1;" ": BEEP 0.005,45: PAUSE 4: PRINT AT n,cx; PAPER 8;" ": NEX
T n
293 IF at=10 AND cy=tpy AND cx=tpx+2 THEN LET dur=0: BEEP 1,-40: BEEP 0.5,-35:
PRINT AT tpy,tpx+1; PAPER 8;" ":AT tpy+1,tpx; INK 3;" ": LET kill=kill
+1: PRINT AT 10,12; INK 4; BRIGHT 1;"TARGET";AT 11,12; INK 4; BRIGHT 1;"DESTROYE
D": PAUSE 80: PRINT AT tpy,tpx+1; PAPER 8;" ":AT tpy+1,tpx; PAPER 8;" ":
10,12; PAPER 8;" ":AT 11,12; PAPER 8;" ": FOR n=0 TO 30: BEEP 0.01,
20: BEEP 0.01,24: NEXT n: GO TO 301
294 LET at=0
298 LET dur=dur-1: LET enemrg=enemrg-1
299 IF dur>0 THEN PRINT AT tpy,tpx+1; INK 2;a$;AT tpy+1,tpx; INK 2;b$: GO TO 3
09
300 IF dur=0 THEN FOR n=tpx+1 TO 17: PRINT AT n-1,tpx+1; INK 2;a$;AT n,tpx; IN
K 2;b$: BEEP 0.01,0: PRINT AT n-1,tpx+1;" ":AT n,tpx;" ": NEXT n
301 FOR n=30 TO 70: PLOT INK 4; 91,n: DRAW INK 4; 76,0: BEEP 0.001,60: NEXT n:
LET enemrg=enemrg+17: PRINT AT 17,26; INK 7; PAPER 2; BRIGHT 1;enemrg
302 LET enembe=enembe+180
303 IF enembe>360 THEN LET enembe=enembe-360
304 PRINT AT 3,14; INK 7; BRIGHT 1; PAPER 1;" ":AT 3,14; INK 7; BRIGHT 1; PA
PER 1;enembe;" "
305 PRINT AT 8,12; PAPER 0;" "
306 LET jat=0
307 GO TO 140
308 REM FLAK DAMAGE
309 LET flak=INT (100*RND)
310 IF flak=10 THEN LET dcol1=2: LET dam=dam+10
311 IF flak=20 THEN LET dcol2=2: LET dam=dam+10
312 IF flak=30 THEN LET dcol3=2: LET dam=dam+10
313 IF flak=40 THEN LET dcol4=2: LET dam=dam+10
314 IF flak=50 THEN LET dcol5=2: LET dam=dam+10
315 IF flak=60 THEN LET dcol6=2: LET dam=dam+10
316 IF flak=70 THEN LET dcol7=2: LET dam=dam+10
317 IF flak=80 THEN LET dcol8=2: LET dam=dam+10
318 IF flak=90 THEN LET dcol9=2: LET dam=dam+10
319 IF flak=100 THEN LET dcol10=2: LET dam=dam+10
320 IF dam>=100 THEN GO TO 9350
321 PRINT AT 21,18; INK 7; PAPER 2; BRIGHT 1;" ":AT 21,18; INK 7; BRIGHT 1;
PAPER 2;dam;"%"
322 IF IN 65022=187 THEN LET damr=10: LET jat=10: GO TO 6000
350 GO TO 268
400 GO TO 140
5999 REM DRAW HELICOPTER AND SHOW DAMAGE FOR DAMAGE REVIEW
6000 IF damr=10 THEN FOR n=15 TO 20: PRINT AT n,26; INK 0; PAPER 0; OVER 0;"
": NEXT n: INK 7; BRIGHT 1
6001 PLOT 210,27: DRAW 2,1: DRAW 2,1: DRAW 2,1: DRAW 3,4: DRAW 2,1: DRAW 3,0: DR
AW 2,1: DRAW 0,2: DRAW 3,0: DRAW 1,-2: DRAW 2,-1: DRAW 2,-3: DRAW 0,-1: DRAW 7,-
1: DRAW 3,4
6002 DRAW -1,1: DRAW 2,0: DRAW -1,-6: DRAW 1,-5: DRAW -2,0: DRAW -3,3: DRAW -11,-
1: DRAW -2,-1: DRAW -8,-1: DRAW -2,-2: DRAW -3,0: DRAW -1,1: DRAW 0,2: DRAW -4,0
: DRAW -2,1
6003 PLOT 209,38: DRAW 36,2
6004 PRINT AT 18,26; PAPER dcol1; OVER 1;" "
6005 PRINT AT 18,27; PAPER dcol2; OVER 1;" "
6006 PRINT AT 18,28; PAPER dcol3; OVER 1;" "
6007 PRINT AT 18,29; PAPER dcol4; OVER 1;" "
6008 PRINT AT 18,30; PAPER dcol5; OVER 1;" "
6009 PRINT AT 17,26; PAPER dcol6; OVER 1;" "
6010 PRINT AT 17,27; PAPER dcol7; OVER 1;" "
6011 PRINT AT 17,28; PAPER dcol8; OVER 1;" "
6012 PRINT AT 17,29; PAPER dcol9; OVER 1;" "
6013 PRINT AT 17,30; PAPER dcol10; OVER 1;" "
6014 BEEP 1,20: FOR n=15 TO 20: PRINT AT n,26; INK 0; PAPER 0;" ": NEXT n: L
ET damr=0
6015 IF jat=0 THEN GO TO 140
6016 IF jat=10 THEN GO TO 270
6020 BEEP 1,20: FOR n=15 TO 20: PRINT AT n,26; INK 0; PAPER 0;" ": NEXT n: L
ET damr=0: GO TO 140
6029 REM DIRECTION-FINDER ROUTINE
6030 FOR n=15 TO 20: PRINT AT n,26; INK 0; PAPER 0; OVER 0;" ": NEXT n
6031 CIRCLE 229,32,16: PLOT 229,46: DRAW 0,4: PLOT 243,32: DRAW 4,0: PLOT 229,18
: DRAW 0,-4: PLOT 216,32: DRAW -4,0
6032 IF enembe>0 AND enembe<90 THEN PLOT 229,32: DRAW 9,9
6033 IF enembe>91 AND enembe<180 THEN PLOT 229,32: DRAW 9,-9
6034 IF enembe>181 AND enembe<270 THEN PLOT 229,32: DRAW -9,-9
6035 IF enembe>271 AND enembe<360 THEN PLOT 229,32: DRAW -9,9
6036 IF enembe=180 THEN PLOT 229,32: DRAW 0,-9
6037 IF enembe=0 THEN PLOT 229,32: DRAW 0,9
6038 IF enembe=90 THEN PLOT 229,32: DRAW 9,0
6039 IF enembe=270 THEN PLOT 229,32: DRAW -9,0
6040 BEEP 1,20: FOR n=15 TO 20: PRINT AT n,26; INK 0; PAPER 0; OVER 0;" ": N
EXT n: GO TO 140
```

MICROMART

COMPUTERS

Apricot PC	from £1390
Apricot Xi 10Mb	£2190
Commodore PC10	£1424
Commodore PC20	£2375
Commodore 8296	£680
Commodore 8250	£765
Victor VPC15	£2499

DAISYWHEEL PRINTERS

Triumph-Adler TRD7020	£375
Ricoh 1200	£499
Ricoh 1600QS-8	£1415

MATRIX PRINTERS

Sakata 1200+ 120cps	£290
Sakata 1500 180cps	£399
Epson RX80T	£217
Epson SQ2000 Ink Jet	POA
Oki 182	£274

Many more offers — Please phone for advice and prices

PRIMTON COMPUTER SERVICES
24 Green Lane, NW4 2NG Tel. 01-203 3777



THE CRACKER

The spreadsheet designed for normal people who make mistakes. Instant error detection and easy correction. Yes, this is a special feature. It means that what you do is right, first time, most times. For Businessmen, Engineers, Scientists and most simulators.
£100+£2pp+VAT, CPM-Z80, CPM-86, MP/M-86, CCP/M-86, MSDOS, PCDOS

DISASSEMBLERS, Z80, 8086

Powerful practical file based disassemblers. Produces error messages, full listings and cross-reference tables. The 16-bit version suitable for whole 8086 family and 8087. This version can handle .CMD, .COM and .EXE files also ROMS.
£80+VAT, CPM-Z80, CPM-86, MP/M-86, CCP/M-86, MSDOS, PCDOS

TRANSLATOR Z80 TO 8086

This is a single pass translator designed to allow you to get your Z80 source code into an 8086 form easily. It has no real size limit and works fast. Data areas handled intelligently. Output for popular assemblers. An easy way to learn 8086 assembly language.
£80+VAT CPM-Z80, CPM-86, MP/M-86, CCP/M-86, MSDOS, PCDOS

Software Technology Ltd

PO BOX 724, BIRMINGHAM B15 3HQ
TEL: 021-454 3330. TELEX: 337675 TELPES G

1541 FLASH!

Do you get bored waiting for your disk drive to load your favourite programs?

Thinking of reverting to 'turbo' tape routines because they're quicker? WAIT!!!

From SUPERSOFT comes a great NEW product which you can fit in minutes to upgrade your Commodore 64 and 1541 Disk Drive. All disk operations are speeded up as much as THREE times (for example, programs which normally take a minute to load will load in twenty seconds or less using FLASH!)

1541 FLASH! is 100% compatible with Commodore BASIC. However, if you really want to you can easily revert to the normal slow mode at any time — but we don't think you will!

If you take your programming seriously you can speed DATA transfers by up to 10 times normal speed (in your own programs), and can also make use of 11 screen editing functions, as well as 17 disk commands.

Pressing SHIFT and RUN/STOP becomes the same as LOAD. 8.1 so you can start work about five seconds earlier each day!

Supersoft have 1541 FLASH! in stock NOW, so send your cheque for £89.95 or phone 01-861 1166 to order by Access.

P.S. Unlike some add-ons we could mention, 1541 FLASH! leaves you all your memory and the cartridge port available!

SUPERSOFT

Winchester House, Canning Road, Wealdstone,
Harrow, HA3 7SJ

Tel: 01-861 1166 for further details and our free catalogue

IMPROVED SANYO SYSTEMS

SANYO MBC 550
with
INTEGRAL
10 Megabyte
WINCHESTER DRIVE

SHARED WITH a second
MBC 550

ALL-IN with
b/w monitors
£2950 +vat

AND add later:
more terminals
more storage
other MS-DOS
machines



MicroMods TEL: (0602) 724264
53 Acton Rd Long Eaton Nottingham NG10 1FR

SINCLAIR COMPUTER REPAIRS

Fast, reliable repairs by experienced engineers, having serviced Sinclair computers since the introduction of the ZX80. Our price is inclusive of all parts, labour, postage and VAT irrespective of fault. *No hidden charges. *While-you-wait service available. Spectrum £18.75. ZX81 £11.50. 16K Ram £9.95. Call or send with cheque or P.O. to: TV Services of Cambridge Ltd, French's Road, Cambridge CB4 3NP. Tel: (0223) 311371.

Now available

SPECTRUM 'XK' MEMORY EXPANSION SYSTEM

XK System Kit £15.95 inc. VAT
XK System Factory fitted £20.95 inc. VAT

BASIC COMPILER

For the BBC Micro

Now supports over 100 key words
Turns Basic programs into really fast machine code. It is very easy to use and comes complete with full instructions. Suitable for the Model B or Model A with 32K

CASSETTE £26.95
DISK £28.95

Enquire at your local computer store or order direct (Post FREE) from:—

A.C.K. DATA
PCW Dept
21 Salcombe Drive
Redhill
Nottingham NG5 8JF
Tel: (0602) 262498
Dealer enquiries welcome

```

7899 REM CRASH ROUTINE
7900 FOR n=0 TO 21: PRINT AT n,0; INK 0; PAPER 0; OVER 0;"
      ": BEEP 0.5,-30: NEXT n
7901 FOR n=0 TO 30: PRINT AT 9,0; INK 7; PAPER 2; BRIGHT 1; FLASH 1;" YOU CRASHE
D INTO THE GROUND! NightHawk DESTROYED!
7902 BEEP 0.02,20: BEEP 0.02,24: NEXT N: CLS : GO TO 9600
8949 REM MISSILE ROUTINE FOR WHEN YOU EXCEED MAX.RADAR HEIGHT
8950 LET g=INT (SRND)
8951 IF g<2 THEN PRINT AT 6,12; INK 7; PAPER 2; FLASH 0; BRIGHT 1;" missile "fA
T 7,12; INK 7; PAPER 2; BRIGHT 1; FLASH 0;" avoided ": PAUSE 30: PRINT AT 6,12;"
      ": AT 7,12;"
      ": GO TO 140
8952 IF g>=2 THEN BEEP 1,-30: PRINT AT 16,12; INK 7; PAPER 2; BRIGHT 1; FLASH 1
;" HIT ": PRINT AT 21,18; INK 7; BRIGHT 1; FLASH 1; PAPER 1;"100%": PAUSE 30
: GO TO 9400
8999 REM CRASH ROUTINE FOR WHEN NIGHTHAWK RUNS OUT OF FUEL
9000 FOR n=0 TO 21: PRINT AT n,0; INK 0; PAPER 0; OVER 0;"
      ": BEEP 0.5,-30: NEXT n
9001 FOR n=0 TO 30: PRINT AT 9,0; INK 7; PAPER 2; BRIGHT 1; FLASH 1;" NightHawk
HAS RUN OUT OF FUEL MISSION ABORTED
9002 BEEP 0.02,20: BEEP 0.02,24: NEXT N: CLS : GO TO 9600
9101 GO TO 9600
9349 REM CRASH ROUTINE FOR WHEN DAMAGE EXCEEDS 100%
9350 FOR n=0 TO 21: PRINT AT n,0; INK 0; PAPER 0;"
      ": BEEP 0.5,-30: NEXT n
9351 FOR n=0 TO 30: PRINT AT 9,0; INK 7; PAPER 2; FLASH 1; BRIGHT 1;" DAMAGE=100
%.TOTAL LOSS OF CONTROL... NightHawk DESTROYED!
9352 BEEP 0.02,20: BEEP 0.02,24: NEXT n: CLS : GO TO 9600
9399 REM CRASH ROUTINE FOR WHEN DESTROYED BY AN ENEMY MISSILE
9400 FOR n=0 TO 21: PRINT AT n,0; INK 0; PAPER 0; OVER 0;"
      ": BEEP 0.5,-30: NEXT n
9401 FOR n=0 TO 30: PRINT AT 9,0; INK 7; PAPER 2; BRIGHT 1; FLASH 1;" YOU WER
E HIT BY AN ENEMY MISSILE...
      NightHawk DESTROYED.
9402 BEEP 0.02,20: BEEP 0.02,24: NEXT N: CLS : GO TO 9600
9499 REM TITLE ROUTINE...DRAWS "NIGHTHAWK"+HAWK MOTIF
9500 PLOT 1,100: DRAW 0,25: DRAW 3,0: DRAW 7,-22: DRAW 0,22: DRAW 3,0: DRAW 0,-2
5: DRAW -3,0: DRAW -7,22: DRAW 0,-22: DRAW -3,0
9501 PLOT 19,100: DRAW 0,12: DRAW 3,1: DRAW 0,-12: DRAW -3,-1: PLOT 19,117: DRAW
3,1: DRAW 0,2: DRAW -3,-1: DRAW 0,-2
9502 PLOT 27,103: DRAW 0,8: DRAW 5,3: DRAW 10,0: DRAW 0,-30: DRAW -3,-3: DRAW -8
,0: DRAW -3,3: DRAW 0,3: DRAW 3,0: DRAW 0,-3: DRAW 3,-3: DRAW 2,0: DRAW 3,3
9503 DRAW 0,16: DRAW -6,0: DRAW -5,3: PLOT 30,106: DRAW 0,4: DRAW 3,1: DRAW 6,0:
DRAW 0,-8: DRAW -6,0: DRAW -3,1: DRAW 0,2
9504 PLOT 47,100: DRAW 0,20: DRAW 3,1: DRAW 0,-10: DRAW 7,0: DRAW 3,-1: DRAW 0,-
9: DRAW -3,-1: DRAW 0,7: DRAW -7,0: DRAW 0,-6: DRAW -3,-1
9505 PLOT 65,100: DRAW 0,20: DRAW 3,1: DRAW 0,-7: DRAW 5,0: DRAW 0,-2: DRAW -3,-
1: DRAW -1,0: DRAW 0,-8: DRAW 2,0: DRAW 3,1: DRAW 0,-3: DRAW -3,-1: DRAW -5,0
9506 PLOT 252,101: DRAW -3,-1: DRAW -6,8: DRAW 0,-7: DRAW -4,-1: DRAW 0,20: DRAW
4,1: DRAW 0,-8: DRAW 6,4: DRAW 0,-4: DRAW -4,-3: DRAW 7,-8
9507 PLOT 230,100: DRAW 3,15: DRAW -3,0: DRAW -3,-12: DRAW -3,12: DRAW -6,0: DRA
W -3,-12: DRAW -3,12: DRAW -3,0: DRAW 3,-15: DRAW 6,0: DRAW 3,12: DRAW 3,-12: DRA
W 6,0
9508 PLOT 203,100: DRAW 0,16: DRAW -12,0: DRAW -4,-3: DRAW 0,-10: DRAW 4,-3: DRA
W 12,0
9509 PLOT 200,103: DRAW 0,10: DRAW -8,0: DRAW -2,-1: DRAW 0,-8: DRAW 2,-1: DRAW
8,0
9510 PLOT 180,100: DRAW 0,25: DRAW -3,0: DRAW 0,-10: DRAW -8,0: DRAW 0,10: DRAW
-3,0: DRAW 0,-25: DRAW 3,0: DRAW 0,11: DRAW 8,0: DRAW 0,-11: DRAW 3,0
9511 PLOT 145,100: DRAW -3,2: DRAW -1,4: DRAW -1,8: DRAW -2,4: DRAW -3,5: DRAW -
3,2: DRAW -10,0: DRAW -6,-1: DRAW -3,-2: DRAW -2,-1: DRAW -1,-1: DRAW 0,-1: DRAW
2,-4
9512 DRAW 2,-1: DRAW 4,-2: DRAW 2,-1: DRAW 1,-2: DRAW -1,1: DRAW -10,1: DRAW -3,-
-1: DRAW -1,-3: DRAW 1,-1: DRAW -3,5: DRAW -2,3: DRAW 2,1: DRAW 4,2: DRAW 1,2
9513 PLOT 114,117: DRAW 1,2: DRAW 3,1: DRAW 4,1: DRAW 3,0: DRAW 3,-1: PLOT 118,1
20: DRAW 0,-3: DRAW 2,-2: DRAW 2,0: DRAW 2,2: DRAW 1,2
9514 PLOT 122,119: PLOT 116,110: DRAW 2,-4: DRAW -1,-3: DRAW -2,-6
9515 PRINT AT 10,31;"
9516 PRINT AT 13,2; INK 7; BRIGHT 1;"Probably the meanest machine in
the world
9520 INK 2: PLOT 105,155: DRAW 2,1: DRAW 2,1: DRAW 2,1: DRAW 3,4: DRAW 2,1: DRAW
3,0: DRAW 2,1: DRAW 0,2: DRAW 3,0: DRAW 1,-2: DRAW 0,-1: DRAW 2,-3: DRAW 0,-1:
DRAW 7,-1: DRAW 3,4
9521 DRAW 1,1: DRAW 2,0: DRAW -1,-6: DRAW 1,-5: DRAW -2,0: DRAW -3,3: DRAW -11,-
1: DRAW -2,-1: DRAW -8,-1: DRAW -2,-2: DRAW -3,0: DRAW -1,1: DRAW 0,2: DRAW -4,0
: DRAW -2,1
9522 PLOT INK 2;100,165: DRAW INK 2;22,2: PLOT INK 2;123,167: DRAW INK 2;22,
2
9523 REM WAITS FOR KEY PRESS THEN SCROLLS SCREEN
9524 LET a$="Press any key": FOR n=0 TO 7: PRINT AT 20,10; INK n;BEEP 0.01,n
: PAUSE 5: NEXT n
9525 PAUSE 0: FOR n=0 TO 21: LET a$=USR 3280: BEEP 0.001,50: NEXT n
9529 REM ASKS WHETHER INSTRUCTIONS ARE REQUIRED
9530 PRINT AT 9,0; INK 7; PAPER 2; BRIGHT 1;"Press 'I' for Instructions or Pre
ss 'S' to Start the game
9535 POKE 23658,8
9536 IF INKEY$="I" THEN GO TO 9540
9537 IF INKEY$="S" THEN CLS : INK 7: GO TO 30
9538 GO TO 9530
9539 REM BACKGROUND & INSTRUCTIONS
9540 CLS : POKE 23658,0: INK 7: PRINT AT 1,10;"The Setting..."
9545 PRINT AT 3,0; INK 4;"You are the pilot of the Air Force's latest combat
chopper, NightHawk. War has broken out in Europe and yo
ur ground forces are beingpushed back by a surge of enemy tanks.Your mission is
to fly as many sorties as you can before your dwindling fuel stocks run out.
9546 PRINT AT 13,0; INK 2;" THE ENEMY TANKS MUST BE DESTROYED!
9547 PAUSE 1000: CLS
9549 REM INSTRUCTIONS ON CONTROLS
9550 PRINT AT 1,12;"Controls"
9551 PRINT AT 3,0;"Up-Q Down-A
Bank left-O Bank right-P
Increase power-I Decrease power-U
Cannon selection-C Rocket select
ion-R
9552 PRINT AT 13,0;" Crosshair up-7
Crosshair down-6 Crosshair left-5 Crosshair ri
ght-8 Fire-0
Damage review-D Target finder-S
9553 PAUSE 0: CLS : GO TO 30
9599 REM HIGH SCORE TABLE.ASKS FOR PILOT'S NAME,etc
9600 CLS
9601 INPUT "Pilot's name:";g$
9603 IF kill>=0 AND kill<=5 THEN LET scorepos=14: LET y$=q$: LET y=kill
9604 IF kill>=6 AND kill<=10 THEN LET scorepos=12: LET t$=g$: LET t=kill
9605 IF kill>=11 AND kill<=15 THEN LET scorepos=10: LET r$=g$: LET r=kill
9606 IF kill>=16 AND kill<=20 THEN LET scorepos=8: LET e$=g$: LET e=kill
9607 IF kill>=21 AND kill<=25 THEN LET scorepos=6: LET w$=g$: LET w=kill
9608 IF kill>=26 THEN LET scorepos=4: LET q$=g$: LET q=kill
9610 PLOT 78,161: DRAW 0,-11: DRAW 107,0: DRAW 0,11: DRAW -107,0: PRINT AT 2,10;
INK 7; PAPER 2; FLASH 1;"Hi-Kill Table"
9620 PRINT AT 4,5; INK 7; BRIGHT 1;q$;" "
;w$;"
iw

```

PROGRAM FILE

MICROART

SOFTWARE UP TO 40% DISCOUNT

All software for IBM PC and compatibles, but most is also available for other MS-DOS machines, ie APRICOT, HITACHI, SANVO etc. and CPM-80, CPM-86, machines. State computer when ordering

	Our Price		Our Price
dBASE 11	395 237	dBASE 111	550 325
Lotus 123	430 310	Symphony	595 425
Framework	550 325	Pision Exchange	495 375
Delta	495 395	Supercalc 3 v 2	360 259
Wordstar	295 195	Wordstar Professional	399 265
Wordstar 2000	465 310	SAGE Bookkeeper	295 209
SAGE Accountant	495 349	SAGE Payroll	195 145
SAGE Options	145 105	SAGE Chit-Chat	130 95
PULSAR Accts(1 module)	195 152	Retrieve 11	495 359
Multimate v 3.3	455 325	Multipan	190 145
Spotlight	113 81	CrossTalk	162 120
Sideways	54 39	Electric Desk	308 219
Sidekick (Unprotected)	72 56	Sidekick (Protected)	47 37
VolksWriter De Luxe	289 199	Sycoro	595 450
Personal Pearl	190 130	Perfect Writer 11	149 109
Perfect Calc 11	149 109	Perfect Filer 11	149 109
Practibase	85 65	Practiword	85 65
PractiCalc 111	85 65	PractiCalc 111 (bundle)	215 155
KnowledgeMan	414 299	Open Access	450 325
PFS File	115 85	PFS Write	115 85
PFS Report	115 85	PFS Plan	115 85
HarvardProject Manager	376 283	Turbo PASCAL	47 38
MS BASIC Compiler	385 289	MS BASIC Interpreter	340 256
MS Bus Basic Compiler	450 339	MS COBOL Compiler	645 489
MS PASCAL Compiler	295 220	MS Macro Assembler	150 115
MS C Compiler	485 365	MS FORTRAN Compiler	340 256
Norton Utilities v 2.0	70 51	Norton Utilities v.3.0	85 64
DR Assembler plus tools	185 135	Cio	95 85
Disk Doctor	70 51	Menugen	48 38
MS Flight Simulation	65 51	Typing Tutor 111	42 32

COMPUTERS

COMMODORE PC-10 RRP £1675 Our Price ONLY £1475
Fully IBM PC Compatible, with 256kb RAM, 12" mono monitor, 5 expansion slots, dual double sided 360kb floppy disk drives, MS DDS 2 11

COMMODORE PC-10+10 RRP £2895 Our price ONLY £2295
Fully IBM PC Compatible, with 256kb RAM, twin 360K floppy disk drives AND 10mb fixed disk drive, 4 expansion slots, 12" mono monitor, serial & parallel ports

ZENITH Z150 PC RRP £1900 Our price ONLY £1635
The world's best selling IBM PC compatible! 128kb RAM, 2 x 360K disk drives, colour graphics, serial and parallel interfaces, 3rd party maintenance contract. Also available with 320kb RAM at ONLY £1805, or with 10mb Hard Disk at ONLY £2795.

SANVO NBC 775 RRP £2150 Our price ONLY £1795
Fully IBM compatible PORTABLE computer, with built-in colour monitor, 256kb disk drives, MS-DOS 2.11 operating system, 2 expansion slots.

SANVO NBC 550 (Single 160kb disk drive, free S/W) RRP £749 Our price £610

SANVO NBC 555-2 (Double 360kb drives, free S/W) RRP £1390 Our price £1190

ZENITH MONITORS

13" High Res Col	339	12" Amber screen	85
12" Green screen	85	12" Amber (IBM PC)	109
ZEN IBM-PC Colour cable	15	SANVO 80 column green	95

DOT MATRIX PRINTERS

EPSON RX-80 (T) 100cps	219	EPSON RX-80 (F/T) 100cps	249
EPSON RX-100 (F/T) 100cps	365	EPSON FX-80 160cps	375
EPSON FX-100 (F/T) 160cps	475	EPSON LQ-1500 (inc I/F)	950
STAR Gemini 10/FT 120cps	215	STAR Gemini 15 FT 120cps	309
STAR Delta 10 FT 160cps	339	STAR Delta 15 FT 160cps	459
PANASONIC KX-P1091 (IBM)	275	BROTHER HR5 (P or S)	129
BROTHER M1009 Dual I/face	169	BROTHER M1009 (IBM) 50cps	155
BROTHER 2024 LNLQ 160cps	899	NEWBURY DATA DRI 8830	1059

DAISY WHEEL PRINTERS

BROTHER HR15 13cps	325	BROTHER HR25 25cps	635
BROTHER HR35	749	TEC 10/40 40cps	899
CITOH A10/30 30cps	499	EPSON DX-100	385
SILVER REED Exp 400 (P)	223	SILVER REED Exp 400 (S)	255
SILVER REED Exp 500 (P)	268	SILVER REED Exp 500 (P)	430

FULL COMMUNICATIONS PACKAGE

Thorn EMI V21/V23 AUTO ANSWER, AUTO DIAL, modem, cable & SAGE CHIT-CHAT software now available for only £319.00. Normal RRP £399.00

CSU/RODIME WINCHESTER EXTERNAL 5.25" HARD DISK

Complete with cables, host adaptor, manuals and software diskette. For IBM-PC and compatibles, SANVO 550/555, ACT APRICOT, HITACHI etc.

11 MByte Drive	1084	22 MByte Drive	1290
33 MByte Drive	1466	44 MByte Drive	1642
11 MByte Drive/Tape Streamer	1914	22 MByte Drive/Tape Streamer	2173
33 MByte Drive/Tape Streamer	2328	44 MByte Drive/Tape Streamer	2564

FLOPPY DISKS

SPECIAL OFFER. Unbranded but top quality Diskettes, manufactured by a major company and used as original equipment by many Software Houses. In boxes of 10, complete with HUB RING, SLEEVE and labels. Each disk has a LIFETIME GUARANTEE. HIGHLY RECOMMENDED. 5.25"

	1 box	2-4	5-9	10+
SS/DD 48 tpi	13.50	12.90	11.90	11.00
DS/DD 48 tpi	16.50	15.90	14.90	13.90
SS/DD 96 tpi	17.50	16.90	15.90	14.90
DS/DD 96 tpi	18.50	17.90	16.90	15.90

Verbatim DATALIFE 5.25"

SS/DD 48 tpi	18.90	17.50	16.90	15.90
DS/DD 48 tpi	22.90	21.50	20.75	19.50
SS/DD 96 tpi	22.90	21.50	20.75	19.50
DS/DD 96 tpi	27.50	26.50	25.50	24.50

BASF or 3M 5.25"

SS/DD 48 tpi	16.50	16.20	15.80	15.20
DS/DD 48 tpi	21.50	20.75	19.90	19.50
SS/DD 96 tpi	22.50	21.75	20.90	20.50
DS/DD 96 tpi	25.00	24.50	23.50	23.00

- When comparing prices, note that Carnage is FREE on ALL items, incl Courier service for Computers, Printers and most software.
- Official orders from Government Depts & Times top 1000 welcome, otherwise strictly cash with order, please. EXPORT specialists.
- FAST DELIVERY, normally 48 hours, Callers by appointment please.
- TELEPHONE 01-881 9240 for advice, and complete lists
- ALL PRICES EXCLUDE VAT. PLEASE ADD 15% to total cost of order.

ACL ASHLEY COMPUTERS LTD
42 Harefield Avenue, Cheam, Surrey SM2 7NE



BBC Patience

by Pete Telfer

This is the standard game of patience, faithfully transferred to the BBC Micro. As it disables the BREAK key, you are strongly advised to save the program before running it—you won't be able to afterwards. If you don't have a disk system, don't type in lines 60 to 110 of the second part. The first part sets up graphics and display instructions.

```

10 REM *****
20 REM * Program 1 *
30 REM * Loader, Inst. & Graphics *
40 REM * (c)PyroSoft(Pete Telfer *
50 REM * (c)1985 *
60 REM *****
70 *FX200,2
80
90
100
110 ONERRORRUN
120 MODE7:PRINT
130 PRINT " ";CHR#131;CHR#157;SPC(32);CHR#156
140 FORCZ=1 TO3:PRINT " ";CHR#131;CHR#157;CHR#148;CHR#154;:FORAZ=1 TO2B:READBZ
:PRINTCHR#BZ;:NEXT:PRINT " ";CHR#156:NEXT
150 PRINT " ";CHR#131;CHR#157;SPC(32);CHR#156
160 FORCZ=1 TO2:PRINTCHR#146 CHR#154 " ";:FORAZ=1 TO27:READBZ:PRINTCHR#BZ;:
NEXT:PRINT:NEXT
170 PRINT
180 FORCZ=1 TO3:PRINTCHR#145 CHR#154;:FORAZ=1 TO37:READBZ:PRINTCHR#BZ;:NEXT:PR
INT:NEXT
190 PRINTSPC(14)"INSTRUCTIONS"SPC(14)"-----":VDU28,0,24,39,15:PRINT
200 PRINTCHR#141"Do You Wish To See The Instructions ?"
210 PRINTCHR#141"Do You Wish To See The Instructions ?"
220 VDU23,222,68,238,254,254,124,124,56,16
230 VDU23,223,16,56,124,124,254,254,238,84
240 VDU23,224,0,16,56,124,254,124,56,16
250 VDU23,225,0,56,56,16,214,254,214,16
260 VDU23,226,0,34,101,37,37,37,114
270 REPEAT:K$=GET$:UNTILK$="Y"OR K$="N"
280 IFK$="N"BOT0670
290 CLS:RESTORE480
300 FORAZ=1 TO35:READA$:IFA$="#" PRINT:NEXT
310 FORBZ=1 TOLENA$:B$=MID$(A$,BZ,1)
320 IFB$=" " PRINT " ":GOTO340
330 PRINTB$:SOUND1,-10,20,1:W=INKEY(10)
340 NEXT:PRINT:NEXT
350 PRINTCHR#141 CHR#132" Do You Wish To See Again"
360 PRINTCHR#141 CHR#132" Do You Wish To See Again"
370 REPEAT:K$=GET$:UNTILK$="Y"OR K$="N"
380 IFK$="N"BOT0670ELSEGOTO290
390
400 DATA255,175,244,224,254,253,176,175,255,175,170,239,191,165,255,175,175,23
4,245,234,181,248,191,244,234,191,175,165
410 DATA255,252,167,234,189,238,181,32,255,32,234,181,32,255,175,165,234,19
1,255,181,255,32,32,234,191,175,32
420 DATA255,32,32,234,181,234,181,32,255,32,232,254,253,180,255,252,252,234,18
1,234,181,171,253,167,234,253,252,180
430 DATA154,96,36,54,96,52,119,115,36,117,112,53,119,115,36,96,55,33,54,96,36,1
17,112,53,96,55,33
440 DATA101,112,36,101,112,37,53,32,32,32,53,32,53,34,52,112,117,48,101,115,37
,53,32,53,32,53,32
450 DATA255,175,244,234,191,175,165,175,234,191,175,165,32,170,175,255
,175,165,255,175,175,234,181,32,32,255,175,175,234,191,175,165,255,175,244
460 DATA255,175,161,234,183,161,32,32,255,32,234,183,161,32,32,32,32,255,32,32
,255,163,32,234,181,32,32,255,163,32,234,183,161,32,255,247,161
470 DATA175,32,32,170,175,175,165,32,175,32,170,175,175,165,32,32,175,32,32
,175,175,170,175,175,165,175,32,32,170,175,175,165,175,162,173
480 DATA"OBJECT OF THE GAME
490 DATA"Move All The Cards From The Seven Decks And The Twist Pack To F
orm Four New Decks (Hearts, Spades, Diamonds And Clubs) and By Moving Cards
Around"
500 DATA"The Different Decks. The Only Valid Moves Are:";"#";"1.Move A Red
Card (Hearts & Diamonds) To A Black Card (Clubs & Spades) Whose"
510 DATA" Face Value Is One Less Than The Value Of The Black Card.";"#"
520 DATA"2.Move A Black Card (Clubs & Spades) To A Red Card (Hearts & Diamon
d) Whose Face Value Is One Less Than The Value Of The Red Card.";"#"
530 DATA"3.Move A Card To One Of The New Decks."
540 DATA"
-----"
550 DATA"1.To Turn The Next Card Over From The Deck (To Twist) Hit 'RETURN
"
560 DATA"2.To Move A Card From One Deck To Another First Type In The V
alue Of The Card To Be Moved Then Its Suit."
570 DATA" Next Type The Value Of The Card It's To Go Next To Then That Car
ds Value.";"#"
580 DATA" N.B. To Move A King Type 'K' To Move A Queen Type '
Q' To Move A Jack Type 'J' To Move A Ten Type '
T' To Move An Ace Type 'A';"#"
590 DATA"3.To Move A Card Out From The Twist Pack Or From One Of The Decks To
One Of The Four Suits (Hearts,Spades,Diamonds Or Clubs)."
600 DATA" First Type In The Value Of The Card To Be Moved Then Its Suit F
ollowed By Hitting 'RETURN'.";"#"
610 DATA" N.B. The First Card You Move To The Suit Decks MUST BE AN
ACE Followed By Their Next
In Value.";"#"
620 DATA"4.If One Of The Seven Decks Is Cleared Of All Its Cards ie.None On
Display And None Hidden."
630 DATA" You May Move Any Available KING To That Space By Typing 'K' Th
en The Suit Of The King Followed By 'RETURN'.";"#"
640 DATA"5.When All The Cards Have Been Moved To The Suit Decks The Game Is
Over And You Will Be Told The Time Taken For The Game And The No. Of Err

```

Superbrains



MICROMODS LTD
 53 Acton Road
 Long Eaton
 Nottingham NG10 1FR
 Tel: 0602 724264

WHY PAY MORE??

FERRANTI ADVANCE 860

IBM PC compatible micro with: integrated Spreadsheet, Wordprocessor, and Database and BASIC A. Used by many organisations including British Steel and British Rail.

ONLY £1205

including monitor and box of disks and paper.

Ferranti 860 XT, as above but with 10 megabyte hard disk
 £2045

COMPLETE BUSINESS SYSTEM

Ferranti 860 Micro, Printer and Monitor. SAGE Accounts Software. Integrated Spreadsheet, Wordprocessor, & Database and BASIC A. Box of Disks and Paper.

ONLY £1595

Advant 86B still available for limited period from:
 £900

Taxan/Canon ribbons £5.80

Other software at very competitive prices.

Leicester Computer Systems

26 Brookfield Way, Kibworth
 Leicester LE8 0SA

Tel: Leicester (0533) 541030

HEMEL COMPUTER CENTRE LTD.

For fast reliable repair service, send your 16/48K Spectrum computer to us. We will repair and return for

£20 + £1.60 p&p.

Also BBC, Commodore, Atari and Dragon service.

Three months warranty on all repairs.

Hemel Computer Centre Ltd.
 52 High Street,
 Hemel Hempstead,
 Herts HP1 1AF.
 Tel: 0442 212436

```
650 DATA"6.At Any Time You May Quit The Game By Pressing 'ESCAPE'."
660 DATA"7.You May Only Go Through The Twist Pack Three Times.After Which
The Game Is Over."
670 CLS
680 CHAIN"CARD2"
```

```
10 REM (c)PyroSoft-Feb,1985
20
30
31 _ONERRORRUN
40 *FX200,2
50 IF PAGE=£E00 THEN110
60 *K.0 *FX3,00M CLS:*FX3,60M SD.1,-15,150,30M *T.0M DZ=PAGE-£E00: FOR LZ=PAG
E I0 TOP STEP 4:!(LZ-DZ)=!LZ: NEXT:PAGE=£E00 0M OLD 0M DEL.50,1000M RUN0M
70 *FX 138,0
80 PRINT"CHR$141"PRESSfoTO RUN""CHR$141"PRESSfoTO RUN";
90 *FX3,6
100 END
110 *FX3,0
130 MODEL:VDU19,128,4,0,0,0;DIMP$(8),S$(3),D$(6):PROCSHU:VDU28,1,30,38,27:COL
DUR129:TIME=0:IVZ=0:ERZ=1
140
150 _ONERRORGOTO2050
160 *FX21,0
170 IFERZ>3 GOTO2100
180 VDU4:CLS:PRINT"SPC(7)"Press 'RETURN' To Twist""SPC(12)"Dr Move ? To ?"
190 IFLENS(0)=26ANDLNS$(1)=26ANDLNS$(2)=26ANDLNS$(3)=26 GOTO1990
200 M$="" : REPEAT:K$=GET$:UNTILK$="K"OR"K$="D"OR"K$="J"OR"K$="T"OR"K$="A"OR"VALK$>1
DRASE(K$)=13
210 CLS:PRINT"" :!IFASC(K$)=13 PRINTSPC(13);!* TWIST *!:PROCT:FORWZ=0TO3000:N
E1:GOTO160
220 *FX21,0
230 M$=M$+K$:PROCP1:REPEAT:K$=GET$:UNTILK$="H"OR"K$="S"OR"K$="D"OR"K$="C":PROCP2:
PRINT" To ":M$=M$+K$
240 *FX21,0
250 REPEAT:K$=GET$:UNTILK$="K"OR"K$="Q"OR"K$="J"OR"K$="T"OR"K$="A"OR"VALK$>1 DRASC(
K$)=13
260 IFASC(K$)=13 PRINTCHR$8;CHR$8;CHR$8;"Moved Out":PROCo:FORWZ=0 TO2000:NEXT:
GOTO160
270 PROCP1:M$=M$+K$
280 *FX21,0
290 REPEAT:K$=GET$:UNTILK$="H"OR"K$="S"OR"K$="D"OR"K$="C":PROCP2:M$=M$+K$:PROCMov
e:WZ=INKEY(50):GOTO160
300 END
310
320 DEFPROCSHU
330 VDUS:MOVE390,990:GC0L0,3:PRINT"(c)Pyrosoft 1985":MOVE395,995:GC0L0,1:PRINT
"(c)Pyrosoft 1985"
340 C$="AH2H3H4H5H6H7H8H9HTHJHQHKHAS2S3S4S5S6S7S8S9STSJSQSKSAD2D3D4D5D6D7D8D9D
TDJDDQKDAC2C3C4C5C6C7C8C9CTCJCQCKC"
350 FORAZ=1TO2
360 D$="" : REPEAT:LZ=LEN(C$)-1:IFLZ=1 D$=D$+C$:C$="" :GOTO4000
370 RZ=RND(LZ)
380 T$=MID$(C$,RZ,1):IFT$="H"ORT$="S"ORT$="D"ORT$="C" RZ=RZ+1:GOTO380
390 D$=D$+T$+MID$(C$,RZ+1,1):C$=LEFT$(C$,RZ-1)+RIGHT$(C$,LZ-RZ)
400 UNTILC$=""
410 C$=D$:NEXT:D$=C$:C$=""
420 XZ=20:LZ=1:FORDZ=1 TO7:FORAZ=DXT07:T$=MID$(D$,LZ,2):LZ=LZ+2:IFAZ=DZ YZ=930
ELSEYZ=950
430 IFAZ=DZ PROCCA(0):PROCSOU ELSEPROCCA(1)
440 IFAZ=DZ D$(AZ-1)=T$ELSEP$(AZ-1)=P$(AZ-1)+T$
450 YZ=XZ+128:NEXT:PROCX:NEXT
460 XZ=1000:YZ=500:REPEAT:T$=MID$(D$,LZ,2):LZ=LZ+2:P$(7)=P$(7)+T$:UNTILLZ=105:
PROCCA(1):D$="" :ENDPROC
470
480 DEFPROCCA(FZ)
490 IFFZ=1 GC0L0,1
500 IFFZ=0 GC0L0,3
510 IFFZ=10 GC0L0,0
520 MOVEXZ,YZ:MOVEXZ+115,YZ:PLOT85,XZ+115,YZ-150:MOVEXZ,YZ:PLOT85,XZ,YZ-150
530 IFFZ=1 GC0L0,2:FORBZ=XZ+10 TOXZ+109 STEP 12:MOVEBZ,YZ:DRAWBZ,YZ-150:NEXT
540 IFFZ<>0 ENDPROC
550 T1$=LEFT$(T$,1):T2$=RIGHT$(T$,1)
560 IFT2$="H"ORT2$="D" GC0L0,1ELSEGC0L0,0
570 IFT1$="T" T1$=CHR$226
580 IFT2$="H" T2$=CHR$222
590 IFT2$="S" T2$=CHR$223
600 IFT2$="D" T2$=CHR$224
610 IFT2$="C" T2$=CHR$225
620 T3$=T1$+T2$+CHR$10+CHR$10+CHR$10+CHR$10+CHR$10+CHR$10+T2$+T1$
630 VDUS:MOVEXZ+10,YZ-12:PRINTT3$:MOVEXZ,YZ:GC0L0,0:DRAWXZ+115,YZ:T3$=""
640 ENDPROC
650
660 DEFPROCT
670 LZ=LEN(P$(7))
680 IFLZ=0 AND P$(8)="" CLS:PRINT"SPC(10);""NO CARDS LEFT !!!":FORAZ=1 TO4:SDUN
D1,-7,50,2:FORWZ=1 TO1000:NEXT:NEXT:FORWZ=1 TO2000:NEXT:ENDPROC
690 IFLZ=2 XZ=1000:YZ=500:PROCCA(10)
700 IFLZ=48 XZ=1000:YZ=320:PROCCA(10):WZ=INKEY(20):YZ=500:PROCCA(1)
710 IFLZ=0:P$(7)=P$(8):P$(8)="" :XZ=1000:YZ=320:PROCCA(10):YZ=500:PROCCA(1):ERZ
=ERZ+1:GOTO670
720 T$=RIGHT$(P$(7),2):XZ=1000:YZ=320:PROCCA(0):P$(8)=T$+P$(8):P$(7)=LEFT$(P$(
7),LZ-2):PROCSOU
730 ENDPROC
740
750 DEFPROCo
760 PROCF1(M$):D1Z=DZ:1FFDZ=0 GOTO1710
770 T1$=RIGHT$(M$,1):T2$=LEFT$(M$,1):PROCS:IFT2$="K"ANDOKZ=0 PROCoK:ENDPROC
780 IFDZ=0ANDT2$<>"K" GOTO1710
790 IFDZ<B LZ=LEN(D$(DX))-1:IFCZ<>LZ GOTO1710
800 IFDZ=B GOTO840
810 IFLEND$(DZ)=2 D$(DZ)="" :PROCTOP(DZ):GOTO830
820 D$(DZ)=LEFT$(D$(DZ),LEND$(DZ)-2):T$=RIGHT$(D$(DZ),2):DZ=D1Z:PROCX:YZ=1005-
(25*CZ)-50:PROCCA(10):YZ=YZ+50:PROCCA(0)
830 GOTO860
840 IFLENP$(B)=2 P$(8)="" :XZ=1000:YZ=320:PROCCA(10):GOTO860
850 P$(8)=RIGHT$(P$(8),LENP$(B)-2):T$=LEFT$(P$(8),2):XZ=1000:YZ=320:PROCCA(0)
860 T1$=RIGHT$(M$,1):T2$=LEFT$(M$,1)
870 IFT1$="H"ORT1$="S" XZ=1000 ELSEXZ=1150
880 IFT1$="S"ORT1$="D" YZ=750 ELSEYZ=950
890 N$="" :T$=M$:PROCCA(0):S$(PZ)=S$(PZ)+M$:PROCSOU:ENDPROC
900
910 DEFPROCoK
920 OKZ=10:FDRAZ=6TUOSTEP-1:IFP$(AZ)=""ANDD$(AZ)="" OKZ=AZ
930 NEXT
940 IFOKZ>6 GOTO1710
950 D1Z=DZ:IFDZ=8 GOTO990
960 PROCX:PROCCLEAR(930):M0$=D$(DZ):D$(DZ)="" :D$(OKZ)=M0$:YZ=930:DZ=OKZ:PROCX:
```

PROGRAM FILE

```
FORAZ=1 IULENNU$STEP2:T$=MID$(M$,AZ,2):PROCCA(O):Y%Y%-50:PROCSOU:NEXT
970 PROCDTOP(D1%)
980 ENDFPROC
990 X%=1000:Y%=320:IFLENP$(B)=2 O$(OKZ)=P$(B):P$(B)="" :PROCCA(10):GOTO1010
1000 O$(OKZ)=LEFT$(P$(B),2):P$(B)=RIGHT$(P$(B),LENP$(B)-2):T%=LEFT$(P$(B),2):PR
ROCCA(O)
1010 T%=O$(OKZ):Y%=930:DZ=OKZ:PROCX:PROCCA(O):PROCSOU
1020 ENDFPROC
1030
1040 DEFPROCmove
1050 T1%=MID$(M$,2,1):T3%=MID$(M$,1,1):T2%=MID$(M$,4,1):T4%=MID$(M$,3,1)
1060 EZ=O:IFT1%="H"ANDT2%="C" EZ=1
1070 IFT1%="H"ANDT2%="S" EZ=1
1080 IFT1%="D"ANDT2%="S" EZ=1
1090 IFT1%="D"ANDT2%="C" EZ=1
1100 IFT1%="C"ANDT2%="H" EZ=1
1110 IFT1%="C"ANDT2%="D" EZ=1
1120 IFT1%="S"ANDT2%="D" EZ=1
1130 IFT1%="S"ANDT2%="H" EZ=1
1140 IFT3%="1"ANDT4%<>"J" EZ=O
1150 IFT3%="J"ANDT4%<>"Q" EZ=O
1160 IFT3%="Q"ANDT4%<>"K" EZ=O
1170 IFT3%="9"ANDT4%<>"T" EZ=O
1180 IFEX=O GOTO1710
1190 IFT3%="9"ORFT3%="1"ORT3%="J"ORT3%="Q" GOTO1220
1200 V1%=VAL(I3%):V2%=VAL(I4%)
1210 IFV2%>V1%+1 GOTO1710
1220 15%=LEF1$(M$,2):T6%=RIGHT$(M$,2):PROCFI(T5%):IFFOZ=O GOTO1710
1230 D1%=DZ:C1%=CZ:PROCFI(I6%):IFFOZ=O GOTO1710
1240 D2%=DZ:L2%=CZ:IFCZ>1<LENU$(DZ) GOTO1710
1250 IFDZ=8 GOTO1710
1260 IFD1%=8 PROCMoveB:ENDPROC
1270 DZ=D1Z:PROCX:Y%=980-(C1Z*25)-25:PROCCLEAR(Y%):C3Z=LENO$(D1%):C3Z=C3Z-C1Z+1
MO$=RIGHT$(O$(D1%),C3Z):DZ=D2Z:PROCX:Y%=905-(C2Z*25)
1280 FORAZ=1 IULENNU$STEP2:T$=MID$(M$,AZ,2):PROCCA(O):Y%Y%-50:O$(D2Z)=O$(D2Z)
+1$:PROCSOU:NEXT
1290 IFC3Z=LENO$(D1Z) O$(D1Z)="" :PROCDTOP(D1%):ENDPROC
1300 O$(D1Z)=LEF1$(O$(D1Z),LENO$(D1Z)-C3Z):T$=RIGHT$(O$(D1Z),2):DZ=D1Z:PROCX:Y%
=980-(LENO$(D1Z)*25):PROCCA(O):ENDPROC
1310
1320 DEFPROCmoveB
1330 X%=1000:Y%=320:PROCCA(10):T%=LEFT$(P$(B),2):DZ=D2Z:PROCX:Y%=905-(C2Z*25):P
ROCCA(O):O$(D2Z)=O$(D2Z)+T$
1340 P$(B)=RIGHT$(P$(B),LEN P$(B)-2)
1350 PROCSOU:IFP$(B)="" ENDFPROC
1360 X%=1000:Y%=320:T%=LEFT$(P$(B),2):PROCCA(O):ENDPROC
1370
1380 DEFPROCFI(CA%)
1390 FOZ=O:DZ=O
1400 IFDZ=7 GOTO1460
1410 LZ=LEN(O$(DZ)):CZ=1
1420 IFLZ=O DZ=DZ+1:GOTO1400
1430 I1%=MID$(O$(DZ),CZ,2)
1440 IFT1%="CA" FOZ=1:ENDPROC
1450 LZ=LZ-2:CZ=CZ+2:GOTO1420
1460 DZ=B
1470 LZ=LENP$(DZ)
1480 IFLZ=O ENDFPROC
1490 I1%=LEF1$(P$(DZ),2)
1500 IFT1%="CA" FOZ=1
1510 ENDFPROC
1520
1530 DEFPROCc
1540 OKZ=O:NDZ=-1
1550 IFT1%="H" TLZ=LEN(S$(O)):PZ=O
1560 IFT1%="S" TLZ=LEN(S$(1)):PZ=1
1570 IFT1%="D" TLZ=LEN(S$(2)):PZ=2
1580 IFT1%="C" TLZ=LEN(S$(3)):PZ=3
1590 IFTLZ=OANDT2%<>"A" ENDFPROC
1600 T3%=MID$(S$(PZ),TLZ-1,1)
1610 TVZ=VAL(I3%):VZ=VAL(I2%):IFTVZ=VZ-1 OKZ=1
1620 IFT3%="9"ANDT2%="T" OKZ=1
1630 IFT3%="1"ANDT2%="J" OKZ=1
1640 IFT3%="J"ANDT2%="Q" OKZ=1
1650 IFT3%="Q"ANDT2%="K" OKZ=1
1660 IFT3%="A"ANDT2%="2" OKZ=1
1670 IFTLZ=OANDT2%="A" OKZ=1
1680 VZ=VAL(I2%):IFTVZ=VZ-1 OKZ=1
1690 ENDFPROC
1700
1710 CLS:PRINT TAB(13):"INVALID MOVE*":SOUND1,-7,10,7:SOUND1,-7,0,7:WZ=INKEY(2
50):IVZ=IVZ+1:ENDPROC
1720 DEFPROCP1
1730 IFK$="T" PRINT"10";
1740 IFK$="A" PRINT"ACE";
1750 IFK$="J" PRINT"JACK";
1760 IFK$="D" PRINT"QUEEN";
1770 IFK$="K" PRINT"KING";
1780 IFK$<>"I"ANDK$<>"J"ANDK$<>"Q"ANDK$<>"K"ANDK$<>"A" PRINTK$;
1790 PRINT Of "":SOUND1,-7,200,2:ENDPROC
1800
1810 DEFPROCP2
1820 IFK$="H" PRINT"HEARTS";
1830 IFK$="S" PRINT"SPADES";
1840 IFK$="D" PRINT"DIAMONDS";
1850 IFK$="C" PRINT"CLUBS";
1860 SOUND1,-7,200,2:ENDPROC
1870
1880 DEFPROCX:XZ=20+128*DZ:ENDPROC
1890
1900 DEFPROCDTOP(deckZ)
1910 DZ=deckZ:PRUCX
1920 IFO$(DZ)=""ANDP$(DZ)="" YZ=930:PROCCA(10):ENDPROC
1930 IFLENP$(DZ)=2 O$(DZ)=P$(DZ):T%=P$(DZ):YZ=950:PROCCA(10):YZ=930:PROCCA(O):P
$(DZ)="" :ENDPROC
1940 T%=LEF1$(P$(DZ),2):O$(DZ)=T$:P$(DZ)=RIGHT$(P$(DZ),LENP$(DZ)-2):YZ=930:PRO
CA(O):ENDPROC
1950
1960 DEFPROCCLEAR(top):GCOLD,O:MOVEX,top:MOVEX+115,top:PLOT85,X+115,160:MOVE
X,top:PLOT85,X,160:ENDPROC
1970
1980 REMWIN
1990 TZ=TIME/100:CLG:XZ=200:FORAZ=O 103:YZ=930:FORBZ=1 TO13:SOUND1,-10,BZ*AZ*2,
1:T$=RIGHT$(S$(AZ),2):PROCCA(O):S$(AZ)=LEFT$(S$(AZ),LENS$(AZ)-2):YZ=YZ-50:NEXT:X
Z=XZ+250:NEXT
2000
2010 VDU4:CLS:PRINT"Congratulations You Have completed"" The Deck. ";
2020 HZ=17/3600:TZ=TZ-(HZ*3600):MZ=TZ/60:TZ=TZ-(MZ*60)
2030 PRINT"Time Taken:"MZ;"mins.":TZ;"secs.":TZ:" You Made ";IVZ;" Mistakes"SPC
(B);"Play Again (Y/N)":GOTO2120
2050 IFERR<>17 REPORT:PRINT"AT ";ERL:ONERROROFF:STOP
2060 VDU4:CLS:PRINT" Do You Really Want To Quit (Y/N)";
2070 *FX21,0
2080 REPEAT:K$=GET$:UNTILK$="Y"ORK$="N":IFK$="Y" PRINT" YES":GOTO2100 ELSEGOTO1
50
```

MICROMART

COMMODORE PC10+10

Fully IBM XT
Compatible
10MB HARD
DISK



Commodore PC10+10 - with twin 360kb floppy drives, PLUS internally mounted RODIME 10mb Winchester Hard Disk Drive. 256kb RAM, 12" non-glare phosphor green monitor, parallel and RS232 ports, 4 expansion slots etc. Full 12 months warranty.

ONLY £2,295

inc. carriage, but plus VAT.

The best value in PC's today.

ASHLEY ■ COMPUTERS ■ LTD



42 Harefield Avenue,
Cheam, Surrey SM2 7NE.
Tel: 01-661 9240.

SPIDER REAL-TIME CONTROL FOR THE BBC MICRO



Look out for the SPIDER
SPIDER — stamps out I/O bugs
£65.00 including VAT

Here's what you get:

- Additional BASIC commands — which can be safely mixed with existing BASIC keywords.
- Invoke BASIC PROCs from function keys or by external events.
- Run up to 8 independent countdown timers.
- The SPIDER is a powerful combination of RAM and ROM mounted on a butterfly board — it leaves the Beeb's memory intact.
- It's easy to install with no soldering required — and a comprehensive manual is supplied.

A breakthrough in ease-of-use for all Control Applications

Send now for our informative leaflet — you'll be surprised at how powerful a Spider can be!

PAUL FRAY LTD

Willowcroft, Histon Road, Cambridge CB4 3JD
Telephone: (0223) 66529



ROM SOFTWARE FOR
THE AMSTRAD CPC 464
FULFILLS THE PROMISE OF YOUR
AMSTRAD

SUPERPOWER ROM-CARD

— 7 Sockets for 8K or 16K eproms (external cased unit with bus extension) £39.95.

SUPERPOWER ROM-BASED SOFTWARE

Disk User's Utilities • Mailing List/Club Membership • Programmer's Toolbox • Assembler/Disassembler/MC Code Monitor • All £39.95 each.

Word Processor, Database, Spreadsheet, Graphics/Statistics — With Data Interchange. Prices to be announced. Available Aug./Sept.

Order today. Phone 0532 434006 or by mail order from MicroPower Ltd., Sheepscar House, Sheepscar Street South, Leeds LS7 1AD. P&P 95p. Access/Visa.



Apricot F1 + Supercalc + Superwriter	£999
Amstrad 664 (green)	£294
Amstrad 664 (colour)	£390
Tatung Einstein TC01	£299
Includes Database + WP + Logo + BBC Basic + Home Budget	
Atari 800XL + 1010 Rec + s/w	£113
Kaga KP810 Printer	£266
Quendata dwp1101 Daisywheel	£256
Brother M1009 d/m Printer	£156
Brother EP44 Printer/typewriter	£176
Seikosha GP100A d/m Printer	£130
Tatung TM01 14" Colour monitor	£159
Tatung TM80 12" Green monitor	£78
Decca DN1491 TV/monitor	£173
Repairs Spectrum	£18.50
Repairs BBC + Commodore	£28

Please enclose cheque with order including + 15% VAT + £5 P&P

ACCESS/VISA WELCOMED

1A QUEENS ROAD, NUNEATON
WARWICKSHIRE CV11 5JS
Tel: (0203) 382049

TOP QUALITY FLOPPIES AT WHOLESALE PRICES

COST PER DISK

	1-9	10-50	51+
SS/DD	1.25	1.15	1.10
DS/DD	1.65	1.55	1.50
SS/QD	1.65	1.55	1.50
DS/QD	1.95	1.85	1.80

PRICES INCLUDE VAT
POST & PACKAGING FREE

Orders taken for any quantity, simply use price bands for cost per disk and multiply by number required

Cheque with order please

HOLLBARN LTD

8 Alexander Road, Stotfold
Hitchin, Herts
Tel: 0594 81618

INSURE YOUR COMPUTER

Impact damage, Fire & Theft insurance for your Computer Equipment

For up to £3,000 cover	£18 pa
For £3,000 to £5,000 cover	£30
For £10,000 cover	£50

FOR DETAILS:

K.G.J. Insurance Brokers Ltd

6 Hagley Road, STOURBRIDGE, West Midlands
DY8 1QG

Tel: (0384) 390909

```

2090 DEFPROCSOU:SOUND0,-7,5,1=W:INKEY(10):ENDPROC
2100 VDU4:CLS:PRINT'SPC(15)"GAME OVER":FORA%:=1TO6:PROCSOU:NEXT:FORW:=1TO2000:NEXT
T
2110 CLS:PRINT'SPC(10)"Play Again (Y/N)";
2120 #FX21,0
2130 REPEAT:K$=GET$:UNTILK$="Y"OR#$="N":IFK$="Y" RUN
2140 CALL !-4
    
```



Logo Database

by Alan Mynett

The procedures listed here allow the implementation of a simple database and suggest how Logo could be used for serious applications. Although written in Sinclair Logo, this is similar enough to the LCS/SOLI Logos that it should run on other machines with minor modifications.

The whole package supports a number of database functions, and has an 'intelligent' HELP facility which prints out the functions currently available in the machine. Due to memory space being limited, if some of the functions are not needed, then a version of the database could be saved without these functions to leave more room for data.

Notes on the procedures are given below, grouped according to function. HELP — the subprocedure MENU uses the primitive DEFINEDP to see whether a calling procedure is present or not. The procedures used by this command are HELP, MENU and PRINTBRIGHT.

SETUP — this requires a single Logo word for input. When called, the subprocedure GETLIST constructs the fieldlist for the database. The procedures used for this command are SETUP and GETLIST.

ADD — this group of procedures adds records to the database. Each record is held as a list of lists. There is no limit other than memory size as to the number of characters in a field. The new record is inserted into the database by the ASCII order of its first field. The subprocedure GTR? compares two Logo words and indicates whether the first is 'greater' than the second. The

procedures in this group are ADD, INSERT, GETDATA, GTR?, SPACE, FINISH? and READWORD.

FIND — this command searches the database and prints out any record containing all the entries specified. The procedure GETLIST is used to compile the list of items to be searched for. The procedures in this group are FIND, SEARCHALL, SEARCHLIST, ANDALL and PRINTRECORD.

PRINTALL — this command prints out all the records in order. It consists only of the procedure PRINTALL.

RECORD — this command takes a number as input and prints out that record. It consists only of the procedure RECORD.

DELETE — this takes the number of a file as input and then deletes that file. The two procedures DELETE and WIPE make up this command.

SAVEFILE — there is no direct way of saving just the variables in Sinclair Logo. This can be achieved by using the DEFINE procedure to set up a dummy procedure using the variables holding the fieldlist and file. Once defined, this procedure called FILE can be saved as usual. Note that most Logos do not allow the saving of a single global variable. The command only uses the procedure SAVEFILE.

LOADFILE — this loads in a previously saved database file by loading in the dummy FILE and 'unpacking' it, using the TEXT primitive to generate the file and fieldlist. It consists only of the procedure LOADFILE.

```

?
TO SEARCHLIST
CT PRINTBRIGHT [FIND] PR [ ]
PRINT [TYPE THE SEARCH ITEMS] PR [PRESS ENTER AFTER EACH ITEM] PR CENTER # TO ST
OP]
OP GETLIST
END

TO ANDALL :LIST :INLIST
IF EMPTY? :LIST [OP "TRUE]
IF NOT MEMBER? FIRST :LIST :INLIST [OP "FALSE]
OP ANDALL BF :LIST :INLIST
END

TO PRINTRECORD :L1 :L2
IF EMPTY? :L1 [PR [ ] STOP]
PRINT FIRST :L1
REPEAT 5 [TYPE CHAR 32]
PRINT FIRST :L2
PRINTRECORD BF :L1 BF :L2
END

TO SEARCHALL :ITEM :DBASE
MAKE "RECORD :RECORD + 1
IF :DBASE = [ ] [STOP]
IF ANDALL :ITEM FIRST :DBASE [PRINTBRIGHT SE [RECORD NUMBER] :RECORD PRINTRECORD
:FIELDS FIRST :DBASE IF FINISH? [TOPLEVEL]]
SEARCHALL :ITEM BF :DBASE
END

TO READWORD
MAKE "INPUT RL
IF :INPUT = [ ] [OP " ]
OP FIRST :INPUT
END
    
```



```

TO FINISH?
PRINT []
PRINTBRIGHT [STOP to end:ENTER for next]
IF READWORD = "STOP [OP "TRUE]
OP "FALSE
END

TO GTR? :W1 :W2
IF OR EMPTY? :W1 EMPTY? :W2 [IF EMPTY? :W1 [OP "FALSE] [OP "TRUE]]
IF NOT ( ASCII ( FIRST :W1 ) ) = ( ASCII ( FIRST :W2 ) ) [OP ( ASCII ( FIRST :W1
) ) > ( ASCII ( FIRST :W2 ) ) ]
OP GTR? BF :W1 BF :W2
END

TO SPACE
RECYCLE
PRINT ( SE "SPACE= NODES "Nodes )
END

TO GETDATA :FIELDS
PRINT []
IF :FIELDS = [] [OP []]
TYPE SE FIRST :FIELDS CHAR 32
MAKE "INPUT RL
IF :INPUT = [] [MAKE "INPUT [* * *]]
OP FPUT :INPUT GETDATA BF :FIELDS
END

TO INSERT :INPUT :INLIST
IF EMPTY? :INLIST [OP LPUT :INPUT :INLIST]
IF GTR? FIRST :INPUT FIRST :INLIST [OP FPUT FIRST :INLIST INSERT :INPUT BF
:INLIST]
OP FPUT :INPUT :INLIST
END

TO GETLIST
MAKE "INPUT RL
IF :INPUT = [#] [OP []]
OP FPUT :INPUT GETLIST
END

TO PRINTBRIGHT :MESSAGE
BRIGHT 1 PRINT :MESSAGE BRIGHT 0
END

TO HELP
CT
SETCUR [12 0] PRINTBRIGHT "DATABASE
PRINT []
PRINT A.MYNETT APRIL 1985]
PRINT []
PRINT [Facilities available:]
PRINT []
MENU [(SETUP "title) [ADD] [PRINTALL] [RECORD no] [DELETE no] [FIND] [SAVEFILE]
[LOADFILE] [HELP]]
PRINT []
PRINTBRIGHT [TYPE YOUR CHOICE AND PRESS ENTER]
END

TO LOADFILE
PRINT "FILENAME?
MAKE "TITLE FIRST RL
LOAD :TITLE
MAKE "INPUT BF TEXT "FILE
MAKE "FIELDS FIRST :INPUT
MAKE "TITLE FIRST BF :INPUT
ER "FILE ERN "INPUT
END

TO SAVEFILE
DEFINE "FILE ( LIST [1 :FIELDS THING :TITLE ]
SAVE :TITLE [FILE]
ER "FILE
PRINT SE [SAVED AS] :TITLE
END

TO FIND
MAKE "RECORD 0
SEARCHALL SEARCHLIST THING :TITLE
PRINTBRIGHT [END OF SEARCH]
END

TO RECORD :NO
IF :NO > ( COUNT THING :TITLE ) [PRINT ( SE [ONLY] COUNT THING :TITLE [RECORDS 0
N FILE] ) STOP]
PRINTRECORD :FIELDS ITEM :NO THING :TITLE
END

TO PRINTALL
CT PRINTBRIGHT [PRINTING ALL RECORDS]
MAKE "RECORD 0
SEARCHALL [1] THING :TITLE
PRINTBRIGHT [NO MORE RECORDS]
END

TO ADD
CT PRINT []
BRIGHT 1 PR :TITLE BRIGHT 0 PRINT []
PRINT SE [RECORDS HELD] ( COUNT THING :TITLE )
PRINT []
MAKE :TITLE INSERT GETDATA :FIELDS THING :TITLE
PRINT [] SPACE
IF FINISH? [STOP]
ADD
END

TO SETUP :DBASE
MAKE "TITLE :DBASE
TS
( PRINT [SETTING UP DATABASE : ] :TITLE )
PRINT []
PR [ENTER EACH FIELD TITLE:# TO END]
MAKE "FIELDS GETLIST
MAKE "TITLE []
( PRINT "Database :TITLE [set up] )
END

TO MENU :OPTIONS
IF EMPTY? :OPTIONS [STOP]
IF DEFINEDP FIRST FIRST :OPTIONS [PRINT SE CHAR 32 FIRST :OPTIONS]

```

QUALITY DISKETTES

TOP BRAND NAMES GUARANTEED DISKS

PRICE PROMISE:

We will better any genuine delivered price advertised in this issue of P.C.W. on the products below

	3.5"	3M & TDK	
SS DD	10-90		100 +
	3.10		2.70
	5.25	3M BASF & TDK	
	10-90		100 +
SS DD 40T	1.24		1.13
SS DD 80T	1.85		1.69
DS DD 40T	1.69		1.52
DS DD 80T	1.99		2.17
	5.25"	SKC 5 year guarantee	
	10-90		100 +
SS SS 40T	1.04		.94
SS DD 40T	1.10		.99
DS DD 40T	1.28		1.17
SS DD 80T	1.44		1.33
DS DD 80T	1.55		1.44

P&P 50p per box (10-90) £3.50 per 100
All prices excluding VAT

We distribute a full range of accessories, data cartridges, computer tape and rigid disks
Telephone or write for further information to:

CAROUSEL TAPES (MAIL ORDER)
3 PARK PARADE, STONEHOUSE, GLOS,
GL10 2DB
Tel: 045 3822151

DUST COVERS SETS

AMSTRAD CPC 464/664 £6.95

*Matching proofed nylon, treated with anti-static inhibitor. Piping on monitor cover, green for 464, blue for 664. AMSTRAD CPC on keyboard cover.
*Please state model, Colour or Mono.

Tatung Einstein £7.50

One piece cover for monitor and keyboard in proofed light grey nylon. Piped in black with name on keyboard.

Business Machine Covers

Matching proofed nylon with toning piping and name on keyboard: IBM PC £7.50, OLIVETTI M24 £7.50, TEXAS INSTRUMENTS £7.50, ACT SIRIUS £7.50, ACT APRICOT £6.60, APPLE MACINTOSH £6.00. Other covers available on request.

Matching covers for Printers

Amstrad DMP-1, Canon PW 1080A, Commodore MPS 801, Epson FX-80, RX-80, Mannesmann MT-80, Panther DX 109, Shinwa CP-80, CPA-80, Selkoshia 500, Taxan KP810, £3.95; Brother HR5. M-1009, £3.50 and Juki 6100 at £4.50.

ALSO AVAILABLE: Monitor, disk drives and other covers on request.

BBD COMPUTER DUST COVERS

39 MANSE AVENUE, WRITINGTON WN6 9RP

Telephone: 0257 422968

TRADE ENQUIRIES WELCOME

READ & PRINT BAR-CODES USING ANY COMPUTER

Complete identification system including microprocessor controlled scanner hardware plus software to print barcodes on Epson (or similar) dot matrix printer. Most industrial & commercial codes can be read. Packages available for virtually any computer. Our systems are in regular use by many private & public sector organisations worldwide.
Prices start from £250. More information on request.



ALTEK
INSTRUMENTS
Enterprise House
44-46 Terrace Road
Walton-on-Thames, Surrey
KT12 2SD
Tel: (0932) 244110
Telex: 295800 CWAOL

```

63060 DATA189,0,208,56,229,2
63070 DATA157,0,208,144,11,176,21
63080 DATA24,125,0,208,157,0,208
63090 DATA144,12,165,251,208,8,165,252
63100 DATA77,16,208,141,16,208
63110 DATA165,251,208,2,70,252,73,128,133,251
63120 DATA202,16,182,76,49,234
READY.
    
```



Apricot RS232 Status Test

by NHG Deacon

This is a program for the Apricot PC which acts as a fault finder when communicating with other computers over the RS232 serial link. It interrogates the read registers of the Z80 SIO serial interface chip, and displays messages which relate to their functions. If a character is available in the receive

buffer, it is read and displayed after the appropriate message.

Direct addressing of the SIO chip as demonstrated can be used to transmit and receive information at speed from the RS232 port under Basic control. The equivalent command for outputting a character is OUT DTA, char.

```

100 REM ** RS232 status test
110 REM ** SIO channel A port locations
120 DTA=&H60:STATUS=&H62
130 REM ** read registers 0 and 1
140 OUT STATUS,16:RRO=INP(STATUS)
150 OUT STATUS,1:RR1=INP(STATUS)
160 X=RRO AND 1:IF X THEN PRINT " received char. available...";:C=INP(DTA)
:PRINT CHR$(C)
170 X=RRO AND 4:IF X THEN PRINT " transmitt buffer empty "
180 X=RRO AND 8:IF X THEN PRINT " DCD pin active "
190 X=RRO AND 32:IF X THEN PRINT " CTS pin active"
200 X=RR1 AND 16:IF X THEN PRINT " ** parity error **"
210 X=RR1 AND 32:IF X THEN PRINT " ** receiver overrun error **"
220 X=RR1 AND 64:IF X THEN PRINT " ** crc/framing error **"
    
```

PCW is interested in programs written in any of the major programming languages for all home and small business micros. When submitting programs please include a cassette or disk version of your program, brief but comprehensive documentation, and a listing on plain white paper — typed if you have no printer.

Please ensure that the software itself, the documentation and the listing are all marked with your name, address, program title, machine (along with any minimum requirements) and — if possible — a daytime phone number.

All programs should be fully debugged and your own original, unpublished work.

We prefer to receive programs with a maximum 80-column width printed in emphasised typeface.

We will try to return submissions if they are accompanied by a stamped addressed envelope of the appropriate size, but please keep a copy of everything.

Programs are paid for at the rate of £50 per page of published listing, plus a £50 bonus for the Program of the Month. Send your contributions to Owen Linderholm, Program File, PCW, 32-34 Broadwick Street, London W1A 2HG.

FOR ALL YOUR
**DISK COPYING
FORMATTING
VERIFICATION**

AND BULK DISK
NEEDS TRY:

**DISCO TECH
(UK) LTD**
3-6 ALFRED PLACE
LONDON WC1
Tel: 01-631 3600



C LANGUAGE PROGRAMMING?

We offer the complete, professional service for all your C language programming needs. We stock a range of C compilers, utilities, books, function libraries and programming aids, all carefully selected and evaluated to give you the tools you need at an attractive price. Write or ring now for our comprehensive catalogue covering:

- C compilers
- General purpose function libraries
- Database function libraries
- Communications function libraries
- Screen and graphics function libraries
- Programming aids and debugging tools
- Real-time utilities
- Math/science function libraries

C COMPILERS

8088/8806		
• DeSmet		£145
• Lattice		£435
• Computer Innovations		£345
• C Systems		£220
• Mark Williams		£435
• Wizard C		£475
8080/Z80		
• BDS C		£135

This month's special offers

IBM PC C LANGUAGE TUTORIAL

- "Introducing C" Disk Tutor and Interpreter
 - Kernighan and Ritchie "The C Programming Language"
- Introductory Offer — £130

IBM PC C LANGUAGE STARTER PACK

- DeSmet C Compiler
 - Kernighan & Ritchie "The C Programming Language"
 - Essential Software C Utility Library (200+ graphics, DOS, screen functions with source)
- Usual price £320 — Introductory offer £250

Prices exclude £4.00 P&P and VAT

The Core Store Limited
59 Station Rd, Northwich, Cheshire CW9 5LT
Tel: 0606 45420

USED COMPUTER BARGAINS

Rair Business Computer, 20 Megabyte hard disk, 4 Hi Res colour terminals, Hermes high speed line printer. CPM86 and PC DOS, 8 + 16 bit. WordStar professional accounts and spreadsheet. 6 months old, cost-£20,000, now complete£6,000
 Commodore 8032 + 8050, 1 meg drive + software £795
 ACT Sirius 128k, 1.2 meg £995
 ACT wide matrix printer for Sirius £200
 Sharp MZ3500, twin disks, 2"Z80, CP/M, monitor, software £595
 Epson MX80 for above computer £120
 TEC FP1500 d/w printer £225
 Commodore 8000 second processor (Z80) + CP/M software £95
 PBM CPU 5 meg Winchester + floppy + terminal + software £595
 Comart CPU 5 meg Winchester + floppy + terminal, has boards to run extra terminal £595
 Northstar Advantage twin floppy £595
 Commodore 8000 software

Tel: 021-706 9748 Mondays or Thursdays
 (Answerphone on other days)

MICROSAVE SYSTEMS
 SOLIHULL, WEST MIDLANDS

FREE SOFTWARE???

YES!!

Up to 400 disks packed with **FREE** software available when you buy one of our 100% IBM Compatible Olivetti M24 personal computer systems. Free software includes spreadsheets, word-processors, databases, games, etc.

DON'T MISS IT
CALL (0342) 28528 NOW

ARNOLD BLACKWOOD — ADVENTURER EXTRAORDINAIRE

THE TRIAL OF ARNOLD BLACKWOOD
 A very worthwhile addition to the Adventurers' library ...
 CPC464 USER Oct '84

ARNOLD GOES TO SOMEWHERE ELSE!
 "I found it all immensely lively and enjoyable" ...
 T. Kendle PCW Dec '84

THE WISE & FOOL OF ARNOLD BLACKWOOD
 "Buffs will enjoy the paranoia that pervades the adventure"
 PCW Dec '84

BRAWN FREE £2.00
 "The humour was so ridiculous that it is a joy to review" ...
 T. Kendle PCW May '85

***ANGELIQUE: A GRIEF ENCOUNTER**
 The first Romantic Adventure with an emphatically feminine heroine.

Each Adventure **£6.50** inc. By return post
 Cheques/POs to:

NEMESIS
 10 CARLOW ROAD, RINGSTEAD
 KETTERING, NORTHANT NN14 4DW
 Tel: 0933 623967

WANTED PERSONAL COMPUTERS

IBM, TANDY, EPSON, etc
all models bought for cash

MORGAN CAMERA COMPANY

179 Tottenham Court Road,
 London W1.
 Tel: 01-636 1138

DOCUMENT YOUR BASIC PROGRAMS

- ★ VARLIST, a basic programmer's documentation and development utility, available for most CP/M machines.
- ★ Produces a list of variables from your own basic program in sorted order along with line numbers at where they occur.
- ★ Results can be printed out or used as a disk file and be edited by a standard word processor.
- ★ Contains a library of reserved words which can be changed to suit different dialects of basic.

£65 + Basic (includes P&P)
Cash with order, or write for further information to:

Amos Spence Ltd
 92 Burley Road, Leeds LS3 1JP

Quick — before you spend £250 on a WP

PC JOTTER £45

A speedy, handy word processor/editor for the IBM PC and lookalikes — does all you need!

- Fast acting, up to 60K text files in RAM.
- Cursor movement to character, word, line ends, line, page, start and end of file.
- Autowrap and right margin justification if required. Adjustable margins and tabs.
- Keeps backup file, or read only (browse) mode.
- Find and replace functions.
- Block moves, print marked block, or write marked block to a file.
- Read a file into the text.
- Include control characters for direct control of your printer.

(Price excludes VAT. Order value, £45 + £6.75 VAT)

Cheque with order to:

MICROCOSM COMPUTING
 52 Tower Street, Harrogate HG1 1HS
 Tel: (0423) 62055

O'LEVELS

not just revision but also tuition for the Spectrum 48K

MATHEMATICS	8 PROGRAMS
PHYSICS	7 PROGRAMS
BIOLOGY	6 PROGRAMS
COMPUTER ST.	8 PROGRAMS
CHEMISTRY	8 PROGRAMS
FRENCH	8 PROGRAMS
ELECTRONICS	8 PROGRAMS

Each of the programs in a set are divided into between 4 and 14 tutorial sections, making as many as 70 overall. Each section consists of a number of pages of instructive text and diagrams, followed by questions, which where possible are randomly generated.

As used in schools and colleges

Each subject only **£4.95**

BORED WITH BASIC?

Teaching versions of Pascal and C languages, including a screen editor and 48 page tutorial manual. Trace facilities are provided for easy tuition and debugging.

Each language only **£4.95**

GCE TUTORING

40 BRIMMERS HILL, WIDMER END
 HIGH WYCOMBE, BUCKS HP15 6NP

EXPAND YOUR EPSON PRINTER MEMORY

(FX, RX and MX)

BARGAIN PRICES ON UPGRADABLE EPSON BUFFERS (While stocks last)
 PARALLEL/SERIAL

8K.....	£45
16K.....	£49
32K.....	£69
64K.....	£99
128K.....	£129
256K.....	£199

Save time and money by freeing your computer of the burden of a slow printer. All prices include VAT & P&P (please specify printer type when ordering).

P.C.M.L. Ltd

ROYAL MILLS, ESHER, SURREY
 Tel: (0372) 68631/67282
 Access/Visa order welcome



SPECIALISTS IN THE SUPPLY OF BULK CUSTOM WOUND AUDIO/COMPUTER CASSETTES TO TRADE AND EDUCATION

NEW! TURBO LOAD FOR CBM 64 WITH 'ON SCREEN DISPLAY'

DUPLICATION FACILITIES FOR MOST POPULAR HOME COMPUTERS 16 TRACK RECORDING STUDIO

COMPETITIVE RATES. CONTACT US FOR PRICE LIST/QUOTATIONS NOW

JP MAGNETICS LTD

UNIT 4, 7 MARY ST, BRADFORD BD4 8SW
 TEL: (0274) 731651

One stop.

At TABS Business Centres you'll get everything you need to run a small business system.

TABS Business Centres provide a complete range of computer products to help you run your business more efficiently.

Whether you need a simple business computer to run your sales ledger and handle your correspondence or a multi-user system with an integrated accountancy package, you will find everything you need – all in one place.

You will get free expert advice from people who understand the business world, and who have a thorough knowledge of accountancy and microcomputers.

You will also get expert training on how to use your system, a professional installation service and full support for the hardware and the software.



*IBM IBM PC 64, Monitor, Keyboard, Mono Display Printer Adaptor, DOS 2.0 + Tandem Drive.

£21.76 per week + VAT
Over 36 months rental period

IBM XT, Monitor, Keyboard, DOS 2.0, Mono Display Printer Adaptor.

£37.38 per week + VAT
Over 36 months rental period



ACT APRICOT PC, 2 Disk Drives (Double Sided), 720K + 9" High Resolution Monitor – Mono.

£21.30 per week + VAT
Over 36 months rental period

APRICOT Xi 10, 1 Disk Drive + Winchester 10Mb + 9" High Resolution Monitor – Mono.

£31.97 per week + VAT
Over 36 months rental period



OLIVETTI M24 (Typical System), Mono Display, Keyboard + MSDOS, 2 Disk Drives 360/720Kb.

£20.69 per week + VAT
Over 36 months rental period

M24 (Hard Disk System), Mono Display, Keyboard + MSDOS, 1 Disk Drive 360/720Kb, 1 Winchester 10Mb.

£41.62 per week + VAT
Over 36 months rental period

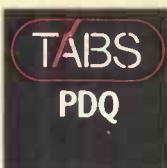

TABS PDQ 1.2, Mono Display, Keyboard + MSDOS, 2 Disk Drives 800K.

£24.44 per week + VAT
Over 36 months rental period

PDQ 10, Mono Display, Keyboard + MSDOS, 1 Disk Drive 800K + 1 Winchester 10Mb.

£41.20 per week + VAT
Over 36 months rental period

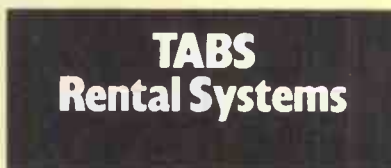

TABS Business Centres offer a Rental Plan which is ideal for companies preferring to keep their capital intact for use within the business rather than tying it up in depreciating assets. The plan allows for the system to be upgraded at regular intervals without high cancellation penalties and includes maintenance and insurance.



For your nearest one stop Business Centre 'phone:

0722-338668

* The IBM PC and XT are only available from TABS Business Centre, Salisbury and those TABS Business Centres who are IBM authorised PC dealers.

FROM £10,000 CREDIT

Simply fill in the coupon and return it to: TABS Ltd, Dolphin House, New Street, Salisbury, Wilts. Please allow 14 days for reply. The TABS RENTAL CARD is valid at all TABS Business Centres.

I WISH TO APPLY FOR RENTAL CREDIT FACILITY.

Name _____
Address _____
Tel No. _____
Company Business Name _____
Nature of Business _____ Position _____
Bankers _____ Branch _____
Account No. _____ Signature _____

Announcing the personal decision-support system that lets you exploit your mainframe data.

With PC/FOCUS, your corporate data is all yours. To personally access and process and act upon.

PC/FOCUS is the most powerful DBMS available for your PC. In fact, virtually a mainframe-level system, developed from the acclaimed FOCUS 4th-generation applications development and information management software.

New Table Talk topples typing

PC/FOCUS integrates a relational database, report writers, a screen manager, graphics, and statistical analysis. Plus the vital new TableTalk window manager lets you make the most of these features, and your own corporate data, all without typing a word.

The micro/mainframe connection

PC/FOCUS works on PC files, as well as extracting and selecting information from mainframe files and databases. With PC/FOCUS you can upload data and personally developed procedures from your PC to your IBM mainframe, all with English commands.

Base your decisions on your data

PC/FOCUS is the tried and tested high-level DBMS that delivers what others only promise.

No longer is your corporate data for DP use only. And no longer is application development a prerogative of programmers. Let Information Builders' PC/FOCUS, your own creativity and your department's computing needs, unlock your corporate data for your personal use.

Complete and send the coupon today, to attend a PC/FOCUS special briefing, or to request more PC/FOCUS facts.

And keep computing personal.

Yes, I'd like to attend a convenient PC/FOCUS management briefing, along with _____ of my colleagues.

PC/4

- Please call me with details.
 Just send information.
 Please arrange a demonstration.

Name:

Position:

Organisation:

Address:

Telephone:

Mainframe type:

PCBG

send to: Sue Gorasia, PC/FOCUS Marketing,
Information Builders (UK) Ltd, Station House,
Harrow Road, Wembley HA9 6DE. 01-903 6111

PC/FOCUS. From Information Builders. For your future

IBM's
PC!

Hard to use,
but

For under £30 this ROM-based package from MIRACLE TECHNOLOGY will give you, your modem and your BBC computer access to Prestel*, Micronet*, Viewdata, telex, electronic mail, bulletin boards and databases, handling baud rates of 1200/1200, 75/1200, 1200/75 and 300/300.

Features include carousel facility, Macro Command File, error trapping and telesoftware downloading.

The package, including full fitting instructions, User Guide and Function Key Guide costs £29.90 inc VAT & UK P/P. Optional keypad for use with DataBeeb's carousel is an extra £11.44 inc if ordered with DataBeeb (£12.59 inc separately).

To get your BBC on-line – clip the coupon today!

Please send me

DataBeeb packages @ £29.90 inc VAT & UK P/P.

Databeeb keypads @ £11.44 inc.

I enclose cheque/postal order

charge my Access/Visa card no:

expiry date . . . / . . . / . . .

Name

Address

Postcode

send to:

BBC Support (4), Miracle Technology (UK) Ltd,
St Peters Street, Ipswich IP1 1XB. Tel 0473-50304.
*reg'd trade marks of the companies concerned

... with the Multi-Viewterm/Datadari modem serial interface plus software package from Miracle Technology.

This unique comms package gives ATARI* users full Prestel* facilities, including graphics, and allows access to Micronet*, Viewdata systems, telex, electronic mail, bulletin boards and databases. Datadari handles baud rates of 1200/75, 75/1200, 1200/1200; 300/300. 850 interface not required.

For models 400, 800, 600XL, 800XL, 65XE, 65XEM and 130XE used with suitable modems.

To get your ATARI on-line, all the way, clip the coupon today.

Please send me

Multi-Viewterm/Datadari packages @ £59.95 inc VAT + £1.15 UK P/P.

I enclose cheque/postal order

charge my Access/Visa card no:

expiry date . . . / . . . / . . .

Name

Address

Postcode

send to:

Atari Support 1, Miracle Technology (UK) Ltd,
St Peters Street, Ipswich IP1 1XB.
Tel 0473-50304.
*reg'd trade marks of the companies concerned

**GET
ON-LINE
WITH
DATABEEB!**

**MIRACLE
TECHNOLOGY**

**FULL
PRESTEL
FOR
ATARI
USERS!**

**MIRACLE
TECHNOLOGY**

Lynnem Acoustic Hoods

As approved and recommended by British Telecom and IBM.

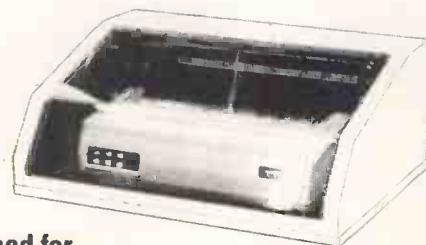

**Designed for
today's office**

Lynnem Computer Products have over 15 years experience in providing the complete solution to the problems of noise caused by today's office equipment.

Built to meet your exact requirement

So before you buy an acoustic hood talk to our experts and compare ours with the Rest!

**Lynnem Computer Products Ltd
277 London Road, Burgess Hill
Sussex RH15 9QU Tel: 04446 3377/6632**

SHARP MZ-7000

S.U.N.

SHARPSOFT USER NOTES are published three times a year and are totally dedicated to the MZ700. They contain program listings, editorial articles, readers letters and plenty of tips and hints on using the MZ700.

SOFTWARE Sharpsoft have the finest range of programs for the MZ700 from machine code arcade action games to programming aids, utilities and business applications.

HARDWARE We specialise in all peripherals and accessories necessary for expanding your MZ700 system: Printers, Disc Drives, Hi-Res Graphics, Interfaces, Cables, Pens, Paper Rolls, Monitors etc . . .

SHARPSOFT 'WITH THE SHARP USER IN MIND'

Please send me:

USER NOTES '84 (UK) £3.00 USER NOTES '84 (OVERSEAS) £6.00

Please join me for:

USER NOTES '85 (UK) £3.50 USER NOTES '85 (EUROPE) £6.00

USER NOTES '85 (OVERSEAS) £7.50

Please send me more information on HARDWARE and SOFTWARE.

I own MZ711, MZ721, MZ731 (Please delete).

I enclose a Cheque/P.O. for £ _____ Access/Visa ___ / ___ / ___

Name: _____

Address: _____

**SHARPSOFT LIMITED, 86-90 Paul Street, London EC2A 4NE
Tel: 01-739 8559**

PCW/8

APPLE'S
MACINTOSH:

Hardly any
software, though

EPSON'S
NEW QX-16
WITH 'TAXI':

there's lots
of software for it.

it's an absolute
doddle to use.

Sorry lads, we've ripped off your best bits.

Making the new Epson QX-16 with 'Taxi' probably the best all-round 16-bit micro, ever.

It's Epson's cracking new software, Taxi, that gives the QX its friendly, Mac-like user interface, which not only features fully customizable/modifiable icons and pop-up menus, but also a mouse.

Taxi also makes industry standard software so easy to use, millions more people out there will want this new,



friendly micro — and of course, Taxi comes only with the QX-16. From Managing Director right down to clerk, anyone can use the QX-16 with Taxi, whatever their line of business.

All that, yet it costs no more than an IBM or an Apple.

It's been a pleasure, writing this ad. All I did was size up the competition and rip off their best bits. And why not? Because through Taxi that's just what Epson's done.

But why take the word of a silver-tongued ad man? — I'm only trying to rip you off, right?

Try me — by doing a little bit of ripping off, yourself. Start with the coupon.

Jim Mulligan

Copywriter

Looks like the QX-16 with Taxi will be a doddle to sell. Please let rip with the details.

Name _____ PCW 8 - QX-16

Company _____

Address _____

Tel. No: _____

Epson (U.K.) Ltd., Dorland House, 388 High Road, Wembley, Middlesex HA9 6UH, U.K. Telephone: 01-902 8892.

EPSON

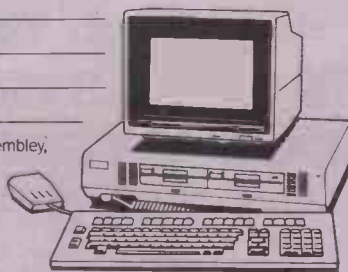

Ace down the line.

Punch data down the line with Miracle Technology's Modem WS2000.

WS2000 links your computer into the world-wide telephone network — the world of PRESTEL, Telecom Gold, Telex, MICRONET, databases and bulletin boards.

Flexible, versatile, high quality WS2000 wins every point, as over 11,000 business and home users know. MICRONET recommended, PCN Best Buy, British

Microcomputing Awards Finalist — WS2000 plays its rival off the court!

Our match winner, with BT telephone lead, mains power supply and comprehensive manual, costs £129.95 ex. (£154.73 inc. VAT & UK delivery). We can also supply the necessary leads and software for most computers — an unbeatable service!



Plus Free
Quarter's
Micronet Subscription

Prestel is a Registered Trade Mark of British Telecommunications PLC. Micronet 800 is the Trading Style of Telemap Ltd and British Telecommunications PLC

MIRACLE TECHNOLOGY

MIRACLE TECHNOLOGY (UK) LTD ST PETERS STREET IPSWICH IP1 1XB ENGLAND
 ☎ (0473) 50304 5 LINES TELECOM GOLD:79: KEY 001 📠 946240 CWEASY G 19002985

URGENTLY REQUIRED



As a Games Software Developer, working under contract to several of the best known software houses, we have an urgent requirement for high quality machine code ATARI programmer to work on conversion from CBM 64 and SPECTRUM titles.

*Good steady work and rates of pay apply.

Please send in C/V, together with any Software samples of recent works to:-

R. A. BUFFREY
15 HIGH STREET, LYDNEY
GLOUCESTERSHIRE GL15 5DP
Tel: 0594 43352

DRIVE A TAXI FREE

(INC. TIPS)

IBS HAVE IN STOCK A NUMBER OF EPSON QX-16s FOR YOU
TO TEST DRIVE— ABSOLUTELY FREE.

ALSO IN STOCK
WE HAVE THE WHOLE RANGE OF EPSON PRINTERS AND COMPUTERS
FOR IMMEDIATE DELIVERY. PAYMENT IS POSSIBLE BY ALL THE
MAJOR CREDIT CARDS.

CONTACT US FOR FREE TAXI RIDES AND GREAT DEALS ON PRINTERS.

WE'LL GET YOU TO WHERE YOU WANT TO BE.



IBS

Immediate Business Systems plc
3 Clarendon Drive, Wymbush, Milton Keynes
Buckinghamshire. MK8 8DA England

COMLEX

COMPUTERS — PRINTERS — MONITORS — DRIVES — SOFTWARE

COMPUTERS

Apricot F1e 256K	£535.00
Apricot F1 256K	£775.00
Apricot Point 7	£2,700.00
Apricot Portable 256K 1x720K Drive	£845.00
Apricot 256K 2x720K drives and monitor	£1,525.00
Apricot Xi 256K 10MB and monitor	£2,175.00
Apricot Xi 512K 10MB and monitor	£2,595.00
Apricot Xi 512K 20MB and monitor	£2,995.00
Advance 86B	£750.00
Ferranti 860	P. O. A
Ferranti 860 10MB	P. O. A
Sanyo 555	£798.00
P. C. Hard disc upgrade 10MB	£899.00
P. C. Hard disc upgrade 20MB	£1,130.00
A. T. Hard disc upgrade 10MB	£645.00
A. T. Hard disc upgrade 20MB	£820.00

PRINTERS

Mannesman Tally	£173.00
Epson LX80	£216.50
Epson RX100	£329.00
Epson FX80	£325.00
Epson FX100	£404.00
Epson JX80	£416.00
Epson DX100 daisywheel	£349.00
Epson LX1500	£799.00
Epson H180	£329.00
Canon 1080A	£243.00
Canon 1156A	£329.00
Juki 6100	£321.00
Juki 6300	£799.00
Sheet feeder for the above	£179.00
Silver Reed 400	£275.00
Silver Reed 500	£325.00
Silver Reed 550	£499.00
Silver Reed 770	£725.00
Sheet feeder for 550/770	£199.00

Further range of printers available —
phone for details.

MONITORS

Philips 7502 (Green)	£69.00
Philips (Amber)	£74.00
Philips 7513 IBM	£83.00
Microvitec 1431	£173.00
Microvitec 1451	£234.00
Microvitec 1441	£365.00
Microvitec IBM	P. O. A

BUSINESS SOFTWARE

Lotus 1-2-3	£295.00
Wordstar 2000	£295.00
Framework 1-1	£319.00
Supercalc 3	£289.00
Supercalc 2	£189.00
dBase III	£319.00
dBase II	£235.00
Pegasus Accounts	P. O. A
Map Accounts	P. O. A
Wordstar Professional	£259.00
Multimate 3.3	£259.00
Multiplan	£185.00
Chit Chat	£109.00

Other software packages available —
phone for details.

BBC DISC DRIVES

Opus 5401	£86.00
Opus 5802	£121.00
Opus 5802D	£274.00
Cumana CFX100	£86.00
Cumana CFX400	£121.00
Cumana CD800S	£274.00

GOVERNMENT AND EDUCATIONAL ORDERS WELCOME, EXPORT ENQUIRIES WELCOME.

ADD £8.00 FOR NEXT DAY DELIVERY — ADD 15% VAT TO ORDER TOTAL

COMLEX

UNIT 7, FIFE STREET, NUNEATON, WARWICKSHIRE CV11 5PR

Tel: (0203) 371371



APRICOT COMPUTERS

F1e 256K 1x315K Disk Drive	EX VAT £499
F1 256K 1x720K Disk Drive	£699
FP1 256K 1x720K Disk Drive	£845
FP2 512K 1x720K Disk Drive	£1149
PC 256K 2x315K Disk Drives	£1199
PC 256K 2x720K Disk Drives	£1349
Xi10 256K 10Mb Winchester	£2049
Xi10s 512K 10Mb Winchester	£2645
Xi20 512K 20Mb Winchester	£2849
Xi20s 1Mb 20Mb Winchester	£3415

APRICOT MONITORS (F1, PC or Xi range)

9" Mono £170 12" Mono £212 10" Colour £349

OLIVETTI COMPUTERS

M24 256K 2x360K Disk Drives	£1675
M24 256K 2x760K Disk Drives	£1910
M24 256K 10Mb Winchester	£2800
M21 256K 2x360K Disk Drives	£1580
M21 256K 2x760K Disk Drives	£1805

PRINTERS

BROTHER HR 5	EX VAT £140
BROTHER HR 15 18cps	£330
BROTHER HR 25 25cps	£635
BROTHER HR 35 35cps	£745
CANON PW 1080A 160cps (NLQ)	£285
CANON PW 1156A 160cps (NLQ)	£385
DIABLO 630 ECS API	£1865
DIABLO 630 ECS IBM-PC	£1725
EPSON RX 80 F/T + 100cps	£225
EPSON LX 80 100cps (NLQ)	£215
EPSON FX 100 160cps	£445
EPSON LQ 1500 200cps (NLQ)	£895
JUKI 6100 20cps	£349
JUKI 6300 40cps	£779
NEC PINWRITER P2 180cps	£395
QUME LETTERPRO 12/20 20cps	£495
QUME SPRINT 11/40 40cps	£1215
QUME SPRINT 11/55 55cps	£1440
QUME SPRINT 11/90 90cps	£1925
RICOH 1600S 32K 60cps	£1495
RITEMAN II 160cps (NLQ)	£299

SOFTWARE

CASHLINK	£445
CAXTON CARDBOX	£165
dBASE II	£265
dBASE III	£325
DMS DELTA 4	£375
DMS DELTA +	£155
FRAMEWORK	£345
FRIDAY	£135
KNOWLEDGEMAN	£380
LOTUS 123	£345
MICROSOFT WORD	
MULTIMATE	£295
MULTIPLAN	£130
OPEN ACCESS	£340
SAGE ACCOUNTS	£250
SAGE EXECUTIVE	£495
SAGE CHIT CHAT	£115
SUPERCALC 3	£215
SYMPHONY	£425
WORDSTAR	£195
WORDSTAR PROFESSIONAL	£260

3M is a trademark

Order all your Computer requirements from Pathfinder Computer Systems and you may be sure of prompt delivery, superlative value and efficient, trouble-free operation.

3M DISKETTES

Price/box of ten	1-4	5-9
3.5" SS	£34.00	£31.00
3.5" DS	£44.50	£41.00
5.25" SS/DD 48tpi	£15.00	£14.00
5.25" DS/DD 48tpi	£19.10	£18.00
5.25" SS/DD 96tpi	£23.00	£20.70
5.25" DS/DD 96tpi	£24.80	£22.80
5.25" IBM PC AT	£44.00	£39.50

Authorised Distributor
Data Recording Products



Please contact us for our Competitive
Quotation for all of you Computer Supplies
(ie: Disk Boxes, Ribbons, Paper, Calm
Covers, Files, etc).

Pathfinder Computer Systems
55 Bridge Street/Motor Street
Manchester M3 3BQ
England
Telephone 061-832 8272/7707

We accept Official Orders
from UK Government and
Educational Establishments.



Silicon Chip

No. 1 FOR ATARI*

Atari 520 ST

GUARANTEE

Our EXCLUSIVE Direct Exchange Guarantee is available FREE OF CHARGE to all our customers. If a product purchased from SILICON CHIP becomes faulty due to a manufacturing or component defect, within ONE YEAR of purchase, we will, subject to availability, exchange for new.



PRICES

Atari 520 ST
+ 1500k Disk Drive
+ Black & White
Monitor **£749.99**

The prices of the ST from SILICON CHIP Ltd, include Basic, logo, GEM write, BOSS operating systems and GEM paint.

POWER WITHOUT THE PRICE

Chipsoft Integrated Accounts Package:-
Including Stock Control, Norminal, Sales and Purchase Ledgers **£250**
ST/Centronics Printer lead **£29.99**
ST/Midi lead **£14.99**
Final prices and specs may be subject to change.

SPECS

512K RAM.
Expandable Rom.
MIDI Interface. RS232
Serial/Centronics Parallel
Interfaces. Floppy Disk and Hard
Disks Interfaces. RGB Video and TV
outputs. Sound Generator with 3 channels.
2 Joystick Ports. 3 Graphics and Text Modes -
320x200 = 512 colours, 640x200 = 4 colours, 640x400 B/W.
16 Bit Motorola 68000 Microprocessor running at 8 MHz.

**SILICON CHIP LTD, Showroom address:
302 High Street, Slough, Berkshire. Tel: 0753 70639**

- * 1st Atari Business Centre.
- * 1st Dealer for 130 XE.
- * 1st Dealer for 1029 Printers.
- * 1st Dealer with our own Software House for Software Support.
- * 1st Dealer for 520 ST

Please phone or write for full details. Dealer enquiries welcome.



KIRKLANDS BUSINESS SYSTEMS LTD PRINTER

SUPER DEAL

Simply the lowest price
printer suppliers
anywhere in the UK

EPSON Price Breakthrough

LX80	£240.00	FX80	£355.00	DX100 (Daisy)	£410.00
LX80 Tractor Feed	£20.00	FX100	£465.00	LQ1500	£920.00
RX100	£375.00	JX80	£483.00	HI80 Plotter	£380.00

STOP PRESS: The new Epson LX80 with Tractor Drive available from us now. (Letter quality print). Just £250.00

Beautiful BROTHER Printers

HR5	£148.35	HR35	£793.50	New 2024	£900.00
HR15	£378.35	New M1009	£178.25		
HR25	£631.35	EP44	£212.75		

LOOK: Now Available. Double sided double density discs (usually XIDEX or FUJI BRAND) with our own labels. **ONLY £14.00/Box 10. P&P 50p per box.**

We also stock all printer peripherals — call us for the best prices in the UK

All prices include VAT. P&P Next day: £12.00 or £8.00 for normal service. Educational orders welcome

All products carry a FULL 1 YEAR WARRANTY. Shop hours: 9.00-5.30 Mon-Fri

KIRKLANDS BUSINESS SYSTEMS LTD
KIRKLAND HOUSE, 27 CITY ROAD, STOKE
Tel: 0782 414333

SEE US AT
STAND 3003 AT
THE PCW SHOW

PC USERS

DO YOU COMMUNICATE?

Turn your PC into a window on the world and communicate with the new world of electronic mail, databases and networks.

Send telexes around the world, gather information from a database and link to electronic mail networks such as BT Gold, Easylink, One to One, Prestel etc.

Modem House supply all equipment to turn your PC or compatible into a communicating machine. Software and Hardware is perfectly matched to ensure that all **YOUR** requirements are met, present and future.

COMPLETE SYSTEMS FROM £150 TO £2500.

1985 IS THE YEAR OF COMMUNICATIONS
SO COMMUNICATE WITH MODEM HOUSE NOW!

MODEM HOUSE

IOLANTHE DRIVE EXETER DEVON EX4 9EA Tel: (0392) 69295

THE BYTESHOP SOUTHAMPTON

SOUTH COAST'S
LEADING NETWORK
SPECIALISTS

COME AND SEE THE
IBM NETWORK
IN OPERATION

*RING RUSS WILMOT
FOR A DEMONSTRATION*

**Tel: SOUTHAMPTON
(0703) 334711**

FATTEN UP YOUR MAC

AS DESCRIBED IN JULY '85
PCW, LET DIGITAL CIRCUITS
TAKE THE RISK OUT OF
UPGRADING YOUR MACINTOSH.

WE WILL UPGRADE YOUR
MACINTOSH FROM 128K TO
512K FOR ONLY
£200.00 (P&P EXTRA)

Telephone:
DIGITAL CIRCUITS LTD
ON 01-979 2680
ASK FOR MR W. WEEKS

LEIGH COMPUTER SYSTEMS

NORTH STAR DIMENSION
THE IBM COMPATIBLE

Multi-User System (up to 12 users), 15Mb hard disk and 2-user
stations complete with VDU running IBM graphics.....£6,300
Each subsequent work station (8088 CPU 128k RAM)£1,450

apricot FULL RANGE — PRICES ON APPLICATION

COMPUTERS

Advanced 86B.....	£750
Ferranti 860.....	£1,249
Ferranti 860 10Mb.....	£2,150
Sanyo 555 + monitor.....	£795
Commodore PC.....	£1,499

HARD DISKS

EXTERNAL:	
10Mb.....	£1,285
20Mb.....	£1,495
INTERNAL:	
PC 10Mb.....	£955
PC 20Mb.....	£1,250
AT 10Mb.....	£695
AT 20Mb.....	£895

MONITORS

Philips 7502 (green).....	£74
Philips 7522 (amber).....	£78
Philips 7513 (IBM).....	£89
Microvitec 1431.....	£189
Microvitec 1451.....	£235
Microvitec 1441.....	£389
Microvitec IBM monitors.....	prices on application.

PRINTERS

Mannesmann Tally MT80.....	£175
Epson LX80.....	£218
Epson RX100.....	£339
Epson FX80.....	£324
Epson FX100.....	£415
Epson JX80.....	£425
Epson DX100 Daisywheel.....	£355
Epson LQ1500.....	£825
Epson H180.....	£355
Canon 1080A.....	£251
Canon 1156A.....	£339
Juki 6000.....	£325
Juki 6300.....	£825
Sheet feeder for above.....	£185
Silver Reed 400.....	£275
Silver Reed 500.....	£325
Silver Reed 550.....	£499
Silver Reed 770.....	£725
Sheet feeder for 550/770.....	£199

DISK DRIVES

CUMANA/OPUS	
CFX100/5401.....	£89
GSX400/5802.....	£129
GD800S/5802D.....	£279
Other drives available.....	phone for details

All price exclusive of VAT and £8 carriage.

Seminars available on range of standard software —
phone for details. Many other products supplied, including
many standard business software packages at competitive
prices. Competitive prices matched on cash and carry.

**75 CROSS STREET
SALE
GREATER MANCHESTER
Tel: 061-905 2144**

**7 COVENTRY ROAD
HINCKLEY
LEICESTERSHIRE
Tel: 0455 612139**

manage **FIXED ASSETS** with

ASSET MANAGER

and control your capital investment

- ★ *apricot (F1 to Xi) and Sirius/Victor*
- ★ *stand-alone or integrated with Pegasus, Pulsar or TABS*
- ★ *5 depreciation methods available, also caters for no depreciation (eg land)*
- ★ *depreciates to any residual value; caters for grant aid received*
- ★ *detail schedule of fixed assets; assets can be grouped (eg motor cars) for a summary schedule*
- ★ *full audit trail*

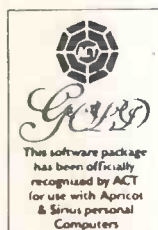

BIMACS Limited

48 Wood Street
Lytham St Annes
FY8 1QG

Tel: 0253 723221

ADVERTISERS INDEX

A		Disking	15	L		Q	
ACT	120, 121	Display Telecommunication Corp	179	Lamnia	122	Quine	119
Actel	70	Downing Electronics	41	Lantech	93		
Advanced Resources	70			Laskys	84, 85		
Aegis	139	E		Leabus	35	R	
Alphadisc	66	Epson	80, 81, 223, 225, 227, 229, 231, 267, 269, 270, 271	Leigh Computer Systems	276	Regional Systems	107
Amstrad	88, 89			Living Software	129	Robocom	90
ATT	4			London Computer Centre	94		
Autoram	78						
		F		M		S	
B		Ferranti	211	Macob	75	Sage	82, 83
Barbatan	147	First Software	97	Mannesman Tally	103	Sanyo Micro Users Association	76
Bimacs	276			Mancos	75	Shekhana	112
Bits Per Second	98	G		Map '80 Systems	91	Silica Shop	47
Boot Out	98	Garwood	112	Matmos	10	Silicon Chip	263
Brighton Computer Centre	113	Grafax	151	Mayfair Micros	14, 197	Silicon Valley	IPC, 7
Business Land	104	Grey Matter	279	Memorex	108, 109	Simon and Schuster/Softsel	32, 33
The Byteshops	72			Metacomco	65	Stirling	75
The Byteshop (Southampton)	276	H		Microcomputer Services	165	Supermicro	139
		Halsey and Co	141	Microgeneral	12	Swanley	70
C		Hayden Software/Softsel	38, 39	Microperipherals	IBC	System Science	93
Cambridge Computer Store	78	Hi-Soft	93, 98	Microprocessor Engineering	41		
Cambridge Microelectronics	77	Hi-Tech	197	Microproducts International	132	T	
Carrera	35	Honeywell	5	Microrent	68	Tab's	43
CDS	125	I		Mighty Micros	159	Tandy	95
Cerac	94	IDS	112	Mill Hill Computers	141	Tashia	11, 13
Chromasonic	113	Insurance Solutions Consultants	35	Mini Micros	94	Technomatic	114
C-Itch	74	Interlex	41	Mirage Micros	76	Thoughts and Crosses	9
Clive Computer Systems	215	Immediate Business Systems	273	Modem House	275	Timatic	141
Compuplant	9	ITS	16	Modular Technology	76	Trisoft	159
Computatech	197			Morgan Camera	106	Twillstar	107
Computer Enterprises International	37	J		Morse Computers	117		
Concordia	4	Juki	193	N		U	
Crestmatt	155	K		Network	70	U-Micros	87
Cumana	69	KDS	4	Northwest Computer Supplies	105		
		Keelecodes	10			V	
D		Kempston	77	O		Vignesh	79
Data Distributors	96	Kendall	157	Opus	14	Vision Stor	91
Data Star	45	Kestrel	159	P		Viza Software	173
Da-Vinci	67	Kirklands	275	Pam Computers	16		
Digital Circuits	276			Pathfinders	274	W	
Digital Research	201	L		P.C. Communications	127	Westwood	41
Digitask	75, 126	Leicester Computer Supplies	250	Personal Computers	OBC	Wolferown	92
Digiturst	122	Logical Micro Systems	244	Pinner Word Pro	105	Worldwide	86
Digitus	1	Logifix	238	Programme Technology	189		
Disco-Technology	73	Logitech	243				
Discount Micros	71	M					
		JP Magnetics	256				
		Micro City	252				
		Micrologic Consultants	239				
		Micromods	248, 250				
		Micropower	251				
		Microsave Systems	256				
		Mid Surrey Media	240				
		MLI Technology	255				
		Morgan Camera	256				
		N					
		Nemesis	256				
		Newcrown Computers	232				
		Northside Computers	254				
		O					
		One Stop Micro Service	254				

MICROMART ADVERTISERS INDEX

A		E		L		P	
Ack Data	248	Eden Trade Computers	241	Leicester Computer Supplies	250	Paul Fray	251
A-Line	233			Logical Micro Systems	244	PCML Ltd	256
Altek Electronics	253	F		Logifix	238	Peterson Electronics	234
AMA	243	Figure Flow	242	Logitech	243	Premier Systems	244
Amos Spence	256	Frimpton Computer Centre	246, 247	M		Professional Magnetics	246
Anita Electronics	236			JP Magnetics	256	R	
Ashley Computers	249, 251	G		Micro City	252	Ringdale Engineering	244
		GCE Tutoring	256	Micrologic Consultants	239		
B		Go To Computing	245	Micromods	248, 250	S	
BBD Dust Covers	253	H		Micropower	251	Software Technology	247
Binary Banana	242	Hemel Computer Centre	250	Microsave Systems	256	Sumlock Electronics	238
Budget Typesetting	234	Hilltec Electronics	232	Mid Surrey Media	240	Supersoft	235, 247
		Hollbarn Ltd	252	MLI Technology	255	Synchronicity	246
C		K		Morgan Camera	256		
Cairn Associates	233	Kambal Data Systems	237	N		T	
Carousel Tapes	253	KECM	238	Nemesis	256	Trisoft	235, 237, 239, 241
Cenprime	246	KGJ Insurance	252	Newcrown Computers	232	TV Services of Cambridge	248
Commercial Products	232	Kingsley Enterprises	234	Northside Computers	254		
		KK Stationers	239	O		W	
D				One Stop Micro Service	254	WD Software	245
Datatech	242					Wordsmiths	236
D+R Electronics	236						
Disco Technology	255						

PASCAL COMPILERS

The new version 3.0 of TURBO Pascal is here. Some Microsoft & DR products are at bargain prices. We also have a selection of Pascal Libraries and Toolboxes not shown here.

8-bit	Nevada Pascal (JRT4)	£ 40
	Turbo Pascal v3.0	£ 55
	DR Pascal/MT+	£ 99
	Pro Pascal	£199
16-bit	Utah Pascal (JRT)	£ 40
	Turbo Pascal v3.0	£ 55
	Microsoft Pascal	£ 95
	SBB Personal	£160
	SBB Professional	£395
	Practical Pascal	£145
	Pro Pascal	£290
	DR Pascal/MT+86	£295

For information or advice call us.

MODULA-2 & ADA

New products this month are the Zurich native code compiler for Z80, the Interface Technologies Compiler, a delightful product for the IBM PC, and the 'affordable' JANUS C-Pack.

MODULA-2 COMPILERS

Modula Corp (MS-DOS,Apple)	£ 95
Zurich Compiler (Z80 CPM)	£160
Volition (various)	from £265
Logitech (MS-DOS,CP/M-86)	£380
Interface Technologies(PC-DOS)	£225

ADA (subset) COMPILERS

Augusta (CP/M-80)	£ 80
Supersoft (CP/M-80)	£180
Janus D-Pack(CP/M-86,MS-DOS)	£895
Janus C-Pack(CP/M-86,MS-DOS)	£150
Janus (CP/M-80)	£125

For information or advice call us.

THE BASIC LANGUAGE

In addition to an exceptional range of structured basics we have bargains among the Microsoft BASIC's.

8-bit	CBASIC	£125
	CBASIC Compiler	£385
	MBASIC Interpreter	£ 80
	MBASIC Compiler (BASCOM)	£375
	BBC BASIC Interpreter	£ 95
	S-BASIC Compiler	£185
	ALCOR multi-BASIC	£135

16-bit	GW-BASIC 1.0 Interpreter	£ 80
	GW-BASIC 2.0 Interpreter	£ 95
	GW-BASIC Compiler	£125
	MS-BASIC Interpreter	£330
	MS-BASIC Compiler	£135
	MS Bus.Basic Compiler	£440
	CBASIC	£250
	CBASIC Compiler	£450
	Applications BASIC	£395
	Better BASIC	£195
	MEGABASIC	£375
	Professional BASIC	£ 99
	ALCOR Multi-BASIC	£135

For advice or information call us.

HIGH-LEVEL LANGUAGES

The products listed here are a very diverse grouping. If you suspect that you need more than a conventional 'procedural' language to solve your problem then we can advise which of these languages might suit you.

PROLOG

8-bit	micro-PROLOG	£ 75
	PROLOG-1	£225

16-bit	PROLOG-86	£135
	micro-PROLOG v3.1	£150
	micro-PROLOG v4.0	£265
	PROLOG-1	£299

LISP

8-bit	Toolworks LISP/80	£ 45
	iLisp	£ 80
	Waltz Lisp	£170
	muLisp-80	£190

16-bit	Toolworks LISP/86	£ 45
	BYSO LISP	£ 95
	IQ Lisp	£195
	muLisp-86	£240
	Gold Common Lisp	£550

NIAL, SNOBOL, muMATH

muMath/muSimp	from £240
Q'Nial (IBM PC)	£350
SNOBOL4+	£ 85

EXPERT SYSTEM SHELLS

Micro Expert	£500
APES	£180
ES/P ADVISOR	£595

SMALLTALK

Methods (PC-DOS)	£265
------------------	------

For advice or information call us.

FORTRAN COMPILERS

We are introducing here the Lahey and RM professional quality Fortran 77 compilers. Our Microsoft 16-bit compiler is a bargain. We also stock several Fortran Libraries

8-bit	Nevada Fortran	£ 35
	Pro-Fortran	£199
	Microsoft Fortran	£475

16-bit	Microsoft Fortran	£ 95
	DR Fortran 77	£270
	Pro-Fortran	£290
	Lahey Fortran F77L	£495
	RM/FORTRAN 77	£495

For advice or information call us.

PRICES & DELIVERY

Prices do not include VAT or other local taxes but do include delivery in UK & Europe. Please check prices at time of order, ads are prepared some weeks before publication.

Many other products are stocked for which there is no space here.

We welcome payment by credit cards including telephone orders.

THE C LANGUAGE

New versions from Aztec, Wizard, Toolworks and Microsoft, the new C-TERP, several new libraries, and lower prices for Lattice & Aztec.

C COMPILERS

8-bit	Aztec C II v1.06D	£160
	Aztec C65 v1.05C	£160
	BDS C v1.50a	£110
	Toolworks C/80 v3.1	£ 45
	Eco-C v3.1	£190

16-bit	Aztec C86/BAS v1.06D	£160
	Aztec C86/PRO v3.2	£350
	CI Optimizing C86 v2.2	£295
	C-Systems C v2.0	£210
	De Smet C88 v2.4	£145
	Digital Research C v1.1	£270
	Lattice C v2.14	£350
	Mark Williams MWC86 2.0	£425
	Microsoft C v3.0	CALL
	Toolworks C/86 v3.1	£ 45
	Wizard C v2.1	£395

C INTERPRETERS

Instant-C v1.01	£395
RUN/C v1.1	£130
C-terp	£295
Introducing C	£125

C LIBRARIES

Data base	C-tree (source)	£325
	Multikey	£170
	db-VISTA (source)	£395
	V-FILE	£295
	Btrieve	£245
	C-to-dBase (source)	£150
	Phact	£250
	SoftFocus Btree(source)	£ 90
	dbc (dBASE III)	£195

Graphics	Multi-HALO	£195
	C Tools (source)	£110

Screen	Panel	£245
	Lattice Windows	£235
	Windows for C	£195
	Curses	£110

Misc	Greenleaf Functions, see	£175
	C Food Smorgasbord	£150
	Plink-86	£325
	Pfix Plus	£325
	C Helper, source	£135
	C Refiner	£145
	Basic C	£175
	Bastoc	£325

More libraries not listed here.

DISK COPYING SERVICE

Moving data and program files from one machine to another is often made difficult because different manufacturers have adopted different disk format standards.

We can copy your files to and from over 400 disk formats including CP/M, CP/M-86, MS-DOS, PC-DOS, ISIS, APPLE, SIRIUS, TORCH, APRICOT, HP150, TRSDOS, DEC RT-11, and IBM BEP.

Disks are normally despatched on the day they are received.

Our charge is £10.00 + disk + VAT. Special prices for quantities.

For more information call us.

GREY MATTER

4 Prigg Meadow, Ashburton, Devon TQ13 7DF.
TEL. (0364) 53499

GREY MATTER

4 Prigg Meadow, Ashburton, Devon TQ13 7DF.
TEL. (0364) 53499

GREY MATTER

4 Prigg Meadow, Ashburton, Devon TQ13 7DF.
TEL. (0364) 53499

THE Maxwell

Monday, July 15, 1985 FORWARD WITH BRITAIN



THE LOVELY LINDA

THE lovely Linda's not just a beautiful body, she's got brains as well — just put her down by a micro and watch her move. In fact, she gets so excited by the machine that she's had to develop her own style of air-conditioned clothing. Note the high rise of the bottom part of this outfit, especially designed to maintain muscle control through all those happy hours of keyboard-bashing. And check out the swept-back hair which prevents her view of the screen being obscured — just another example of brains meeting beauty. *(Are you sure this is a Sinclair machine, I thought they were small and black? Or perhaps that's one in the bottom right-hand corner? Better check before publishing.)*

SID GOES BONKERS

SID BONKERS is an angry man today following his failure to become manager of Oxford United, one of the most coveted jobs in football. The former Neasden supporter, who was not even given an interview by Oxford United

chairman Robert Maxwell, is as sick as a parrot.

Tired and emotional, he explained: "I can't believe it. I've flicked my way through some of the toughest matches ever played on a Subbuteo pitch and taken a

MAXWELL SAVES SINCLAIR

£12m bid rescues computer firm

WORLD EXCLUSIVE

MIRROR Publisher Robert Maxwell last month mounted a dramatic £12 million rescue bid for Sir Clive Sinclair's home computer company. Mr Maxwell said: "I was glad to have been able to help in the survival of Sinclair Research, one of Britain's great national assets. I look forward to working with Sir Clive — a man of brilliant inventive genius."

Mr Maxwell and Sir Clive talked for nine hours with their advisers at the headquarters of Mr Maxwell's company, Pergamon in Oxford, before making the announcement.

Sir Clive said: "I am quite delighted to be associated with Mr Maxwell, whom I have long admired and who has been a friend for many years. I am very pleased that Sinclair Research will be in such good hands with its future assured."

A statement from Downing Street added: "The Government has been aware that these



SIR CLIVE: "Which way's Oxford?"

talks have been going on, and it welcomes any move to put the Sinclair business on a firm footing."

team through the many leagues of Kevin Toms' Football Manager, so you can understand how I feel to have been rejected for this job.

"I only ever played Football

Manager on the Spectrum. Not even International Soccer on the Commodore, with its graphics and sound, could seduce me away from this English micro of micros."

FULL-TIME SCORES

Oxford Utd Reserves.....3	Real Madrid.....1
Working Qls.....5	Retired Qls.....1
May winner.....ChipChat	Simon Bennett.....Derby

BINGO. BINGO. BINGO. NEWS. BINGO. BINGO. BINGO.

Affordable and reliable printers from **Micro P** give you more **Quality** **CPS** for your money

MP Micro P
CPA 80 - 100 cps
+ EPSON COMPATIBLE
CPB 80 - 130 cps
+ IBM COMPATIBLE
FROM **£199***



MP Micro P
MP 165 - 165 cps
+ EPSON COMPATIBLE
NLQ PRINTER
FOR ABOUT **£269***



MP Micro P
CPP 40 - 4 COLOUR
PORTABLE
PRINTER/PLOTTER
FOR ABOUT **£79***

Even in today's high tech world, for most of us, the written word is still the least expensive means of sending and receiving information. If you own a microcomputer the chances are that sooner or later you are probably going to need a printer in order to get into print.

Micro P - CPP40

A low cost 4 colour 40/80 column printer/plotter capable of printing text or graphics on plain paper. The CPP40 is an ideal companion for small and portable micro's, as it is fitted with re-chargeable batteries - perfect for beginners.

Micro P - CPA80

With 100 cps quality printing, the CPA80 probably gives more cps/£ than any other printer available today. The CPA80 is packed with features you would normally find on a more expensive printer. With an optional RS232 version available (even for the QL) this Epson compatible printer will hook up to almost any micro.

Buy from your local dealer today!

Micro P - MP165

Looking for a matrix printer as well as a daisywheel? Well, the MP165 combines all the attributes of these two technologies to give a matrix printer capable of printing at up to 165 cps, as well as providing crisp Near Letter Quality, (NLQ) print at 75 cps. Features include a 2k buffer as well as both friction and tractor feed, as standard. Ideally suited to most popular micro's, the MP165 is now available in a new RS232 QL compatible version.



Micro Peripherals Ltd

"PRINTERS FOR ALL APPLICATIONS"
INTEC UNIT 3, HASSOCKS WOOD, WADE ROAD,
BASINGSTOKE, HANTS. ENGLAND, RG24 0NE.
Telephone: BASINGSTOKE (0256) 473232 (32 lines).
Telex: 859669 MICROP G Facsimile: 0256 461570

* Full 12 months warranty - RRP ex. VAT. QL is a registered Trade Mark of Sinclair Research.

Macintosh™ and all that Jazz!

At our Macintosh Centre, you'll be surprised how quickly you can play solo on Apple's Macintosh — even if it's the first computer you've ever laid hands on.

Now you can try JAZZ too — the brilliant new business software from Lotus that's designed **specifically** for the Macintosh, and makes full use of all its easy-to-use features. JAZZ lines up five business essentials: word processing, graphics, spreadsheet, database and communications — yet even a complete novice can be playing a wide repertoire in just a couple of hours.

In the heart of the City, The Macintosh Centre has a full range of business computers and software,

plus our professionals on hand for advice. Whether your business is trad or modern, you'll applaud the total support services you get from the Personal Computers Macintosh Centre . . . consultancy . . . expert training . . . qualified engineering . . . plus an in-depth understanding of the business software you need.

As one of the largest and longest established microcomputer dealers in the UK, we have a history of successful performances with the City's leading firms.

Try a few of your favourite numbers with JAZZ at our Macintosh Centre: with backing from Personal Computers, you won't have to sing the blues.

Personal Computers Ltd.

218 & 220/226 Bishopsgate, London EC2M 4JS
Telephone 01-377 1200

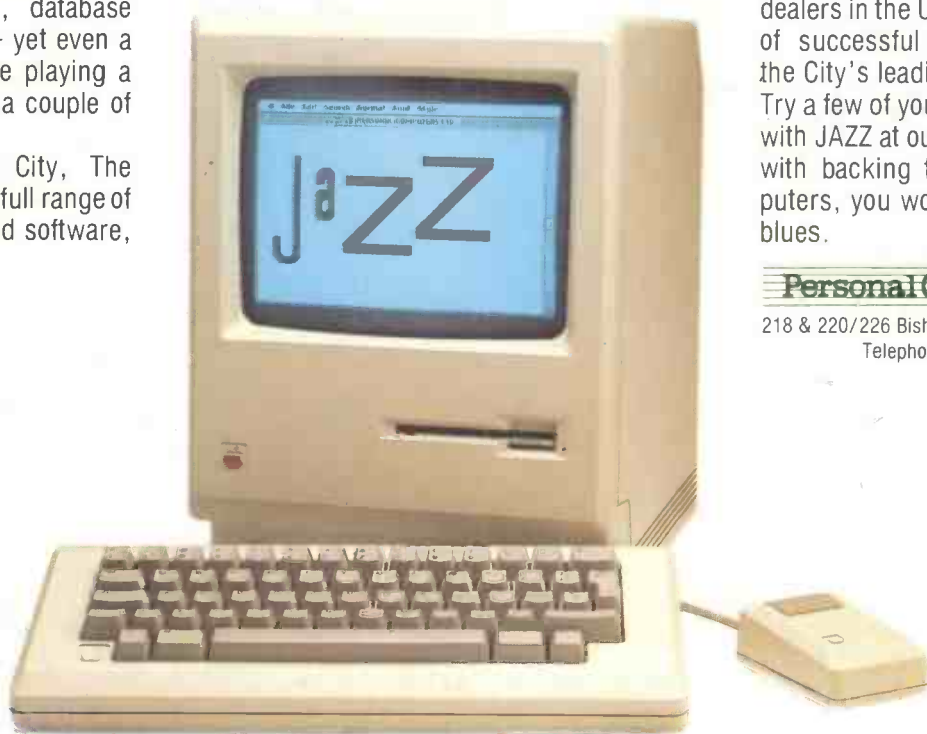

The Macintosh Centre

218 Bishopsgate, London EC2M 4JS. Telephone 01-377 2060