

You can get this game at [www.magic-play.eu](http://www.magic-play.eu)

**FUN4FOUR**  
GAMETABLE

**FUN4FOUR**

Hard- & Software Manual



➔ Better games through innovation

You can get this game at [www.magic-play.eu](http://www.magic-play.eu)

**T A B**  
A U S T R I A

# THANK YOU FOR CHOOSING FUN4FOUR



In order to get the maximum advantage out of the Fun4Four's features and ensure maximum performance and longevity, please read this manual carefully before operating the machine. Keep the manual in a safe place for future reference.

For additional help please contact our service line under **+43 7229 78040 250** or [hotline@tab.at](mailto:hotline@tab.at)

Please find additional information as download at: [www.tab.at/download](http://www.tab.at/download)

Fun4Four is a trademark of TAB Austria, © 1962 - 2015. All Rights Reserved - including any arisings from photomechanical reproduction and storage in electronic or any other medium, the system, cabinet, handbook and all components are subject to international copyright regulations.

All illustrations and descriptions within this manual are carefully considered, however, mistakes cannot be completely ruled out. The manufacturer don't accept legal responsibility of liability in any form with regard to errors in detail or any consequences that may arise from such problems. If you face any problems please get in contact with us.





We thank you for choosing



in preference to the vast number of other betting vending machines available on the market.

To gain satisfactory use from your *Go4Platinum*, please read the operating instructions thoroughly.

Please store this manual in such a way as to make it readily at hand if so required.

**WARNING!**

This is a Class A product – see [EC Declaration of Conformity](#). In a domestic environment this product may cause radio interference in which case the user may be required to take adequate measures.

For additional queries, our Hotline is at your service.

Call +43 / 72 29 / 78 0 40 – 250

Hardware instruction *Go4Platinum* machine manual.

(BG - 19.03.2015)

The text passages and illustrations contained within this document were put together with the greatest amount of care and attention, however, mistakes cannot be completely ruled out.

The manufacturer accepts no legal responsibility or liability in any form with regard to errors in detail, and any consequences that may arise from such errors.

The manufacturer is thankful for any suggestions for improvement or pointers leading to errors.

All rights - including any arising from photomechanical reproduction and storage in electronic or any other medium - are reserved. The program, handbook, and all components are subject to international copyright regulations.

© 1996 – 2015      TAB Austria  
4052 Ansfelden, Austria, Haider Strasse 40,  
Phone +43 (0) 7229 78 0 40, Fax +43 (0) 7229 78 6 60

All rights reserved.

→ Better games through innovation

TAB-Austria Industrie- und Unterhaltungselektronik GmbH & CoKG  
Haider Strasse 40, A-4052 Ansfelden, UID-Nr.: ATU57977639  
Tel. +43 (0)7229/78 040-0, Fax +43 (0)7229/78 660, e-mail: sales@tab.at, www.tab.at

The logo for TAB AUSTRIA, featuring a stylized blue and grey starburst icon above the letters 'TAB' in a large, bold, black font, with 'AUSTRIA' in a smaller, bold, black font below it, all contained within a blue rectangular border.

www.tab.at



## Table of content

<b>SETUP POINTERS</b> .....	<b>6</b>
<b>ADDITIONAL INFORMATION</b> .....	<b>7</b>
Definition of the key districts.....	7
<b>DESCRIPTION</b> .....	<b>8</b>
General.....	8
Operating equipment.....	8
<b>PC-SYSTEM COMPONENTS</b> .....	<b>8</b>
Standard equipment .....	8
<b>TECHNICAL DATA</b> .....	<b>9</b>
Machine-dimensions.....	9
Electronic Data Fun4Four.....	9
Component Data Fun4Four.....	10
<b>INSTALLATION</b> .....	<b>10</b>
<b>ALTERATION DESCRIPTION FOR SEAT POSITION</b> .....	<b>11</b>
<b>TEST MODE</b> .....	<b>14</b>
Menu General.....	15
Menu Basic Settings.....	17
Menu Machine Test.....	18
Menu Hardware Settings.....	19
Menu Bookkeeping.....	20
Menu Game Price Settings.....	21
Menu Games.....	22
Menu PIN Settings.....	23
ChampionsNet.....	24
Online Terminal Management .....	28
Activate Online Service .....	30
Supervisor Test mode.....	31
<b>PROGRAM UPDATE</b> .....	<b>32</b>
Update Options.....	32

→ Better games through innovation

TAB-Austria Industrie- und Unterhaltungselektronik GmbH & CoKG  
Halder Strasse 40, A-4052 Ansfelden, UID-Nr.: ATU57977639  
Tel. +43 (0)7229/78 040-0, Fax +43 (0)7229/78 660, e-mail: sales@tab.at, www.tab.at





Error messages .....	33
<b>TROUBLESHOOTING .....</b>	<b>34</b>
<b>MAINTENANCE OPERATING ELEMENTS.....</b>	<b>36</b>
Coin Acceptor.....	36
COMESTERO RM5HD .....	36
NRI G-13 MFT.....	38
Bill Acceptor.....	39
ASTRO GBA ST2 .....	39
JCM TAIKO PUB-7 .....	44
<b>WIRING DIAGRAM MAIN HARNESS.....</b>	<b>45</b>
<b>BLOCK DIAGRAM POWER CABLES.....</b>	<b>46</b>
<b>EXPLODED ASSEMBLY DRAWINGS .....</b>	<b>47</b>
Exploded Drawing FUN4FOUR .....	47
Assembly Base Section.....	48
Assembly Cash Box Section.....	49
Assembly PC Section Drawing.....	50
Assembly Table Section Drawing.....	51
Assembly Deposit Section Drawing.....	52
<b>EC DECLARATION OF CONFORMITY.....</b>	<b>53</b>
<b>END USER LICENSE AGREEMENT FOR MICROSOFT SOFTWARE.....</b>	<b>54</b>
<b>WARRANTY TERMS .....</b>	<b>58</b>
<b>NOTES .....</b>	<b>61</b>

→ Better games through innovation

TAB-Austria Industrie- und Unterhaltungselektronik GmbH & CoKG  
Haider Strasse 40, A-4052 Ansfelden, UID-Nr.: ATU57977639  
Tel. +43 (0)7229/78 040-0, Fax +43 (0)7229/78 660, e-mail: sales@tab.at, www.tab.at





## Setup Pointers

### Safety regulations for the user:

The machine should only be operated in a dry room and connected to a safety plug socket that complies with the relevant safety standards.

- Before starting the machine, it should be allowed to attain room temperature.
- Check the main voltage before connecting the machine!
- The machine is designed for an alternating voltage of 230 Volts (*or 115 Volts if specified on the type plate*), 50 Hz (*or 60 Hz*) and 180 W / 1,6A.
- The machine may only be operated with two 4 amp fuses.
- In case of damage to housing parts, protruding wires, machine fires or smashed picture tubes, the machine must be immediately switched off and the main plug disconnected.
- Defective or bare wire cables, especially power cables and plug connectors must be replaced.

### **IMPORTANT!**

**In such cases ensure that any machine contact is avoided and that it cannot be switched on!**

- The recommended ambient temperature is 5 – 35 Degrees on the Celsius scale.
- The recommended working temperature is 15 – 40 Degrees on the Celsius scale.
- The recommended absolute humidity is between 30% and 75% RG, not condensed.
- When positioned alongside other machines, interference in normal operation may occur.

Please pay attention to the [licensing terms and conditions of Microsoft](#).



**Disposal of Old Electrical & Electronic Equipment (Applicable in the European Union and other European countries with separate collection systems)**

This symbol on the product or on its packaging indicates that this product shall not be treated as household waste. Instead it shall be handed over to the applicable collection point for the recycling of electrical and electronic equipment. By ensuring this product is disposed of correctly, you will help prevent potential negative consequences for the environment and human health, which could otherwise be caused by inappropriate waste handling of this product. The recycling of materials will help to conserve natural resources. For more detailed information about recycling of this product, please contact your local city office, your household waste disposal service or the company where you purchased the product.

→ Better games through innovation

TAB-Austria Industrie- und Unterhaltungselektronik GmbH & CoKG  
Haider Strasse 40, A-4052 Ansfelden, UID-Nr.: ATU57977639  
Tel. +43 (0)7229/78 040-0, Fax +43 (0)7229/78 660, e-mail: sales@tab.at, www.tab.at





**IMPORTANT:**  
**When you work on the machine, you have to turn off the machine and plug out the voltage. Repairing activities on the machine only from qualified personal!**

In the inside of the machine there is a sticker (see below). Please inform the qualified personal before he begins to work.



### Additional Information

#### Definition of the key districts

KEY	DISTRICT	EMPLOYEE
Yellow	PC	Service engineer
White	Hardware components	Service engineer
Blue	Cash boxes	Cashier
Black		Unqualified employee

→ Better games through innovation

TAB-Austria Industrie- und Unterhaltungselektronik GmbH & CoKG  
 Halder Strasse 40, A-4052 Ansfelden, UID-Nr.: ATU57977639  
 Tel. +43 (0)7229/78 040-0, Fax +43 (0)7229/78 660, e-mail: sales@tab.at, www.tab.at



www.tab.at



## Description

### General

The „Fun4Four” is an ergonomically designed entertainment machine. The machine contains...

- an electronic coin acceptor
- an electronic banknote acceptor
- a 42” TFT LED display with touchscreen and
- a complete PC system

### Operating equipment

All games on the „Fun4Four!” will be played with the touchscreen.

## PC-System components

### Standard equipment

- PC-System with a CPU Dual Core 2,7GHz Trinity + 8GB DDR3 SODIMM memory
- On-Board graphic card (1920 x 1080 resolution, **FULL HD**)
- Minimum 250 GB SATA hard disk drive or minimum 60 GB SSD
- TAB I/O interface card with safety-memory
- 42” TFT-display with touchscreen
- Electronic coin acceptor
- Electronic banknote acceptor

→ Better games through innovation

TAB-Austria Industrie- und Unterhaltungselektronik GmbH & CoKG  
Haider Strasse 40, A-4052 Ansfelden, UID-Nr.: ATU57977639  
Tel. +43 (0)7229/78 040-0, Fax +43 (0)7229/78 660, e-mail: sales@tab.at, www.tab.at



[www.tab.at](http://www.tab.at)





## Technical Data

### Machine-dimensions

	unpacked	packed
Depth	79,8 cm	80 cm
Width	118,5 cm	120 cm
Height	106 cm	124 cm
Weight	137 kg	171 kg

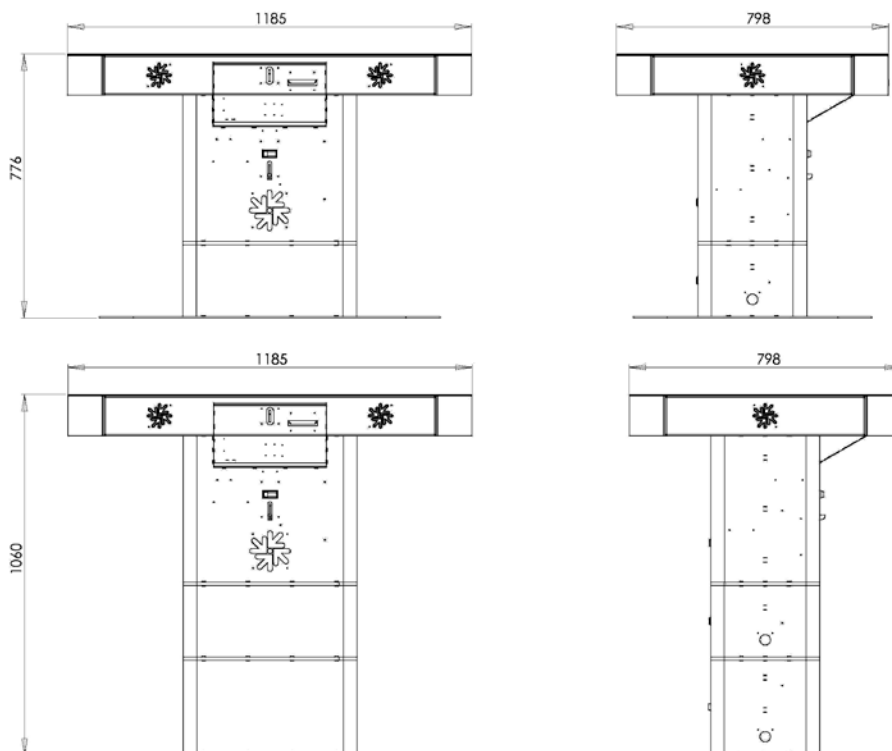

### Electronic Data Fun4Four

<u>Electricity:</u>	230 volt
<u>Performance:</u>	180 watt
<u>Cutout:</u>	2x 4 ampere

### Note:

When you have more than one machine on a voltage splitter please note:  
With a normal installed electricity port with a cutout from 16 ampere do not plug in more than 3 machines.

→ Better games through innovation

TAB-Austria Industrie- und Unterhaltungselektronik GmbH & CoKG  
Haider Strasse 40, A-4052 Ansfelden, UID-Nr.: ATU57977639  
Tel. +43 (0)7229/78 040-0, Fax +43 (0)7229/78 660, e-mail: sales@tab.at, www.tab.at





## Component Data Fun4Four

- 42" Multi touch screen
  - 42" TFT LED display
- Resolution: 1920 x 1080 Full HD

## Installation

Every machine is factory tested and delivered in a preset condition.

We recommend you wait for 15 minutes, so that the display can attain optimum operating temperature.

Due to the effects of temperature, it is possible that the display and touch-screen settings become altered. Therefore, we recommend the following procedure **ALWAYS** be adhered to when commissioning the machine for the first time:

1. Turn on the machine  
The on/off switch is inside the machine (PC door).  
The game menu will be automatically started.
2. Open the front door and push the test mode button  
The test mode starts and will be shown on the display.
3. Calibrate the touchscreen  
In the menu „General" there is a button “Calibrate”, click the button and follow the instructions on the screen.
4. Volume settings  
In the test mode option „General" you can set the desired volume for playing and for standby.
5. End test mode  
With the button „Back" you will go back to the main menu of the test mode.  
When you click the „Back" button again, the game menu will start automatically.

→ Better games through innovation

TAB-Austria Industrie- und Unterhaltungselektronik GmbH & CoKG  
Haider Strasse 40, A-4052 Ansfelden, UID-Nr.: ATU57977639  
Tel. +43 (0)7229/78 040-0, Fax +43 (0)7229/78 660, e-mail: [sales@tab.at](mailto:sales@tab.at), [www.tab.at](http://www.tab.at)





## Alteration description for seat position

1. Disconnect the machine from electricity.
2. Open the middle and the bottom box.



3. Disconnect the power cable, which goes through the bottom box, and thread it to the middle box.
4. Disconnect the LED lights.
5. Open the 4 screws, which jointing the bottom box and the middle box.

**WARNING: The Fun4Four is now slackly, be careful!**



→ Better games through innovation

TAB-Austria Industrie- und Unterhaltungselektronik GmbH & CoKG  
Halder Strasse 40, A-4052 Ansfelden, UID-Nr.: ATU57977639  
Tel. +43 (0)7229/78 040-0, Fax +43 (0)7229/78 660, e-mail: sales@tab.at, www.tab.at





6. Lift the Fun4Four up and remove the bottom box. (see picture)



7. Open all 4 screw nuts which connect the bottom box with the baseplate.



8. Remove the bottom box and set the Fun4Four now on the baseplate.

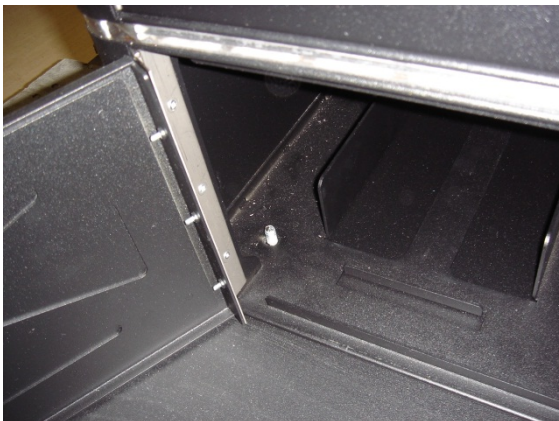

→ Better games through innovation

TAB-Austria Industrie- und Unterhaltungselektronik GmbH & CoKG  
Halder Strasse 40, A-4052 Ansfelden, UID-Nr.: ATU57977639  
Tel. +43 (0)7229/78 040-0, Fax +43 (0)7229/78 660, e-mail: sales@tab.at, www.tab.at







9. Now pull all 4 screw nuts.

10. Put the power cable through the hole (see picture) and connect it to electricity.



→ Better games through innovation

TAB-Austria Industrie- und Unterhaltungselektronik GmbH & CoKG  
Halder Strasse 40, A-4052 Ansfelden, UID-Nr.: ATU57977639  
Tel. +43 (0)7229/78 040-0, Fax +43 (0)7229/78 660, e-mail: [sales@tab.at](mailto:sales@tab.at), [www.tab.at](http://www.tab.at)



[www.tab.at](http://www.tab.at)



## Test mode

- Push button for test mode in the inside of the machine

You will get in this menu:

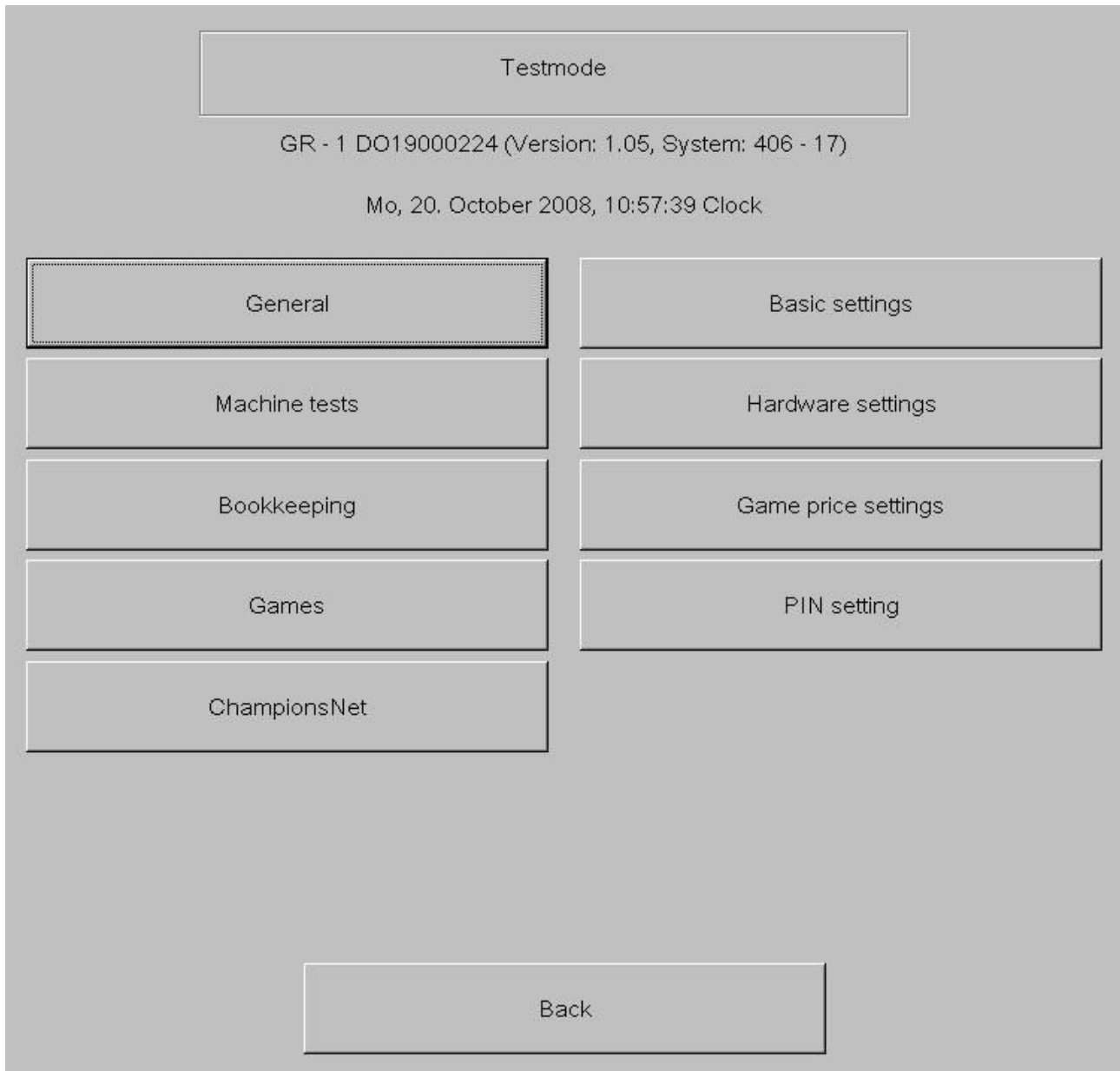

→ Better games through innovation

TAB-Austria Industrie- und Unterhaltungselektronik GmbH & CoKG  
Halder Strasse 40, A-4052 Ansfelden, UID-Nr.: ATU57977639  
Tel. +43 (0)7229/78 040-0, Fax +43 (0)7229/78 660, e-mail: sales@tab.at, www.tab.at





## Menu General

Adjust volume

Game 30

Standby 30

Without external volume control

Erase

Erase credit

Erase highscore

MASTER RESET

Other

Test credit

Adjust Touch-Screen

Calibration

Back

- **Ajust volume**
  - Game  
Set the volume of the game sound
  - Stand-By  
Set the volume of the stand-by sound
- **Set-up touchscreen**
  - Calibrate  
Here you can calibrate the touchscreen (follow the settings on the display)

→ Better games through innovation

TAB-Austria Industrie- und Unterhaltungselektronik GmbH & CoKG  
Halder Strasse 40, A-4052 Ansfelden, UID-Nr.: ATU57977639  
Tel. +43 (0)7229/78 040-0, Fax +43 (0)7229/78 660, e-mail: sales@tab.at, www.tab.at





- **Delete**
  - Erase credits  
Delete existing credit(s)
  - Delete high score  
Delete all high score lists on the machine
  - Master Reset  
This option will set the machine back to factory settings
  
- **Other**
  - Test credit  
Set test-credits

→ Better games through innovation

TAB-Austria Industrie- und Unterhaltungselektronik GmbH & CoKG  
Halder Strasse 40, A-4052 Ansfelden, UID-Nr.: ATU57977639  
Tel. +43 (0)7229/78 040-0, Fax +43 (0)7229/78 660, e-mail: [sales@tab.at](mailto:sales@tab.at), [www.tab.at](http://www.tab.at)



[www.tab.at](http://www.tab.at)





## Menu Basic Settings

Date and time

Day       Month       Year

Hour       Minute

Basic language

Automatically delete high score

never     

every      4      week(s)     

individually for each entry

- **Date and time**

Here you can set up the date and the time.

Note:

A machine which is active in the ChampionsNet, will set the date and the time automatically. You only need to set the correct time zone.

- **Basic language**

Language options are automatically displayed on the main menu when the machine is powered on.

- **Automatically delete high score**

Here you decide if and how often the local high score will be erased.

→ Better games through innovation

TAB-Austria Industrie- und Unterhaltungselektronik GmbH & CoKG  
Halder Strasse 40, A-4052 Ansfelden, UID-Nr.: ATU57977639  
Tel. +43 (0)7229/78 040-0, Fax +43 (0)7229/78 660, e-mail: sales@tab.at, www.tab.at





## Menu Machine Test

<ul style="list-style-type: none"><li>[-] Device 411f - Unknown<ul style="list-style-type: none"><li>[+] Channel 0, EUR 0.00: 0</li></ul></li><li>[-] Device 4e20 - Coins<ul style="list-style-type: none"><li>[+] Channel 0, EUR 0.10: 0</li><li>[+] Channel 1, EUR 0.20: 0</li><li>[+] Channel 2, EUR 0.50: 0</li><li>[+] Channel 3, EUR 1.00: 0</li><li>[+] Channel 4, EUR 2.00: 0</li></ul></li><li>[-] Device 4e21 - Bank notes<ul style="list-style-type: none"><li>[+] Channel 0, EUR 5.00: 0</li><li>[+] Channel 1, EUR 10.00: 0</li><li>[+] Channel 2, EUR 20.00: 0</li><li>[+] Channel 3, EUR 50.00: 0</li><li>[+] Channel 4, EUR 100.00: 0</li><li>[+] Channel 5, EUR 200.00: 0</li></ul></li></ul>	<p>Meters</p> <div style="border: 1px solid gray; padding: 5px; text-align: center;">Total In</div> <p>Insert</p> <div style="border: 1px solid gray; padding: 5px;">EUR 0,00</div> <p>Credit <span style="float: right;">0</span></p>
<p>Last impulses:</p> <div style="border: 1px solid gray; height: 80px; width: 100%;"></div>	
<p>Button press:</p> <div style="border: 1px solid gray; padding: 2px;">None</div>	<div style="border: 1px solid gray; padding: 5px; text-align: center; width: 100px; margin: 0 auto;">Back</div>

- Coins:** Test if the coin channels are working correctly
- Banknotes:** Test if the banknote channels are working correctly
- Last Impulses:** View the correct allocation of your coin acceptor and banknote reader.
- Button press:** Test if your buttons are working properly
- Meters:** Check the hardware counter. There should be 10 impulses already added onto the counter.

→ Better games through innovation

TAB-Austria Industrie- und Unterhaltungselektronik GmbH & CoKG  
Haider Strasse 40, A-4052 Ansfelden, UID-Nr.: ATU57977639  
Tel. +43 (0)7229/78 040-0, Fax +43 (0)7229/78 660, e-mail: sales@tab.at, www.tab.at





## Menu Hardware Settings

Device 411f - Unknown

- Channel 0, EUR 0.00

Device 4e20 - Coins

- Channel 0, EUR 0.10
- Channel 1, EUR 0.20
- Channel 2, EUR 0.50
- Channel 3, EUR 1.00
- Channel 4, EUR 2.00

Device 4e21 - Bank notes

- Channel 0, EUR 5.00
- Channel 1, EUR 10.00
- Channel 2, EUR 20.00
- Channel 3, EUR 50.00
- Channel 4, EUR 100.00
- Channel 5, EUR 200.00

Meter impulse:

Counter 1	EUR 0.10
-----------	----------

Buttons: +0.001, -0.001, +0.01, -0.01, +0.1, -0.1, +1, -1, +10, -10, +100, -100, Currency, Apply, Back

- **Currency**  
Choose the programmed currency
- **Meter impulse**  
Set the impulses for the hardware counter
- **Set VDAI**  
Set the options for VDAI (only in Germany)
- **Coins and banknotes**  
Complete setup of the coin and banknote reader channels

→ Better games through innovation

TAB-Austria Industrie- und Unterhaltungselektronik GmbH & CoKG  
 Halder Strasse 40, A-4052 Ansfelden, UID-Nr.: ATU57977639  
 Tel. +43 (0)7229/78 040-0, Fax +43 (0)7229/78 660, e-mail: sales@tab.at, www.tab.at





## Menu Bookkeeping

Tu, 14. October 2008, 15:21:29 GMT -  
Mo, 20. October 2008, 9:59:58 GMT

<table style="width: 100%; border-collapse: collapse;"> <tr> <td style="text-align: left;">0.10</td> <td style="text-align: right;">0</td> </tr> <tr> <td style="text-align: left;">0.20</td> <td style="text-align: right;">0</td> </tr> <tr> <td style="text-align: left;">0.50</td> <td style="text-align: right;">4</td> </tr> <tr> <td style="text-align: left;">1.00</td> <td style="text-align: right;">1</td> </tr> <tr> <td style="text-align: left;">2.00</td> <td style="text-align: right;">0</td> </tr> </table> <p>Coins <span style="float: right;">3.00</span></p> <table style="width: 100%; border-collapse: collapse;"> <tr> <td style="text-align: left;">5.00</td> <td style="text-align: right;">0</td> </tr> <tr> <td style="text-align: left;">10.00</td> <td style="text-align: right;">0</td> </tr> <tr> <td style="text-align: left;">20.00</td> <td style="text-align: right;">0</td> </tr> <tr> <td style="text-align: left;">50.00</td> <td style="text-align: right;">0</td> </tr> <tr> <td style="text-align: left;">100.00</td> <td style="text-align: right;">0</td> </tr> <tr> <td style="text-align: left;">200.00</td> <td style="text-align: right;">0</td> </tr> </table> <p>Bank notes <span style="float: right;">0.00</span></p> <hr/> <p>Total In <span style="float: right;">3.00</span></p>	0.10	0	0.20	0	0.50	4	1.00	1	2.00	0	5.00	0	10.00	0	20.00	0	50.00	0	100.00	0	200.00	0	<p style="text-align: center;">Result</p> <p>Currency <span style="float: right;">EUR</span></p> <p>Total In <span style="float: right;">3.00</span></p> <p>Total Out <span style="float: right;">0.00</span></p> <hr/> <p style="text-align: right;">3.00</p> <p>Test credits: <span style="float: right;">0</span></p> <p>Free game credits: <span style="float: right;">0</span></p> <p>Time running <span style="float: right;">132:02</span></p> <p>Time played <span style="float: right;">2:30</span></p> <div style="text-align: center; margin-top: 20px;"> <p>Bookkeeping 2</p> <p>Erase</p> <p>Back</p> </div>
0.10	0																						
0.20	0																						
0.50	4																						
1.00	1																						
2.00	0																						
5.00	0																						
10.00	0																						
20.00	0																						
50.00	0																						
100.00	0																						
200.00	0																						

Bookkeeping visible in the overview test menu

Above is the complete bookkeeping menu of the machine. If desired, set the bookkeeping available for the supervisor PIN code.

- **Bookkeeping 1**  
Here you can see the complete income of coins, banknotes and Bonus-card inputs. You also can see the complete sum of all the credits and the running time of the machine.
- **Bookkeeping 2**  
Here you can see an overview of the income, test-credits, music-credits and the running time.

Please note:

Bookkeeping 1 and Bookkeeping 2 can be deleted separately.

→ Better games through innovation

TAB-Austria Industrie- und Unterhaltungselektronik GmbH & CoKG  
Haider Strasse 40, A-4052 Ansfelden, UID-Nr.: ATU57977639  
Tel. +43 (0)7229/78 040-0, Fax +43 (0)7229/78 660, e-mail: sales@tab.at, www.tab.at



[www.tab.at](http://www.tab.at)





## Menu Game Price Settings

Game price setting

Money value	Credit	Currency
0.50	1	EUR

Introduce

Delete

+0,001	-0,001
+0,01	-0,01
+0,1	-0,1
+1	-1
+10	-10
+100	-100

Standard1 (normal)

Standard2 (Bonus)

Free play mode

Apply

Back

- **Game price setting**  
Set here your balance of the credit. The standard price is 50 Cents for 1 credit. The Standard2 (Bonus) menu allows you to set special credits for Bonus-options
- **Free play mode**  
In this mode, the machine always has 99 credits in the menu.

→ Better games through innovation

TAB-Austria Industrie- und Unterhaltungselektronik GmbH & CoKG  
Haider Strasse 40, A-4052 Ansfelden, UID-Nr.: ATU57977639  
Tel. +43 (0)7229/78 040-0, Fax +43 (0)7229/78 660, e-mail: sales@tab.at, www.tab.at





## Menu Games

	Game	Credit	Continue Credit	Degree of difficulty	
Colonies	on	1	1	average	▲
Texas Hold'em	on	1	1	average	
BlackJack Battle	on	1	1	average	
BlackJack	on	1	1	average	
Web Browser	off	1	1	average	
FindIt Girls	off	1	1	average	
Kniffel	off	1	1	average	
Knock Off Poker	on	1	1	average	▼

Game setting

Colonies

Game

on

off

Game price

1

credit(s)

+1    Default

-1

Game-degree of difficulty

easy

average

difficult

Continue Price

1

credit(s)

+1    Default

-1

Statistic

Selected game

All games

Apply

Back

- It's possible to view the game statistic, separate for one game or from the whole machine
- Furthermore you can set the credit settings for each game unique, and also separate for the start of the game or the continue
- In this menu you can also disable games

→ Better games through innovation

TAB-Austria Industrie- und Unterhaltungselektronik GmbH & CoKG  
 Halder Strasse 40, A-4052 Ansfelden, UID-Nr.: ATU57977639  
 Tel. +43 (0)7229/78 040-0, Fax +43 (0)7229/78 660, e-mail: sales@tab.at, www.tab.at





## Menu PIN Settings

Select the PIN number to be changed and then enter the new PIN number!

set PIN for

Supervisor 1	****	change
<input type="checkbox"/> activate		
Supervisor 2	****	change
<input type="checkbox"/> activate		
Supervisor 3	****	change
<input type="checkbox"/> activate		

set PIN for

Testmode	****	change
<input type="checkbox"/> activate		

set PIN for

Bookkeeping 2	****	change
<input type="checkbox"/> activate		

Back

- Set up 3 different Supervisor Pins for a access to a special test mode, where you can see special menus.
- Set up a Pin for entering the test mode.
- Set up a Pin code for the access to delete the Bookkeeping 2.

→ Better games through innovation

TAB-Austria Industrie- und Unterhaltungselektronik GmbH & CoKG  
Haider Strasse 40, A-4052 Ansfelden, UID-Nr.: ATU57977639  
Tel. +43 (0)7229/78 040-0, Fax +43 (0)7229/78 660, e-mail: sales@tab.at, www.tab.at





## ChampionsNet

In the menu ChampionsNet you can set up the internet settings and register the Fun4Four by TAB – Austria.

Machine/Set-up site	
Machine number	0
Name of the establishment	F4F Bar
Place/Town	4052 Ansfelden
Address	Haiderstrasse 40
Telephone number	
Fax number	
Email	
Country	Austria
<input type="button" value="change"/>	
Connection (Network - Direct)	
Telephone number	
User name	
Time	18:20
<input type="button" value="change"/>	
<input type="button" value="www"/>	<input type="button" value="Test connection"/>
<input type="button" value="Register ..."/>	
<input type="button" value="Receive data"/>	
<input type="button" value="Receive all data"/>	
<input checked="" type="checkbox"/> activate	<input type="button" value="Protocol"/>
	<input type="button" value="Back"/>

- o Activate ChampionsNet

→ Better games through innovation

TAB-Austria Industrie- und Unterhaltungselektronik GmbH & CoKG  
Haider Strasse 40, A-4052 Ansfelden, UID-Nr.: ATU57977639  
Tel. +43 (0)7229/78 040-0, Fax +43 (0)7229/78 660, e-mail: sales@tab.at, www.tab.at



www.tab.at



Choose „change” at the „Connection“ and you will come to this menu:

- **Provider connection:**
  - Setup the telephone number, user name and password for your connection.
- **Start of transmission**
  - Set the time of the automatically daily-transfer of the ChampionsNet data.

Provider connection		
Telephone number	<input type="text"/>	<input type="button" value="change"/>
User name	<input type="text"/>	<input type="button" value="change"/>
Password	<input type="text"/>	<input type="button" value="change"/>
Confirmation	<input type="text"/>	<input type="button" value="change"/>
Start of transmission		
<input checked="" type="radio"/> Hour	<input type="radio"/> Minute	<input type="button" value="+"/>
<input type="text" value="18"/>	<input type="text" value="20"/>	<input type="button" value="-"/>
Connection		
<input type="radio"/> Modem		
<input checked="" type="radio"/> Network - Direct		
<input type="radio"/> Network - VPN		
<input type="radio"/> Network - PPPOE		
<input checked="" type="checkbox"/> Permanent Connection		
<input type="button" value="Page 2..."/>		
<input type="button" value="Apply"/>		
<input type="button" value="Back"/>		

→ Better games through innovation

TAB-Austria Industrie- und Unterhaltungselektronik GmbH & CoKG  
Halder Strasse 40, A-4052 Ansfelden, UID-Nr.: ATU57977639  
Tel. +43 (0)7229/78 040-0, Fax +43 (0)7229/78 660, e-mail: sales@tab.at, www.tab.at







o **Connection Type**

Choose your internet connection. If you choose “Permanent connection”, the machine is always connected to the internet. This is not recommended, because then you can have high internet costs.

• **Network Direct (intern network)**

There is your device in a intern network. You don't need any data like telephone number or password. You need only the settings on **page 2**.

Choose the connection **Network Direct** and click the button **Page 2** (see **picture 1.0**). For this data, please connect your network administrator and fill it in.

• **Network – VPN**

Users of ADSL have to choose this option. You get your internet setup data from your provider like number, username and password. Choose the connection **Network – VPN** and fill in the data. Then go on **page 2 (picture 1.0)** and there you make the following settings:

- De-activate **Disable DNS**
- Fill in DNS 1
- Fill in DNS 2
- De-activate **Use DHCP**
- Fill in IP-address
- Fill in Subnet Mask

All this data you get from your internet provider.

• **Network – PPPOE (tie internet)**

Users of TDSL or higher are using this option! You get your internet setup datas from your provider like number, username and password. Choose the connection **Network – PPPOE** and fill in the data. Then go on **page 2 (picture 1.0)** and there you make the following settings:

- Activate **Disable DNS**
- De-activate **Use DHCP**
- Fill in IP-address
- Fill in Subnet Mask

All this data you get from your internet provider.

You are able to connect more machines together and then connect them into the internet. What you need for this is a **hardware router** which is establishing the internet connection for example via DSL. With the network card on-board you configure a local network (see settings **Network Direct**). The PCs will be connected to the router, and the router to the DSL connection.

→ Better games through innovation

TAB-Austria Industrie- und Unterhaltungselektronik GmbH & CoKG  
Haider Strasse 40, A-4052 Ansfelden, UID-Nr.: ATU57977639  
Tel. +43 (0)7229/78 040-0, Fax +43 (0)7229/78 660, e-mail: sales@tab.at, www.tab.at





**Page 2** of the menu **Provider connection:**

Picture 1.0

Proxy/Auto Configuration Script

Enable Proxy:   
change

Enable Config Script:   
change

DNS

Disable DNS

Domain:  change

DNS1:  change

DNS2:  change

Network Info

Use DHCP

IP Address:  change

Subnet Mask:  change

Gateway:  change

Apply Back

Fill in here your internet settings. Please contact your internet provider or network administrator when you have problems.

→ Better games through innovation

TAB-Austria Industrie- und Unterhaltungselektronik GmbH & CoKG  
Halder Strasse 40, A-4052 Ansfelden, UID-Nr.: ATU57977639  
Tel. +43 (0)7229/78 040-0, Fax +43 (0)7229/78 660, e-mail: sales@tab.at, www.tab.at





## Online Terminal Management

With the ONLINE TERMINAL MANAGEMENT you are able to advise your machines from your home!

With the Online Terminal Management Homepage you can do a lot of options with one mouse click:

- **Online Service**  
See important data from your machines at every time.
- **Terminal and license management**  
Here you can manage all your terminals and update your Version online

You can directly register at <https://service.championsnet.net> or [www.tab.at/otm](http://www.tab.at/otm)

If you register at your first time, you will get your licenses for the first 3 months for free, with the licenses you can activate Online Service.

→ Better games through innovation

TAB-Austria Industrie- und Unterhaltungselektronik GmbH & CoKG  
Haider Strasse 40, A-4052 Ansfelden, UID-Nr.: ATU57977639  
Tel. +43 (0)7229/78 040-0, Fax +43 (0)7229/78 660, e-mail: [sales@tab.at](mailto:sales@tab.at), [www.tab.at](http://www.tab.at)



[www.tab.at](http://www.tab.at)



When all settings are done, you have to **register** your machine into the ChampionsNet.

Machine/Set-up site

Machine number	0
Name of the establishment	F4F Bar
Place/Town	4052 Ansfelden
Address	Haiderstrasse 40
Telephone number	
Fax number	
Email	
Country	Austria

Connection (Network - Direct)

Telephone number	
User name	
Time	18:20

activate

In the registration procedure, the machine is getting accounted to the ChampionsNet server and gets it owns machine number.

For the feature Online Service, you must register at our homepage under OTM and get your own Tan list and licenses. The licenses are free for 1 months.

Then in the **test mode** the button **Online Service** is available. Activate Online Service by clicking the button, agree the provisions and fill in a TAN – code.

→ Better games through innovation

TAB-Austria Industrie- und Unterhaltungselektronik GmbH & CoKG  
Haider Strasse 40, A-4052 Ansfelden, UID-Nr.: ATU57977639  
Tel. +43 (0)7229/78 040-0, Fax +43 (0)7229/78 660, e-mail: sales@tab.at, www.tab.at

www.tab.at



## Activate Online Service

Testmode

GR - 1 DO19000224 (Version: 1.05, System: 406 - 17)

Mo, 20. October 2008, 10:57:39 Clock

General	Basic settings
Machine tests	Hardware settings
Bookkeeping	Game price settings
Games	PIN setting
ChampionsNet	
Online Service	

Back

Choose „**Online Service**“.

Follow the instructions on the screen and fill in your **Tan code**, device **number (GE....)** and the current stand of your **counter**.

→ Better games through innovation

TAB-Austria Industrie- und Unterhaltungselektronik GmbH & CoKG  
Halder Strasse 40, A-4052 Ansfelden, UID-Nr.: ATU57977639  
Tel. +43 (0)7229/78 040-0, Fax +43 (0)7229/78 660, e-mail: sales@tab.at, www.tab.at







## Supervisor Test mode

The Supervisor test mode allows you as owner of the machine to give your customer a reduced version of the test mode without a machine key.

You can reach this test mode in the main menu – Info – click Fun4Four logo. After entering the pin code you will see the following screen (pin code has to be set in the test mode for **supervisor 1**)

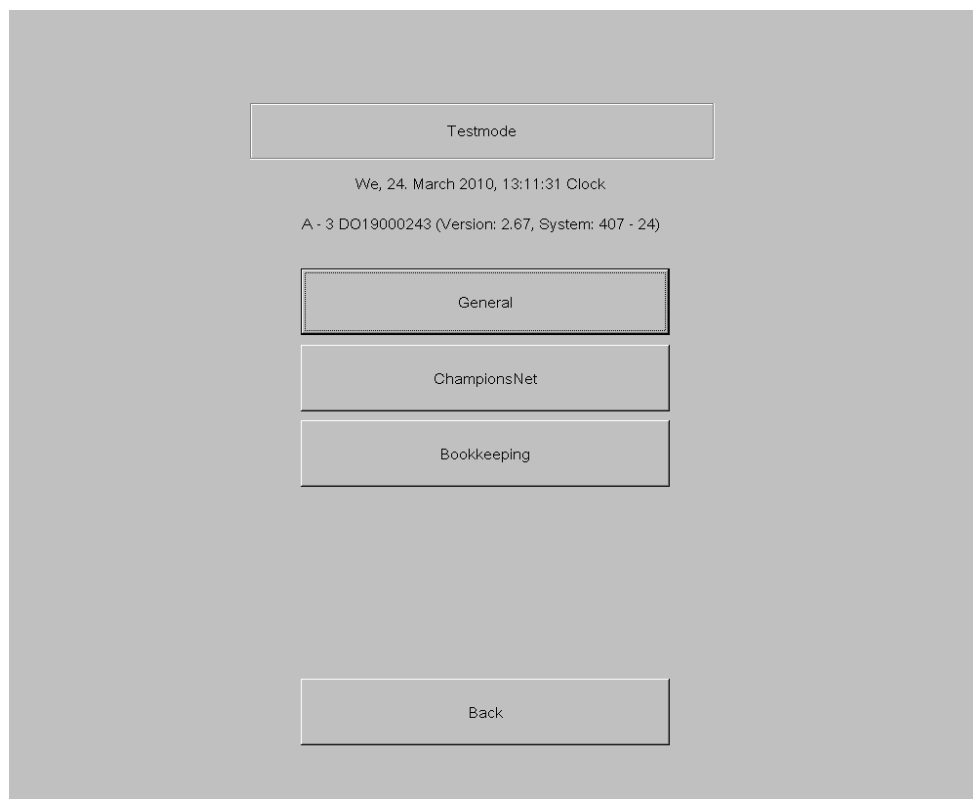

The customer has the possibility to change a few settings (volume of the machine, data receive, **show bookkeeping -> he can't delete it**)





## Program Update

Every machine you get has the latest version and standard settings. If you want always the latest version you must make an update or register the machine to OTM.

### Procedure

- Switch machine off
- Dock the update HDD to the plug connector of the PC
- Switch machine on
- Copy procedure is starting automatically; this is taking about 15 – 30 minutes.
- Turn machine off at final message *“Update finished – Please switch off, remove update disk and switch on again“*
- Remove the update disk
- Turn off the machine again
- All data on the HDD will be scanned and checked.
- Machine starts now with new software

### Note:

You can choose different options before the update starts.

For further information, read the description „Update Options“.

### Update Options

If you have plugged in the update disk, you can choose the following options before the update starts:

- Force partitioning  
Format the hard disk drive
- No Backup and Restore  
If you choose this option, there is no backup from game data.

→ Better games through innovation

TAB-Austria Industrie- und Unterhaltungselektronik GmbH & CoKG  
Haider Strasse 40, A-4052 Ansfelden, UID-Nr.: ATU57977639  
Tel. +43 (0)7229/78 040-0, Fax +43 (0)7229/78 660, e-mail: sales@tab.at, www.tab.at



[www.tab.at](http://www.tab.at)



## Error messages

Various error messages may appear during the copying procedure. The possible messages are listed below:

<b>Störung</b>	<b>Fehlerursache</b>	<b>Abhilfe</b>
HARDLOCK DONGLE NOT CONNECTED	■ The dongle must be connected for the copying procedure.	■ Check dongle connection.
WRONG DONGLE CONNECTED	■ Wrong dongle connected.	■ Check dongle connection.
UNKNOWN CONFIGURATION	■ The update hard disk does not support the device configuration.	■ Please have it checked by TAB.
OVERWRITE PROTECTION	■ Check the hard disk set-up.	■ Otherwise please have it checked by TAB.
PARTITION ERROR	■ The hard disk to be updated cannot be set up.	■ Either the hard disk or its cable is defective.
MASTERDISK ERROR	■ An error has occurred accessing the update stick.	■ The Update-Stick is defective.
SLAVEDISK ERROR	■ An error accessing the hard disk to be updated has occurred.	■ Either the hard disk or its cable is defective.
MASTER COPY FILES ERROR	■ An error reading the update hard disk has occurred.	■ The Update-Stick is defective.
SLAVE COPY FILES ERROR	■ An error has occurred writing to the hard disk to be updated.	Either the hard disk or its cable is defective.
NOT COMPLETELY UPDATED	■ The update procedure has not been completed.	■ The update procedure must be repeated.
CHECK FILES ERROR	■ The hard disk content does not correspond to the specifications. Carry out update to correct.	■ If the error occurs immediately after updating, either the hard disk or its cable is defective.

→ Better games through innovation

TAB-Austria Industrie- und Unterhaltungselektronik GmbH & CoKG  
Haider Strasse 40, A-4052 Ansfelden, UID-Nr.: ATU57977639  
Tel. +43 (0)7229/78 040-0, Fax +43 (0)7229/78 660, e-mail: sales@tab.at, www.tab.at





## Troubleshooting

Fault	Cause	Remedy
Touch screen only functions partly.	<ul style="list-style-type: none"> <li>■ Connection cable from touch screen to PC defective (the part that is connected to the PC).</li> </ul>	<ul style="list-style-type: none"> <li>■ Replace connection cable.</li> </ul>
MEMORY TEST FAIL at start-up.	<ul style="list-style-type: none"> <li>■ Memory defective.</li> </ul>	<ul style="list-style-type: none"> <li>■ Replace PC.</li> </ul>
White screen	<ul style="list-style-type: none"> <li>■ Graphic card defect.</li> </ul>	<ul style="list-style-type: none"> <li>■ Replace the graphic card</li> </ul>
Touch screen does not work after exchanging the PC	<ul style="list-style-type: none"> <li>■ Possibly not calibrated.</li> </ul>	<ul style="list-style-type: none"> <li>■ Calibrate the touch screen (press red button on the machine, go to operator mode).</li> </ul>
Touch screen cannot be calibrated properly	<ul style="list-style-type: none"> <li>■ Missing data in touch controller buffer.</li> </ul>	<ul style="list-style-type: none"> <li>■ Change touch screen controller or the complete touch</li> </ul>
Touch screen does not work and/or LED on the rear side of the PC is flashing	<ul style="list-style-type: none"> <li>■ Touch screen controller or</li> <li>■ Touch screen cable is defect.</li> </ul>	<ul style="list-style-type: none"> <li>■ Check cable between touch screen and controller, exchange defect controller or exchange PC.</li> </ul>
No function	<ul style="list-style-type: none"> <li>■ The main plug is not plugged in.</li> <li>■ The main switch is not on.</li> <li>■ Fuse is burnt.</li> </ul>	<ul style="list-style-type: none"> <li>■ Plug in main plug.</li> <li>■ Switch on main switch.</li> <li>■ Install new fuse.</li> </ul>
No picture	<ul style="list-style-type: none"> <li>■ Net cable not connected to monitor.</li> <li>■ Video connection not plugged in.</li> <li>■ Monitor defect.</li> </ul>	<ul style="list-style-type: none"> <li>■ Check power supply of monitor and connections.</li> <li>■ Plug in video connections.</li> <li>■ Exchange monitor.</li> </ul>
No sound	<ul style="list-style-type: none"> <li>■ Volume controller is not turned on.</li> <li>■ Audio cable is not connected</li> <li>■ Loudspeaker defect.</li> </ul>	<ul style="list-style-type: none"> <li>■ Turn up volume.</li> <li>■ Plug in audio cable.</li> <li>■ Exchange loudspeaker.</li> </ul>

→ Better games through innovation

TAB-Austria Industrie- und Unterhaltungselektronik GmbH & CoKG  
 Halder Strasse 40, A-4052 Ansfelden, UID-Nr.: ATU57977639  
 Tel. +43 (0)7229/78 040-0, Fax +43 (0)7229/78 660, e-mail: sales@tab.at, www.tab.at





Fault	Cause	Remedy
Coins are counted wrongly	<ul style="list-style-type: none"> <li>■ Wrong value programmed</li> </ul>	<ul style="list-style-type: none"> <li>■ Check program setup</li> </ul>
Inserted coins fall through	<ul style="list-style-type: none"> <li>■ No power at coin acceptor</li> <li>■ Dirty coin acceptor</li> <li>■ Coin channel not programmed</li> <li>■ Coin acceptor defect</li> </ul>	<ul style="list-style-type: none"> <li>■ Check power supply</li> <li>■ Clean coin acceptor</li> <li>■ Change programming</li> <li>■ Exchange coin acceptor</li> </ul>
Low coin acceptance	<ul style="list-style-type: none"> <li>■ Coin acceptor is dirty</li> </ul>	<ul style="list-style-type: none"> <li>■ Clean coin acceptor</li> </ul>
Low bill acceptance	<ul style="list-style-type: none"> <li>■ Bill reader is de-calibrated</li> </ul>	<ul style="list-style-type: none"> <li>■ Calibrate bill-reader</li> </ul>
Error message on the screen "Program Error (hard disc)", no more credits will be accepted; no more action is possible from the player; operator invention is required!	<ul style="list-style-type: none"> <li>■ Integrity check at startup failed.</li> </ul>	<ul style="list-style-type: none"> <li>■ An update has to be performed with an update disk with the same version by an authorized person.</li> </ul> <p>After that the Critical Memory will be restored from the data's in the FRAM (if they are correct) to the hard disk.</p> <p>If the error remains, the hard disk is defect and must be changed (see below).</p>
In this case, mostly the machine will not work anyway.	<ul style="list-style-type: none"> <li>■ Hardware error of HDD</li> </ul>	<ul style="list-style-type: none"> <li>■ Hard disk have to be changed by an authorized person only with a hard disk containing the same version or with a new hard disk but then an update has to be performed on the machine with an update disk containing the same version.</li> </ul> <p>After that the Critical Memory will be restored from the data's in the FRAM (if they are correct) to the hard disk.</p>
A "blue screen" will be shown and the machine stops immediately.	<ul style="list-style-type: none"> <li>■ Hardware error of FRAM</li> </ul>	<ul style="list-style-type: none"> <li>■ I/O Controller card have to be changed by an authorized person only.</li> </ul> <p>After that the "Critical Memory" will be restored from the data's on the hard disk (if they are correct) to the FRAM on the new I/O Controller card.</p>

→ Better games through innovation

TAB-Austria Industrie- und Unterhaltungselektronik GmbH & CoKG  
 Haider Strasse 40, A-4052 Ansfelden, UID-Nr.: ATU57977639  
 Tel. +43 (0)7229/78 040-0, Fax +43 (0)7229/78 660, e-mail: sales@tab.at, www.tab.at







## Maintenance Operating Elements

### Coin Acceptor

Comestero RM5HD

#### Acceptor maintenance

This fact sheet provides the necessary information for the clearing and maintenance of the RM5HD electronic coin validator.

Cleaning at regular intervals assures a high quality standard of coin recognition and, in the long run, reduces the risk of error and failure.

#### External cleaning

The external surfaces of the coin validator are made of a plastic shockproof material (ABS). To clean them it is recommended to use a soft cloth with a neutral detergent. For more resistant dirt ethyl alcohol can be used. To remove excess dust from the coin slots and other narrow spaces the use of compressed air or a paintbrush is recommended.



#### ATTENTION!

Do not use sharp or abrasive tools, which could damage the surface and the recognizing sensors.

Do not put the coin validator in water or any other type of liquid.

#### Internal cleaning

In the RM5HD electronic coin validator the coin recognizing sensors are installed behind a small spring door. Open the door to have access to this space as shown (fig.1).

Clean the excess dirt from behind the door with a grease removing spray, for example a normal detergent for windows and mirrors, removing more resistant dirt with a small brush.

Ethyl alcohol can be used. Do not touch or spray the sensors!

There are three small holes behind the door. These holes are where the coin recognizing sensors are put in place (fig.2). If dust or dirt blocks these holes the performance of the coin validator could be reduced and, in extreme cases, no coins would be recognized.

To keep the sensors clean whilst in position use compressed air only.



#### ATTENTION!

Do not use any type of sharp object, such as pins or screw drivers, to remove dust from the sensors as they could be irreparably damaged putting the coin validator out of use.

→ Better games through innovation

TAB-Austria Industrie- und Unterhaltungselektronik GmbH & CoKG  
Haider Strasse 40, A-4052 Ansfelden, UID-Nr.: ATU57977639  
Tel. +43 (0)7229/78 040-0, Fax +43 (0)7229/78 660, e-mail: sales@tab.at, www.tab.at



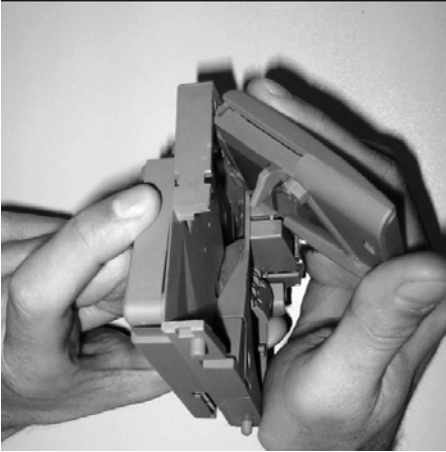

Fig.1

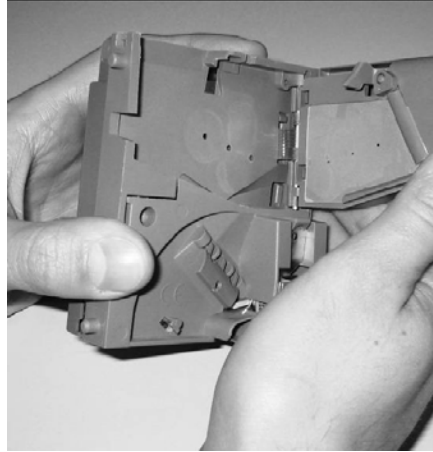

Fig.2

If the coin validator is still inefficient after cleaning do not hesitate to contact our hotline.

→ Better games through innovation

TAB-Austria Industrie- und Unterhaltungselektronik GmbH & CoKG  
Halder Strasse 40, A-4052 Ansfelden, UID-Nr.: ATU57977639  
Tel. +43 (0)7229/78 040-0, Fax +43 (0)7229/78 660, e-mail: sales@tab.at, www.tab.at





## NRI G-13 mft

### Acceptor maintenance

The coin validator must only be wiped clean from time to time with a damp cloth (lukewarm water with some detergent). Beyond that, no further maintenance work is required.

Under no circumstances may the cloth be so wet that fluid runs into the device. Otherwise the PCB will be damaged.

Do not use any solvents or scouring agents that will attack the plastic material of the device.

1. Pull the machine's mains plug
2. Carefully open the flight deck on the left-hand side and hold it open
3. Use a cloth to wipe off the coin runway inside the coin validator.
4. Close the flight deck again.
5. Reconnect the machine to the mains supply.

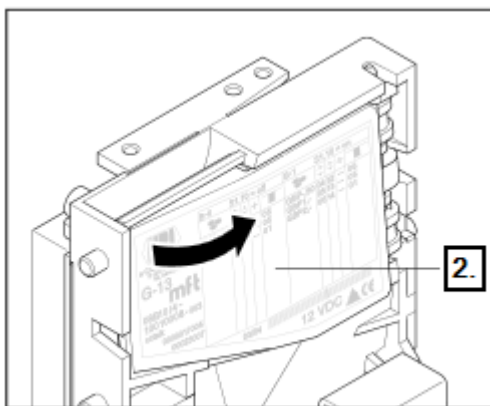

Open the flight deck of the coin validator.

→ Better games through innovation

TAB-Austria Industrie- und Unterhaltungselektronik GmbH & CoKG  
Haider Strasse 40, A-4052 Ansfelden, UID-Nr.: ATU57977639  
Tel. +43 (0)7229/78 040-0, Fax +43 (0)7229/78 660, e-mail: sales@tab.at, www.tab.at





## Bill Acceptor

### Astro GBA ST2

#### Periodical Cleaning

Depending on the environment and amount of use, the ST2 currency validator may require routine

- Maintenance to restore optimum performance
- Under normal use, the currency validator should be checked every **2 to 4 months**
- For unusual operating conditions, such as when the currency validator is exposed to a smoky environment, dirt, dust, water spray, airborne oil, and/or sand, more frequent maintenance is required.

#### Cleaning Process

1. Power down the currency validator and disconnect the external host loom.



→ Better games through innovation

TAB-Austria Industrie- und Unterhaltungselektronik GmbH & CoKG  
Halder Strasse 40, A-4052 Ansfelden, UID-Nr.: ATU57977639  
Tel. +43 (0)7229/78 040-0, Fax +43 (0)7229/78 660, e-mail: sales@tab.at, www.tab.at







2. To remove the GBA ST2 from the faceplate, gently push the two purple bezel retainer buttons inwards until they are in contact with the validator. With these depressed, pull on the validator to remove from its locking stage.



3. Move the two purple latches inwards to unlatch and then gently pivot top section backwards to open and remove.

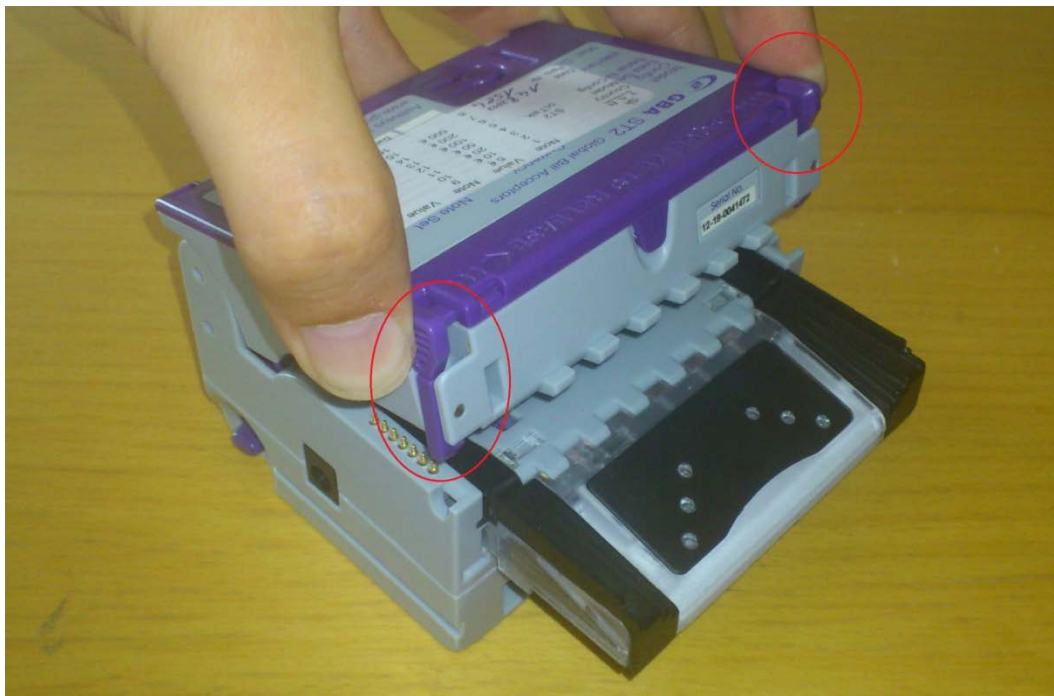

→ Better games through innovation

TAB-Austria Industrie- und Unterhaltungselektronik GmbH & CoKG  
Halder Strasse 40, A-4052 Ansfelden, UID-Nr.: ATU57977639  
Tel. +43 (0)7229/78 040-0, Fax +43 (0)7229/78 660, e-mail: sales@tab.at, www.tab.at







4. Please use a cotton swab or lint-free cloth and a cleaning solution -- a mix of water and up to 50 % Iso Propyl Alcohol (IPA) is recommended.
  - DO NOT use more than 50 % IPA. NEVER use solvent--based cleaning agents, such as pure alcohol, petrol, methylated spirit or white spirit on this product as the unit will be severely damaged.
  - Using the Cotton swab or cloth dipped in the cleaning solution - carefully clean all sensors and plastic windows using light force only.

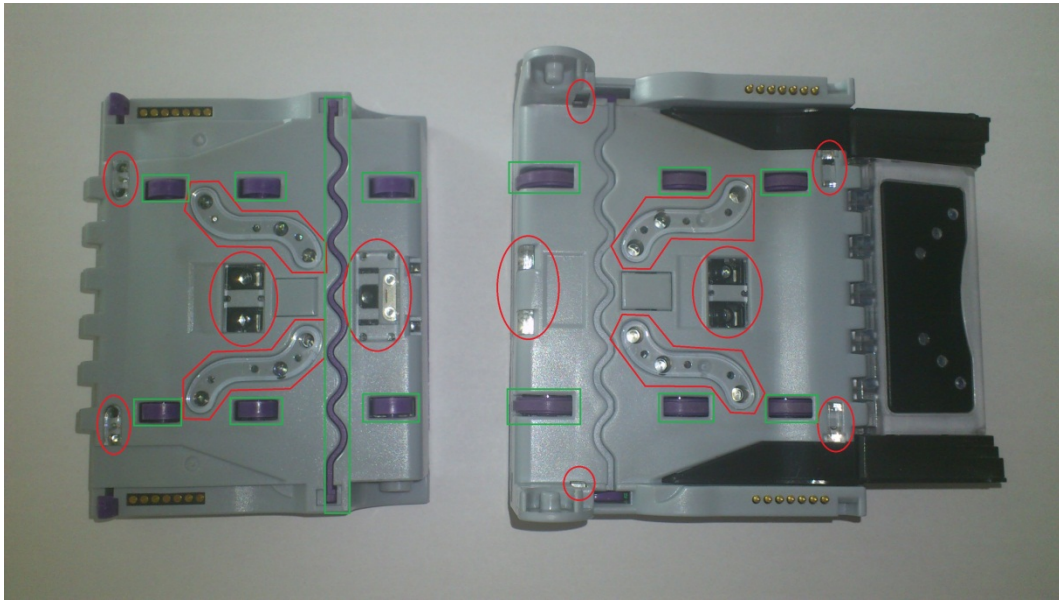

- Continue with swab to clean note path, all rollers and belts.
  - Use an additional swab or cloth to dry area cleaned, if required.
  - Reconnect host loom.
5. To refit the currency validator to the faceplate simply, insert the two black locating legs into the holes and push fully until you hear a loud clipping sound.
  6. Pull fully on the validator to ensure correct fitment.

→ Better games through innovation

TAB-Austria Industrie- und Unterhaltungselektronik GmbH & CoKG  
Halder Strasse 40, A-4052 Ansfelden, UID-Nr.: ATU57977639  
Tel. +43 (0)7229/78 040-0, Fax +43 (0)7229/78 660, e-mail: sales@tab.at, www.tab.at





## Calibration

Although calibration of the Astro ST2 is not necessary, it is recommended periodically for preventative maintenance, and also after any change to the software configuration of the unit.

To carry out this calibration you need two adjustment papers for the Astro ST2. (Order number: 28600035 - Calibration paper set Astro ST2).

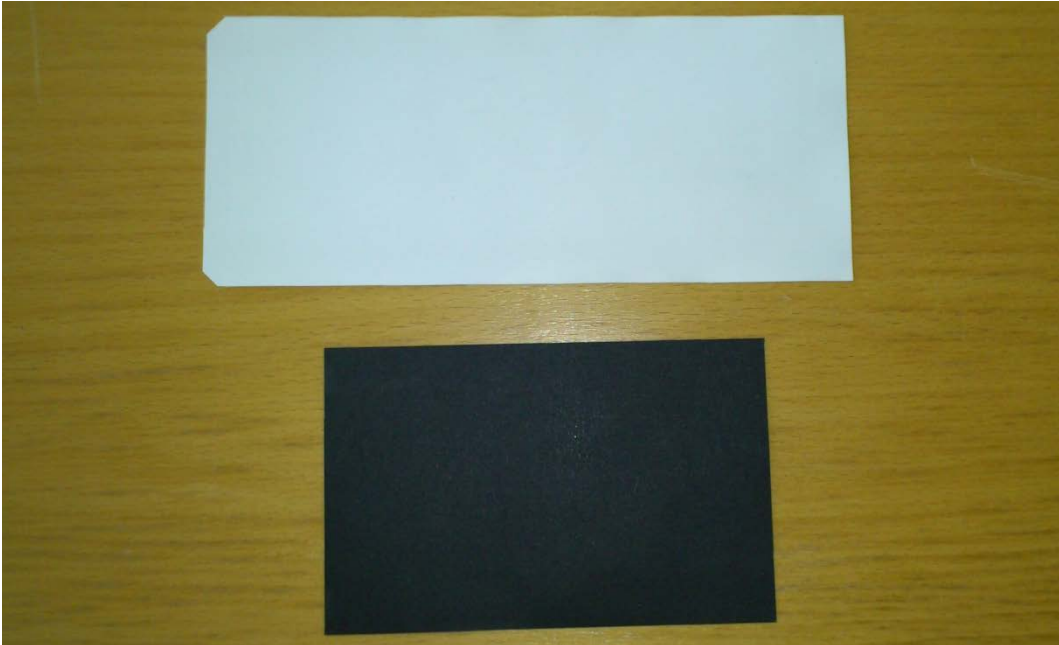

### Procedure:

1. Push button 3 times, the rear diagnostic LED will rapidly flash orange to show the unit is in calibration mode.



→ Better games through innovation

TAB-Austria Industrie- und Unterhaltungselektronik GmbH & CoKG  
Haider Strasse 40, A-4052 Ansfelden, UID-Nr.: ATU57977639  
Tel. +43 (0)7229/78 040-0, Fax +43 (0)7229/78 660, e-mail: [sales@tab.at](mailto:sales@tab.at), [www.tab.at](http://www.tab.at)





2. Insert the white calibration paper. It should be presented in the center of the note path and square to the direction of travel.

The currency validator will draw-in the paper all the way into the cassette; hold it momentarily before returning it in several short steps.

3. Remove the white calibration paper and insert the black calibration paper.

The unit will draw-in the paper and return it immediately in one smooth action.

4. Calibration is complete.

If calibration has not been successful, the diagnostic LED will repeatedly flash a four color error code until the push button is pressed to cancel.

→ Better games through innovation

TAB-Austria Industrie- und Unterhaltungselektronik GmbH & CoKG  
Haider Strasse 40, A-4052 Ansfelden, UID-Nr.: ATU57977639  
Tel. +43 (0)7229/78 040-0, Fax +43 (0)7229/78 660, e-mail: sales@tab.at, www.tab.at





## JCM Taiko PUB-7

### Periodical Cleaning

If the paper dust or foreign object spotted in the acceptor parts, the acceptance rate may go down. **Clean the acceptor parts once a month.**

- Wipe out on the sensor with lint-free cloth or cotton bud.
- Remove the paper dust or foreign object completely on the rollers.



### ATTENTION!

Do not use the organic solvent such as thinner or benzene, when wiping the TAIKO unit.

### Sensors/Rollers Location

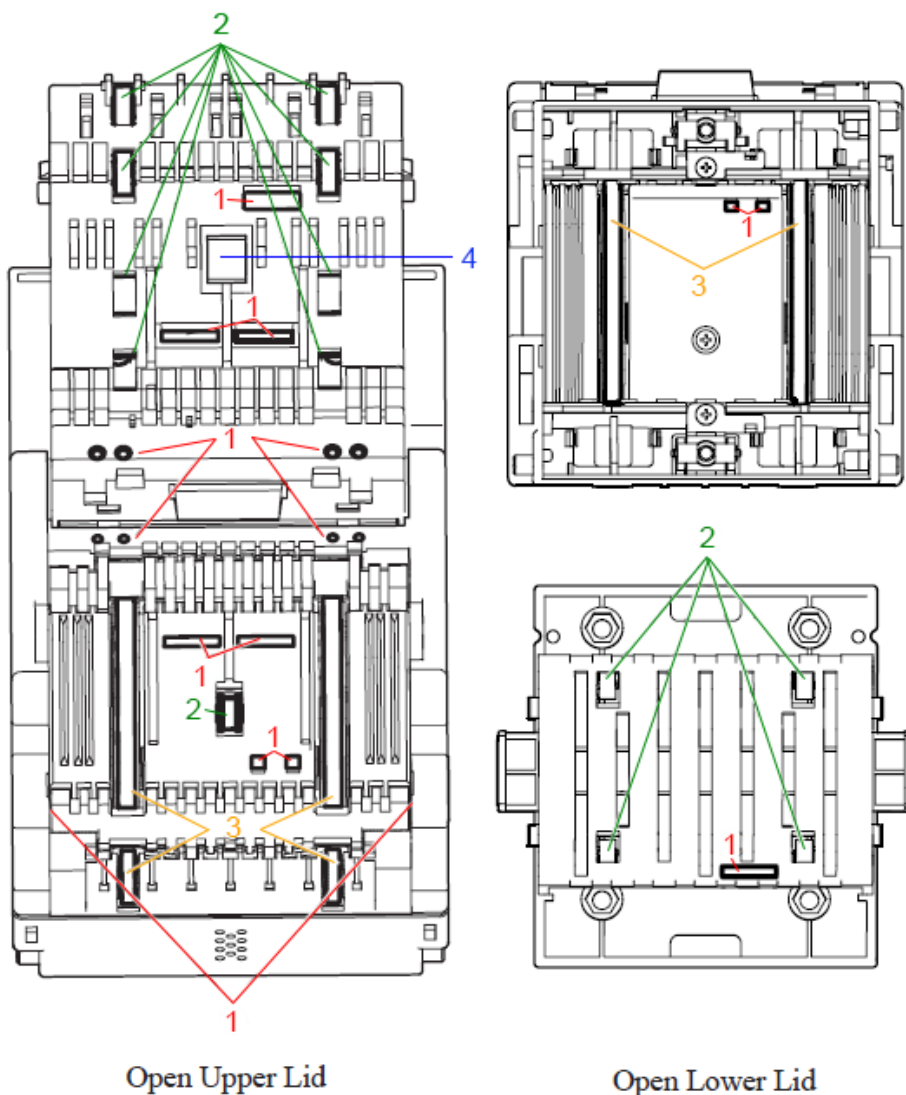

- 1...Sensor
- 2...Pinch Roller
- 3...Feed Roller
- 4...Magnetic Sensor (only PUB-11)

→ Better games through innovation

TAB-Austria Industrie- und Unterhaltungselektronik GmbH & CoKG  
 Haider Strasse 40, A-4052 Ansfelden, UID-Nr.: ATU57977639  
 Tel. +43 (0)7229/78 040-0, Fax +43 (0)7229/78 660, e-mail: sales@tab.at, www.tab.at

www.tab.at

# Wiring Diagram Main Harness

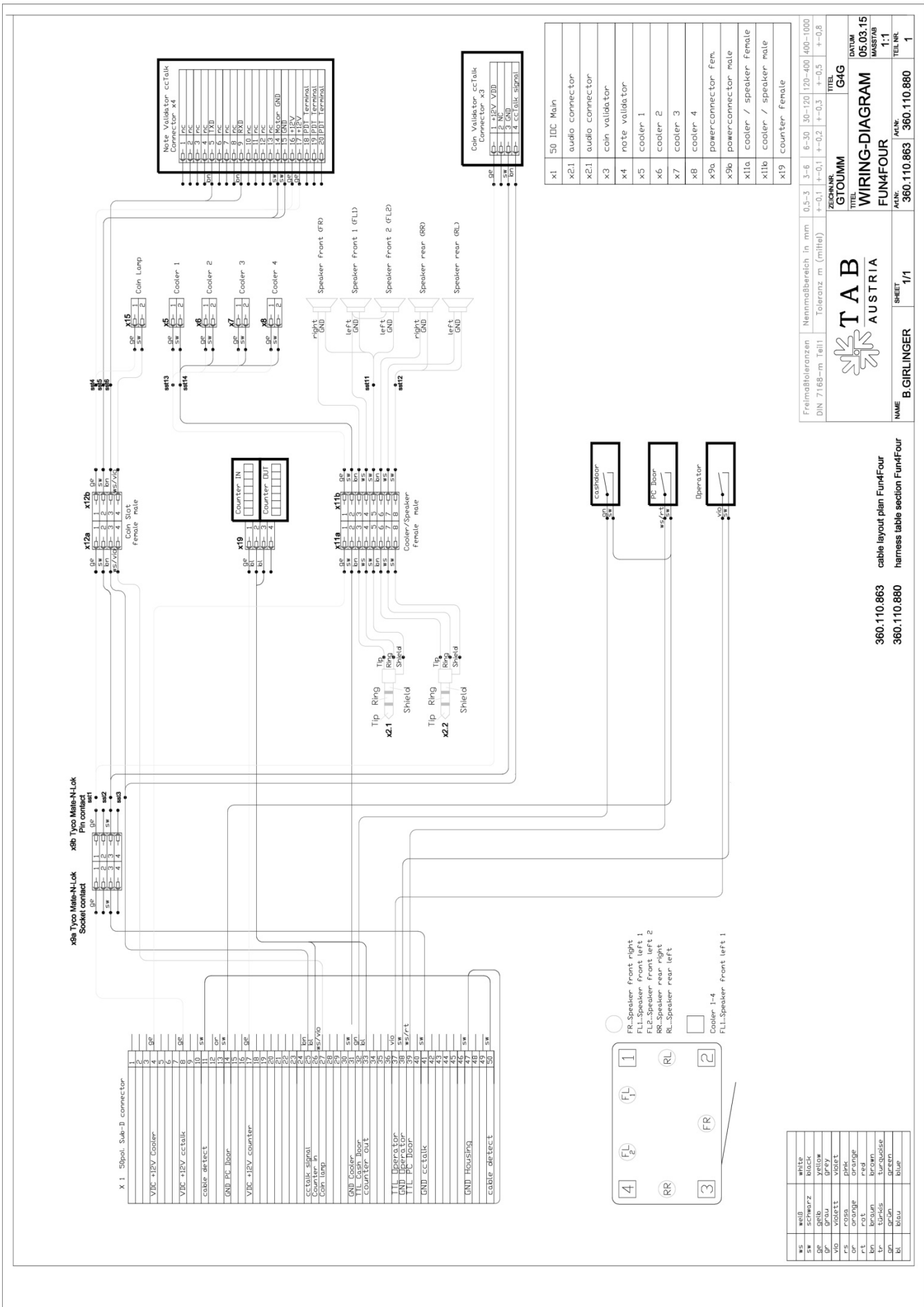

Freimaßtoleranzen	Nennmaßbereich in mm	0,5-3	3-6	6-30	30-120	120-400	400-1000
DIN 7168-m Teil1	Toleranz m (mittel)	+0,1	+0,1	+0,2	+0,3	+0,5	+0,8
ZEICHNUNG		GTOUMM		TITEL		G4G	
T A B		WIRING-DIAGRAM		DATUM		05.03.15	
AUSTRIA		FUN4FOUR		MASS/TAB		1:1	
NAME	B. GIRLINGER	SHEET	1/1	AKT.NR.	360.110.863	360.110.880	TEIL.NR.
							1

360.110.863 cable layout plan Fun4Four  
 360.110.880 harness layout section Fun4Four

## Block Diagram Power Cables

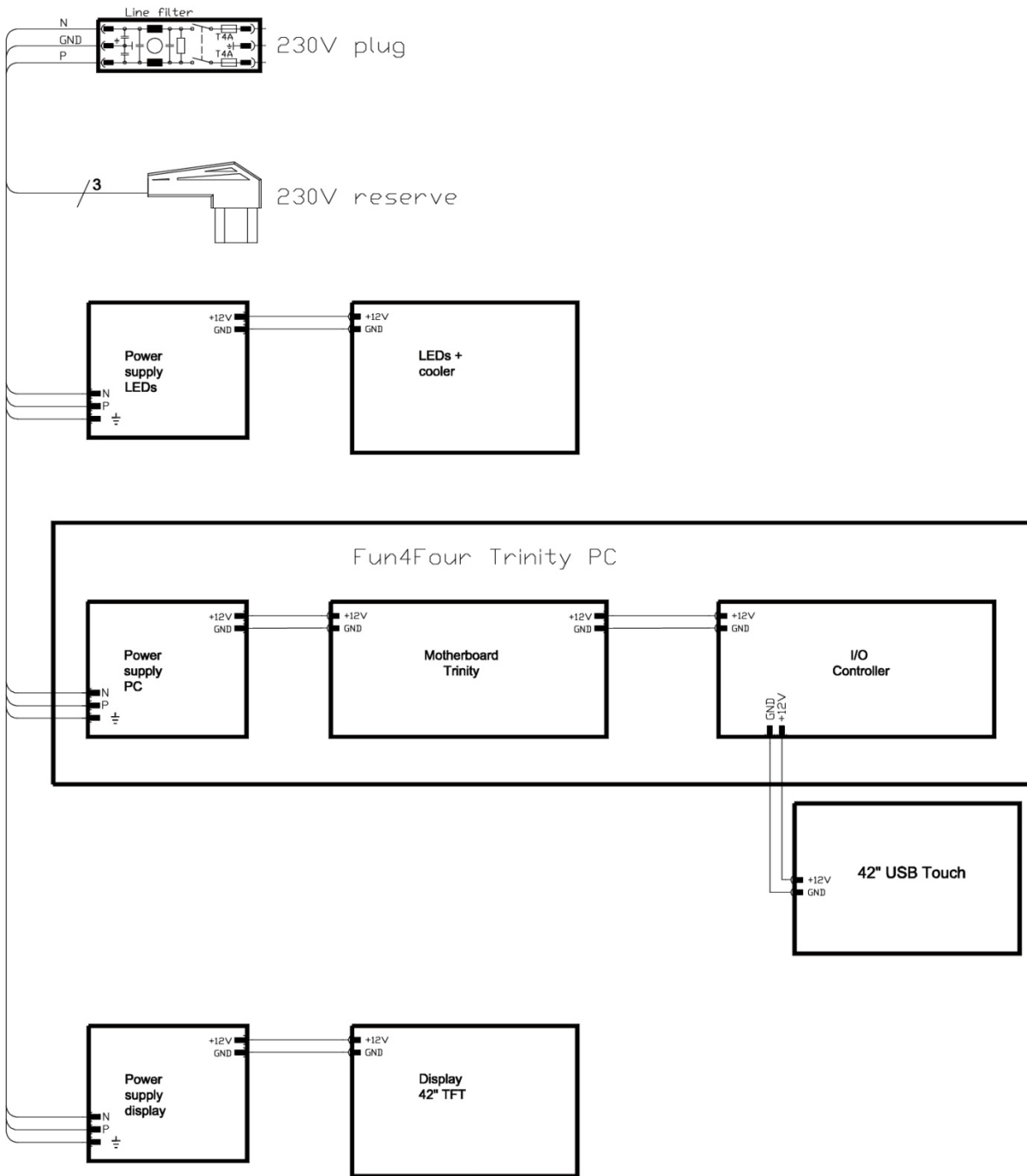



## Exploded Assembly Drawings

### Exploded Drawing FUN4FOUR

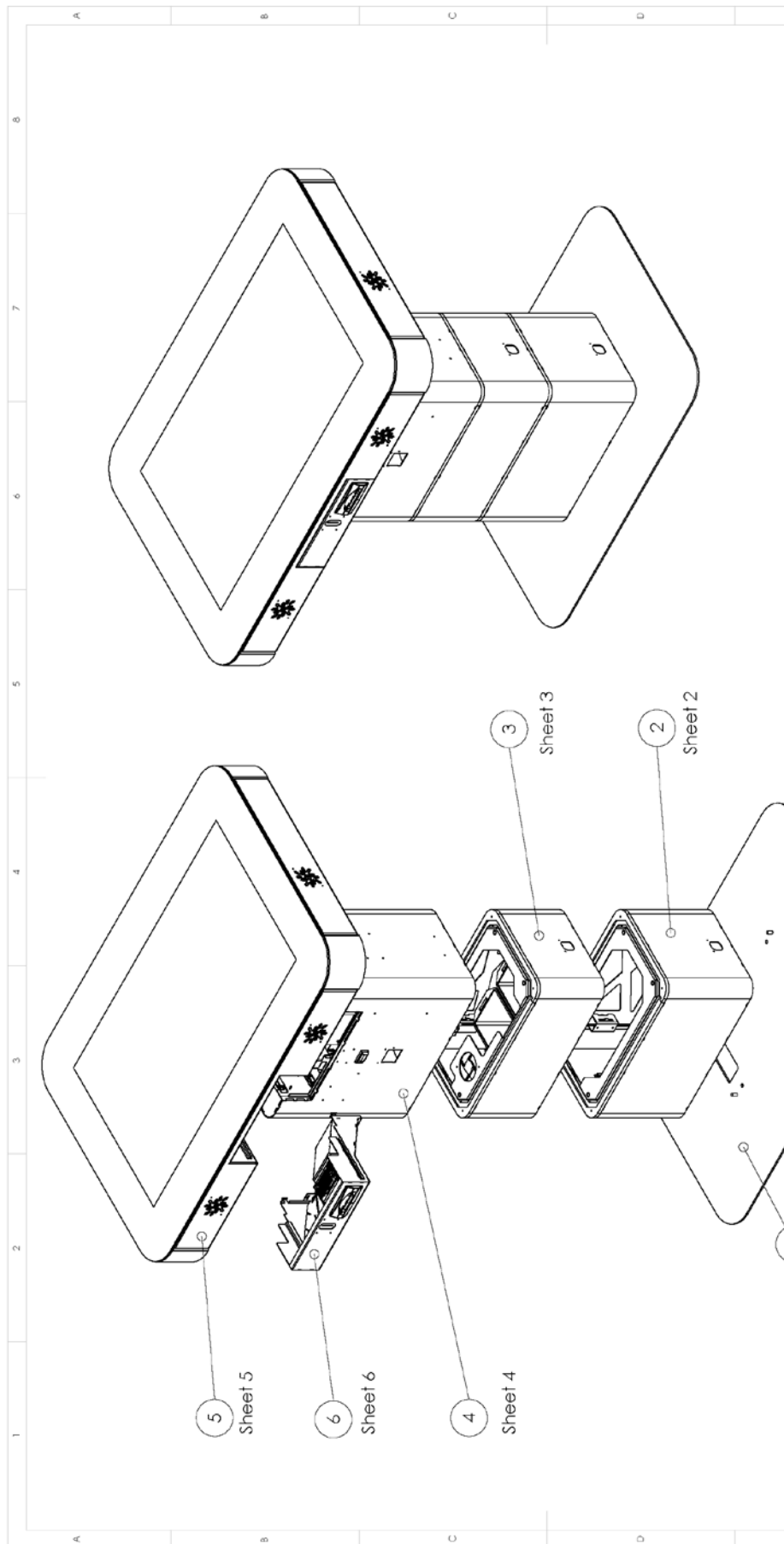

C	B	A	Index	Benennung	Datum	Name
					7322	Fun4Four
<b>TAB-Austria Holding GmbH</b>						
Fun4Four - Exploded Assembly Drawing						
Zzeichnung: 7322 Fun4Four						
Blatt 1 von 6						
<b>INDEX</b>						
ALL DIMENSIONS ARE IN MILLIMETERS						
SURFACE FINISH: RAZZ						
EDGES: RAZZ						
MATERIAL: ALUMINUM						
DATE: 20.03.12						
DRAWN BY: Frontberger						
DIN ISO 2768-1 m						
MASS: 7322 Fun4Four						
Diese Zeichnung ist Eigentum der TAB-Austria Holding GmbH. Unbefugte Verwendung durch Dritte wird gemäss den gesetzlichen Bestimmungen straf- und zivilrechtlich verfolgt!						

Pos	Name	Part Nr.	Quantity
1	Baseplate Fun4Four	022.130-466	1
1	Baseplate Fun4Four white	022.130-466-WS	1
2	Assembly Base Section Fun4Four	7322	1
3	Assembly Cash Box Section Fun4Four	7322	1
4	Assembly PC Section Fun4Four	7322	1
5	Assembly Display Section Fun4Four	7322	1
6	Assembly Deposit Section Fun4Four	7322	1
			3

Without Cable Harness !



# Assembly Cash Box Section

Sparepart with bonded LED-Stripes is available under number: 410.206-409 Cable LED stripes Fun4Four sated

Sparepart with bonded LED-Stripes is available under number: 410.206-403 Cable LED stripes Fun4Four

Without Cable Harness !

Pos	Name	Part Nr.	Quantity
1	Cash section Fun4Four pre-assembled	022.130-583	1
1	Cash section Fun4Four pre-assembled w/	022.130-583-ws	1
2	Lock 25mm 7pin Octagon-28D251CPD	675.191-944	1
3	Locking Plate Fun4Four	022.130-591	1
4	Cover for cable track WF 2	022.032-003	2
4	Cover for cable track WF 2 white	022.032-003-ws	2
5	light ring Fun4Four	373.115-206	1
6	Fan 80x80mm with JST Connector	831.900-033	1
7	Connection harness 1 counter 6-digits	362.000-081	1
8	Rear Switch Flat Plug Push/Pull 3p	671.188-150	1
9	Plastic Cashbox SB Pro	361.110-125	2
10	light ring Fun4Four acryl sated	373.115-215	1

INDEX		INDEX x Benennung		DATE AND BREAK STRAP EDGES		DATE		DATE	
SURFACE FINISH: POLISHED ANGLE		OBERFLÄCHE: POLIERUNG ANGLE		DATE		DATE		DATE	
DIMENSIONS: 2003.12		DATE		DATE		DATE		DATE	
DIN SO 2768-1 m		DATE		DATE		DATE		DATE	
MATERIAL: 7322		DATE		DATE		DATE		DATE	
MATERIAL: 7322 Fun4Four		DATE		DATE		DATE		DATE	
MATERIAL: 7322 Fun4Four		DATE		DATE		DATE		DATE	
MATERIAL: 7322 Fun4Four		DATE		DATE		DATE		DATE	

Diese Zeichnung ist Eigentum der TAB-Austria Holding GmbH. Unbefugte Verwendung durch Dritte wird i.d.R. nicht zulässig. Bei der Weitergabe dieser Zeichnung sind die gesetzlichen Bestimmungen strikt zu beachten.

# Assembly PC Section Drawing

Pos	Name	Part Nr.	Quantity
1	PC section Fun4Four pre-assembled white	022.130-584-ws	1
2	coin crest Fun4Four	361.070-573	1
3	coin funnel 4mm Fun4Four	361.138-323	1
4	note slide Fun4Four	022.130-473	1
5	mounting plate line in filter Fun4Four	022.130-480	1
6	Mounting plate power supply Fun4Four	022.130-596	1
7	slide plate looking PC door Fun4Four	022.130-599	1
8	Lock 25mm 7pin Octagon-28D251CPD yellow	675.191-944	1
9	Locking plate PC Fun4Four	022.130-598	1
10	Locking Bar PC Door Fun4Four	022.130-580	1
11	Hinge locking bar PC door Fun4Four	022.130-593	1
12	Plexi insert Fun4Four	672.220-452	1
13	Hinge bottom MAX FIRE	675.191-166	1
14	Clamp lock for cover SILVERBALL II	022.196-131	2
15	Fan 80x80mm with .5T Connector	831.900-033	1
16	Linefilter 4A 2x3.15AT	671.115-509	1
17	Wall Power Supply 10-51050400A 12VDC	831.600-035	1
18	Rear Switch Flat Plug Push/Pull 3p	671.188-150	1
19	PC TAB Micro-ATX 2 Fun4Four	831.500-008	1
20	Knurled thumb screw M4x16 DIN 464	680.130-102	2
21	Front Plate Mini for Secco RM-FI	464-065-245	1
22	Coin Acceptor RL587C24/A1000T	464.138-446	1
23	PC TAB mitX Trinity Fun4Four	831.500-031	1
24	PC section Fun4Four pre-assembled	022.130-584	1
25	WiLan Router Wireless N	831.800-073	1

Without Cable Harness !

Index	Index x	Benennung	Datum	Name
C	B	A	7322	Fun4Four
UNLESS OTHERWISE SPECIFIED: DIMENSIONS ARE IN MILLIMETERS TOLERANCES: LINEAR: ANGULAR:			DESK AND BLACK SHELF CASE	
Geometrische Formtoleranzen			Maße ohne Toleranzen DIN ISO 2768-1 m	
NAME: Promberger			DATE: 20.03.12	
MATERIAL:			Zzeichnung:	
Diese Zeichnung ist Eigentum der TAB-Austria Holding GmbH. Unbefugte Verwendung, Kopieren, Nachbearbeitung, Verbreitung ist ohne schriftliche Genehmigung TAB-Austria Holding GmbH. Nachdruck ist ohne schriftliche Genehmigung TAB-Austria Holding GmbH. Nachdruck ist ohne schriftliche Genehmigung TAB-Austria Holding GmbH.			7322 Fun4Four	
			A3	
			Blatt 4 von 4	

# Assembly Table Section Drawing

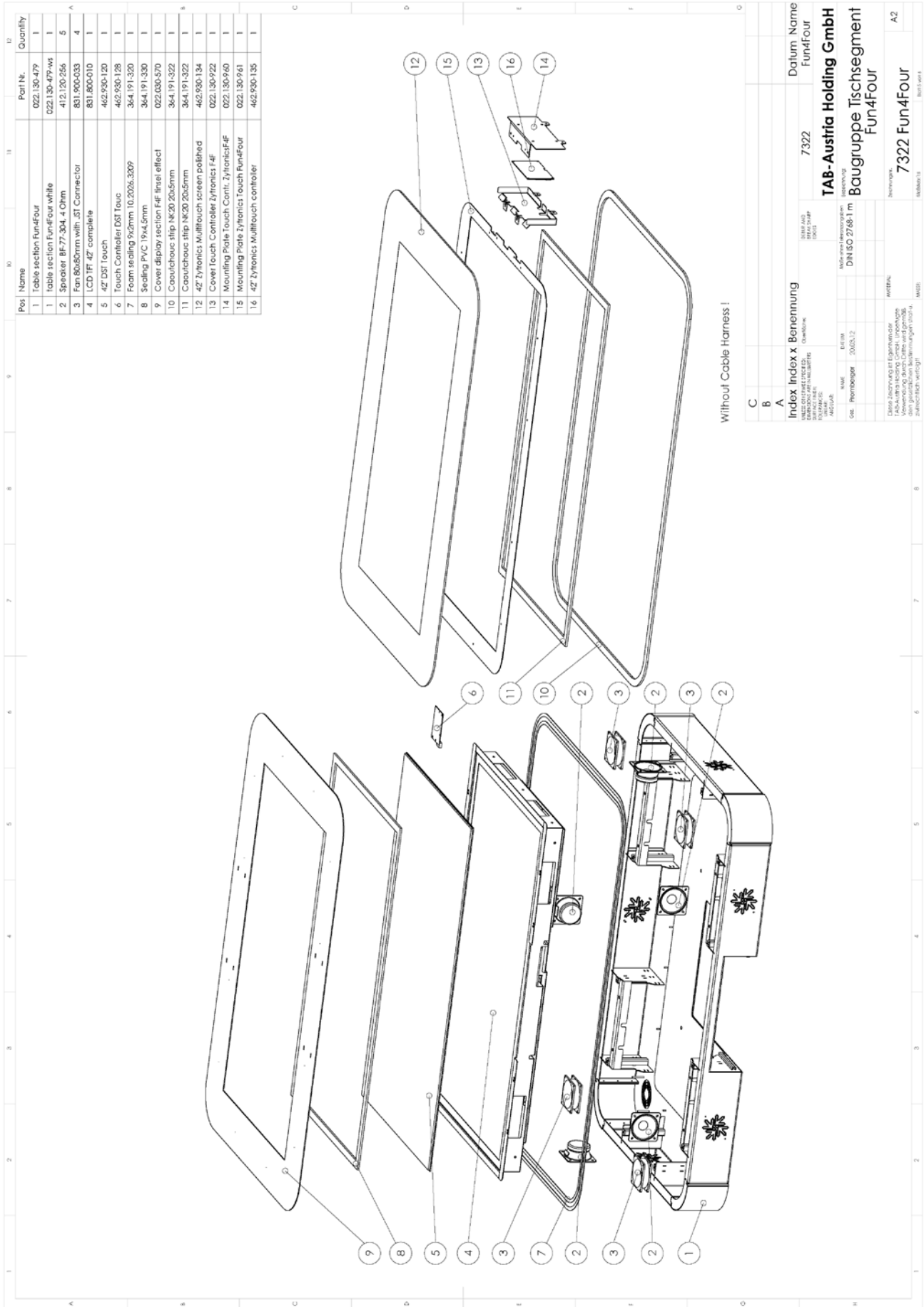

Pos	Name	Part No.	Quantity
1	Table section Fun4Four	022.130-479	1
1	Table section Fun4Four white	022.130-479-ws	1
2	Speaker BF-77-304, 4 Ohm	412.120-256	5
3	Fan 80x80mm with .JST Connector	831.900-033	4
4	LCD 17" 42" complete	831.800-010	1
5	42" DST Touch	462.930-120	1
6	Touch Controller DST Touc	462.930-128	1
7	Foam sealing 9x2mm 10.2026.3209	364.191-320	1
8	Sealing PVC 19x4.5mm	364.191-330	1
9	Cover display section F4F lens effect	022.030-570	1
10	Cautouchou strip NK20 20x5mm	364.191-322	1
11	Cautouchou strip NK20 20x5mm	364.191-322	1
12	42" Zytronics Multitouch screen polished	462.930-134	1
13	Cover Touch Controller Zytronics F4F	022.130-922	1
14	Mounting Plate Touch Contr. Zytronics F4F	022.130-960	1
15	Mounting Plate Zytronics Touch Fun4Four	022.130-961	1
16	42" Zytronics Multitouch controller	462.930-135	1

Index		Index x Benennung		Datum		Name	
C	B	A					
WELT DER ZUSATZLICHER SPEZIFIKATIONEN FÜR EINBAU- UND EINBAU- UND		CHANGES		7322		Fun4Four	
ZUSÄTZLICHE SPEZIFIKATIONEN FÜR EINBAU- UND EINBAU- UND		DIN ISO 2768-1 m		TAB-Austria Holding GmbH		Baugruppe Tischsegment Fun4Four	
Cat. Probenlager		2005/12		7322 Fun4Four		A2	
Datei Zeichnung ist Eigentum der TAB-Austria Holding GmbH und kann ohne schriftliche Genehmigung der TAB-Austria Holding GmbH nicht verbreitet werden.		MATERIAL		REVISIONEN		MATERIAL	

# Assembly Deposit Section Drawing

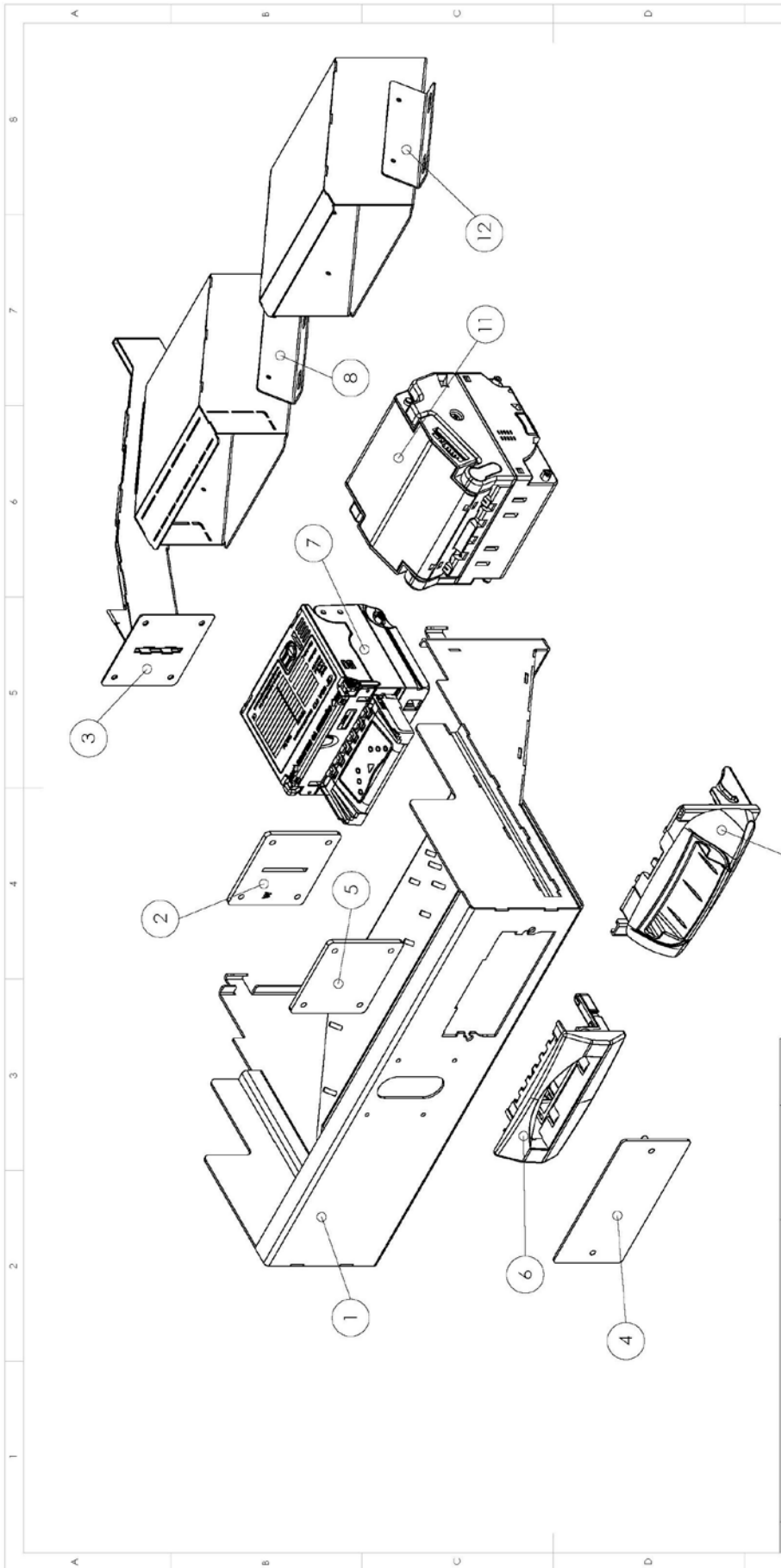

Pos	Name	Part Nr.	Quantity
1	Deposit Section ST2/PUB7 Fun4Four	022.130-521	1
2	Deposit Section Bet F4F white	022.130-574-ws	1
3	plexi: coin slot 3,5x35 Fun4Four	672.220-456	1
4	coin channel 4mm Fun4Four	361.138-324	1
5	Cover note reader ST2 Fun4Four	022.080-303	1
6	Plexicover Coin slot Fun4Four	672.220-457	1
7	Bezel Standard (Smiley) Astro ST2	022.130-526	1
8	Bill Acceptor Astro GBA ST2-S25	010.100-582	1
9	Note Channel ASTRO ST2 Fun4Four	022.130-576	1
10	Face Plate EUR Taiko PUB-7	022.031-069	1
11	Bill Acceptor Taiko PUB-7	010.100-594	1
12	Note Channel PUB7 Fun4Four	022.131-303	1

Without Cable Harness !

C	B	A	Index	x	Benennung	Datum	Name
						7322	Fun4Four
<small>UNLESS OTHERWISE SPECIFIED: DIMENSIONS ARE IN MILLIMETERS TOLERANCES: LINEAR: ANGULAR:</small>						<b>TAB-Austria Holding GmbH</b> <small>Zeichnung:</small>	
<small>DESK AND BACKSTAFF BASE:</small>						<small>Meße ohne Toleranzen DIN ISO 2768-1 m</small>	
<small>NAME: Promberger</small>						<small>DATE: 20.03.12</small>	
<small>Gen: 7322</small>						<small>MATERIAL:</small>	
<small>Diese Zeichnung ist Eigentum der TAB-Austria Holding GmbH. Unbefugte Verwendung ist nicht zulässig. Alle Rechte vorbehalten. Nachahmungen strafrechtlich verfolgt.</small>						<small>Zeichnung:</small> <b>7322 Fun4Four</b> <small>Seite von 4</small>	



## EC Declaration of Conformity



### Declaration of CE conformity

Document-no.: QZ/1000/073/01/170908  
Producer: TAB AUSTRIA  
Industrie- und Unterhaltungselektronik GmbH & Co KG  
Address: Haiderstraße 40  
A-4052 Ansfelden  
Tel.no.: 07229/78040, Fax-no.: 07229/78040-99

Description of good: Amusement machine  
Type: FUN4 FOUR

This mentioned product corresponds to the following European Regulations:

Criterion: 73/23/EWG  
Criterion of the council for the adaptation of the legal regulations of the member states, concerning electrical working founds for using within limited tension bounds, changed by RL 93/68/EWG.

Criterion: 89/336/EWG  
Criterion of the council for the adaptation of the legal regulations of the member states, concerning the electromagnetic compatibility changed by RL 91/263/EWG, 92/31/EWG, 93/68/EWG and 93/97/EWG.

The conformity of the mentioned product with the regulations of the criterions is shown through the observance of the relevant sections of the following norms:

Matched European norms:	Document	Issuing date
	EN 55022	1998
	EN 55024	1998
	EN 60950	2000
	EN 61000-3-2	2000
	EN 61000-3-3	2000

Issued by: GF  
Managing Director: Ing. Siegfried Dattl jun.  
Place, date: Ansfelden, September 17<sup>th</sup> 2008

Legally binding signature:



The declaration certifies the conformity with the mentioned criterions, but it doesn't include the assurance of characteristics. The safety regulations of the delivered goods have to be read through carefully.



## End user license agreement for MICROSOFT software

### **IMPORTANT - READ CAREFULLY:**

This End-User License Agreement ("EULA") is a legal agreement between you (either an individual or a single entity) and the manufacturer ("Manufacturer") or the special purpose computing device ("SYSTEM") you acquired which includes certain Microsoft software product(s) installed on the SYSTEM ("SOFTWARE PRODUCT" or "SOFTWARE"). The SOFTWARE includes computer software, the associated media, any printed materials, and any "online" or electronic documentation. By installing, copying or otherwise using the SOFTWARE, you agree to be bound by the terms of this EULA. If you do not agree to the terms of this EULA, Manufacturer and Microsoft Corporation ("Microsoft") are unwilling to license the SOFTWARE to you. In such event, you may not use or copy the SOFTWARE, and you should promptly contact Manufacturer for instructions on return of the unused product(s) for a refund.

### **SOFTWARE LICENSE**

The SOFTWARE is protected by copyright laws and international copyright treaties, as well as other intellectual property laws and treaties. The SOFTWARE is licensed, not sold.

**1. GRANT OF LICENSE:** This EULA grants you the following rights:

- **Software:**

You may use the SOFTWARE as installed on the System.

- **Application Sharing:**

The SOFTWARE may contain technology that enables applications to be shared between two or more SYSTEMS, even if an application is installed on only one of the SYSTEMS. You should consult your application license agreement or contact the application licensor to determine whether sharing the application is permitted by its licensor.

- **Storage/Network Use:**

If the SOFTWARE PRODUCT is installed on the SYSTEM over an internal network from a server, you must acquire and dedicate a license for the SOFTWARE PRODUCT for each SYSTEM on which the SOFTWARE PRODUCT is used or to which it is distributed. A license for the SOFTWARE PRODUCT may not be shared or used concurrently on different SYSTEMS.

- **Back-up Copy:**

If MANUFACTURER has not included a copy of the SOFTWARE on separate media with the SYSTEM, you may make a single copy of the SOFTWARE for use solely for archival purposes with the SYSTEM.

→ Better games through innovation

TAB-Austria Industrie- und Unterhaltungselektronik GmbH & CoKG  
Haider Strasse 40, A-4052 Ansfelden, UID-Nr.: ATU57977639  
Tel. +43 (0)7229/78 040-0, Fax +43 (0)7229/78 660, e-mail: [sales@tab.at](mailto:sales@tab.at), [www.tab.at](http://www.tab.at)





## 2. DESCRIPTION OF OTHER RIGHTS AND LIMITATIONS

- **Limitation on Reverse Engineering, De-compilation and Disassembly:**  
You may not reverse engineer, decompile, or disassemble the SOFTWARE, except and only to the extent that such activity is expressly permitted by applicable law notwithstanding this limitation.
- **Single SYSTEM:**  
The SOFTWARE is licensed with the SYSTEM as a single integrated product. The SOFTWARE may only be used with the SYSTEM.
- **Rental:**  
You may not rent or lease the SOFTWARE.
- **Software Transfer:**  
You may permanently transfer all of your rights under this EULA only as part of a sale or transfer of the SYSTEM, provided you retain no copies, you transfer all of the SOFTWARE (including all component parts, the media, any upgrades or backup copies, and this EULA, and if applicable, the Certificate(s) of Authenticity), and the recipient agrees to the terms of this EULA. If the SOFTWARE is an upgrade, any transfer must include all prior versions of the SOFTWARE.
- **Termination:**  
Without prejudice to any other rights, Manufacturer or Microsoft may terminate this EULA if you fail to comply with the terms and conditions of this EULA. In such event, you must destroy all copies of the SOFTWARE and all of its component parts.
- **Single EULA:**  
The package for the SOFTWARE may contain multiple versions of this EULA, such as multiple translations and/or multiple media versions (e.g., in the user documentation and in the software). In this case, you are only licensed to use one (1) copy of the SOFTWARE PRODUCT.

## 3. UPGRADES AND RECOVERY MEDIA

- If the SOFTWARE is provided by Manufacturer on media separate from the SYSTEM and is labeled "For Upgrade Purposes Only" (Upgrade SOFTWARE), you may install one copy of the Upgrade SOFTWARE onto the SYSTEM as a replacement copy for the SOFTWARE originally installed on the SYSTEM and use it in accordance with Section 1 of this EULA. You may also install additional copies of the Upgrade SOFTWARE as replacement copies onto additional SYSTEMS which are the same brand and model as the SYSTEM and contain a duly licensed copy of the same version and language release of the SOFTWARE ("ADDITIONAL SYSTEMS"), provided that (1) Manufacturer has supplied a corresponding serialized sticker for each additional copy of the Upgrade SOFTWARE, and (2) you affix a serialized sticker per Manufacturer's instructions for each unit of Upgrade SOFTWARE you install.

→ Better games through innovation

TAB-Austria Industrie- und Unterhaltungselektronik GmbH & CoKG  
Haider Strasse 40, A-4052 Ansfelden, UID-Nr.: ATU57977639  
Tel. +43 (0)7229/78 040-0, Fax +43 (0)7229/78 660, e-mail: [sales@tab.at](mailto:sales@tab.at), [www.tab.at](http://www.tab.at)





- If the SOFTWARE is provided by Manufacturer on separate media and labeled as "Recovery Media", you may not make a copy of the SOFTWARE as described in Section 1 for archival purposes. Instead, you may use the Recovery Media solely to restore or reinstall the same version and language release of the SOFTWARE as originally installed on the SYSTEM and thereafter use the SOFTWARE as restored or reinstalled in accordance with Section 1 of this EULA. A single unit of Recovery Media may be used by you to restore or reinstall the SOFTWARE on ADDITIONAL SYSTEMS.

#### 4. COPYRIGHT

- All title and copyrights in and to the SOFTWARE (including but not limited to any images, photographs, animations, video, audio, music, text and "applets," incorporated into the SOFTWARE), the accompanying printed materials, and any copies of the SOFTWARE, are owned by Microsoft or its suppliers. You may not copy the printed materials accompanying the SOFTWARE. All rights not specifically granted under this EULA are reserved by Microsoft.

#### 5. PRODUCT SUPPORT

- Product support for the SOFTWARE is not provided by Microsoft or its subsidiaries. For product support, please refer to Manufacturer's support number provided in the documentation for the SYSTEM. Should you have any questions concerning this EULA, or if you desire to contact Manufacturer for any other reason, please refer to the address provided in the documentation for the SYSTEM.

#### 6. LIMITED WARRANTY

- **Limited Warranty:** Manufacturer warrants that the SOFTWARE will perform substantially in accordance with the accompanying written materials for a period of ninety (90) days from the date of receipt. Any implied warranties on the SOFTWARE are limited to ninety (90) days. Some states/jurisdictions do not allow limitations on duration of an implied warranty, so the above limitation may not apply to you.
- **Customer Remedies:** Manufacturer's and its suppliers' entire liability and your exclusive remedy shall be, at Manufacturer's option, either (a) return of the price paid, or (b) repair or replacement of the SOFTWARE that does not meet the above Limited Warranty and which is returned to Manufacturer with a copy of your receipt. This Limited Warranty is void if failure of the SOFTWARE has resulted from accident, abuse, or misapplication. Any replacement SOFTWARE will be warranted for the remainder of the original warranty period or thirty (30) days, whichever is longer.

→ Better games through innovation

TAB-Austria Industrie- und Unterhaltungselektronik GmbH & CoKG  
Haider Strasse 40, A-4052 Ansfelden, UID-Nr.: ATU57977639  
Tel. +43 (0)7229/78 040-0, Fax +43 (0)7229/78 660, e-mail: [sales@tab.at](mailto:sales@tab.at), [www.tab.at](http://www.tab.at)





- **No Other Warranties:**

Except as expressly provided in the limited warranty section above, the SOFTWARE is provided to the end user "as is" without of any kind, either expressed or implied, including, but not limited to, warranties of non-infringement, merchantability, and/or fitness for a particular purpose. The entire risk of the quality and performance of the SOFTWARE is with you.

- **No Liability for Consequential Damages:**

Manufacturer's suppliers shall not be held to any liability for any damages suffered or incurred by the end user (including, but not limited to, general, special, consequential or incidental damages including damages for loss of business profits interruption, loss of business information and the like), arising from or in connection with the delivery, use or performance of the SOFTWARE.

## 7. Note on JAVA Support.

The SOFTWARE product may contain support for programs written in JAVA. JAVA TECHNOLOGY is not fault tolerant and is not designed, manufactured, or intended for use or resale as ON-LINE CONTROL EQUIPMENT in hazardous environments requiring fail-safe performance, such as in the operation of nuclear facilities, aircraft navigation or communication systems, air traffic control, direct life support machines, or weapons systems, in which the failure of JAVA TECHNOLOGY could lead directly to death, personal injury, or severe physical or environmental damage.

→ Better games through innovation

TAB-Austria Industrie- und Unterhaltungselektronik GmbH & CoKG  
Haider Strasse 40, A-4052 Ansfelden, UID-Nr.: ATU57977639  
Tel. +43 (0)7229/78 040-0, Fax +43 (0)7229/78 660, e-mail: [sales@tab.at](mailto:sales@tab.at), [www.tab.at](http://www.tab.at)



Version dated 12 November 2014

## **Warranty Terms**

by TAB-AUSTRIA Industrie und Unterhaltungselektronik GmbH & Co KG  
(TAB hereinafter)

We are granting a warranty for this machine under the following conditions:

1. Insofar as the "General Terms of Business of TAB-AUSTRIA Industrie- und Unterhaltungselektronik GmbH & Co KG" are not modified by the following, which sets out the conditions and scope of our warranty performance, these terms will continue to apply without change.
2. The warranty period for our products from delivery is:
  - **24 months** for (when purchased and operated in Austria)
    - Max Fire HD
    - Golden Island
    - Fun4Four
  - **12 months** for
    - all other products, particularly betting terminals
    - all products (including the above) purchased in Austria and operated outside Austria
  - **6 months** for
    - all spare parts
    - however, if a warranty period of more than six months still obtains for the machines, this period will apply in its entirety to the spare part.
3. The warranty will only be granted for new products by TAB, not for their spare parts, not for products of different brands and manufacturers and corresponding spare parts. No warranty is granted for used products either.
4. In accordance with the following provisions, we shall repair defects to the machine that have been demonstrably caused by a material and/or manufacturing fault which already existed at the time the product was handed over, and which was reported within 14 days of it becoming apparent to our sales partner or the first end user while still within the warranty period. No warranty is assumed for used machines.
5. The warranty exclusively covers such components that are essential to operating the product. It does not include easily damaged parts or wearing parts, such as, for example, glass, plastic or light bulbs. Minor deviations from the desired composition insignificant to the value and usability of the machine will not result in any warranty obligations. Damage caused by physical, chemical, electrical or electrochemical or other effects not related to the customary dedicated use will not result in any warranty obligations; neither





does damage caused by water or abnormal environmental conditions or inappropriate operating conditions. Also, no warranty can be assumed for machine defects caused by transport damage for which we are not responsible, incorrect installation and assembly, incorrect use, non-observance of operating or assembly instructions or lack of care.

6. The warranty claim becomes void if repairs or interventions have been carried out by the customer himself/herself or by persons who were not accordingly authorized or who were not authorized by us or in the event of our machines being fitted with spare, supplementary or accessory parts that are not original parts, or if parts have been removed.
7. The warranty performance will be made in such a way that defective components will at our discretion be repaired or replaced with faultless components free of charge unless improvement or exchange are impossible or would result in for us unreasonable cost. In such cases, a reduction in price or, in the event of not only a minor defect, cancellation of sale may be claimed.
8. Machines for which a warranty performance is being claimed on the basis of this warranty must be handed over or sent to us. Repairs at the installation site are not possible. The customer will bear transport costs and the transport risk.
9. Exchanged parts will become our property.
10. Warranty performances will neither result in an extension of the warranty period nor will they initiate a new warranty period.
11. Further or other claims (in particular claims for damages suffered beyond the machine) are excluded insofar as liability is not mandatory by law.
12. These warranty terms apply to machines operated outside of Austria only insofar as they possess the technical requirements (e.g. voltage, frequency, etc.) for the corresponding country, have been officially approved for use there and are suited to the individual climate and environmental conditions.
13. The TFT LCD display consists of more than 1,000,000 Thin-Film Transistors (TFT). A small amount of missing, black, or luminous points is characteristic for TFT LCD technology. The warranty performance will be granted if more than 15 missing, black, or luminous points are present.

→ Better games through innovation

TAB-Austria Industrie- und Unterhaltungselektronik GmbH & CoKG  
Haider Strasse 40, A-4052 Ansfelden, UID-Nr.: ATU57977639  
Tel. +43 (0)7229/78 040-0, Fax +43 (0)7229/78 660, e-mail: [sales@tab.at](mailto:sales@tab.at), [www.tab.at](http://www.tab.at)



You can get this game at [www.magic-play.eu](http://www.magic-play.eu)



In case of any irregularities in the machine, please check power and all plug-in connections!

In case you cannot remove an error, please call our hotline:

Call +43-7229-780 40 – ext. 250

→ Better games through innovation

TAB-Austria Industrie- und Unterhaltungselektronik GmbH & CoKG  
Haider Strasse 40, A-4052 Ansfelden, UID-Nr.: ATU57977639  
Tel. +43 (0)7229/78 040-0, Fax +43 (0)7229/78 660, e-mail: [sales@tab.at](mailto:sales@tab.at), [www.tab.at](http://www.tab.at)





## Notes

→ Better games through innovation

TAB-Austria Industrie- und Unterhaltungselektronik GmbH & CoKG  
Haider Strasse 40, A-4052 Ansfelden, UID-Nr.: ATU57977639  
Tel. +43 (0)7229/78 040-0, Fax +43 (0)7229/78 660, e-mail: [sales@tab.at](mailto:sales@tab.at), [www.tab.at](http://www.tab.at)



You can get this game at [www.magic-play.eu](http://www.magic-play.eu)

 [www.facebook.com/fun4four](http://www.facebook.com/fun4four)  
 [www.youtube.com/tabaustralia](http://www.youtube.com/tabaustralia)  
 [www.linkedin.com/company/tab-austria](http://www.linkedin.com/company/tab-austria)

TAB Austria Industrie- und Unterhaltungselektronik GmbH & Co KG  
Haider Straße 40, 4052 Ansfelden  
+43 (0) 7229 78040, sales @ tab.at  
[www.tab.at](http://www.tab.at)

➔ Better games through innovation



You can get this game at [www.magic-play.eu](http://www.magic-play.eu)