

**LIFECYCLE, BIOLOGY AND DIVERSITY OF  
*Puccinia boroniae* IN WESTERN AUSTRALIA**



*Boronia* 'Lipstick' in cultivation at Mount Barker, Western Australia

by

**Susanna Driessen**

BSc (Hons) Murdoch University

This thesis is submitted in fulfilment of the requirements for  
the degree of Doctor of Philosophy

School of Biological Sciences and Biotechnology  
Murdoch University, Perth, Western Australia

June 2005

---

## DECLARATION

The work described in this thesis was undertaken while I was an enrolled student for the degree of Doctor of Philosophy at Murdoch University, Western Australia. I declare that this thesis is my own account of my research and contains as its main content work which has not previously been submitted for a degree at any tertiary education institution. To the best of my knowledge, all work performed by others, published or unpublished, has been duly acknowledged.

Susanna Driessen

June 2005

---

## ACKNOWLEDGEMENTS

I would like to thank all the *Boronia* growers who participated in this study, but particularly Jeanette and Phillip Trent. Without their active participation, this research would not have been possible. Their good natured acceptance of my enthusiasm when their *Boronia megastigma* plants became infected and I tried to convince them how “beautiful and special” their rust was, was wonderful. I would also like to acknowledge the Western Australian Department of Agriculture as the industry partner supporting this project.

My deep thanks go to Associate Professor Giles Hardy, whose enthusiasm and passion for all things fungal started me along the road of plant pathology. His supervision and input to this project was inspiring and motivating. I would also like to recognize Dr Phillip O’Brien for his valuable supervision into the molecular aspects of this research.

Much support was received by a long list of colleagues and fellow PhD students at Murdoch University, for which I am indebted. I would particularly like to thank Sarah Jackson for her help in setting up the field trial, accompanying me on many of the field excursions (despite her allergy to *Boronia*), and her constructive criticisms during the review and editing of my thesis. Thanks go to Trudy Paap, Nari Anderson and Susana Pons, who greatly helped in thinking out alternative approaches, raising ideas during the research and generally providing support during the rollercoaster ride that is the PhD. Murdoch technical staff, particularly Ian McKernon, are thanked for their help with organising my greenhouse and growth cabinet needs. I would like to thank Gordon Thomson for his invaluable input into the preparation of the histological and fluorescent specimens, and Dr Paul Barber for showing me how to successfully prepare ‘good’

---

hand sections. Dr Morag Glen is thanked for her technical input and discussions about the molecular aspects of the project.

Last, but by no means least, I would like to thank my parents Heidi and Peter, and my sister Elisabeth. Words cannot express my gratitude for their unwavering support and love during this long road, and to them I dedicate this thesis.

---

## ABSTRACT

The rust fungi (Uredinales, Basidiomycota) are an expansive and diverse group of fungal species, consisting of approximately 7000 different species in over 160 different genera. Fungi of the genus *Puccinia* represent a large proportion of these rust fungi, many species of which are well known for their role in causing massive yield and subsequent economic losses in agricultural crops worldwide. *Puccinia boroniae* is one such rust fungus and is a significant pathogen of several species of *Boronia* (Rutaceae), a native Australian wildflower grown commercially in Western Australia as a cutflower. Complete control of the rust pathogen is rarely achieved using chemical fungicides. Improving the level of disease control is vital for the long-term sustainability and future growth of the *Boronia* industry, and requires an understanding of the pathogen. The objectives of this thesis were to investigate aspects of the epidemiology, the biology and the diversity of *P. boroniae* in Western Australia, providing a broad understanding of the pathogen, which in turn could be employed to improve disease control.

The lifecycle of *P. boroniae* was conclusively shown to be microcyclic by artificial inoculation of *Boronia heterophylla* with basidiospores released from germinating teliospores suspended over the host plant. Telia developed on the leaves within 21 days, with no intermediate rust spore stages (pycnial, uredial or aecial) observed. Rarely, low numbers of pycnia of *P. boroniae* were observed on field specimens collected from leaves of *B. megastigma* cultivated at one commercial floriculture plantation. This was the first record of pycnia of *P. boroniae*; however, as pycnia were not observed on other host species or plantations, or formed during controlled inoculation trials, their functional role in the lifecycle is currently unresolved.

Telia were subepidermal, erumpent and pulvinate, amphigenous on leaves, stems and parts of developing flower buds, and generally persistent year round. Intracellular

---

hyphae resembling monokaryotic haustoria (M-haustoria) were observed in leaf mesophyll cells beneath and adjacent of telia. Occasionally *Sphaerellopsis filum* (teleomorph *Eudarlucacaricis*), a known mycoparasite of rust fungi, was observed on the telia. Under favourable conditions, teliospores germinated immediately without a period of dormancy, with fully mature basidiospores formed within 3–4 h after telia were exposed to moisture. Basidial development in *P. boroniae* was unusual, in that only one basidiospore was formed from each germinating teliospore cell. Immature teliospores were initially binucleate undergoing karyogamy to form a single large (presumably diploid) nucleus that migrated into the developing metabasidium. Both binucleate and tetranucleate metabasidia were observed, with mature uninucleate, binucleate and tetranucleate basidiospores present. At this stage, more research is required to understand the complete nuclear behaviour during teliospore germination. The morphology of the pycnial stage was similar to other *Puccinia* species, being ampulliform, subepidermal, amphigenous and arranged in small clusters on leaves of *B. megastigma*. However, the spine-like periphyses protruded through stomata as apposed to penetrating the leaf epidermis.

Environmental conditions favouring the formation and dispersal of basidiospores were assessed *in vitro* and under field conditions with a spore catcher. Under field conditions, basidiospores were captured from February–August 2004, with peak numbers and daily incidence occurring during autumn (April/May) when the average temperature range was 9.1–22.6 °C. Daily basidiospore numbers were positively correlated with minimum daily temperature and total daily rainfall. A distinct diurnal periodicity of release was observed, with numbers peaking on average between 02:00 and 05:00 hrs. The hourly release of basidiospores was positively correlated with relative humidity and negatively correlated with temperature and evaporation. This data was in agreement with the *in vitro* experimentation, which showed that basidiospore

---

formation occurred between  $10\text{--}25 \pm 1$  °C (apparent optimal temperature of  $15\text{--}20 \pm 1$  °C) with telia incubated in continuous darkness promoting a greater number of basidiospores.

The level of genetic variation of *P. boroniae* in Western Australia was assessed by PCR-RFLP of the nuclear ribosomal intergenic spacer 2 (IGS2) region. Two RFLP profiles were observed, separating three specimens (Group 1) from the remaining population (Group 2). Sequence analysis indicated that point mutations at endonuclease recognition sites were responsible for the changes in RFLP profile. Group 2 specimens had been collected from the same host species (*B. megastigma*) and plantation, and it is suggested that the variant specimens may constitute a subspecies of *P. boroniae*, isolated by geographic location and possibly host (cultivar) specificity. Further analysis, primarily pathogenicity trials, is needed to confirm this.

This study has improved our knowledge regarding the rust fungus *P. boroniae* and has laid strong foundations for future research into several aspects of the biology, epidemiology and population variation. The implications of the key findings of this research, with an emphasis on the management of *P. boroniae* in commercial situations, are discussed.

---

# TABLE OF CONTENTS

Declaration.....	i
Acknowledgments.....	ii
Abstract.....	iv
<b>CHAPTER 1</b> .....	<b>1</b>
<b>General Introduction</b>	
<b>1.1 Introduction</b> .....	<b>2</b>
<b>1.2 <i>Boronia</i> industry in Western Australia</b> .....	<b>2</b>
<b>1.3 Pests and diseases of <i>Boronia</i></b> .....	<b>5</b>
<b>1.4 <i>Puccinia boroniae</i></b> .....	<b>6</b>
1.4.1 Lifecycle of <i>Puccinia boroniae</i> .....	8
1.4.2 Epidemiological aspects of <i>Puccinia boroniae</i> .....	10
1.4.3 Diversity of <i>Puccinia boroniae</i> in Western Australia.....	11
1.4.4 Control methods.....	14
<b>1.5 Project objectives</b> .....	<b>16</b>
<b>CHAPTER 2</b> .....	<b>18</b>
<b>Morphology of <i>Puccinia boroniae</i></b>	
<b>2.1 Chapter Abstract</b> .....	<b>19</b>
<b>2.2 Introduction</b> .....	<b>19</b>
<b>2.3 Materials and Methods</b> .....	<b>20</b>
2.3.1 Collections examined.....	20
2.3.2 Specimen preparation and examination.....	21
2.3.2.1 Telia and teliospores.....	21
2.3.2.2 Teliospore germination and basidiospores.....	22
2.3.2.3 Pycnia and pycniospores.....	23
<b>2.4 Results</b> .....	<b>23</b>
2.4.1 Telial stage.....	23
2.4.2 Teliospore germination and basidiospores.....	29
2.4.3 Pycnial stage.....	29
<b>2.5 Discussion</b> .....	<b>34</b>
2.5.1 Telial stage.....	34
2.5.2 Intercellular hyphae and haustoria.....	35
2.5.3 Teliospore germination and basidiospore stage.....	36
2.5.4 Pycnial stage.....	37
2.5.5 Conclusions about the lifecycle of <i>Puccinia boroniae</i> .....	38
<b>CHAPTER 3</b> .....	<b>40</b>
<b>Genetic variation of <i>Puccinia boroniae</i> assessed by PCR-RFP and sequence analysis of the nuclear ribosomal RNA genes.</b>	
<b>3.1 Chapter Abstract</b> .....	<b>41</b>
<b>3.2 Introduction</b> .....	<b>41</b>
<b>3.3 Material and Methods</b> .....	<b>43</b>
3.3.1 Rust specimen collection and origin.....	43
3.3.2 DNA extraction.....	45
3.3.3 PCR amplification parameters.....	46
3.3.3.1 ITS region.....	46
3.3.3.2 IGS region.....	48



3.3.4	Cloning and sequencing .....	48
3.3.5	Restriction digestions of the ITS and IGS2 regions .....	50
<b>3.4</b>	<b>Results</b> .....	<b>51</b>
3.4.1	ITS region analysis.....	51
3.4.1.1	Analysis of <i>Puccinia boroniae</i> diversity within the Mt Barker plantation.....	53
3.4.2	IGS2 region analysis .....	53
3.4.2.1	RFLP analysis .....	53
3.4.2.2	IGS2 sequence analysis.....	54
<b>3.5</b>	<b>Discussion</b> .....	<b>56</b>
3.5.1	Conclusions .....	60

---

**CHAPTER 4** **61**

**Incidence of airborne basidiospores of *Puccinia boroniae* and their relationship to weather parameters under field conditions**

<b>4.1</b>	<b>Chapter Abstract</b> .....	<b>62</b>
<b>4.2</b>	<b>Introduction</b> .....	<b>62</b>
<b>4.3</b>	<b>Materials and Methods</b> .....	<b>64</b>
4.3.1	Trap plants location and establishment .....	64
4.3.2	Spore catcher establishment and matrix preparation.....	65
4.3.3	Microscopic examination of the spore matrix .....	66
4.3.3.1	Data analysis .....	67
4.3.4	PCR-RFLP protocol for detection of <i>Puccinia boroniae</i> DNA on the spore matrix.....	67
4.3.4.1	DNA extraction from the spore matrix.....	67
4.3.4.2	PCR parameters.....	68
4.3.4.3	Restriction digestion of the nested PCR products .....	69
4.3.4.4	Sequencing of PCR products.....	70
<b>4.4</b>	<b>Results</b> .....	<b>71</b>
4.4.1	Disease development under field conditions .....	71
4.4.2	Airborne basidiospores of <i>Puccinia boroniae</i> and other fungal spores observed on the spore matrix.....	72
4.4.2.1	Daily basidiospore counts and relationship to weather parameters.....	72
4.4.2.2	Periodicity of basidiospore release and relationship to weather parameters .....	74
4.4.3	PCR-RFLP detection of <i>Puccinia boroniae</i> DNA on the spore matrix.....	77
<b>4.5</b>	<b>Discussion</b> .....	<b>82</b>
4.5.1	Lack of disease development on the Boronia trap plants .....	83
4.5.2	Effect of weather parameters on airborne basidiospores of <i>Puccinia boroniae</i> .....	85
4.5.3	PCR detection of airborne basidiospores of <i>Puccinia boroniae</i> .....	89
4.5.4	Conclusions .....	90

---

**CHAPTER 5** **92**

***Sphaerellopsis filum*: Mycoparasite of *Puccinia boroniae*.**

<b>5.1</b>	<b>Chapter Abstract</b> .....	<b>93</b>
<b>5.2</b>	<b>Introduction</b> .....	<b>93</b>
<b>5.3</b>	<b>Material and Methods</b> .....	<b>94</b>
5.3.1	Fungal isolation and culture .....	94
5.3.2	Identification of the mycoparasite.....	95
5.3.2.1	Culture and fungal morphology .....	95
5.3.2.2	ITS region analysis.....	96
<b>5.4</b>	<b>Results</b> .....	<b>96</b>
5.4.1	Culture and fungal morphology.....	96
5.4.2	ITS sequence analysis .....	97
<b>5.5</b>	<b>Discussion</b> .....	<b>99</b>

<b>CHAPTER 6</b>	<b>102</b>
<b>Basidiospore formation, nuclear behaviour during teliospore germination and completion of the lifecycle of <i>Puccinia boroniae</i>.</b>	
<b>6.1 Chapter Abstract</b> .....	<b>103</b>
<b>6.2 Introduction</b> .....	<b>104</b>
<b>6.3 Materials and Methods</b> .....	<b>106</b>
6.3.1 Specimen collection .....	106
6.3.2 Effect of temperature on basidiospore formation of <i>Puccinia boroniae</i> .....	106
6.3.3 Effect of light on basidiospore formation of <i>Puccinia boroniae</i> .....	107
6.3.4 Teliospore germination and nuclear behaviour of <i>Puccinia boroniae</i> .....	107
6.3.4.1 Basidial development over time .....	107
6.3.4.2 Nuclear staining of germinating teliospores and basidiospores .....	108
6.3.5 Whole plant inoculation with <i>Puccinia boroniae</i> basidiospores .....	109
6.3.6 Detached leaf inoculation of resistant and susceptible <i>Boronia</i> spp. with basidiospores of <i>Puccinia boroniae</i> .....	109
<b>6.4 Results</b> .....	<b>110</b>
6.4.1 Effect of temperature and light on basidiospore formation .....	110
6.4.2 Teliospore germination and nuclear behaviour .....	111
6.4.2.1 Time lapse examination of germination and basidiospore formation .....	111
6.4.2.2 Nuclear behaviour during teliospore germination and basidiospore formation .....	114
6.4.3 Whole plant inoculation of susceptible <i>Boronia</i> spp. .....	117
6.4.4 Detached leaf inoculation of resistant and susceptible <i>Boronia</i> spp. .....	117
<b>6.5 Discussion</b> .....	<b>118</b>
6.5.1 Basidial stage development in <i>Puccinia boroniae</i> .....	120
6.5.1.1 Nuclear behaviour during basidial development .....	122
6.5.2 Completion of the lifecycle of <i>Puccinia boroniae</i> .....	125
6.5.3 Conclusions .....	127
<b>CHAPTER 7</b>	<b>128</b>
<b>General Discussion</b>	
<b>7.1 Overview of major outcomes</b> .....	<b>129</b>
<b>7.2 Lifecycle and biology of <i>Puccinia boroniae</i></b> .....	<b>130</b>
7.2.1 Is the pycnial stage of <i>Puccinia boroniae</i> functional in the lifecycle? .....	132
<b>7.3 Variation within the population in Western Australia</b> .....	<b>133</b>
<b>7.4 Limitations of the current research</b> .....	<b>135</b>
<b>7.5 Future research directions</b> .....	<b>136</b>
<b>7.6 Conclusions</b> .....	<b>137</b>
<b>APPENDICES</b>	<b>139</b>
Appendix 1 <i>Puccinia boroniae</i> IGS2 sequence alignment .....	140
Appendix 2 Preliminary studies into stem death in <i>Boronia</i> .....	144
<b>REFERENCES</b>	<b>150</b>

---

**CHAPTER 1**  
**GENERAL INTRODUCTION**



Teliospores of *Puccinia boroniae*

## **1.1 Introduction**

*Puccinia boroniae* is a significant fungal pathogen of *Boronia* in Western Australia. Infection is prevalent amongst most floriculture plantations within the southwest/great southern regions of Western Australia where *Boronia* is grown commercially. Current chemical control methods are relatively ineffective at eradicating the disease, partially due to the lack of knowledge regarding the biology, pathogenicity and diversity of the pathogen. Though the disease does not generally cause plant death, the presence of *P. boroniae* in a crop can drastically limit the number of harvestable stems, resulting in significant economic losses. In addition, access to current and future export markets will be limited unless adequate control methods are determined, affecting the long-term sustainability of the *Boronia* industry in Western Australia. This chapter provides background into the *Boronia* industry in Western Australia, presents the available information and major gaps in our knowledge regarding *P. boroniae*, and outlines the approach and objectives of this thesis.

## **1.2 *Boronia* industry in Western Australia**

*Boronia*, an aromatic flowering shrub of the plant family Rutaceae, is an Australian native wildflower with over 100 species identified, half of which are endemic to Western Australia (Armstrong 1975). Stems of *Boronia* were originally bush picked from native stands during the late 19<sup>th</sup> and early 20<sup>th</sup> century and sold domestically as a cut flower (Plummer 1996). Bush picking of *Boronia* is now restricted and stringently regulated on both crown and private land by the Western Australian Department of Conservation and Land Management (CALM) as part of their conservation of Western Australia's native flora (CALM 2003). Additionally, as bush stands are commonly quite tall and spindly, with a few bare stems topped by a canopy of leaves and flowers (FIG. 1.1A,B), bush harvested stems have a low market value today.



**FIG. 1.1** Natural stands of *Boronia heterophylla* (A) and *Boronia megastigma* (B) located in the southwest of Western Australia. Present in A is Chris Robinson from the Department of Agriculture (Western Australia).

Several species and varieties are now cultivated commercially throughout Australia for the floristry and essential oil industries (Plummer 1996; 1997). Approximately 37 growers cultivate *Boronia* in Western Australia with the majority of growers located in the southwest of Western Australia (AgWA 2001). Most Western Australian growers cultivate *Boronia* for the cutflower market, predominantly for export, with a smaller volume retained for the domestic market. A few growers cultivate *Boronia* for the extraction of essential oil in Western Australia.

*Boronia heterophylla* (FIG. 1.2A) and *Boronia megastigma* (FIG. 1.2B), both endemic to Western Australia, together with a number of different varieties such as 'Moonglow' (FIG. 1.2C), 'Cameo' and 'Lipstick', are currently the predominant species cultivated (Plummer 1996; AgWA 2001). *Boronia* spp. are generally dense growing plants, reaching between 1–3 m in height, though this varies according to the species. In commercial situations, stands are established close together (0.7–1.0 m apart) in single or double rows with an average density of 7 000–10 000 plants per hectare (Lidbetter and Plummer 2004). Fertiliser application, particularly nitrogen, is critical during the vegetative growth period (mid spring to autumn) to ensure adequate stem length is achieved. Harvesting time is short, occurring for around 2 weeks in early



**FIG. 1.2** *Boronia* species and varieties cultivated commercially in Western Australia. **A.** *Boronia heterophylla*; **B.** *B. megastigma*; **C.** *B. heterophylla* 'Moonglow'.

spring (late August–early October). The value of the harvested stems is heavily reliant on stem length (2<sup>nd</sup> grade stem 50–60 cm, 1<sup>st</sup> grade stem 60–70 cm, premium stem > 80 cm) and straightness, percentage of flowers on stem, and general uniformity within bunches (Lidbetter and Plummer 2004). Post-harvest, stems are typically pulsed with a biocide to prolong vase life and treated for diseases/pests as required by the exporter.

Cultivation of *Boronia* spp. in Western Australia is not as extensive in comparison to other native wildflowers species such as *Chamelaucium* spp. (waxflower) and *Anigozanthos* spp. (Kangaroo paw) with the estimated average planting size per plantation less than 0.2 hectares (AgWA 2001). Despite this, the future prospects and growth of the industry in Western Australia and interstate looks promising. Harvested stems have a high acceptance in Japan, the major export market for Australian wildflowers (Brooks 2001; Sutton 2002), with growing market sources in other Asian and European countries. Currently, the USA market is unavailable, due to an

importation ban on all Rutaceae species. Selection and breeding of new varieties through the Western Australian Department of Agriculture and the University of Western Australia (Astarini *et al.* 1999), have resulted in new forms and flower colours, which will also likely increase demand and production (Lidbetter and Plummer 2004).

### 1.3 Pests and Diseases of *Boronia*

Similar to other intensively grown floricultural crops, *Boronia* spp. are susceptible to a number of pests and diseases. Stem and flower damage may be inflicted by insects such as black beetle, stem borers, scales (Lidbetter and Plummer 2004) and psyllids (Mensah and Madden 1993; 1994). The presence of any of these insects is sufficient to cause quarantine problems with export shipments. Pests are controlled through the application of pesticides and growers are directed to contact their local agronomist for information. A post-harvest application of pesticide may also be required; however this is dependant on the exporter and market destination.

Severe plant losses may occur from soil borne diseases caused by *Pythium* spp. and infestation by plant parasitic nematodes (*Meloidogyne* and *Pratylenchus* spp.) (Blaesing and Peterson 2002; Lidbetter and Plummer 2004). Three *Phytophthora* spp. (*P. cinnamoni*, *P. cryptogea* and *P. drechsleri*) have been associated with severe plant losses in *B. heterophylla*, with all species confirmed pathogenic in greenhouse trials (Lidbetter and Plummer 2004). All these soil-borne pathogens have been implicated as possible reasons for the low success rate in re-establishing commercial *B. megastigma* plantations in Tasmania (Blaesing and Peterson 2002). Control of both *Phytophthora* and *Pythium* is difficult, therefore prevention through good site selection is encouraged, as chemicals rarely eradicate the pathogen (Lidbetter and Plummer 2004). Research is being conducted into the efficacy of grafting in *B. heterophylla* to confer resistance to these *Phytophthora* pathogens. *Botrytis* is also a problem, though regular fungicide

treatment during flower formation helps control this disease. Several of the main species/varieties of *Boronia* cultivated commercially are also known hosts of the rust pathogen *P. boroniae*, acknowledged as a significant problem within the industry. Despite the impact that *P. boroniae* has had and continues to have in commercial plantations, little is known about the pathogen.

#### **1.4 *Puccinia boroniae***

*P. boroniae* is an obligate biotrophic fungus belonging to the order Uredinales, an expansive and diverse group of approximately 7000 fungal species, collectively referred to as the rust fungi (Kirk *et al.* 2001). It is one of only three recorded *Puccinia* spp. in Australia in which a Rutaceae plant is the host (McAlpine 1906) and is considered endemic to Australia. The two other *Puccinia* spp. reported on Rutaceae hosts, *P. correae* and *P. eriostemonis*, occur on *Correa* and *Eriostemon* spp. respectively (McAlpine 1906), both members of the same plant tribe as *Boronia*, Boronieaeae (Armstrong 1975).

*P. boroniae* was first described by Hennings (1903) on natural stands of *Boronia spinescens* in the Avon Valley district of Western Australia. However, bush populations of *Boronia* do not appear to suffer the same level of rust affliction as their cultivated counterparts (Rohl *pers comm.*). The higher level of biodiversity that exists in natural populations of *Boronia* due to seed germination may be a factor in their relative resistance. Selection pressure for rust resistance during the natural co-evolution of both fungus and host may be occurring (Anikster and Wahl 1979; Frank 1992).

A subsequent report by Adam (1932) records the occurrence of *P. boroniae* on cultivated *B. megastigma* in Victoria (Australia), with the rust pathogen acknowledged as being the primary factor in wiping out cultivation of *B. megastigma* in Victoria in the early part of the 20<sup>th</sup> century (Plummer 1997). Within Western Australia, the most



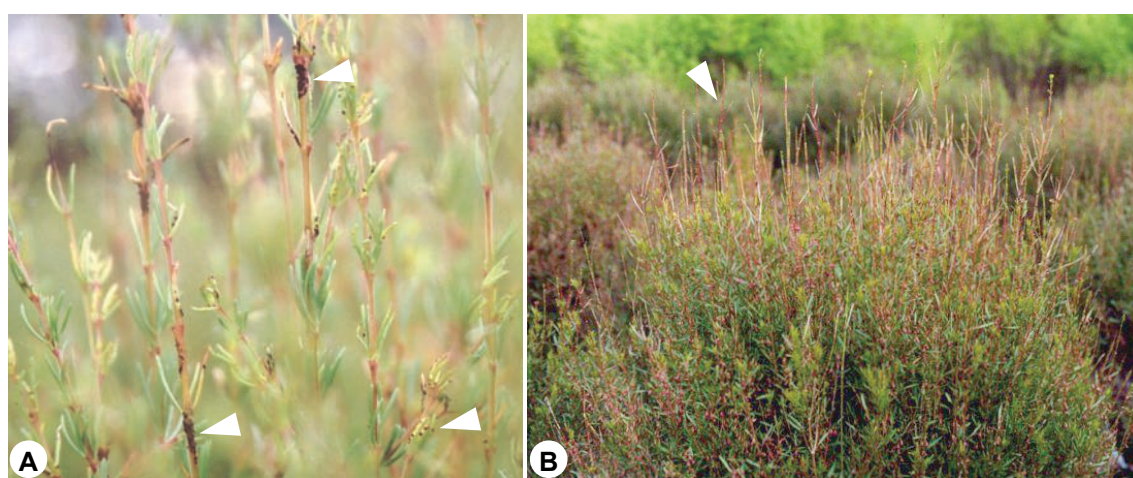
extensively commercially grown species *B. heterophylla* and *B. megastigma* are susceptible to *P. boroniae*, though several of the newer selections of these species have shown resistance to infection under field conditions (TABLE 1.1).

Symptoms of infection are generally restricted to the detection of distinct cinnamon to dark brown (telial) pustules on host leaves or stems (FIG. 1.3A). Infected plants may show no adverse reaction to infection for prolonged periods, with plant death rarely resulting. Eventually infected leaves and flowers drop with defoliation of entire segments of canopy branches occurring in severe cases (FIG. 1.3B).

**TABLE 1.1** Susceptibility of the most common commercially grown *Boronia* species/varieties to *Puccinia boroniae*

Susceptible		Tolerant/Resistant <sup>†</sup>
<i>B. heterophylla</i>	Robinson <i>pers comm.</i>	<i>Boronia</i> 'Lipstick' (unknown hybrid)
<i>B. megastigma</i>	Adam 1932; Sampson and Walker 1982; Cook and Dubae 1989	<i>B. heterophylla</i> 'Moonglow'
<i>B. clavata</i>	Robinson <i>pers comm.</i>	<i>B. heterophylla</i> 'Cameo'
<i>Boronia</i> 'Purple Jarad' ( <i>B. heterophylla</i> x <i>megastigma</i> )	Driessen 2001	<i>B. heterophylla</i> 'Purple Rain'

<sup>†</sup> Resistance based on long-term field observations in which *Boronia* species/varieties remain asymptomatic when susceptible species are infected at the same location.



**FIG. 1.3** Typical symptoms of infection by *Puccinia boroniae* observed in the field.

**A.** Close up of telial pustules (arrows) on infected stems and leaves of *Boronia megastigma*;  
**B.** Defoliation (arrow) of the canopy of a *Boronia heterophylla* plant due to rust infection.

Over the past decade, as the *Boronia* industry has grown in size and planting distribution in Western Australia, the occurrence of *P. boroniae* has increased. Though widespread plant death is not a common occurrence as a result of infection, prolonged plant stress together with the harsh pruning often required to remove the pathogen, productivity from individual *Boronia* stands can potentially be set back 1–2 years. Taking into consideration that the expected commercial plant life is generally less than 6 years (Lidbetter and Plummer 2004), this represents a significant economic loss. Additionally, as infection results in an unsightly stem, covered with brown pustules and lacking leaves, the harvested stem is of no commercial value and therefore is not acceptable for either the export or domestic (Western Australian) markets.

Beyond being visually unappealing, export shipments will also continue to be rejected as a result of stringent quarantine laws in place in the major export destinations. In October 1999, a large consignment of *Boronia* was rejected and subsequently destroyed in Japan due to the presence of telia of *P. boroniae* on the harvested stems (Brown *pers comm.*). The effect of the pathogen is such that growers are opting out of cultivating *Boronia* in favour of other wildflowers. For these reasons, *P. boroniae* is considered an important pathogen of *Boronia* in Western Australia.

#### **1.4.1 Life cycle of *Puccinia boroniae***

Collectively, the rust fungi exhibit one of the more diverse lifecycle patterns among plant pathogenic fungi. Within the genus *Puccinia*, individual species may exhibit between 2 to 5 different spore stages, completing their lifecycle on one host (autoecious) or two host (heteroecious) plant species (Littlefield 1981). The presence of an alternate host in a rust fungus lifecycle has implications in the control of the pathogen, particularly if the alternate host remains unknown. As the diversity of the rust fungi lifecycle is detailed in several reviews and many textbooks (Peterson 1974; Littlefield 1981; Hiratsuka and Sato 1982; Cummins and Hiratsuka 1983; Ingold and

---

Hudson 1993; Mendgen 1997; Figueiredo 2000; Staples 2000; Agrios 2005), it will not be presented here.

The complete lifecycle of *P. boroniae* is currently unconfirmed. Only the telial stage, comprising of two celled teliospores and single celled mesospores, has been observed in the field and described to date (Hennings 1903; McAlpine 1906). Hennings (1903) further described *P. boroniae* as a Leptopuccinia, a microcyclic rust species which germinates without a period of dormancy, though no reference to the germination structures or basidiospores formed was made.

The lifecycle of a rust fungus is traditionally classified according to the spore stages present (Hiratsuka 1973; Hiratsuka and Sato 1982). Therefore, based solely on the presence of the telial stage on infected *Boronia* plants, the lifecycle of *P. boroniae* would be considered microcyclic (teliospores and basidiospores only, with or without pycniospores) as suggested by Hennings (1903). However, as extensive surveys of infected plants have not been undertaken, consideration must be given to the possibility that other spore stages of *P. boroniae* may be present that have not yet been observed, forming a demi- or macrocyclic lifecycle. A biologically unrelated alternate host, on which the unrecorded pycnial or aecial stage would be present, may also be involved in the lifecycle.

Clarification of the lifecycle of different rust species has been achieved through controlled greenhouse and field trials (Groth and Mogen 1978; Harda *et al.* 1996; Weber *et al.* 1998; Edwards *et al.* 1999c; Crane *et al.* 2000a; Anikster *et al.* 2004). However, inoculations with basidiospores of rust species is often troublesome, due to problems associated with teliospore germination (Mendgen 1984; Anikster 1986) and the fragility of the basidiospores (Anikster and Wahl 1985; Ono 2002). One way to overcome these problems is to mimic the natural dispersal of basidiospores from the germinating teliospores (Morin *et al.* 1992b; Morin *et al.* 1993). Controlled inoculation

trials on susceptible host *Boronia* species have not been completed successfully with *P. boroniae* to date (Driessen 2001).

Alternatively, morphological examination of the plant/pathogen interaction may also provide clues into the lifecycle of *P. boroniae*. Due to their biotrophic nature, rust fungi form haustoria (feeding structures) within host cells as a source of nutrients (Rosenzweig and Volz 1999; Mendgen *et al.* 2000; Staples 2001). Two types of haustoria are generally recognized, based on the spore stage initiating infection: monokaryotic (M-haustoria) deriving from basidiospore infection and dikaryotic (D-haustoria) resulting from aeciospore or urediospore infection (Harder and Chong 1984; Quilliam and Shattock 2003). M-haustoria generally appear as undefined intracellular hyphae, morphologically distinct from the more defined, often kidney shaped D-haustoria, and have been described in a number of rust / host interactions (Rijkenberg and Truter 1973; Gold and Littlefield 1979; Larous and Losel 1993; Baka and Losel 1999; Classen *et al.* 2001). Therefore, the presence of M-haustoria within leaf tissue associated with the telial stage would provide strong evidence for a microcyclic lifecycle in *P. boroniae*.

#### **1.4.2 Epidemiological aspects of *Puccinia boroniae***

The epidemiology, including disease development, disease incidence and severity, and the factors affecting disease levels, has been studied extensively for many rust pathogens (Rey and Garnett 1988; Lokhande *et al.* 1998; Edwards *et al.* 1999d; Maffia and Berger 1999; Kolnaar and van den Bosch 2001). The occurrence and dispersal of pathogen inoculum and the relationship to climatic conditions is an important consideration in the dissemination of disease (Meredith 1973; McCartney and Fitt 1998; Campbell 1999; Agrios 2005). As urediospores of rust fungi are responsible for significant disease epidemics worldwide, particularly those with cereal hosts, the factors affecting the dispersal of these spores in field situations have been well documented

(Nagarajan and Singh 1990; Geagea *et al.* 2000; Kumar *et al.* 2000; Sache 2000; Brown and Hovmøller 2002). Aerobiological studies of rust basidiospores have not been as extensively reported in the literature, most likely due to difficulties in identification (Levetin 1990), and their low dispersal capacity (Littlefield 1981) which minimises their role in large scale disease epidemics. Factors affecting teliospore germination, basidiospore formation/germination and subsequent disease development have generally been conducted under controlled laboratory conditions (Pearson *et al.* 1977; Morin *et al.* 1992b; 1992a; Kuhlman and Pepper 1994; Kropp *et al.* 1999; Crane *et al.* 2000b; Flint and Thomson 2000; Longo *et al.* 2000).

According to grower observations in Western Australia, the telial stage of *P. boroniae* generally occurs during the months of autumn (March–May) and spring (late August–November) coinciding with moderate levels of rainfall and mild temperatures in the field. There is a significant lack of information regarding disease development, latent period(s), disease incidence and severity, and dispersal of *P. boroniae* inoculum.

Understanding the factors promoting rust epidemics aids in forecasting of disease and developing models for appropriate fungicide application (Dillard and Seem 1990; Lokhande *et al.* 1998; Edwards *et al.* 1999d; de Vallavieille-Pope *et al.* 2000; Kolnaar and van den Bosch 2001; Shaw 2002), though even a basic understanding and consideration of these factors in crop management can improve the level of disease control achieved.

#### **1.4.3 Diversity of *Puccinia boroniae* in Western Australia**

Traditionally, relationships between rust fungi have been defined based on their lifecycles, morphological differences within the various spore stages, or the pathogen's host range/specificity (*formae speciales* and physiological races) (Littlefield 1981;

Anikster 1984; Roelfs 1984; Edwards *et al.* 1999b). Morphological analysis of the various spore stages is limited in its power to discriminate between closely related species or variation within a species due to the small number of defining characters often available (Harrington and Rizzo 1999) or the absence of particular spore stages. However, several studies have shown that differences in spore and infection structure morphology can define sub-species of rust fungi (Niks and Butler 1993; Swertz 1994; Edwards *et al.* 1999a; Jin and Steffenson 1999; Anikster *et al.* 2004). Host range and specificity analysis is predominantly affected by the availability of infective spores (basidiospores, urediospores or aeciospores) and the development of a successful inoculation method.

Over the past decade, DNA analysis techniques have come into their own in examining diversity within phytopathogen populations. Numerous molecular markers using a variety of techniques have been developed, resulting in improved levels of discrimination between closely related rust species. The polymerase chain reaction (PCR) is widely used and has revolutionised our understanding of the diversity of rust species and plant pathogens in general (Cooley 1991; Henson and Fench 1993; Egger 1995; Bridge and Arora 1998; Edel 1998; Takamatsu 1998). Nuclear ribosomal genes have been used extensively as target sequences. Present in high copy number with both highly conserved and variable segments, these ribosomal regions are ideal for analysis with PCR-based molecular markers (Cooley 1991; Egger 1995; Bridge and Arora 1998; Edel 1998; Takamatsu 1998). The construction of generic rust as well as species-specific primers (Gardes and Bruns 1993) has further improved the utility of this approach, as DNA extracted from small amounts of rust spores may be contaminated with the underlying host plant DNA or DNA of other fungal species associated with the spores.

Field observations have shown that not all *Boronia* spp. are universally susceptible to *P. boroniae*. Certain commercial varieties (selections) of susceptible *Boronia* spp. have shown field based resistance (e.g. *B. heterophylla* 'Moonglow' is resistant, but *B. heterophylla* is susceptible) (Table 1.1). The basis of this resistance is yet to be determined; is the pathogen showing cultivar specificity or are the *Boronia* spp. showing resistance? As an inoculation method for *P. boroniae* has not been determined, these questions currently remain unanswered.

Previous examination of the diversity of *P. boroniae* based on the morphological difference of the teliospores suggested that the rust infecting *B. heterophylla* and *B. megastigma* may constitute two different varieties (Driessen 2001; Driessen *et al.* 2004). However, these data were not supported by DNA analysis. Genetic variation within the nuclear ribosomal internal transcribed spacer (ITS) region, assessed by PCR-RFLP, showed a single homologous profile between all specimens examined. A sole specimen showed minor length variation (< 30 bp) in the PCR product, though the nature of the variation was not assessed during the study. It was concluded that polymorphism within the ITS region was too low to define any intraspecific differences present.

Successful control relies on understanding the fungal population causing disease. Differences in host specificity and the pathogenicity of geographically distinct isolates all contribute to the effectiveness of implemented control methods. Though host specificity plays an important role in the rust fungi, analysing diversity solely at the phenotypic level does not investigate how diverse the fungal population is genetically at loci distinct from virulence/avirulence factors. The level of genetic variation determined using appropriate molecular markers may indicate how quickly a pathogen can evolve and generate new pathotypes (races) (McDonald and McDermott 1993). Furthermore, in rust fungi where only the non-infective spore stage is present (i.e.

teliospores) or the alternate host is unknown, a well characterized virulence / avirulence interaction with different host species may not be established. Molecular markers provide an alternative means of assessing the pathogen diversity. As a successful inoculation method for *P. boroniae* as not been determined, molecular markers are still an appropriate choice in investigating the population diversity within Western Australia, however, alternative DNA regions or genes with greater divergence than the ITS region are required.

#### **1.4.4 Control methods**

Currently the systemic fungicides Tilt® (active ingredient propiconazole) and Mancozeb® (active ingredient mancozeb) are used in Western Australia to control *P. boroniae* on susceptible species. Only Tilt® is registered for use, though trials completed by the Western Australian Department of Agriculture indicated that Mancozeb® provides a greater level of control (Robinson *pers comm.*). Growers either spray prophylactically with Mancozeb® (fortnightly) during the months in which rust typically becomes a problem (spring and autumn) or alternatively spray with Tilt® only once the onset of the disease becomes apparent (when telia initially become visible). Prophylactic spraying generally results in a higher success rate in controlling the pathogen, though both approaches rarely eradicate the pathogen from the crop. Several pertinent issues are raised with the continual application of fungicides, primarily:

- Limited resources to spray continually. As *Boronia* is generally grown in conjunction with other commercial wildflower species, the cost in time and money must always be balanced against the eventual return expected.
- Occupational health and safety issues from repeated exposure to toxic chemicals, and environmental concerns resulting from high and repeated level of chemical application (Knight *et al.* 1997).



- Chemical residuals from fungicides in *Boronia* extracts from plants cultivated for the essential oil market (Groenewoud *et al.* 1995).
- Concerns about future development of fungicide resistance (Knight *et al.* 1997). Unfortunately, growers often fail to sufficiently rotate their chemical groups, and the development of resistance is a major concern.

With the increasing number of commercial varieties/selections of *Boronia* available, growers can now chose to cultivate those which currently show resistance to *P. boroniae* (TABLE 1.1). However, several drawbacks to this approach are present; (i) market acceptance and demand for these new varieties is yet to be established in many cases, (ii) replacing established plants with new stock results in 2–3 years before productivity reaches commercially viable levels, and (iii) as the basis for resistance is unknown, previously resistant varieties may eventually show susceptibility.

In the past, growers were encouraged to seed germinate their *Boronia* plants and select for rust resistant varieties to use as stock plants for stem propagation (Adam 1932). Though partially successful at the time, this form of selecting for resistance has commercial limitations. As introduced earlier (SECTION 1.2) uniformity within the planting material is essential, such that desired market characteristics including harvesting time, flower quality and stem length are meet. As greater variability occurs in *Boronia* germinated from seed, vegetatively propagated stock material is now generally obtained from commercial sources (Plummer 1997). The resulting genetic uniformity of the planting material ensures that the characteristics of the chosen marketable selection are maintained throughout the crop. However, the genetic uniformity present predisposes the entire crop of susceptible *Boronia* species/varieties to infection by *P. boroniae*.

Control of rust species is generally implemented through a combination of breeding/planting resistant plant varieties (Pataky and Headrick 1989; McIntosh and Brown 1997; Gupta *et al.* 1999; Asnaghi *et al.* 2001; Wilson *et al.* 2001) and fungicide application (Clarkson *et al.* 1997; Struck *et al.* 1998; Staples 2000; Koike *et al.* 2001; Mueller *et al.* 2004). In heteroecious species, attempts to eradicate the alternate host as a form of control, thereby restricting continuation of the lifecycle, has met with varying results (Maloy 1997; Staples 2000). Mycoparasitic fungi such as *Sphaerellopsis filum* (Yuan *et al.* 1999; Pei *et al.* 2003), are being studied as alternatives/additions to fungicides. Crop management techniques, such as planting density, cultivar mixture and fertilization (Ash and Brown 1991; Pedroza *et al.* 1994; Finckh *et al.* 2000; Avelino *et al.* 2004), and their effect on rust disease incidence and severity are also important factors being investigated. However, all these disease management techniques rely on understanding the causative agent, in particular its biology and epidemiology.

## **1.5 Project objectives**

In order to sustain the current industry and allow for future expansion, improved disease management is vital. No in-depth examination of *P. boroniae* has been undertaken, thus the major obstacle in effective control of *P. boroniae* is the lack of knowledge in essentially all aspects of the pathogen; its lifecycle, inoculum dispersal and disease development in the field, meteorological factors favouring disease, its biology, host specificity and diversity. Improved timing of fungicides could be implemented based on the disease cycle and biology of *P. boroniae*. This in conjunction with regular monitoring for early signs of infection (prior to fully mature telia forming), appropriate choices in stock material, and education into the likely transport of the pathogen throughout Western Australia, would improve the level of disease control. Therefore, the objectives of this thesis were to;

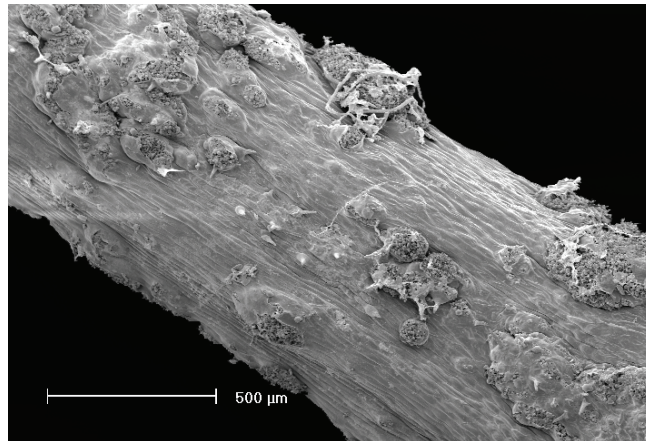
- elucidate all spore stages involved in the lifecycle of *P. boroniae* under field conditions and provide a current morphological description of each spore stage (CHAPTER 2),
- document the presence of any mycoparasitic fungi associated with *P. boroniae* (CHAPTER 5),
- examine the level of diversity within the population in Western Australia through the development of molecular markers (CHAPTER 3).
- investigate the development of disease and the climatic conditions conducive for inoculum dispersal under field conditions (CHAPTER 4),
- investigate the biology of the telial stage of *P. boroniae* including the environmental conditions conducive for basidiospore formation (CHAPTER 6), and
- report the lifecycle of *P. boroniae* through *in vitro* inoculation trials (CHAPTER 6).

In addition, to improve the overall health of *Boronia* in commercial situations in Western Australian, any additional fungal pathogens present during this research period will be examined (APPENDIX 2).

---

## CHAPTER 2

### MORPHOLOGY OF *PUCCINIA BORONIAE*



SEM of a *Boronia heterophylla* stem showing scattered erumpent telia of *Puccinia boroniae*

**Published as:** Driessen SA, O'Brien PA, Hardy, GEstJ. Morphology of the microcyclic rust fungus *Puccinia boroniae* revisited. *Mycologia*. (in press)

## 2.1 Chapter Abstract

The morphology of the telial and pycnial spore stages, and teliospore germination characteristics of the rust pathogen *Puccinia boroniae* were examined by light and scanning electron microscopy. Herbarium and freshly sampled specimens from various commercial *Boronia* plantations in Western Australia were examined. Telia were subepidermal, erumpent and pulvinate, amphigenous on leaves, stems and parts of developing flower buds. Intracellular hyphae typical of monokaryotic haustoria were observed in the mesophyll cells beneath and adjacent to telia. Teliospores germinated immediately to produce a septate metabasidium on which a single, ovate to elliptical basidiospore developed on a sterigma at the sub-terminal end. Observation of the pycnial stage of *P. boroniae* was restricted to a single commercial plantation on the leaves of *Boronia megastigma*. Bright orange pycnia were present in clusters on both the adaxial and abaxial leaf surface. Their structure conformed to the type 4 as described by Hiratsuka and Cummins (1963), typical of *Puccinia* spp. It is unknown whether the pycnial stage is still functional in the lifecycle of the rust fungus. Urediospores and aeciospores were not observed on any specimens examined.

## 2.2 Introduction

*Puccinia boroniae* was first described by several authors in the beginning of the 20<sup>th</sup> century (Hennings 1903; Sydow and Sydow 1904; McAlpine 1906). All descriptions are similar, and only documented the telial stage (teliospores and mesospores, and the gross morphology of the telium) of the rust fungus from one specimen (on branches of *Boronia spinescens* Benth. from Western Australia, collected by L. Diels). These records also describe *P. boroniae* as a Leptopuccinia; a microcyclic rust fungus in which mature teliospores germinate without a period of dormancy. However, descriptions of the germination structures and basidiospores were not recorded.

No modern descriptions of *P. boroniae* are recorded subsequent to these, a likely reflection of the low economic importance of the host plant *Boronia* prior to extensive commercial cultivation. The objective of this study was to provide a current and more detailed morphological description of the various spore stages of *P. boroniae* observed in the field and to describe the teliospore germination structures and basidiospores. Comparison of the morphological data with that documented for other rust fungi and the likely lifecycle of *P. boroniae* are discussed.

## 2.3 Materials and Methods

### 2.3.1 Collections examined

Fortnightly to monthly examinations of susceptible *Boronia* spp. grown on commercial plantations in the great southern region of Western Australia were made between February 2003 and July 2004. Fresh specimens were examined for spore, sorus and teliospore germination. Herbarium species of *P. boroniae* teliospores, collected from within the same region, were also examined (TABLE 2.1). Colour designation of the various sori stages was made from Kornerup and Wanscher (1967).

**TABLE 2.1** Collection details of *Puccinia boroniae* specimens from Western Australia examined in this study.

Specimen code	Herbarium number†	Host	Location	Collection date	Spore stage
M05	WAC12424	<i>B. megastigma</i>	Mount Barker (34° 34'S, 117° 46'E)	May 2000	Telial
M0204	WAC12426	<i>B. megastigma</i>	Mount Barker (34° 34'S, 117° 46'E)	Feb 2004	Telial/pycnial
B09	WAC12427	<i>B. clavata</i>	Redmond (34° 54'S, 117° 33'E)	Jun 2000	Telial
H0704	WAC12425	<i>B. heterophylla</i>	Albany (35° 01'S, 117° 50'E)	Jul 2004	Telial
H10	WAC12428	<i>B. heterophylla</i>	Redmond (34° 54'S, 117° 33'E)	Jun 2000	Telial

† Western Australian Department of Agriculture Plant Pathogen Collection  
Western Australian Herbarium (PERTH) numbers pending

## 2.3.2 Specimen preparation and examination

### 2.3.2.1 *Telia and teliospores*

Teliospores of dried and freshly collected *P. boroniae* specimens were scraped from several sori, mounted in lactoglycerol on glass slides and gently heated to expand collapsed spores. Prepared slides were examined with bright field and differential interference contrast optics (DIC) on an Olympus BH-2 microscope equipped with an Olympus DP10 digital camera. The percentage of single celled teliospores (mesospores) in each specimen was quantified by counting the number of mesospores in 4 fields of view at 200× magnification. Spore dimensions (length and width) were obtained by photographing random fields of view at 400× bright field magnification on an Olympus BX51 microscope attached to a MicroPublisher 3.3 RTV photographic unit (Olympus, Australia) and analysing the length and width of 47 spores with Olysia BioReport Imaging Software version 3.2 (Olympus, Australia). Differences between the means of each specimen was tested with a one-way ANOVA using the software SPSS (version 12.0.1, SPSS Inc., Chicago).

The structure of the telium and the inter/intracellular fungal structures was visualized in cleared and stained, stained (uncleared) and unstained hand sections of fresh leaf and stem material. Vertical sections were obtained using a razor blade under a dissecting microscope, with plant material immobilized on glass slides using double-sided sticky tape (due to the small size of the plant material). For the clearing process, telial sections were adhered to glass slides by initially floating the sections on water droplets on adhesive coated glass slides that were then gently heated to evaporate the water.

Cleared and stained sections were prepared using a modified version of the methods of Quilliam and Shattock (2003), in which the sections were cleared overnight in an aqueous saturated chloral hydrate (2.5 mg.ml<sup>-1</sup>) solution, washed twice in distilled

water, stained with 0.1% lactoglycerol cotton blue for 15–30 min, rinsed in distilled water and mounted in lactoglycerol. Stained (uncleared) and unstained sections were mounted directly in 0.05% lactoglycerol cotton blue and lactoglycerol, respectively. All sections were viewed under oil at 1000× on an Olympus BH-2 using both bright field and DIC optics and photographed with an Olympus DP10 digital camera. Images were edited for clarity where necessary with Adobe Photoshop® 7.0.

The surface morphology of the telia on leaves and stems was examined by scanning electron microscopy (SEM). Several telia were hand sectioned through the middle prior to fixation. Specimens were fixed overnight at 4 °C in 3% glutaraldehyde in 0.025M phosphate buffer (pH 7.0), washed several times in buffer and dehydrated in a graded series of ethanol (30, 50, 70, 90 and 100%) ending with amyl acetate. Each specimen was critical point dried, adhered to an aluminium stub with carbon paste, splutter coated with gold in a Balzers Union SCD 020 (Balzers Union Ltd, Liechtenstein) and examined under a Philips XL20 SEM at 10–15kV.

#### 2.3.2.2 *Teliospore germination and basidiospores*

Freshly collected leaves bearing telia were soaked for 1–4 hours in sterile distilled water at  $15 \pm 1$  °C in the dark and blotted dry with sterile filter paper to remove excessive water. Preliminary studies had shown that teliospore germination and basidiospore formation was optimal at temperatures  $15\text{--}20 \pm 1$  °C under dark conditions (CHAPTER 6). Therefore, intact telia retained on the host leaves were incubated in sealed petri dishes lined with moist filter paper and incubated at 15 and  $20 \pm 1$  °C in the dark. Germination was also assessed on whole telia detached from the underling plant material by placing detached telia upright onto 2 % distilled water agar plates and incubating at 10, 15, 20 and  $25 \pm 1$  °C in the dark. After 24 h incubation germinating teliospores were gently teased from the sorus with a fine needle, mounted in



lactoglycerol and viewed under bright field and DIC as previously described. Discharged basidiospores surrounding the removed telium on the surface of the DWA plates were mounted in 0.05% lactoglycerol aniline blue and viewed as previously described for the teliospores, with the length and width of 80 basidiospores measured.

### 2.3.2.3 *Pycnia and pycniospores*

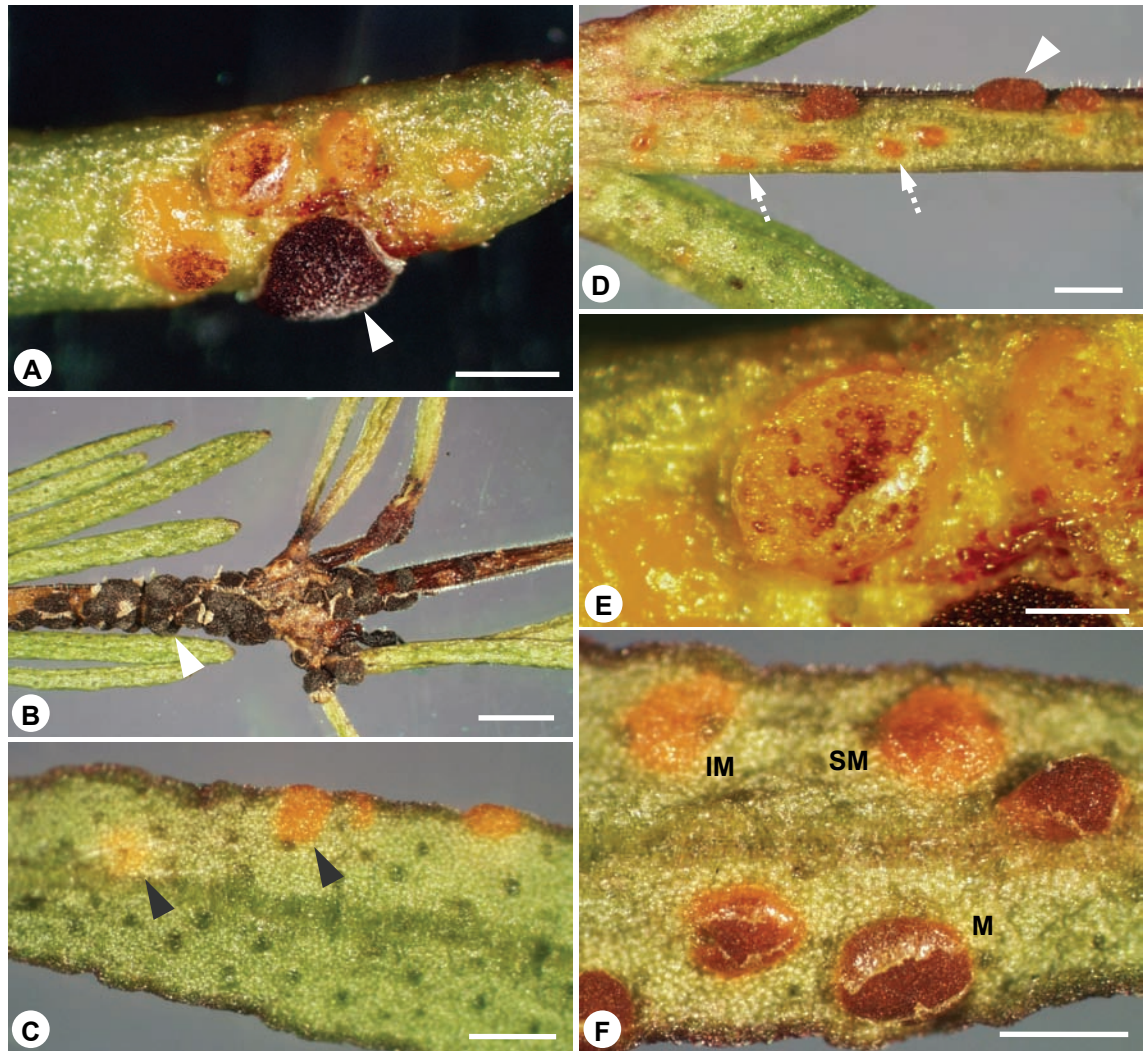
Specimen M0204 (and subsequent collections on *B. megastigma* from this plantation) showed a previously unrecorded pycnial stage. Pycniospores and the pycnium structure were visualized in stained and unstained hand sections, prepared as described for the telial stage (SECTION 2.3.2.1).

## 2.4 Results

### 2.4.1 Telial stage

Telia were amphigenous, scattered or moderately concentric (FIG. 2.1A), present predominantly on younger leaves of infected *Boronia* spp., though stem infections were not uncommon. Field observations made during the flowering season (August–late September) showed telia present on the peduncle and sepals of developing flower buds. Specimens M05 and M0204 on host species *B. megastigma* showed a heavier level of stem infection, with large clusters of telia present, often girdling the infected section of the stem (FIG. 2.1B). Telia were erumpent and pulvinate, first appearing as a light yellow discoloration flat on the host surface (FIG. 2.1C), gradually darkening and becoming erumpent (FIG. 2.1D). Mature telia erupted through the epidermal layer, becoming reddish brown (9E7–8) to dark brown (9F6–8) in colour (FIG. 2.1E, F), individually up to 2.5 mm in size, often surrounded by the ruptured epidermis (FIGS 2.1F & 2.2A). No paraphyses were observed. Telia of freshly collected specimens occasionally appeared white due to the production of germination structures, with older pustules often colonised by saprophytic fungi, appearing brownish grey. Specimens

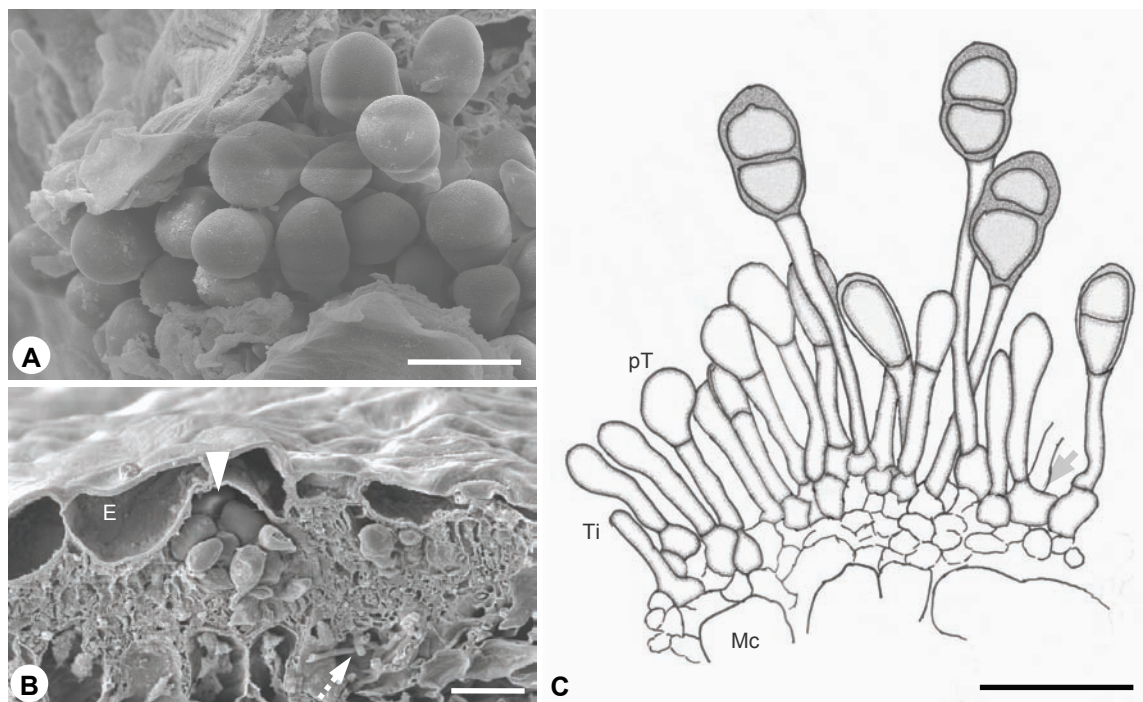
from one location were parasitised by a mycoparasitic fungus, identified as *Sphaerellopsis filum* (teleomorph *Eudarluca caricis*) (CHAPTER 5).



**FIG. 2.1.** Maturity stages of telia of *Puccinia boroniae* on leaves and stems of *Boronia heterophylla* and *B. megastigma* (specimens H0704 and M0204).

**A.** Concentric pattern of mature (brown) and immature (yellow) telia on the abaxial surface of a *B. megastigma* leaf. Whitish surface of mature telium (arrow) due to the presence of germination structures. Bar = 1 mm; **B.** Confluent telia (arrow) on stem of *B. megastigma*. Bar = 5 mm; **C.** Early development of telia (arrows) on adaxial surface of a *B. heterophylla* leaf. Bar = 1 mm; **D.** Scattered immature (broken arrow) and mature (arrow) telia on *B. heterophylla*. Bar = 1 mm; **E.** Semi-mature erumpent telium surrounded by ruptured epidermis with small number of mature (dark brown) teliospores in the middle of the telium. Bar = 0.5 mm; **F.** Moderately flat immature (IM) telium, semi-mature (SM) telium in which the epidermis of the leaf has not been broken, and mature (M) erumpent telium with large numbers of mature (brown) teliospores. Bar = 1 mm.

Transverse sections revealed a subepidermal telium, with teliospores arising from a dense pseudoparenchymatous layer up to 20  $\mu\text{m}$  thick located between the mesophyll and epidermis in leaf infections (FIG. 2.2B), and the cortex and epidermis in stem infections. The basal layer was composed of globulus to angular hyaline sporogenous cells 4–6  $\mu\text{m}$  in diameter, from which aseptate, hyaline, cuboidal to rectangular teliospore initials arose (FIG. 2.2C). A septum formed across these cells, forming a pedicel cell and the primary teliospore (FIG. 2.2C), which was initially rectangular, unicellular and hyaline, broadening with maturity to become more ellipsoid, two celled and pigmented.

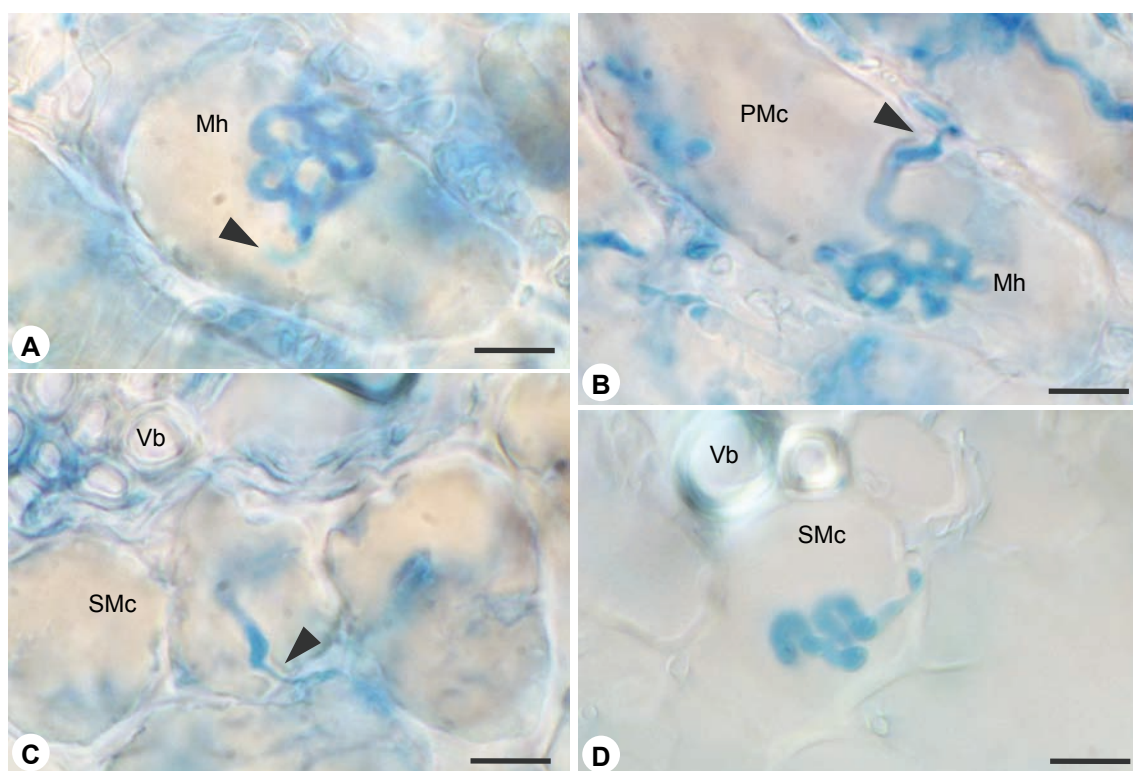


**FIG. 2.2.** Telium structure and teliospore development of *Puccinia boroniae*. Bar (all) = 20  $\mu\text{m}$ .

**A.** Mature teliospores erupting through the epidermis of a *Boronia megastigma* leaf; **B.** Sectioned telium from the same specimen as **A**, showing subepidermal position, with mature teliospores (arrow) present which have not yet ruptured through the epidermis (E). Intercellular hyphae are visible in the mesophyll cells directly below the telium (broken arrow); **C.** Line drawing of telium section showing teliospore initial (Ti), primary teliospore (pT) and fully mature (pigmented) teliospores developing from sporogenous cells (arrow).



Septate hyaline inter- and intracellular hyphae ramified between and through the epidermal and mesophyll cells, but were not seen to enter the cells of the vascular tissue. Intracellular hyphae resembling monokaryotic haustoria (M-haustoria) were observed in the host mesophyll cells beneath and adjacent to the telium. These intracellular hyphae were coiled and branched (FIG. 2.3A,B), characterised by a well defined constriction region (neck band) at the entry point into the host cell (FIG. 2.3B,C,D), surrounded by the host plasmalemma and terminating within the infected cell.



**FIG. 2.3.** Light microscopy of cross sections of *Boronia* host tissue beneath telia of *Puccinia boroniae*, showing intracellular M-haustoria (sections cleared and stained). Bar (all) = 10  $\mu$ m.

**A.** Extensively curved and branched M-haustorium (Mh) in spongy mesophyll cell. Host cell penetration point (arrow) visible by shifting plane of focus; **B and C.** M-haustoria (Mh) in palisade mesophyll (PMc) and spongy mesophyll (SMc) cells showing constricted neckband region (arrow) surrounded by the extrahaustorial membrane. Vb = Vascular bundle cells; **D.** Uncleared (stained) section showing coiled haustorium within a mesophyll cell adjacent to the vascular bundle (Vb).

Teliospores were cinnamon to rust brown, smooth, pedicellate, broadly ellipsoidal and slightly constricted at septum (FIG. 2.4E,H), predominantly 2-celled, (22–) 24–35 (–37) × (13–) 14–19 (–20) μm (average  $28.8 \pm 2.8 \times 16.6 \pm 1.4$  μm; n = 235) (FIG 2.4A,B,H, TABLE 2.1) with highly significant ( $p < 0.01$ ) differences in length and width between specimens. Three celled (FIG 2.4B,E,F,I), rarely 4-celled teliospores (FIG 2.4G) were occasionally observed. The septum was generally inserted horizontally though occasionally oblique or vertical (FIG. 2.4D,F). Single germ pores were present in each cell, apical in upper cell and septal in lower cell (FIG. 2.4I). Pedicles were persistent, hyaline to pale yellow, up to 130 μm, attached at the bottom of the basal cell, occasionally obliquely or laterally present (FIG. 2.4C).

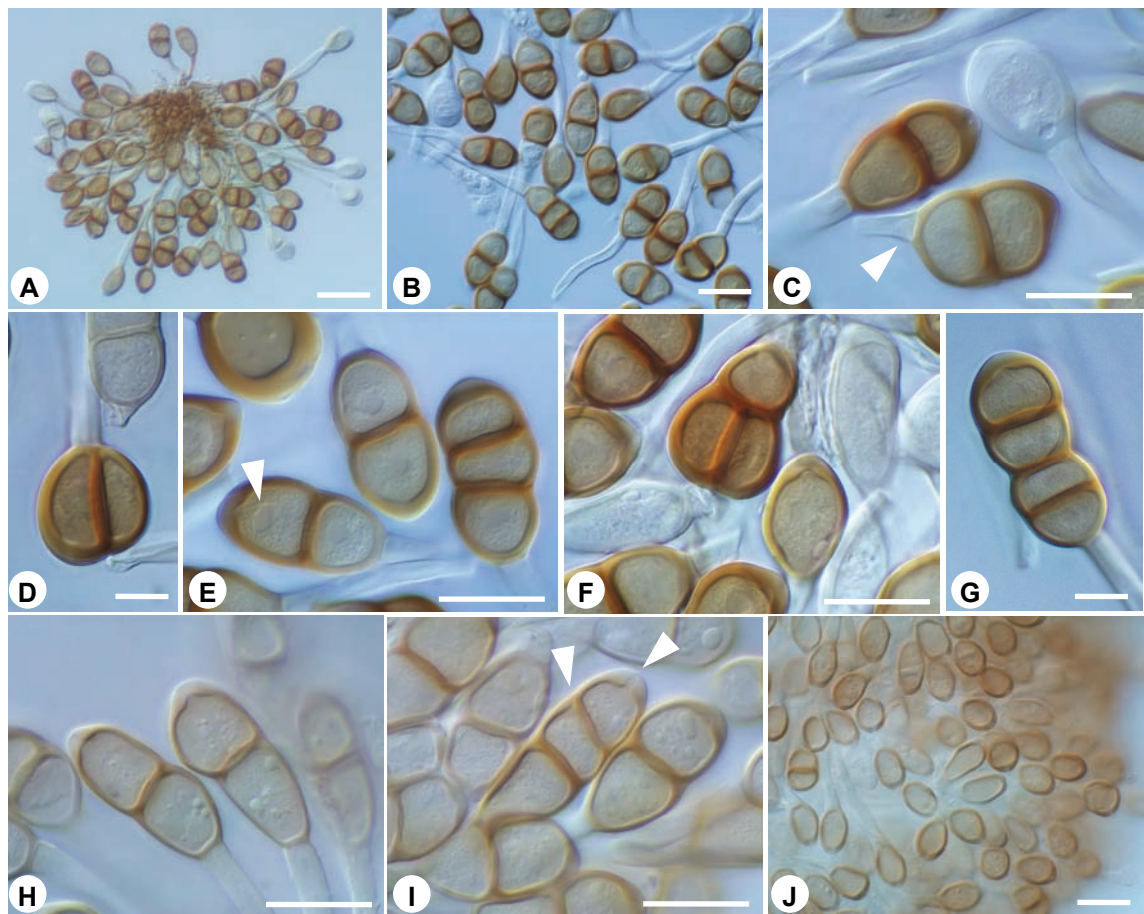
Mesospores were ellipsoid to obovoid, similar colouration to teliospores (FIG. 2.4B,J), 18–29 (–32) × 13–18 (–20) μm (average  $25.3 \pm 3.1 \times 15.7 \pm 1.9$  μm; n = 99) (FIG. 2.4A,F,J, TABLE 2.1). Mesospore percentages varied between specimens and within telial pustules from the same specimen (TABLE 2.1). A high percentage of

**TABLE 2.1.** Morphological dimensions of *Puccinia boroniae* teliospores and mesospores collected from *Boronia* hosts.

Specimen code (Host)	Teliospores dimensions (μm)		Mesospores dimensions (μm)		
	Length range (mean)	Width range (mean)	%	Length range (mean)	Width range (mean)
M05 ( <i>B. megastigma</i> )	25.9–35.0 (30.4 ± 2.0)	15.3–19.2 (17.3 ± 0.9)	18.5	25.5–29.6 (27.8 ± 1.3, n=13)	14.9–18.6 (16.4 ± 1.1, n=13)
M0204 ( <i>B. megastigma</i> )	25.6–34.7 (30.0 ± 2.3)	15.2–20.2 (17.8 ± 1.1)	18.5	20.9–31.7 (24.9 ± 2.0, n=37)	14.2–20.1 (17.4 ± 1.3, n=37)
B09 ( <i>B. clavata</i> )	25.7–37.4 (29.0 ± 2.3)	14.6–19.5 (16.7 ± 1.0)	< 1.0	nd	nd
H0704 ( <i>B. heterophylla</i> )	22–35.4 (29.7 ± 3.1)	12.7–17.1 (15.2 ± 1.0)	1–90	17.7–27.5 (21.4 ± 2.1, n=48)	12.5–18.7 (14.2 ± 1.2, n=48)
H10 ( <i>B. heterophylla</i> )	21.6–33.3 (26.5 ± 2.2)	13.5–17.8 (16.1 ± 0.9)	< 1.0	nd	nd

nd – not determined

mesospores consistent across telia examined from specimens M0204 and M05 was recorded, whereas data from specimen H0204, which also presented a high percentage of mesospores, were dominated by a few individual telia in which 90 % of the spores were mesospores (FIG. 2.4J, TABLE 2.1).



**FIG. 2.4.** Differential interference contrast images of *Puccinia boroniae* teliospores and mesospores mounted in lactoglycerol (specimens M05, M0204 and H0704).

**A.** Mature (pigmented) and immature (hyaline) teliospores and mesospores from specimen M05. Bar = 50  $\mu\text{m}$ ; **B.** Teliospores and mesospores of specimen M0204. Bar = 25  $\mu\text{m}$ , **C–G.** Teliospores/mesospores of specimen M0204 showing variation in pedicle insertion (**C**, arrow), septum insertion (**D**) and cell number (**E**, **F**, **G**). Nuclei are clearly visible in the cells in **E** (arrow). Bar (**D**&**G**) = 10  $\mu\text{m}$ , (**E**&**F**) = 20  $\mu\text{m}$ ; **H and I.** Teliospores of specimen H0204 showing variability in form (more elongated and paler pigment than previous specimens). Note germ pores in apical and 2<sup>nd</sup> cell (arrows). Bar = 20  $\mu\text{m}$ ; **J.** Masses of mesospores from a single telium (specimen H0204). Bar = 25  $\mu\text{m}$ .

### 2.4.2 Teliospore germination and basidiospores

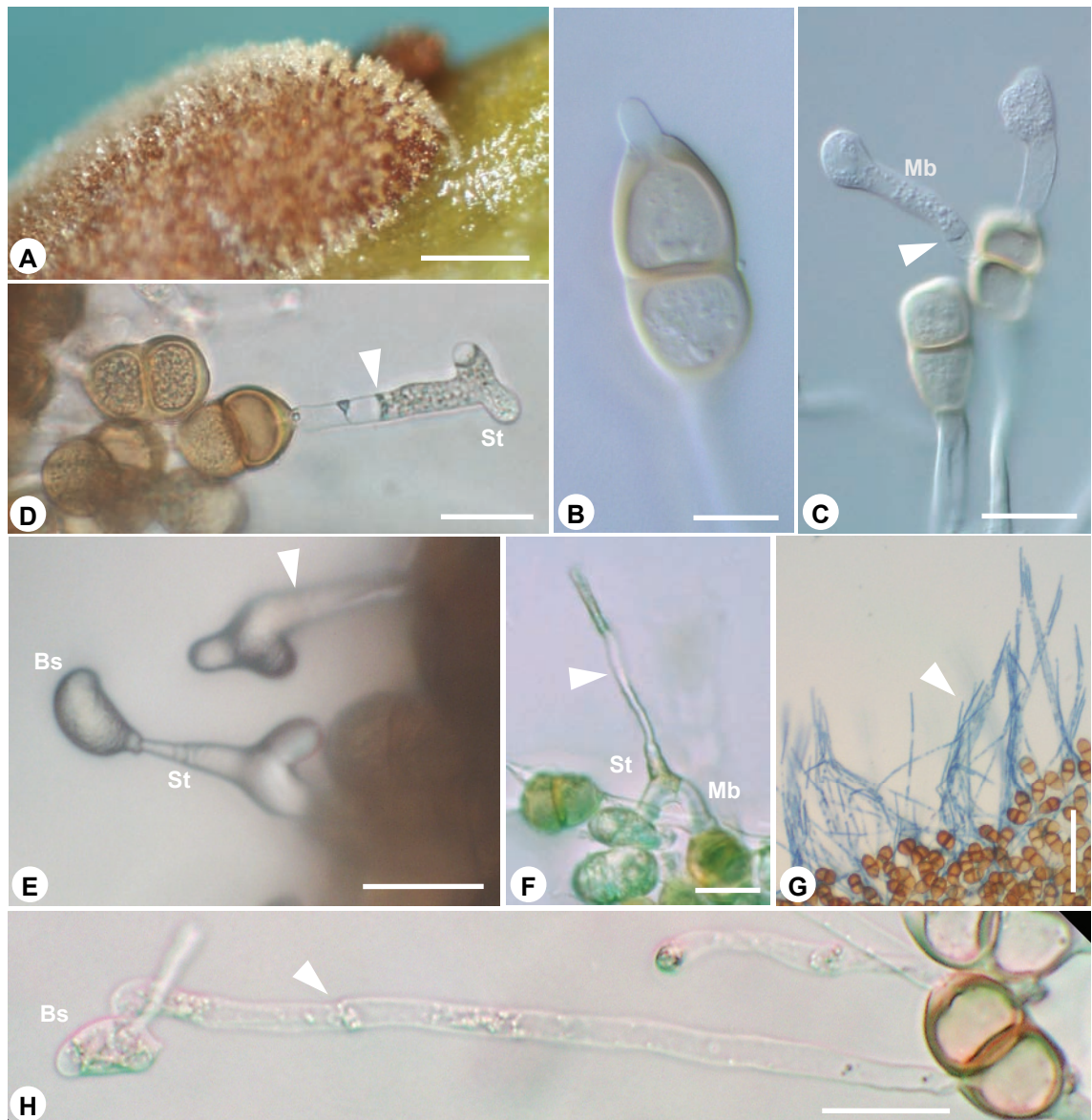
Mature teliospores germinated readily under the given conditions without a period of dormancy (FIG. 2.5A). Asynchronous teliospore germination was common, with apical cells typically germinating before basal cells (FIG. 2.5B). Elongated metabasidia developed into which the spore contents moved. A single septum formed behind the spore contents in the majority of metabasidia prior to the formation of the sterigma, though some remained aseptate (FIG. 2.5C). The terminal end of the metabasidium was observed to curve, followed by the formation of a single sterigma on the sub terminal end of the metabasidium into which the cell contents moved (FIG. 2.5D). A single basidiospore formed at the end of the sterigma (FIG. 2.5E) though occasionally elongated whip-like germ tubes were produced at the end of the sterigma instead (FIG. 2.5F). Extensive metabasidia developed, with or without the formation of basidiospores, when excessive water was retained on the telia (FIG. 2.5G,H).

Basidiospores were ovate to elliptical with a prominent apiculus (FIG. 2.6A),  $13.5\text{--}18.6\ \mu\text{m} \times 8.8\text{--}11.7\ \mu\text{m}$  (average  $16.4 \pm 1.0\ \mu\text{m} \times 10.5 \pm 0.6\ \mu\text{m}$ ;  $n = 80$ ). Basidiospores attached to the sterigma and those cast onto the water agar germinated (FIG. 2.6B,D), often producing excessively long germ tubes up to  $60\ \mu\text{m}$  in length. The occasional formation of secondary basidiospores (FIG. 2.6C,D) was also observed, with excessive free water on or around the telial pustule associated with an increase in the number of secondary basidiospores produced.

### 2.4.3 Pycnial stage

Pycnia of *P. boroniae* were observed on infected *B. megastigma* leaves (specimen M0204) at the Mt Barker plantation in February 2004 (and subsequent collections from this site and host species). This is the first record of the pycnial stage of *P. boroniae*, with no other collections from different host species or locations in Western Australia observed to exhibit the pycnial stage.

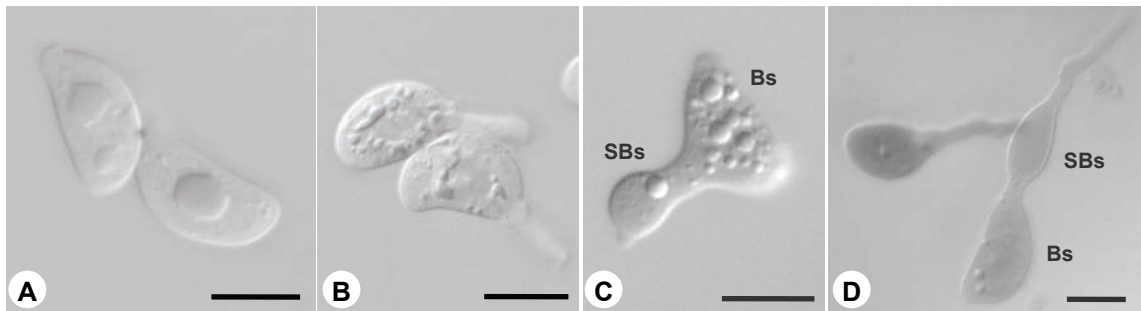




**FIG. 2.5.** Teliospore germination and basidiospore formation of *Puccinia boroniae*.

**A.** Mature telial pustule with masses of metabasidia covering the pustule surface. Bar = 0.5 mm; **B.** Early metabasidium development from the apical teliospore cell. Bar = 10  $\mu$ m; **C.** Mid-stage germination in which the terminal end of both metabasidia (Mb) have begun to curve, characteristic of the beginning of sterigma development. Note the septum (arrow) in the left metabasidium and the absence of septae in the right metabasidium. Bar = 20  $\mu$ m; **D.** Sterigma (St) development at the subterminal end of the metabasidium, with cytoplasmic contents moving into the developing sterigma. Arrow indicates single septum. Bar = 20  $\mu$ m; **E.** Mature basidiospore (Bs) attached to sterigma (St) with developing sterigma in the background. Arrow indicates a septum in the metabasidium. Bar = 20  $\mu$ m; **F.** Formation of a narrow whip-like germ tube (arrow) on the sterigma (St) instead of a basidiospore. Mb = metabasidium. Bar = 20  $\mu$ m; **G.** Excessive vegetative growth (arrow) of metabasidia from teliospores remaining submerged in H<sub>2</sub>O. Bar = 100  $\mu$ m; **H.** Excessively long metabasidium with a single germinating basidiospore attached at the terminal end (sterigma out of plane of focus). Arrow indicates septum. Bar = 20  $\mu$ m.



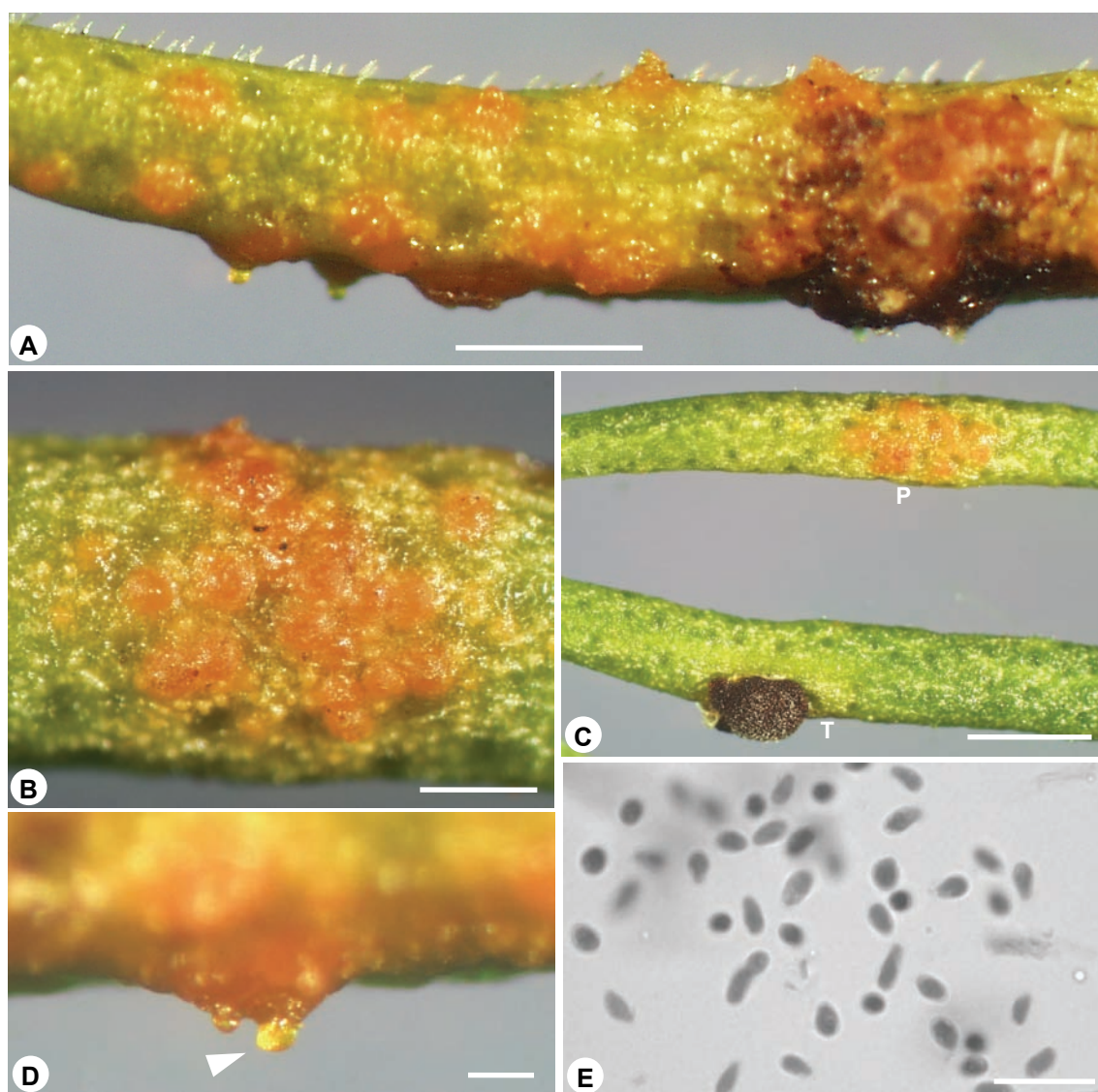


**FIG. 2.6.** Basidiospores of *Puccinia boroniae* and their germination characteristics. Bar (all) = 10  $\mu\text{m}$ .

**A.** Non-germinated basidiospores and **B.** germinating basidiospores on 2% DWA. **C.** Early formation of a secondary basidiospore (SBs) from a germinating basidiospore (Bs); **D.** Secondary basidiospore (SBs) germinating whilst attached to primary basidiospore (Bs), with basidiospore showing normal germination pattern present.

Pycnia were amphigenous, yellowish orange (4A7–8) to orange (6A8/B8), arranged in small clusters, with older pycnia appearing dark brown to black (FIG. 2.7A,B), individually up to 350  $\mu\text{m}$  wide. No pycnia were noted on stems infected with telia of *P. boroniae*. Formation of a pycnium did not appear to be a prerequisite for telium formation, with many leaves having one stage but no evidence of the other (FIG. 2.7C). Masses of pycniospores were released in a sticky, honey-like fluid through the ostiole of the pycnium (FIG. 2.7D). Shape and size of the pycniospores were variable, subpyriform to ellipsoidal, smooth, 2.8–5.0  $\mu\text{m} \times 1.6$ –2.6  $\mu\text{m}$  (average  $3.8 \pm 0.5 \mu\text{m} \times 2.0 \pm 0.2 \mu\text{m}$ ;  $n = 80$ ) (FIG. 2.7E).

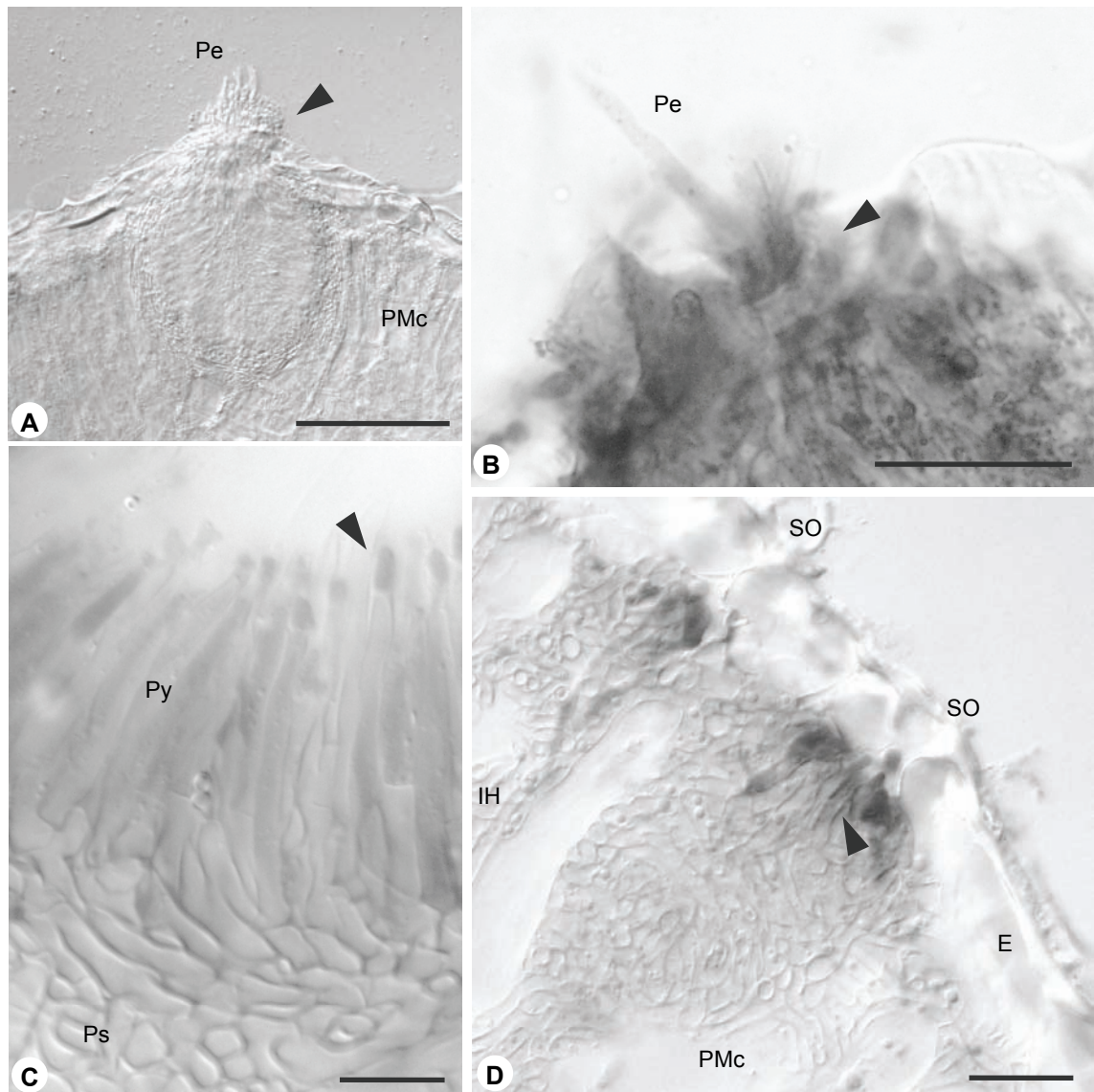
Freehand sections revealed ampulliform, subepidermal pycnia between the epidermis and mesophyll layers of the leaf (FIG. 2.8A). Numerous straight, unbranched, spine-like periphyses (Kirk *et al.* 2001) were present above the hymenium and just below the ostiole, protruding through stomata on the leaf surface (FIG. 2.8B). Accompanying the pointed periphyses were hyphae blunter at the distal end, presumably flexuous hyphae, however morphologically difficult to distinguish from the periphyses with the techniques employed. A layer of pseudoparenchymatous cells lined



**FIG. 2.7.** Pycnial stage of *Puccinia boroniae* on *Boronia megastigma* leaves (specimen M0204).

**A.** Upper and lower *B. megastigma* leaf surface showing masses of pycnia at various stages of maturity. Bar = 0.5 mm; **B.** Close up of pycnial cluster on abaxial leaf surface. Bar = 0.25 mm; **C.** Telium (T) and pycnia (P) on adjacent leaves. Bar = 1.0 mm; **D.** Sticky, honey-like fluid (arrow) being released through the ostiole of the pycnium. Bar = 0.1 mm; **E.** Pycniospores of *P. boroniae* mounted in lactoglycerol cotton blue. Bar = 20  $\mu$ m.

the hymenium of the pycnium, from which long slender pycniosporophores arose (FIG. 2.8C). An extensive network of intercellular hyphae was present within the leaf tissue, extending laterally from pycnia along the mesophyll/epidermal cell layer interface and between the mesophyll cells below. Intracellular hyphae resembling M-haustoria were observed in mesophyll cells adjacent and beneath the pycnia. The cells of the vascular



**FIG. 2.8.** Sections of *Puccinia boroniae* pycnia showing structure of the pycnium and pycnial primordia.

**A.** Pycnium between the epidermal and palisade mesophyll cells (PMc) on the adaxial surface of *B. megastigma* leaf. Note the periphyses (PE) and released pycniospores (arrow). Bar = 100  $\mu\text{m}$ ; **B.** Obliquely sectioned pycnium (top section only) showing the extension of pointed periphyses (Pe) through an intact stomata (arrow). Bar = 10  $\mu\text{m}$ ; **C.** Stained vertical section of a pycnium showing surrounding layer of pseudoparenchymatous cells (Ps) and pycniosporophores (Py) with attached pycniospores (arrow). Bar = 10  $\mu\text{m}$ ; **D.** Two pycnial primordia at different stages of maturity situated between the epidermal (E) and palisade mesophyll cells (PMc). Note directed growth of the periphyses (arrow) towards the stomatal openings (SO) together with the extensive network of intercellular hyphae (IH) between the mesophyll cells and below the epidermal cell layer. Bar = 20  $\mu\text{m}$ .

tissue were not invaded. Densely woven hyphae developing beneath stomata on both leaf surfaces were observed, forming pycnial primordia with growth focused towards the stomatal openings (FIG. 2.8D). As the material examined was from natural infection and not a single basidiospore inoculation, it was impossible to determine whether the multiple pycnia developed from a single infective spore or multiple spores.

## **2.5 Discussion**

This study reports for the first time descriptions of the teliospore germination structures, basidiospore formation and pycnia of *P. boroniae*. Descriptions of the telial stage provided by earlier authors (Hennings 1903; Sydow and Sydow 1904; McAlpine 1906) were confirmed and expanded on. The immediate germination of *P. boroniae* teliospores without a period of dormancy as reported by Hennings (1903) and McAlpine (1906) was also confirmed. Furthermore, the presence of solely the telial and pycnial stage on the same primary host, together with observations of M-haustoria in host tissue infected by these spore stages provides strong evidence for a microcyclic lifecycle.

### **2.5.1 Telial stage**

Telia of *P. boroniae* were predominantly observed on leaves of susceptible *Boronia* spp., mostly scattered in arrangement. Though telia were observed on stems in a number of specimens, extensive confluent formation of telia on the stems as described by Hennings (1903), Sydow (1904) and McAlpine (1906) was restricted to collections from *B. megastigma* hosts at the Mt Barker plantation. As all previous authors examined the same sole collection, the additional plant parts shown to exhibit telia in the present study is most likely due to more extensive specimen examination. The ability of *P. boroniae* to colonize various parts of the plant tissue is seen as advantageous for survival and spread of the pathogen.

Telium structure of *P. boroniae* was typical of many *Puccinia* spp., being subepidermal, erumpent, with a well developed basal layer of sporogenous cells from which teliospores were born singly on pedicles (Cummins and Hiratsuka 1983; Mendgen 1984). Teliospore morphology agrees with previous descriptions, with variations in the septum and pedicle insertion, and cell numbers detailed more extensively. As previous authors measured spores from the same specimen, a combined range of teliospore dimensions was determined as 20–40  $\mu\text{m}$   $\times$  15–21  $\mu\text{m}$ . The data from the present study agrees with those from the previous studies, with a combined range from all specimens being 22–37  $\mu\text{m}$   $\times$  13–20  $\mu\text{m}$ .

Of the previously published descriptions of *P. boroniae*, only Hennings (1906) describes the presence and morphology of mesospores and 3-celled teliospores. The range in mesospore dimensions reported in the present study were far more extensive than those reported by Hennings (1906) (30–34  $\mu\text{m}$   $\times$  17–18  $\mu\text{m}$ ), again a likely result of more extensive specimen examination. Variation in teliospore cell number, as reported for *P. boroniae* in this study, is not uncommon, with examples of cell number variation in cereal rusts cited by Mendgen (1984). The percentages of total spore numbers that comprise of these variants have been reported to vary between isolates (Mendgen 1984), similar to the variation reported herein in the mesospore percentages between different specimens of *P. boroniae*.

### **2.5.2 Intercellular hyphae and haustoria**

Hyphae extended both laterally from and into the area beneath each telium, between and within the mesophyll cells of the host tissue. However it was not seen to enter the vascular tissue cells, indicating a non-systemic mode of infection. Upon entry of hyphae into host mesophyll cells, two different morphological types were observed; simple intracellular hyphae and characteristic M-haustoria (Littlefield 1981; Harder and



Chong 1984). The M-haustoria differed from the intracellular hyphae in being highly branched with a defined neck region at the point of entry into the host cell, and terminating within the infected host cell.

Two morphological types of haustoria are recognized within rust fungi, based on the spore stage responsible for infection; M-haustoria, which are structurally undefined intracellular hyphae, resulting from infection by basidiospores, and dikaryotic haustoria (D-haustoria) which are generally defined structures, often kidney shaped, developing from infection by aeciospores and urediospores (Littlefield 1981; Harder and Chong 1984; Quilliam and Shattock 2003). The observation of M-haustoria in host cells associated with telia of *P. boroniae* suggests that telial formation is a result of a successful basidiospore infection (with or without pycnia production) without the intermediates of aeciospores or urediospores, which were never observed in the field.

### **2.5.3 Teliospore germination and basidiospores**

Teliospores of rust fungi are often subjected to a period of dormancy, with uniform germination often difficult to achieve in the laboratory (Anikster 1986; Staples and Hoch 1997; Staples 2000). However, teliospores of some species are capable of germinating upon maturity without a period of dormancy, referred to as leptospores (Kirk *et al.* 2001). Teliospores of *P. boroniae* were observed to germinated immediately, confirming the description provided by earlier authors (Hennings 1903; Sydow and Sydow 1904; McAlpine 1906).

Consistent and reproducible formation of a single basidiospore from each metabasidium under all experimental conditions indicated this to be the normal behaviour of *P. boroniae*. The formation of a whip-like germ tube instead of a normal basidiospore was only occasionally observed during this study. Several rust species, including *Puccinia patriniae*, *Uromyces aloes* and *Endoraecium acaciae*, have been

reported to form these whiplike germ tubes which then function as infection hyphae (Ono 2002a; Ono 2002b). However, due to rare occurrence of these structures during *P. boroniae* germination, it is believed that their formation was an abnormal germination structure associated with germinating teliospores remaining submerged in excessive water, an observation made by other authors (Gardner 1996; Ono 2002b).

Rust fungi have been shown to possess a large diversity in their basidial development, with Hiratsuka and Sata (1982) outlining 8 different variations of basidial development. The typical cycle represented in many textbooks is a haploid binucleate teliospore undergoing karyogamy and meiosis to germinate and produce four haploid basidiospores on a four celled metabasidium (Littlefield 1981). This type of germination is most often seen in the macro- and demicyclic rust species, though less frequently in microcyclic rust species (Ono 2002a). Microcyclic rust fungi generally show a greater diversity in their germination patterns, with Ono (2002a) presenting a review detailing 9 different types of basidial development with 11 variations among the microcyclic rust species. The formation of a single basidiospore observed for *P. boroniae* in this study, though unusual, has been previously reported for *Puccinia rutainsulara* (Gardner 1994) and *Uromyces alyxiae* (Gardner 1987). The basidiospores themselves were nondescript in size and shape, sharing a common morphology with many other rust basidiospores (Gold and Mendgen 1991).

#### **2.5.4 Pycnial stage**

The pycnial stage of *P. boroniae* was detected on a single host plant species (*B. megastigma*) at one commercial plantation in Mt Barker, Western Australia. The structure of the pycnium conformed to type 4 as describe by Hiratsuka and Cummins (1963), typical of *Puccinia* spp. and characterised by determinate growth, subepidermal and strongly convex hymenia, with well-developed bounding structures (periphyses). Flexuous hyphae were not conclusively identified in the specimens examined with the

techniques employed, though Harder (1984) and Gold *et al.* (1979) report the distinction of flexuous hyphae from periphyses as being less erect and less pointed, as seen in the *P. boroniae* specimens examined in this study. Unlike other *Puccinia* spp., such as *P. recondita* (Gold *et al.* 1979), ostiole formation occurred by the extension of periphyses through stomata rather than rupturing of the leaf epidermis, as reported for *Melampsora lini* (Gold and Littlefield 1979).

Though pycnia were present on the leaves of many *B. megastigma* plants within the Mt Barker plantation, the vast majority of specimens collected at this site exhibited solely telia at varying stages of maturity. No pycnia were observed on any infected stems, despite stems often being heavily infected with the telial stage. Extension of the periphyses and release of the pycniospores solely through stomata would explain the absence of pycnia on the stems. This occurrence also raises questions in regard to the functionality of the pycnial structures, as during periods of stomatal constriction, flexuous hyphae extruding through the stomata would mostly likely be pinched off. Furthermore, no other *P. boroniae* specimens from different plantations within the great southern region of Western Australia exhibited the pycnial stage despite extensive field examination. This would lead to the conclusion that the pycnial stage is not a prerequisite for the development of the telial stage, and though still present, is unlikely to be a functional part of the pathogen's lifecycle. Completion of the lifecycle of these specimens under controlled conditions would aid in confirming the role of the pycnia.

### **2.5.5 Conclusions about the lifecycle of *Puccinia boroniae***

Lifecycles of rust fungi are categorized according to the spore stages produced (Hiratsuka and Sato 1982). For *P. boroniae*, these are limited to the spore stages described herein: the telial stage and restricted observations of the pycnial stage. The occurrence of the pycnial stage on the same host species as the telial stage concludes an autoecious nature, and based on the spore stages produced, a microcyclic lifecycle



(which by default, is autoecious in nature). The presence of M-haustoria associated with the telial and pycnial stage further supports this conclusion.

---

**CHAPTER 3**

**GENETIC VARIATION OF PUCCINIA BORONIAE ASSESSED  
BY PCR-RFLP AND SEQUENCE ANALYSIS OF THE  
NUCLEAR RIBOSOMAL RNA GENES**



Telia of *Puccinia boroniae* on developing flower  
bud of *Boronia* 'Purple Jarad'

**Partially published as:** Driessen SA, Hardy GESTJ, O'Brien PA (2004) Diversity of *Puccinia boroniae* assessed by teliospore morphology and restriction fragment patterns of ribosomal DNA. *Australasian Plant Pathology* **33**, 77–82.

**Submitted manuscript:** Driessen SA, Hardy GESTJ, O'Brien PA. Intraspecific diversity of the rust pathogen *Puccinia boroniae* assessed by PCR-RFLP analysis of the nuclear ribosomal DNA intergenic spacer 2 region. *Mycological Research*.

**Conference proceedings:** Driessen SA, O'Brien PA, Hardy GESTJ (2003) *Puccinia boroniae*: Studies of the telial stage infecting *Boronia* in Western Australia. In Vol.2. *Offered papers of the 8<sup>th</sup> International Congress of Plant Pathology, 2003, Christchurch, New Zealand*.

### 3.1 Chapter Abstract

Variation among 22 field specimens of *Puccinia boroniae* collected from commercial *Boronia* plantations in Western Australia was assessed by polymerase chain reaction (PCR)-restriction fragment length polymorphism (RFLP) of the intergenic spacer 2 (IGS2) region of the nuclear ribosomal RNA genes. Two different RFLP profiles were generated separating three specimens (Group 2), all infecting *Boronia megastigma* at a single plantation collected over three sampling periods, from the remaining sampled population (Group 1) which includes a range of *Boronia* species. A single specimen collected from the same location as the Group 2 specimens, but infecting *B. heterophylla*, produced a Group 1 RFLP profile. Comparison of sequence data generated from representative specimens from each profile group showed that single point mutations at endonuclease recognition sites were responsible for the changes in profile. Variation between single telia of *P. boroniae* collected from individual *B. megastigma* plants at the plantation exhibiting the Group 2 profile was examined by PCR-RFLP analysis of the nuclear internal transcribed spacer (ITS) region. A single homologous profile was observed. Overall, no segregation of *P. boroniae* according to host specificity was concluded, though the data suggested the possible presence of a subspecies (race) of *P. boroniae*, isolated by geographic location and possibly host (cultivar) specificity. The low diversity observed in this study is discussed in light of *P. boroniae*'s lifecycle and the likely influence human distribution has on the pathogen.

### 3.2 Introduction

Diversity within a pathogen population is an important issue to address when devising control methods in agricultural crops. Phenotypic differences expressed in the form of host range, host species and cultivar specificity is both important and traditionally used when investigating rust fungi as pathogen control can often be achieved for (limited) periods of time through appropriate choice of stock planting material. This type of

phenotypic variation is generally established through artificial inoculation of selected groups of host plants (Anikster 1984; Roelfs 1984). However markers based on virulence/avirulence patterns cannot be employed in situations where the virulence interaction between host and pathogen has not been defined (McDermott 1993; McDonald and McDermott 1993), as is the case with *Puccinia boroniae*. The use of DNA (molecular) markers, or electrophoretic markers as described by McDonald and McDermott (1993), overcomes this problem, as well as potentially providing more information regarding the overall diversity of the pathogen population at a genetic level. Molecular markers are now used extensively in examining diversity of fungal plant pathogens (Henson and Fench 1993; Egger 1995; Ennos and McConnell 1995; Bridge and Arora 1998; Edel 1998; Grube and Kroken 2000), with nuclear ribosomal genes frequently targeted.

Studies into the diversity of fungal species have shown that the non-transcribed intergenic spacer (IGS) region of the nuclear ribosomal subunit often provides higher inter- and intraspecific variability than the internal transcribed spacer (ITS) region. The IGS region lies between the 18S and 25S genes and is considered to be the most rapidly evolving region of the rDNA repeat unit (Hillis and Dixon 1991). Polymorphism among races of *Puccinia graminis* f. sp. *tritici* and *Puccinia hordei* has been detected targeting this region (Kim *et al.* 1992; Jennings *et al.* 1997). Similar to the ITS region, the IGS is often separated into two regions (IGS1 and IGS2) by the presence of the more conserved 5S gene coding region in many basidiomycetes (Kim *et al.* 1992; Selosse *et al.* 1996; Gomes *et al.* 1999; Guidot *et al.* 1999; Roose-Amsaleg *et al.* 2002; Sugita *et al.* 2002) as well as some ascomycetes and oomycetes (Liew *et al.* 1998; Ciarmela *et al.* 2002). The presence of this conservative coding region has allowed for the development of PCR primers, amplifying either the IGS1 or IGS2 region selectively.

Previously, the genetic diversity of *P. boroniae* was assessed by PCR-RFLP analysis of the nuclear ribosomal ITS region (Driessen *et al.* 2004), resulting in a single homologous profile among all specimens screened. One specimen showed minor length variation (<30 bp), however as sequence data of the ITS region was not generated during that study, the presence of the enzyme recognition sites and the nature of the length variation were not confirmed. It was concluded that polymorphism within the ITS region was too low to define any intraspecific differences present, and alternative regions or genes with greater divergence were required to further investigate the level of diversity present.

The objectives of this present study were to: (i) confirm the data generated by the previous study by constructing sequence data of the ITS region of *P. boroniae*, (ii) further investigate the level of diversity within the sample population by analysing the IGS region using sequence and PCR-RFLP data, and (iii) analyse the genetic diversity within a single plantation. The possible nature of the variation present and whether the observed variation could be attributed to either host specificity or geographical location is discussed. Furthermore, the possible implication of the data in regard to the pathogen's dispersal between plantations is also addressed.

### **3.3 Material and Methods**

#### **3.3.1 Rust specimen collection and origin**

Twenty-two field specimens of *P. boroniae* telia were collected from seven different host *Boronia* species and cultivars. Eight commercial cutflower plantations were sampled from, extending from Mt Barker through to Albany and Denmark in the great southern region of Western Australia (FIG. 3.1, TABLE 3.1). The majority of specimens used had been collected for a previous study of *P. boroniae* during the period of March–August 2000 (Driessen *et al.* 2004). Sequenced specimens were deposited with the

Western Australian Department of Agriculture Plant Pathogen Collection and the Western Australian Herbarium (TABLE 3.1).

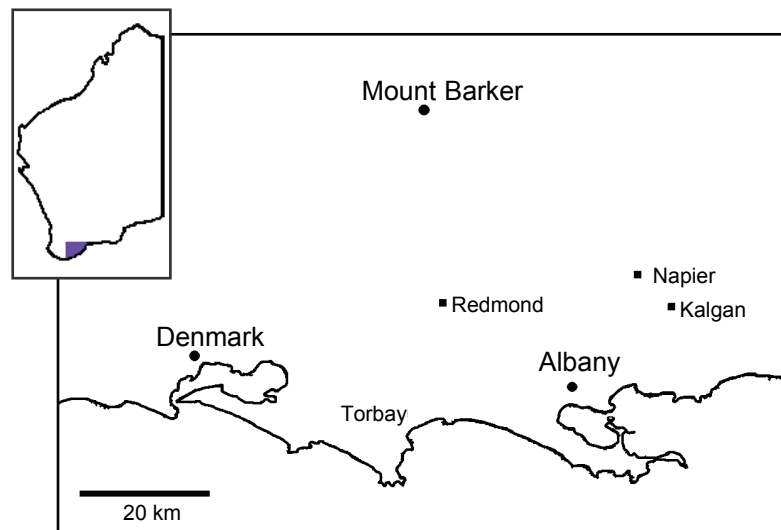


FIG. 3.1. Map of Western Australia highlighting *P. boroniae* specimen collection areas in the great southern region.

TABLE 3.1. Collection details of *Puccinia boroniae* specimens analysed in this study.

<i>Boronia</i> species	Specimen code	Herbarium number <sup>†</sup>	Location* (Western Australia)	Date (mm/yr)
<i>B. carousel</i>	B04	-	Napier (34° 49'S, 118° 0'E)	Jun 00
<i>B. clavata</i>	B06	-	Napier (34° 49'S, 118° 0'E)	Jun 00
	B09	WAC12427	Redmond (34° 54'S, 117° 33'E)	Jun 00
	B13	-	Denmark (34° 55'S, 117° 15'E)	Jul 00
<i>B. heterophylla</i>	H04	-	Albany (1) (34° 99'S, 117° 95'E)	May 00
	H1201A1	-	Albany (1) (34° 99'S, 117° 95'E)	Dec 01
	H0704	WAC12425	Albany (2) (35° 01'S, 117° 50'E)	Jul 04
	H06	-	Kalgan (34° 53'S, 118° 0'E)	May 00
	H07	WAC12429	Mt Barker (34° 34'S, 117° 46'E)	May 00
	H09	-	Napier (34° 49'S, 118° 0'E)	Jun 00
	H10	WAC12428	Redmond (34° 54'S, 117° 33'E)	Jun 00
	H12	-	Torbay (34° 01'S, 117° 39'E)	Jun 00
	H13	-	Denmark (34° 55'S, 117° 20'E)	Jul 00
<i>B. heterophylla</i> 'Morande candy'	B05	-	Napier (34° 49'S, 118° 0'E)	Jun 00
<i>B. heterophylla</i> 'Millbrook'	B10	-	Redmond (34° 54'S, 117° 33'E)	Jun 00
<i>Boronia</i> 'Purple Jarad' ( <i>B. heterophylla</i> × <i>megastigma</i> )	B12	-	Redmond (34° 54'S, 117° 33'E)	Aug 00
	B15	WAC12440	Torbay (34° 01'S, 117° 39'E)	Aug 00
<i>B. megastigma</i>	M04	-	Kalgan (34° 53'S, 118° 0'E)	May 00
	M05	WAC12424	Mt Barker (34° 34'S, 117° 46'E)	May 00
	M1201T1	WAC12430	Mt Barker (34° 34'S, 117° 46'E)	Dec 01
	M0404	-	Mt Barker (34° 34'S, 117° 46'E)	Apr 04
	M07	-	Torbay (34° 01'S, 117° 39'E)	Jun 00

\* Numbers in brackets indicate the site number when more than 1 plantation was sampled from the same region

† PERTH numbers pending

To analyse the variation within a single plantation, single telia specimens of *P. boroniae* were collected in April 2004 from 47 individual stands of *B. megastigma* planted adjacent to each other in a single row at a plantation in Mt Barker, Western Australia. A small quantity (< 100 teliospores) of each telium was removed under a dissecting microscope with a sterile needle and placed into a 0.5 mL microfuge tube containing 5 µL molecular biology grade water. Telia present on both stem and leaf from the same plant were treated as two separate samples. Samples were stored at -20 °C prior to PCR amplification.

### 3.3.2 DNA extraction

Genomic DNA from each specimen was extracted according to the method of Stewart (1997). Telia were not separated from the plant material prior to extraction. Briefly, several leaves and/or plant stem material exhibiting telia from each individual specimen were ground with a motorised plastic pestle in 500 µL extraction buffer (100 mM Tris.HCl pH 8.0, 20 mM EDTA, 2 % CTAB, 1.42 M NaCl, 2 % polyvinylpyrrolidone-40, 5 mM ascorbic acid, 4 mM diethyldithiocarbamic acid - 3 µL β-mercaptoethanol added just prior to use) until a fine slurry was obtained and incubated at 65 °C for 30–60 min. Five hundred microlitres of chloroform:isoamylalcohol (24:1) was added, mixed and centrifuged at 1500 g for 5 min. DNA was precipitated from the aqueous layer with 270 µL isopropanol. The precipitate was collected by centrifugation at 10000 g for 5 min and resuspended in 50 µL molecular biology grade water. A 1:10 dilution of each extraction was used for PCR amplification. The same method was used for extraction of genomic DNA from fresh leaves of uninfected *B. heterophylla*, *B. megastigma* and *Boronia* 'Purple Jarad', and urediospores of *Puccinia hordei* (supplied by Dr Jeremy Burdon, CSIRO Canberra) for use as controls during PCR and RFLP analysis.

### 3.3.3 PCR amplification parameters

#### 3.3.3.1 *ITS region*

A 1290 bp section of the ITS region, encompassing the entire ITS region and a portion of the large ribosomal subunit of five representative specimens (H07, H10, M05, M1201T1 and B15) was amplified by PCR with primers Rust1 and ITS5 (FIG. 3.2A, TABLE 3.2). PCR reactions were completed in 25  $\mu$ L volumes containing 0.5 U Taq polymerase (Fisher Biotec), 2 mM MgCl<sub>2</sub>, 0.5 mM primer (Proligo), 2  $\mu$ L of the diluted DNA extract and 1 $\times$  PCR polymerisation buffer (67 mM Tris-HCl pH 8.8, 16 mM (NH<sub>4</sub>)<sub>2</sub>SO<sub>4</sub>, 0.45 % Triton X-100, 0.2 mg.mL<sup>-1</sup> Gelatin, 0.2 mM dNTPs) (Fisher Biotec). Reactions were executed on a programmable heated lid DNA thermocycler (Hybaid OmniGene) according to the following parameters: 98 °C for 2 min, followed by 35 cycles of 94 °C (30 sec), 55 °C (1 min) and 72 °C (2 min) with a final extension of 72 °C for 10 min. Products were electrophoresed on 0.7 % agarose in Tris-acetate (TAE) buffer (40 mM Tris-acetate, 1 mM EDTA pH 8.0), stained with 0.5  $\mu$ g.mL<sup>-1</sup> Ethidium Bromide (EtBr) and viewed under UV light (Gibco BRL UV transilluminator).

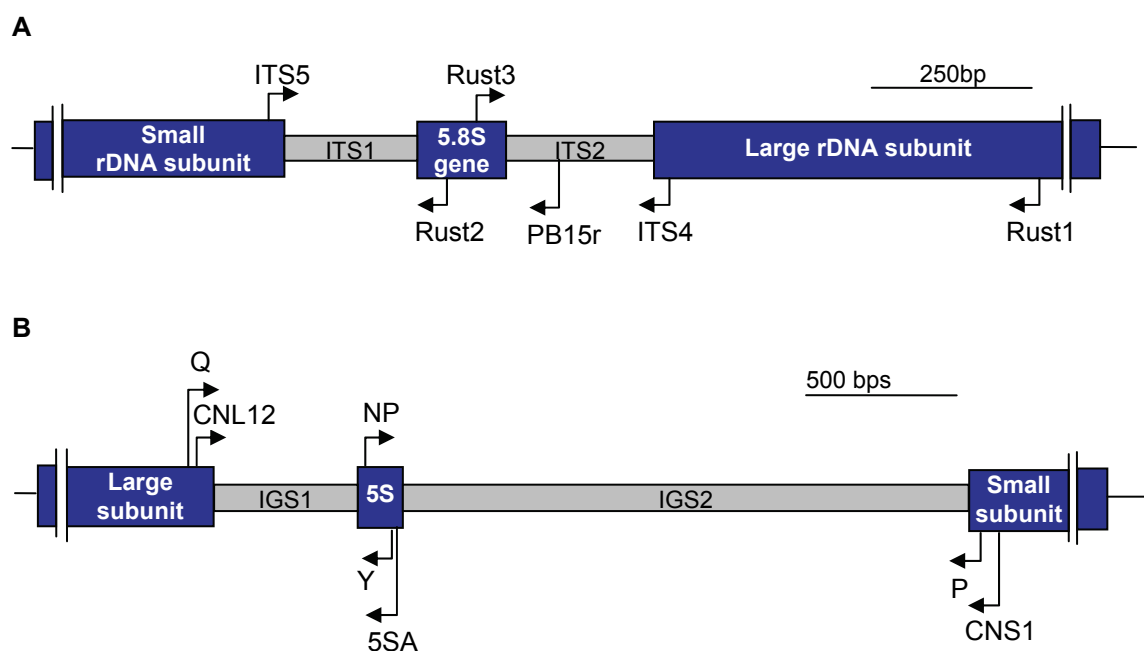
Direct PCR amplification of the ITS region of single telium samples was achieved using a nested PCR protocol. Primary PCR reactions were completed with universal primers ITS4 and ITS5 (FIG. 3.2A, TABLE 3.2) by adding 20  $\mu$ L of a PCR master mix containing 0.5 U Taq polymerase, 1.5 mM MgCl<sub>2</sub>, 0.5 mM primer and 1 $\times$  PCR polymerisation buffer directly to each telium sample stored in H<sub>2</sub>O (SECTION 3.3.1). Amplification parameters were slightly modified, with an initial denaturation of 10 min at 95 °C and the extension time lowered to 1 min at 72 °C. Nested PCR reactions were completed with primers ITS5 and PB15r (FIG. 3.2A, TABLE 3.2), using 5  $\mu$ L of the primary PCR product (diluted 1:10) as template. The PB15r primer was designed using the PRIME program (available through the Australian National Genome Information



Service - ANGIS) and its properties checked using NetPrimer© (PREMIER Biosoft International). Reaction volumes, constituents and thermocycler parameters were as described above, with the initial denaturation time lowered to 5 min. PCR products were analysed on a 1 % agarose gel as described above.

**TABLE 3.2.** Sequence and specificity of PCR primers used in this study for amplification and sequencing of the nuclear ribosomal ITS and IGS regions of *P. boroniae*.

Region	Primer	Sequence (5' – 3')	Reference
ITS	ITS4	TCC TCC GCT TAT TGA TAT GC	White <i>et al.</i> 1990
	ITS5	GGA AGT AAA AGT CTGT AAC AAG G	White <i>et al.</i> 1990
	Rust1	GCT TAC TGC CTT CCT CAA TC	Liu <i>et al.</i> 1993; Kropp <i>et al.</i> 1997
	Rust2	TTT CAC TGT GTT CTT CAT C	Kropp <i>et al.</i> 1997
	Rust3	GAA TCT TTG AAC GCA CCT TG	Kropp <i>et al.</i> 1997
	PB15r	CTA ATC ACA GCA ACA CTC AAC	This study
IGS	Q	ACG CCT CTA AGT CAG AAT	Fox <i>et al.</i> 1995
	Y	TCG CAG AGC GAA CGG GAT	Fox <i>et al.</i> 1995
	NP	ATC TGG GGG CAT ACC AC	Fox <i>et al.</i> 1995
	P	GGC TCC CTC TCC GGA ATC	Fox <i>et al.</i> 1995
	CNL12	CTG AAC GCC TCT AAG TCA G	Anderson and Stasovski 1992
	CNS1	GAG ACA AGC ATA TGA CTA CTG	Anderson and Stasovski 1992
	5SA	CAG AGT CCT ATG GCC GTG GAT	Anderson and Stasovski 1992



**FIG. 3.2.** Diagrammatic representation of the nuclear ribosomal ITS (A) and IGS (B) regions of *Puccinia boroniae*, highlighting the binding sites of the primers detailed in TABLE 3.2.

### 3.3.3.2 IGS region

Several combinations of primers were screened for selective amplification of the entire *P. boroniae* IGS region or segments of it (FIG. 3.2B, TABLE 3.2). PCR reactions were carried out in 10  $\mu$ L reaction volumes containing 0.5 U Taq polymerase, 2 mM MgCl<sub>2</sub>, 0.5 mM of each primer, 1  $\mu$ L of a 1:10 diluted DNA template and 1 $\times$  PCR polymerisation buffer. Each primer combination was screened against 3 *P. boroniae* specimens, *B. heterophylla* (negative plant control) and *P. hordei* (positive rust control). Cycling parameters were initial denaturation at 94 °C for 5 min, followed by 30 cycles of 94 °C (1 min), 50 °C (1 min) and 72 °C (3 min), with a final extension at 72 °C for 10 min. PCR products were separated by gel electrophoresis on a 1 % agarose as described above (SECTION 3.3.3.1).

Following preliminary screening, the IGS2 region of specimens H07, H10, M05, M1201T1 and B15 was amplified with primers CNS1 and NP in 50  $\mu$ L reaction volumes containing 1.5 U Taq polymerase, 1.5 mM MgCl<sub>2</sub>, 0.5 mM primers, 4  $\mu$ L of a 1:10 diluted DNA extract and 1 $\times$  polymerisation buffer. PCR cycling parameters were as detailed above, with the annealing temperature modified to 55 °C for 1 min. Twenty microliters of each PCR product was electrophoresed on a 2 % agarose gel stained and visualized as described above.

### 3.3.4 Cloning and sequencing

The resulting ITS and IGS2 fragment (amplified with primers Rust1/ITS5 and CNS1/NP respectively) from each *P. boroniae* specimen screened was extracted and purified from the agarose gel using the QIAquick Gel Extraction Kit (Qiagen). Each fragment was ligated into either pGEM®T vector (Promega) or pCII-TOPO vector (Invitrogen) according to the manufacturer's recommendations and transformed into competent *E. coli* cells provided by the manufacturer. A smaller fragment of the ITS

region of specimen M05, extending between primer binding sites ITS4 and ITS5 (FIG. 3.2A) was cloned by initially completing a nested PCR reaction with primers ITS4/ITS5 according to the method detailed above, using the gel extracted Rust1/ITS5 PCR product as the template. This was completed as no positive clones were obtained by ligation of the larger fragment into the vector. Several recombinant clones from each specimen were inoculated separately in 10 mL Luria-Bertani broth containing 50  $\mu\text{g}\cdot\text{mL}^{-1}$  ampicillin and incubated overnight at 37 °C on a horizontal shaker (225 rpm). Plasmid DNA was extracted from 3–5 mL of culture by either alkaline denaturation of the bacterial solution (Sambrook *et al.* 1989) or with QIAprep spin columns (Qiagen).

The insert of each clone was sequenced with the original PCR primers, primers that bound within the vector sequence (T7, SP6, M13 forward and reverse) or a combination of both dependant on the vector used and the nature of the insert (ITS or IGS2). Based on initial sequence data of the IGS2 region, internal primers IG2f49 (5'-TTG AAG TTG GTT GGT GAG-3') and IG2r92 (5'-AGA ACA AGA CTT TTT GGG ACA G-3') (Proligo), binding approximately 400–500 bps internal to the 5' and 3' end of the IGS2 region respectively, were constructed with the PRIME program (ANGIS) in order to obtain the full sequence. Standard half reactions were completed, composing of 4  $\mu\text{L}$  ABI PRISM® BigDye Terminator Ready Reaction Cycle Sequencing Kit mix (version 3 or 3.1) (Applied Biosystems), 1.6 pmoles primer (3.2 pmoles for version 3.1), 150–300 ng plasmid DNA and made up to a final volume of 10  $\mu\text{L}$  with H<sub>2</sub>O. Sequencing reactions were completed in a heated lid thermocycler programmed as follows: 96 °C for 4 min, followed by 25 cycles of 96 °C (10 sec), 50–55°C (5 sec) and 60 °C (4 min). Post-sequence reactions were purified by ethanol precipitation according to Applied Biosystems recommendation. Purified samples were submitted to the Western Australian State Agricultural Biotechnology Centre (SABC)

for sequencing, completed on an ABI373XL automated sequencer (Applied Biosystems).

Sequence editing and consensus sequence formation was completed using the program SeqEd (v1.04, PE Applied Biosystems, Foster City, California). Restriction site determination and multiple sequence alignments were completed using Mapplot and EclustlW programs (ANGIS) and adjusted manually with Bioedit© version 7.0.0 (Tom Hall, Isis Pharmaceuticals Inc.) (Hall 1999). The sequence of each clone was deposited with Genbank, accession numbers AY190298–AY190301, AY348707–AY348716 (ITS region) and AY348693–AY348706 (IGS2 region).

### 3.3.5 Restriction digestions of the ITS and IGS2 regions

In separate reactions, the PCR product of the IGS2 region of all 22 *P. boroniae* specimens (TABLE 3.1) and the outgroup *P. hordei* was digested with *AluI*, *HpaII*, *TaqI*, *EcoRI*, *Nsi* and *DraI* (Promega, Australia). The nested PCR product of the ITS region of the single *P. boroniae* telium specimens was digested with *TaqI*. Restriction digests were completed in 10  $\mu$ L reaction volumes, containing 5  $\mu$ L unpurified PCR product, 5–10 U restriction enzyme, 0.1  $\mu$ g bovine serum albumin (Promega) and made up to the final volume with 1 $\times$  buffer provided by the manufacturer. Digests were carried out for at least 4 h (generally overnight) at the recommended temperature.

Three microlitres of 10 $\times$  Orange G loading buffer [0.5 % w/v Orange G (Sigma, Australia), 50 % w/v sucrose, 10 mM Tris-HCl pH 8.0] was added to each completed digest and fragments were separated by electrophoresis on 2.5 % composite agarose [1.25 % NuSeive agarose 3:1 (Cambridge Bioproducts) and 1.25 % standard agarose] in 1 $\times$  Tris-borate-EDTA (TBE) buffer (89 mM Tris-borate, 2 mM EDTA pH 8.3). Gel images were digitally captured under UV light (EDAS 120, Kodak Digital Science™) after staining with 0.5  $\mu$ g.ml<sup>-1</sup> EtBr and fragment sizes determined by comparison to

molecular weight standards ( $\lambda$  DNA / *Eco*R1 & *Hind*III, and pUC 19 DNA / *Hpa*II, - Fisher Biotech) using Kodak Digital Science™ ID (v 3.0.2) software.

## **3.4 Results**

### **3.4.1 ITS region analysis**

Recognition sites within the ITS region of the enzymes used in the previous study were confirmed for all 5 specimens sequenced, though only three cut within the more variable ITS1 and ITS2 regions. The sequence data showed two *Taq*I recognition sites, a restriction enzyme not included in the original analysis, which would have separated two out of the five specimens examined (FIG. 3.3). Comparison of the ITS sequence length and the PCR product length produced with primers Rust1/ITS5 indicated that the Rust1 primer bound approximately 660 bp upstream of the 5' end of the large rRNA gene.

Alignment of the consensus sequence for H07, H10 and B15 showed 100 % identity (FIG. 3.3). Specimens M05 and M1201T1, collected from *B. megastigma* at the same plantation, showed minor sequence variations when aligned with the other three specimens (FIG. 3.3). Five nucleotide differences were present, evenly spread among the ITS region including a single point mutation within the 5.8S rDNA coding region. These differences were not present in the *B. heterophylla* specimen H07, collected from the same plantation as specimens M05 and M1201T1. Within the ITS1 and ITS2 regions of all specimens were tandem repeats of AT, present in greater numbers in specimens M05 and M1201T1. These insertions, together with the differences in the number of nucleotides in two homopolymeric tracts of T and A residues within the ITS2 region, were likely to be the cause of the reported length variation in these specimens.

Specimen	ITS1							bp
B15	ATTAAAAGAA	TTAGAGTGCA	CTTTATTGTG	GCTTGACCCC	TTTAAATAT	ATCACCCAAA	CTTTTTTTTA	70
H10	-----	-----	-----	-----	-----	-----	-----	70
H07	-----	-----	-----	-----	-----	-----	-----	70
M1201T1	-----	-----	-----	-C-	-----	-----	-----	70
M05	-----	-----	-----	-C-	-----	-----	-----	70
B15	AGACTTGGTT	GCATGGCCCT	GTGTCATTGC	AATTGAGTAA	AAGTAACTTC	TTAATTGATT	GTTACATTAC	140
H10	-----	-----	-----	-----	-----	-----	-----	140
H07	-----	-----	-----	-----	-----	-----	-----	140
M1201T1	-----	-----	-----	-----	-----	-----A-	-----	140
M05	-----	-----	-----	-----	-----	-----A-	-----	140
B15	CCCCCTTTTT	TTTTATATAT	ATATATAT~	~~~~TTATAT	AATAATATAC	ACAAGTTTAA	ATGAATGTAA	204
H10	-----	-----	-----	-----	-----	-----	-----	204
H07	-----	-----	-----	-----	-----	-----	-----	204
M1201T1	-----	-----	-----A-	-----AT	ATAT-----	-----	-----	210
M05	-----	-----	-----AT	ATAT-----	-----	-----	-----	210
		ITS1	5.8S rDNA					
B15	AAAACCCCTT	TAATATAAAA	ATAACTTTTA	ACAATGGATC	TCTAGGCTCT	CACATCGATG	AAGAACACAG	274
H10	-----	-----	-----	-----	-----	-----	-----	274
H07	-----	-----	-----	-----	-----	-----	-----	274
M1201T1	-----	-----	-----	-----	-----	-----	-----	280
M05	-----	-----	-----	-----	-----	-----	-----	280
B15	TGAAATGTGA	TAAGTAATGT	GAATTGCAGA	ATTCAGTGAA	TCATCGAATC	TTTGAACGCA	TCTTGCACCT	344
H10	-----	-----	-----	-----	-----	-----	-----	344
H07	-----	-----	-----	-----	-----	-----	-----	344
M1201T1	-----	-----	-----	-----	-----T-----	-----	-----	350
M05	-----	-----	-----	-----	-----T-----	-----	-----	350
			5.8S rDNA	ITS2				
B15	TTTGGTATTC	CAAAAGGTAC	ACCTGTTTGA	GTGTCATGAA	ACCCTCTCAC	AAAATAATTT	ATTAATTATT	414
H10	-----	-----	-----	-----	-----	-----	-----	414
H07	-----	-----	-----	-----	-----	-----	-----	414
M1201T1	-----	-----	-----	-----	-----	-----	-----	420
M05	-----	-----	-----	-----	-----	-----	-----	420
B15	CTTTTTT~AA	ATTATTATTT	AGTGGAT	GTT	GAGTGTGCT	GIGATTAG	CT	483
H10	-----	-----	-----	-----	-----	-----	-----	483
H07	-----	-----	-----	-----	-----	-----	-----	483
M1201T1	T-----T--	-----	-----	-----	-----	-----	-----	490
M05	T-----T--	-----	-----	-----	-----	-----	-----	490
B15	CTTTTCTGA	ATTAGCTGGA	TTGACTTGGT	GTAATAATCT	CTTAATCATC	ACATCAAGGA	AAGTAGTGAT	553
H10	-----	-----	-----	-----	-----	-----	-----	553
H07	-----	-----	-----	-----	-----	-----	-----	553
M1201T1	-----	-----	-----	-----	-----C-----	-----	-----	560
M05	-----	-----	-----	-----	-----C-----	-----	-----	560
B15	ACTTGCCAGC	TTTTTTATTT	TGAAAGGGAG	ACTTCTAAAA	AAAAA~~~~	~~~~~	~~~~~TATAT	603
H10	-----	-----	-----	-----	-----	-----	-----	603
H07	-----	-----	-----	-----	-----	-----	-----	603
M1201T1	-----	-----	-----	-----	-----AAAAA	A~TT~~~~AT	ATATA-----	625
M05	-----	-----	-----	-----	-----AAAAA	AATTATATAT	ATATA-----	630
		ITS2						
B15	ATATATTTAA	GACCTCAAAT	523					
H10	-----	-----	623					
H07	-----	-----	623					
M1201T1	-----	-----	645					
M05	-----	-----	650					

**FIG. 3.3.** Alignment of *Puccinia boroniae* ITS sequences highlighting nucleotide differences among the five specimens. ~ indicate gap insertion. Underlined nucleotides indicate the binding site for PCR primer PB15r. Grey shaded nucleotides indicate *TaqI* recognition sites.

### 3.4.1.1 Analysis of *Puccinia boroniae* diversity within the Mt Barker plantation

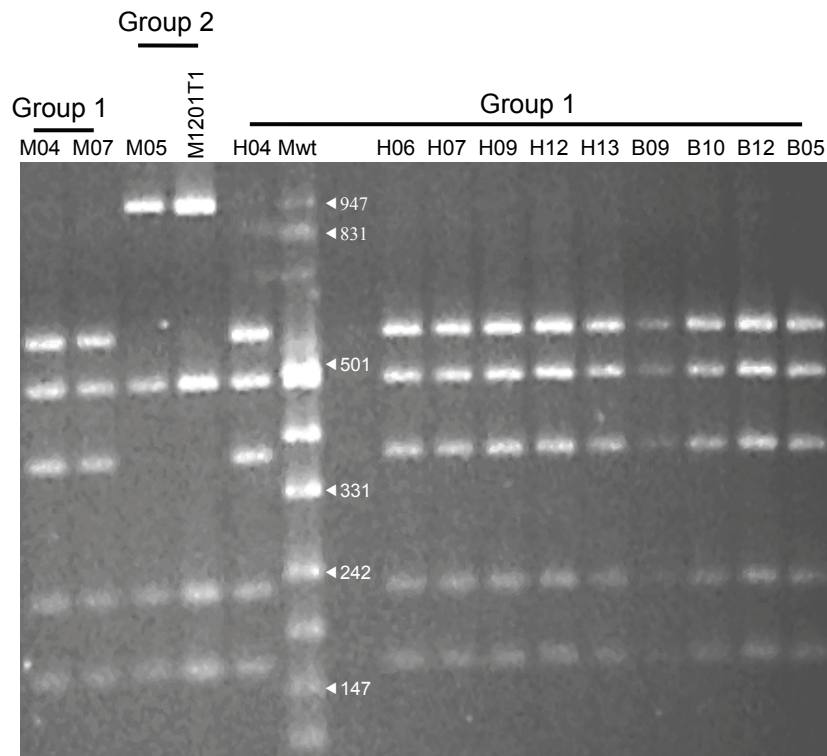
A total of 43 leaf telia and 16 stem telia were analysed by PCR-RFLP of the ITS region. The *TaqI* restriction enzyme was used as sequencing data indicated that a point mutation, resulting in a change in restriction site recognition was present within the Mt Barker specimens and not the other *P. boroniae* specimens (FIG 3.3). Nested PCR reactions produced a single product of approximately 520 bp. Digestion of the PCR product resulted in a homologous profile among all screened telia samples, with three fragments produced (approximately 230, 200 and 88 bp in length). These fragments corresponded in size to the expected sizes by comparison of the sequence data for *P. boroniae* at this location.

## 3.4.2 IGS2 region analysis

From all of the primer pairs tested, CNS1/NP consistently and selectively amplified the *P. boroniae* IGS2 region present within the mixed plant/rust DNA extracts, producing a single band of approximately 2000 bp. *P. hordei*, used as an out-group for RFLP analysis, produced a single band of approximately 2500 bp. No length differences in the amplified IGS2 region were observed among the *P. boroniae* specimens.

### 3.4.2.1 RFLP analysis

Enzymatic digestion of the IGS2 region with *AluI* (FIG. 3.4), *HpaII* and *TaqI* revealed 2 different RFLP profiles, termed Group 1 and Group 2. Specimens M05, M1201T1 and M0404T1 (Group 2) showed one less *AluI* recognition site and an extra *HpaII* and *TaqI* recognition site in comparison to the remaining 19 specimens (Group 1). Identical profiles among all 22 specimens were generated with *NsiI*, *DraI* and *HaeIII* indicating these recognition sites were conserved. Digestion of the outgroup *P hordei* produced a different restriction profile for each enzyme screened, indicating clear species differentiation of the region and method.



**FIG. 3.4.** *Puccinia boroniae* IGS2 region digested with *AluI* showing differences in profile between Group 1 and Group 2 specimens. Lane titles = *P. boroniae* specimen; Mwt = Molecular weight marker (bp).

The absence of length variation observed in the undigested IGS2 PCR product of *P. boroniae* was confirmed after enzymatic digestion. Except for *DraI*, *AluI* and *HaeIII*, combined fragment sizes for each enzymatic digestion equalled that of the undigested PCR product. Discrepancies in fragments lengths of the mentioned enzymes was attributed to co-migrating fragments and smaller fragments (< 100bp) being poorly visible after staining, and was confirmed by comparison with the sequence data.

#### 3.4.2.2 *IGS2* sequence analysis

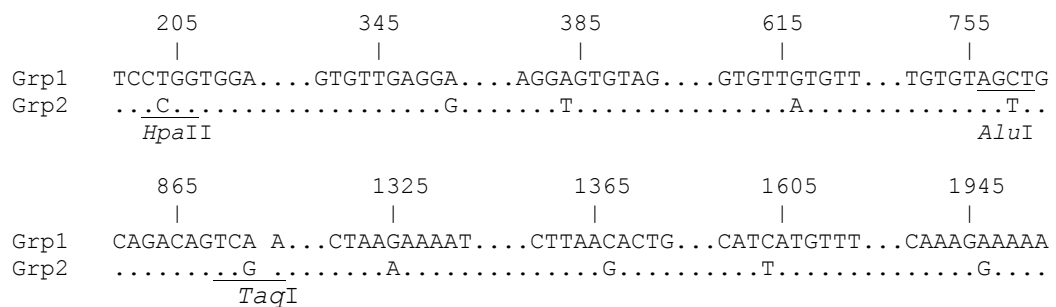
The IGS2 region of the five sequenced *P. boroniae* specimens, including partial segments of the 5S and 18S coding regions, showed minimal length variation, ranging from 1981 to 1987 bp. This was consistent with the size uniformity seen in the original PCR products and in the restriction profiles. Sequences were compared to other fungi



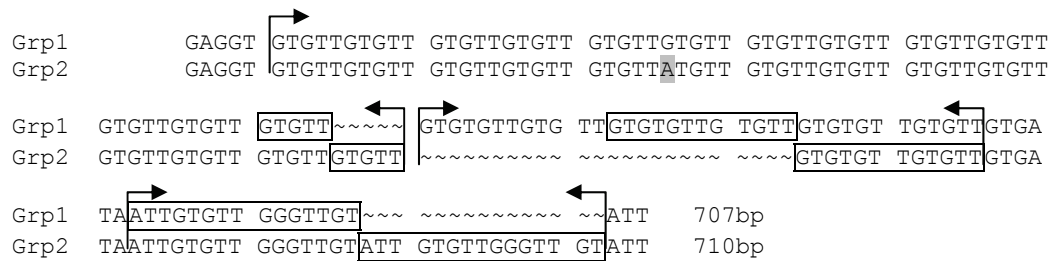
on Genbank using the BLAST search program (version 2.2.7). There were significant alignments with a number of basidiomycete and ascomycete fungi only in the first 118 bases (5S ribosomal RNA gene) and last 40 bases (18S ribosomal RNA gene). This confirmed that the amplified product was from the ribosomal region of *P. boroniae* and not the host *Boronia* DNA.

As seen in the ITS region previously, sequence alignment of the IGS2 region separated the five specimens into two groups, reflecting the grouping seen in the RFLP analysis. Sequences from H07, H10 and B15 (Group 1) were highly conserved, differing solely with a single base deletion in the homopolymeric tract of T residues starting at nucleotide 217 in specimen B15 and an AT deletion in specimen H10 at base 129. Similarly, Group 2 sequences (M05, M1201T1 and M0404T1) were highly conserved, differing by a single T in the homopolymeric tract of T residues starting at nucleotide 217. Between Group 1 and Group 2 sequences, 10 nucleotide substitutions were detected, three of which were responsible for the gain or loss of a recognition site of the endonucleases reported earlier (FIG. 3.5).

Manual correction of the EclustlW alignment at the proximal (5S) end (FIG. 3.6) clarified what initially appeared to be multiple nucleotide substitutions, highlighting a



**FIG. 3.5.** Extracted segments of the alignment of the IGS2 sequences from *Puccinia boroniae* Group 1 (Grp1) and Group 2 (Grp2) specimens. Nucleotide substitutions between the groups and the restriction endonucleases affected are highlighted. Enzyme recognition sites are underlined.



**FIG. 3.6.** Manual alignment of the portion of *Puccinia boroniae* IGS2 consensus sequences from Group1 (Grp1) and Group2 (Grp2) highlighting the sub repeat regions (box) and possible insertion/deletion events (~) of these repeats. Grey shaded nucleotide indicates a base substitution disrupting the tandem repeats. Arrows indicate the span of tandem repeats.

highly repetitive region spanning 118 bp. This region was characterised by three sub-repeated sequences,  $(GT)_2T$ ,  $(GT)_3T(GT)_2T$  and  $AT_2(GT)_2TG_3T_2GT$ , lying either in tandem or distributed between non-repetitive DNA (FIG. 3.6). Insertions and deletions of these sub-repeated sequences accounted for the sequence variation between the two groups.

### 3.5 Discussion

The aim of this research was to study the genetic diversity of the rust pathogen *P. boroniae* using the nuclear ribosomal IGS2 region as a target sequence, and to further analyse the length variation previously reported in the ITS region of *P. boroniae* (Driessen *et al.* 2004). Despite the number of divergent host species/varieties and the geographical distribution of the field specimens examined, polymorphism in both the ITS and IGS2 regions of *P. boroniae* was shown to be low. The minor length heterogeneity within the ITS region reported previously was concluded to be a result of variation in the number of tandem AT repeats present within the ITS region of this specimen.

In contrast to other studies of fungal pathogens (Sugita *et al.* 2002; Yli-Mattila *et al.* 2002; De Arruda *et al.* 2003), the IGS2 region of *P. boroniae* did not show a greater

level of polymorphism than the ITS region. Proportional to the total length of each region analysed, the number of nucleotide substitutions, insertions and sub-repeated elements between the two ribosomal regions were similar. A low level of intraspecific nucleotide variation was observed, with only 5 and 10 nucleotide substitutions present within the ITS and IGS2 regions respectively, more or less evenly spread along the length of the sequenced region.

The IGS2 region of *P. boroniae* exhibited no pronounced length heterogeneity unlike that reported for other fungal IGS1 and/or IGS2 regions (Henrion *et al.* 1992; Pecchia *et al.* 1998; Pramateftaki *et al.* 2000; Mahuku and Platt 2002; Mishra *et al.* 2002; Roose-Amsaleg *et al.* 2002; Sugimoto *et al.* 2003). Length heterogeneity within the fungal IGS region(s) is reported to occur due to insertion/deletion events of sub-repeated sequences present within the non-coding region (Mortin *et al.* 1995; Pantou *et al.* 2003). Although several insertion/deletions events of short sub-repeated DNA sequences within the IGS2 region of *P. boroniae* were observed, these did not result in significant length variation of the region or contribute to the restriction profile variation seen.

Comparison of the restriction profile with the sequence data in the IGS2 region showed that single point mutations at enzyme recognition sites played a critical role in changing the RFLP profiles. The successful amplification of the IGS2 region of all *P. boroniae* specimens with primer NP, which is anchored in the 5S rDNA (Fox *et al.* 1995), confirmed the presence and orientation of the 5S gene within the IGS region as reported for other Basidiomycetes (Kim *et al.* 1992; Morrica *et al.* 1996; Jennings *et al.* 1997; Roose-Amsaleg *et al.* 2002).

Overall the variation present did not correlate with either host species or geographical location. Though both the ITS and IGS2 regions separated the screened population into two groups, the variant group (Group 2) comprised solely of

*P. boroniae* specimens collected from the same *Boronia* species (*B. megastigma*) at one location, separated by a sampling period of 23 months. The two other *P. boroniae* specimens collected from *B. megastigma* at different plantations were shown to be of a Group 1 profile by RFLP analysis of the IGS2 region. However, within the Mt Barker plantation, another specimen (H07) collected at the same time as specimen M05 but from a different host species (*B. heterophylla*) produced a Group 1 profile in both the ITS and IGS2 region. Though this indicated the possible presence of two genetically different types of *P. boroniae* present at the time of sampling, due to the removal of all *B. heterophylla* plants from this plantation shortly after collection, further comparative analysis was unable to be conducted. Examination of the diversity within the plantation by analysis of single telia present on the infected *B. megastigma* plants in 2004 produced a single homologous PCR-RFLP profile, matching that of the Group 2 type.

Genotypic variation may be introduced into fungal populations by a number of means: random mutations, gene flow or recombination (McDermott 1993; Burdon and Silk 1997). Random point mutations account for part of the variation seen in both the ITS and IGS2 regions of *P. boroniae*, but do not explain the insertion/deletion events present in the IGS region. As *P. boroniae* has a microcyclic lifecycle (CHAPTER 6), gene flow would be unlikely to have any major role in the diversity of the pathogen, due to the limited geographical dispersal ability of the infective basidiospores. However, by taking into account the presence of the pycnial stage located at the Group 2 plantation (CHAPTER 2 AND 4) as well as that meiosis is likely to be occurring during teliospore germination (CHAPTER 6), it is possible that the variation has come about through sexual recombination. However, this is as yet speculative, as the functional role of the pycnial stage is inconclusive.

The markers used during this study were from non-coding regions of *P. boroniae*, with variation in a coding region limited to a single base change in the 5.8S gene. As

phenotypic differences between the two groups, in the form of host specificity, has not been determined, the variation present cannot be correlated with any phenotypic variation. However, together with additional observational evidence, such as the lack of infection on susceptible trap plants located at this plantation and the presence of a pycnial stage, it is suggested that these specimens may represent a subspecies of *P. boroniae* and further work is warranted. It is suggested that inoculation trials of the Group 2 *P. boroniae* specimens be completed on a number of different *Boronia* hosts, including the exact cultivar of *B. megastigma* planted out at this location. Furthermore, a multilocus approach to analysis of the genetic variation in *P. boroniae*, incorporating alternative non-linked gene regions such as the elongation factor,  $\beta$ -tubulin (Liyanage *et al.* 1992; Aoki *et al.* 2001; Ayliffe *et al.* 2001; Jong *et al.* 2001; Kwon *et al.* 2001) or histone genes (Jimenez Gasco *et al.* 2002; Talhinhos *et al.* 2002) which have been used successfully with other fungal species, should be examined. A relatively small number of specimens were examined during this study, primarily due to the limited number of *Boronia* growers present in Western Australia. It is also suggested specimens from a larger geographical area, including both bush and commercial stands of *Boronia* from Western Australia and interstate locations, should be incorporated into future molecular studies into the diversity of the population.

The homology present within the remaining population screened (Group 1), raises concerns about the movement of the pathogen within the region. As indicated earlier, *P. boroniae* reproduces through basidiospores, with long distance dispersal of viable rust basidiospores known to be significantly lower than that of the asexual urediospores or aeciospores of rust fungi (Littlefield 1981). For this reason, two different methods of pathogen dispersal are suggested to account for the overall genetic homology seen in the Group 1 *P. boroniae*: (i) short distance dispersal of basidiospores to close neighbouring plantations under optimal transporting (environmental) conditions, and (ii) the

movement of asymptomatic infected plant material/cuttings between plantations and nurseries within the region. It is more likely that the second suggestion is playing a major role, as infected plants may remain asymptomatic for at least 2–3 weeks (CHAPTER 6) before telia become visible. As most growers either obtain their stock material from neighbouring plantations or from a limited number of commercial sources, this time frame allows for the successful exchange of infected planting material to occur, thereby spreading the pathogen through the region in Western Australia.

### **3.5.1 Conclusions**

This study indicates that there is a genetic closeness of all field specimens collected from the sample area in Western Australia, confirming data previously presented on the variability of *P. boroniae*. It is suggested that detailed analysis of the host specificity of the two groups of *P. boroniae* resulting from this study be completed in order to provide more evidence supporting the presence of a subspecies.

---

**CHAPTER 4**

**INCIDENCE OF AIRBORNE BASIDIOSPORES OF *PUCCINIA*  
*BORONIAE* AND THEIR RELATIONSHIP TO WEATHER  
PARAMETERS UNDER FIELD CONDITIONS.**



Split-type volumetric spore trap set adjacent to trial plants  
located at Mt Barker (WA).

**Submitted manuscript:** Driessen SA, O'Brien PA, Hardy GESJ. Airborne basidiospores of *Puccinia boroniae*: Relationship of weather parameters to incidence and detection by DNA analysis. *Australasian Plant Pathology*.

## 4.1 Chapter Abstract

A slit-type volumetric spore trap and trap plants of three rust susceptible *Boronia* spp. were established at a commercial *Boronia* plantation in Mt Barker, Western Australia between August 2003 and September 2004. The trap plants remained uninfected for the duration of the field trial, despite the adjacent commercial stands of *Boronia megastigma* becoming heavily infected between January and September 2004 with telia of *Puccinia boroniae*. Airborne basidiospores morphologically resembling those of *P. boroniae* were captured above the trap plants between January and August 2004, peaking in number and daily occurrence in April 2004 (autumn). Rust-like urediospores or aeciospores were not observed on the spore matrix, consistent with the absence of uredia or aecia on infected hosts. Daily basidiospore numbers were significantly ( $p < 0.01$ ) correlated with minimum temperature and total daily rainfall. Five high basidiospore counts days ( $> 100$  basidiospores) were analysed on an hourly basis. A diurnal periodicity of basidiospore release was observed, peaking on average between 02:00 and 05:00 hrs. Hourly basidiospore numbers were significantly ( $p < 0.01$ ) correlated with the 6 h running averages (preceding spore capture) of relative humidity, air temperature, solar radiation and evaporation, and with the 12 h running average of rainfall. Amplifiable DNA was extracted from a selection of daily spore matrix samples. *P. boroniae* DNA was detected by nested PCR-RFLP analysis of the ITS region in 52 % of samples where basidiospores were seen microscopically.

## 4.2 Introduction

Environmental factors have long been recognised for their leading role in the successful development of disease epidemics in agriculture (Waggoner and Aylor 2000; Agrios 2005). Information regarding the progression of disease in agricultural crops is generally achieved through measurement of disease incidence and severity over time by monitoring the crop (Seem 1984; Kranz 1988). Understanding the relationship between



disease incidence/severity and environmental factors may aid in improving fungicide application timing (Sutton 1978; Edwards *et al.* 1999d; Carisse and Philion 2002).

The occurrence and dispersal of pathogen inoculum and the relationship between climatic conditions is also an important consideration in the dissemination of disease (Meredith 1973; McCartney and Fitt 1998; Campbell 1999; Agrios 2005). Within the rust fungi there are three infective spore stages: urediospores, aeciospores and basidiospores. All three spore forms are wind dispersed. In contrast to airborne urediospores of rust species, which are able to survive transport over large geographical distances (Nagarajan and Singh 1990), viable basidiospores are more confined in their airborne distribution (Littlefield 1981). This is primarily due to their fragility and lack of protective pigmentation, making them prone to desiccation through UV exposure. For these reasons, they are also generally released periodically during periods of darkness (Gold and Littlefield 1979; Mendgen 1984). Studies of the dispersal of basidiospores of many basidiomycetes are present in the literature (Levetin 1990; Levetin 1991; Craig and Levetin 2000), though few make reference to the basidiospores of microcyclic rust fungi, possibly due to the difficulties associated with correctly identifying these spores.

Spore samplers are effective tools in the analysis of inoculum dispersal within agricultural crops. Many different types of spore samplers are available (Levetin 2004), with Hirst-type volumetric air samplers (Hirst 1952) most commonly used in agricultural situations. As airborne fungal spores are often difficult to identify morphologically, with considerable expertise required (Sterling *et al.* 1999), researchers are now turning towards molecular techniques, such as the polymerase chain reaction (PCR) in conjunction with species-specific primers, to identify airborne spores (MacNeil *et al.* 1995; McCartney 2002). These DNA based methods would find particular application in the identification of the hyaline, often morphologically

indistinct basidiospores formed by microcyclic rust species, though to the best knowledge of the author, no currently available literature reports this application.

Despite the impact of *Puccinia boroniae* on the *Boronia* cutflower industry both currently and historically, the vast majority of available information regarding the pathogens disease cycle and development within the crop is based solely on anecdotal evidence. Currently the fungicides propiconazole (Tilt®) and mancozeb (Mancozeb®) are applied for control, generally upon first signs of telia developing. Growers whom spray prophylactically generally achieve a greater level of disease control, although full control is rarely realised. Directed chemical application based on knowledge of the environmental conditions conducive for infection would be an aid in more effective management.

The objectives of this study were to examine the lifecycle of *P. boroniae* and the environmental conditions conducive for the dispersal of inoculum and disease development by: (i) determining the spore stages of the pathogen present during the lifecycle under natural conditions, (ii) investigate the incidence and severity of disease caused by *P. boroniae*, and the relationship to climatic conditions, (iii) investigate the release of the airborne inoculum (basidiospores) of *P. boroniae* under field conditions and investigate the relationships between spore release and weather factors, and (iv) confirm the capture of airborne *P. boroniae* basidiospores with the spore sampler by PCR-restriction fragment length polymorphism (RFLP) analysis of DNA extracted from the spore tape.

### **4.3 Materials and Methods**

#### **4.3.1 Trap plants location and establishment**

The trial site was located at a commercial wildflower plantation approximately 10 km north-east (34° 34'S, 117° 46'E) of the township Mount Barker in Western Australia. A

number of different species and varieties of *Boronia* were cultivated at the plantation, with *P. boroniae* frequently infecting the rust susceptible *B. megastigma* plants located there since the plantation was established in the late 1990's.

Rust free mature stands (12–18 months old) of *B. heterophylla*, *B. megastigma* and *Boronia* 'Purple Jarad' (*B. heterophylla* × *megastigma*) purchased from a wholesale nursery (Domas, Perth, Western Australia), were established at the plantation in August 2003. All three species are susceptible to *P. boroniae*. An existing plant row, set up with drip irrigation and fertilization, with established *B. megastigma* plants located 1 m away from the first trap plant was utilised. Eight plants of each of the three species were planted in blocks (8 blocks of three plants). Stands were double planted, such that plants were 0.7 m apart both horizontally and diagonally from the neighbouring stand, with 1.5–2 m distance between rows. No fungicides were applied to the trap plants during the trial. Between September 2003 and September 2004, the trap plants were examined monthly and the presence of any of the spore stages of *P. boroniae* documented.

#### **4.3.2 Spore catcher establishment and matrix preparation**

A new slit-type volumetric spore trap (STVS) designed at Murdoch University, Western Australia (Neumeister-Kemp *et al.* 2004), was operated in conjunction with the field trial between February and August 2004. The STVS was orientated so that air intake (10 L.min<sup>-1</sup>) was located immediately above the canopy of the trial plants and approximately 5 meters away from the row of *B. megastigma* plants established by the grower. The drum of the STVS was set to rotate once every 7 days, powered by a 12V rechargeable battery attached to a solar panel.

A length of Melinex tape (Burkard, UK) measured to the circumference of the drum was coated with a thin layer of non-toxic brushable TangleFoot adhesive (product

number E95113, Australian Entomology Supplies, NSW Australia) using the edge of a pasteur pipette. Preliminary runs found that the glue was more uniformly applied in this fashion in comparison to the aerosol applicator also available from the company. Prepared drums were replaced every seven days by the owners of the plantation and collected monthly upon each field trip.

Daily and hourly climatic data were obtained from the Western Australian Department of Agriculture automatic weather stations located in the township of Mt Barker (34° 38' 02"S, 117° 32' 00"E).

#### **4.3.3 Microscopic examination of the spore matrix**

Each strip of Melinex tape representing 7 days was sectioned into daily (24 h) strips (9.5 mm × 48 mm) using the cutting board described by Neumeister-Kemp *et al.* (2004) and mounted in 0.1 % aniline blue lactoglycerol. Daily tape sections collected between 13<sup>th</sup> February and 8<sup>th</sup> April 2004 (8 weeks) were further sectioned horizontally (4.75 mm × 48 mm), with one half mounted in 0.1 % aniline blue lactoglycerol for microscopy and the second half stored at 4 °C in a 1.5 mL microfuge tube for future DNA extraction and analysis.

Total basidiospore numbers were obtained from one longitudinal transect through the middle of the tape (Sterling *et al.* 1999) using 400× bright field magnification on an Olympus BX51 microscope. For tapes that had been sectioned horizontally, counts were completed one field of view below the sectioned edge. Basidiospores were identified by shape including the presence of a prominent apiculus, and size range. The presence of other spore types was noted but not counted, however were identified when possible to genus level.

Periodicity of basidiospore release was analysed on five high (>100) basidiospore count days (16<sup>th</sup>/17<sup>th</sup> February, 12<sup>th</sup> April, and 9<sup>th</sup>/10<sup>th</sup> May) by examination of the spore

matrix on a field-by-field view at 400× magnification in a single longitudinal count. As each field of view represented 12 min of exposure (120 views in total for each 24 h section), hourly basidiospore counts were determined by totalling consecutive sets of five fields of view.

#### 4.3.3.1 *Data analysis*

Plots of daily and hourly spore numbers versus weather variables were drawn with Microsoft® Excel 2002 and all statistical analysis conducted with the program SPSS© (Version 12.0.1, SPSS Inc., Chicago). Correlation analysis was used to determine the relationship between daily basidiospore numbers, and daily temperature (max./min.), relative humidity (max./min.), total daily rainfall, mean daily wind speed and mean daily evaporation. Spore tape sections lost due to STVS failure or processing problems were not included in the analysis. Similarly, correlation analysis of hourly basidiospore numbers and hourly air temperature, relative humidity, wind speed, rainfall, evaporation and solar radiation were calculated. Because of the non-normal distribution of both spore data sets, even after transformation (logarithmic and square root), the nonparametric Spearman's rank correlation was determined.

#### 4.3.4 **PCR-RFLP protocol for detection of *Puccinia boroniae* DNA on the spore matrix**

##### 4.3.4.1 *DNA extraction from the spore matrix*

Approximately 200mg of acid washed glass beads (425–600 µm) (product number G8772, Sigma, Australia) was added to each 24 h tape sample together with 250 µL of extraction buffer (100 mM Tris.HCl pH 8.0, 20 mM EDTA, 2 % CTAB, 1.42 M NaCl, 2 % polyvinylpyrrolidone–40). Samples were vortexed vigorously for 2 min then incubated at 65 °C for 30–60 min, sufficient to melt the adhesive and release fractured spores into solution. The entire volume was transferred to a fresh 1.5 mL microfuge

tube, to which 250  $\mu$ L chloroform:isoamyl alcohol (24:1) was added, mixed and centrifuged at 5000 g for 5 min. DNA was precipitated from the top aqueous layer with 135  $\mu$ L isopropanol and resuspended in 50  $\mu$ L molecular biology grade water. Samples were diluted 1:10 and 1:100 prior PCR amplification.

#### 4.3.4.2 PCR parameters

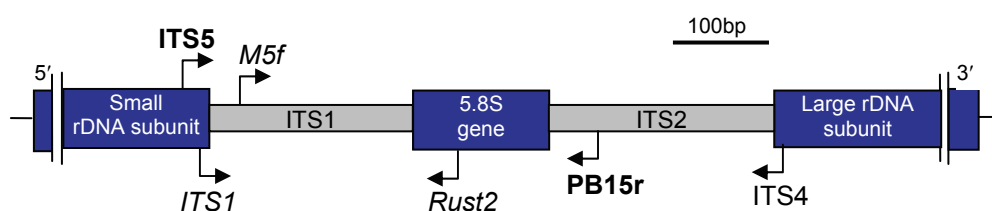
Extraction of amplifiable DNA from each spore matrix sample at each dilution was tested with universal ribosomal ITS primers ITS4 and ITS5 (TABLE 4.1, FIG. 4.1). PCR reactions were completed in 25  $\mu$ L volumes, each containing 2  $\mu$ L DNA template (neat, 1:10 or 1:100 dilution), 0.5 U Taq polymerase (Fisher Biotec, Australia), 1.5 mM MgCl<sub>2</sub>, 0.5 mM of each primer (Proligo, Australia) and 1 $\times$  PCR polymerisation buffer (Fisher Biotec, Australia). Cycling conditions were set at 95 °C for 10 min, followed by 35 cycles of 95 °C (30 sec), 54 °C (1 min) and 72 °C (1 min), with a final extension of 72 °C for 10 min.

For *P. boroniae* specific assays, several combinations of rust specific and universal primers binding within the ITS1 and ITS2 regions were tested for their ability to selectively amplify *P. boroniae* from the spore matrix (TABLE 4.1, FIG. 4.1). Primers M5f and PB15r were designed based on *P. boroniae* ITS sequences (CHAPTER 3) using the PRIME program (ANGIS) and their properties checked using NetPrimer© (PREMIER Biosoft International). Specificity of the primer sequence was compared to ITS sequences of other fungal species available on Genbank using the BLAST (Version 2.2.7) program.

Primary PCR reactions (ITS5/PB15r) were completed in 25  $\mu$ L volumes as described above with the following modifications; the DNA template was used at a dilution which gave the strongest product with ITS4/ITS5 amplification, and the annealing temperature was raised to 56 °C. Nested PCR reactions with primer pairs

**TABLE 4.1.** Sequence and specificity of PCR primers screened to detect *Puccinia boroniae* on the spore matrix.

Primer	Sequence (5' – 3')	Specificity	Reference
ITS5	GGA AGT AAA AGT CTGT AAC AAG G	Universal	(White <i>et al.</i> 1990)
ITS4	TCC TCC GCT TAT TGA TAT GC	Universal	(White <i>et al.</i> 1990)
ITS1	TCC GTA GGT GAA CCT GCG G	Universal	(White <i>et al.</i> 1990)
Rust2	TTT CAC TGT GTT CTT CAT C	Generic rust	(Kropp <i>et al.</i> 1997)
PB15r	CTA ATC ACA GCA ACA CTC AAC	<i>P. boroniae</i>	Current study
M5f	GCT CGA CCC CTT TTA AAT ATA TCA CC	<i>P. boroniae</i>	Current study

**FIG. 4.1.** Schematic diagram of the *Puccinia boroniae* ITS region indicating binding sites of the PCR primers detailed in TABLE 3.1. Primers used for primary reactions are in bold, with nested primers in italics. bp = base pairs.

ITS1/PB15r, ITS5/Rust2 and M5f/PB15r were completed as detailed for the primary reactions, using 2  $\mu$ L of a 1:20 or 1:50 diluted PCR product as template. PCR products from all assays were analysed by gel electrophoresis (1 % agarose), stained with 0.5 mg.ml<sup>-1</sup> EtBr and viewed under UV light. DNA from *P. boroniae* telia collected from the same plantation as the spore catcher was located and DNA extracted from *Puccinia hordei* urediospores were included as controls.

#### 4.3.4.3 Restriction digestion of the nested PCR products

Restriction enzymes *Dra*I, *Hae*III and *Taq*I (Fisher Biotec, Australia) were chosen and the expected fragment sizes for *P. boroniae* (TABLE 4.2) were determined by sequence analysis of the ITS region of specimens M05 and M1201T1 (CHAPTER 3) using

**TABLE 4.2.** Expected product and restriction digestion fragment sizes for nested PCR reactions of *Puccinia boroniae*.

Nested PCR primer pair	Expected PCR product length (bp)	Digested fragment sizes (bp)		
		<i>DraI</i>	<i>HaeIII</i>	<i>TaqI</i>
ITS1 and PB15r	499	–	–	–
ITS5 and Rust2	360	86, 98, 154	140, 198	–
M5F and PB15r	438	15, 39, 154, 230	57, 381	4, 202, 232

Bioedit© version 7.0.0 (Tom Hall, Isis Pharmaceuticals Inc.) (Hall 1999). Nested PCR products from primer pairs ITS5/Rust2 and M5F/PB15r were digested with the above endonucleases in 10 µL reaction volumes, containing 5 µL unpurified PCR product, 5–10 units restriction enzyme, 0.1 µg bovine serum albumin (Promega, Australia) and made up to the final volume with 1× restriction enzyme buffer provided by the manufacturer.

Digestions were completed at 37 °C (65 °C for *TaqI*) for 4–6 h, with 1 µL of 10× Orange G buffer [0.5 % w/v Orange G (Sigma, Australia), 50 % w/v sucrose, 10 mM Tris-HCl pH 8.0] added post digestion. Fragments were separated by gel electrophoresis on 2.5 % composite agarose [1.25 % NuSeive agarose 3:1 (Cambridge Bioproducts) and 1.25 % standard agarose] in 1× TBE buffer, stained with 0.5 µg.mL<sup>-1</sup> EtBr and viewed under UV light. Fragment sizes were determined by comparison to molecular weight standard pUC19 DNA/*HpaII* (Fisher Biotec, Australia). *P. boroniae* and *P. hordei* amplified PCR products were included in the RFLP analysis as controls.

#### 4.3.4.4 Sequencing of PCR products

Several bands from the nested PCR reactions were extracted from the gel using the QIAquick Gel Extraction Kit (Qiagen, Australia) and sequenced. Standard half reactions were completed, composed of 4 µL ABI PRISM<sup>®</sup> BigDye (version 3.1)



Terminator Ready Reaction Cycle Sequencing Kit mix (Applied Biosystems), 3.2 pmoles primer, 5 µL purified DNA and made up to a final volume of 10 µL with molecular biology grade H<sub>2</sub>O. Sequencing reactions were completed in a heated lid thermocycler programmed as follows: 96 °C for 4 min, followed by 25 cycles of 96 °C (10 sec), 50–55°C (5 sec) and 60°C (4 min). Post-sequence reactions were purified by ethanol precipitation according to Applied Biosystems recommendations. Purified samples were submitted to the Western Australian State Agricultural Biotechnology Centre (SABC) for sequencing, completed on an ABI373XL automated sequencer (Applied Biosystems). Sequences were edited with the program SeqEd (v1.04, PE Applied Biosystems, Foster City, California).

## **4.4 Results**

### **4.4.1 Disease development under field conditions**

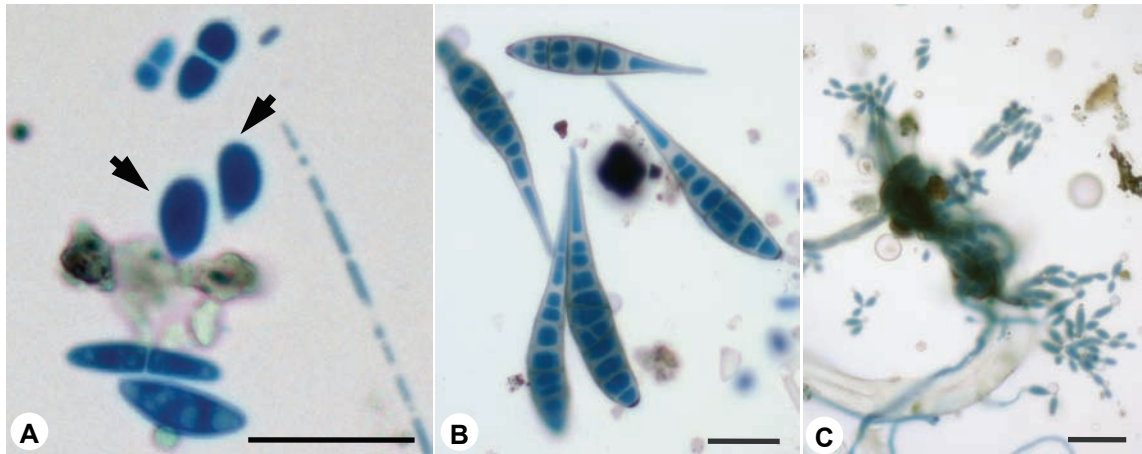
Small numbers of *P. boroniae* telia were first observed late January 2004 on the commercial *B. megastigma* plants, rising in numbers and persisting until September 2004, when the field trial ended. Between March and May 2004 pycnia of *P. boroniae* (CHAPTER 2) were detected on a number of these commercial stands. Uredia and aecia were not observed during the course of the trial. The remaining established *Boronia* species/varieties at the plantation, including one susceptible species (*B. clavata*) and three resistant varieties (*Boronia* 'Lipstick', *B. heterophylla* 'Cameo' and *B. heterophylla* 'Moonglow'), remained uninfected. During the 12 months of observation neither the telial stage nor the pycnial stage of *P. boroniae* was detected on any of the trap plants, despite adjacent plants being heavily infected and the data from the spore catcher indicating that *P. boroniae* basidiospores were present within the immediate vicinity of the trap plants. Hence, the incidence and severity of disease development was not quantified.

#### 4.4.2 Airborne basidiospores of *Puccinia boroniae* and other fungal spores observed on the spore matrix

Basidiospores were the only rust type spore observed in high numbers on the spore matrix (FIG. 4.2A), with no typical *Puccinia*-like urediospores or aeciospores observed. Numerous other spore species, including *Helminthosporium* (FIG. 4.2B), *Cladosporium* (FIG. 4.2C), *Alternaria*, *Mycosphaerella*, *Leptosphaeria*, *Epicoccum* and *Fusarium* and unidentified smuts and ascospores were captured on the spore matrix. Varying quantities of dust and debris, pollen and small insects were also present. Prolific germination of various spores on the adhesive coated Melinex tape was observed in several collections (FIG. 4.2C) though no germinating basidiospores were observed.

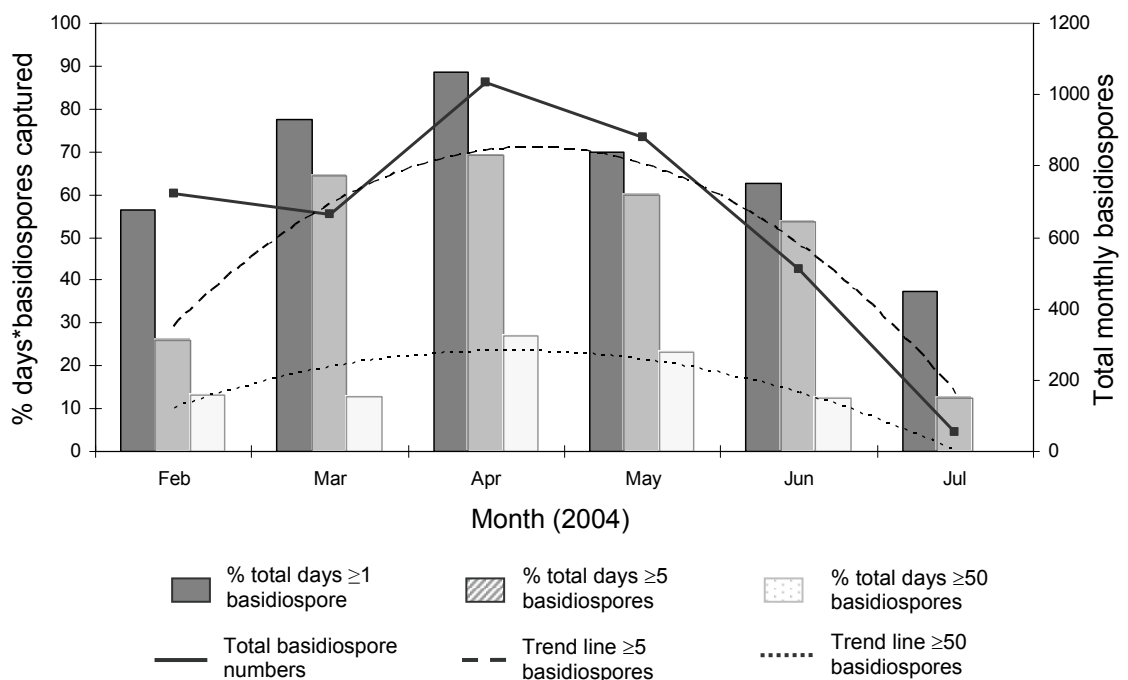
##### 4.4.2.1 Daily basidiospore counts and relationship to weather parameters

Fluctuating numbers of basidiospores were captured throughout the examination period (7<sup>th</sup> February–5<sup>th</sup> August 2004) with basidiospores first captured on the 14<sup>th</sup> February. Excluding the dates in which data could not be obtained due to technical difficulties, 155 days of spore tape was examined with basidiospores recorded on 107 (69%) days. Total daily basidiospore counts were generally low (< 50), with only 12 days recording > 100 basidiospores and only 3 of which recorded > 200 in a single longitudinal count. Highest cumulative counts were recorded in April and May (1035 and 879 basidiospores respectively) (FIG. 4.3). The number of days recording  $\geq 1$ ,  $\geq 5$  and  $\geq 50$  basidiospores in each month from February to June was calculated as a percentage of the total number of days examined in each month (FIG. 4.3). The incidence of basidiospores for each month (represented by % of days recording  $\geq 1$  and  $\geq 5$  basidiospores per day) followed a quadratic trend, increasing from February through to March, peaking in April with 88.5 and 62.9 % of days recording  $\geq 1$  and  $\geq 5$  basidiospores respectively, and then decreasing from May to July (FIG. 4.3). A similar



**FIG. 4.2.** Images of the spore matrix detailing basidiospores and commonly encountered fungal spores captured between February and June 2004.

**A.** Basidiospores of *P. boroniae* (arrows) amongst other fungal spores on the spore matrix; **B.** *Helminthosporium* spores; **C.** *Cladosporium* spp. colony developing directly on the spore matrix. Bar (all) = 20  $\mu$ m.



**FIG. 4.3.** Percentage of days in each month (February–July 2004) in which basidiospores were captured on the STVS, and total monthly basidiospore numbers.

\* Percentage of total days in month from which daily spore tapes were successfully obtained (daily data missing due to technical difficulties (STVS failure): 1<sup>st</sup>–6<sup>th</sup> Feb; 22<sup>nd</sup>, 23<sup>rd</sup>, 24<sup>th</sup>, 30<sup>th</sup> Apr; 1<sup>st</sup> May, 25<sup>th</sup>–26<sup>th</sup> Jun; 2<sup>nd</sup>–15<sup>th</sup> Jul).

trend was observed for the percentage of days in which  $\geq 50$  basidiospores were captured, showing a peak in April of 26.9 % (FIG. 4.3).

Daily basidiospores numbers were observed to rise and fall every 3–5 weeks (FIG. 4.4), most likely associated with the disease development period. However, as disease incidence and severity was not quantified (due to lack of infection on the trap plants), this relationship was not confirmed. High daily spore counts ( $> 100$  basidiospores) were frequently (but not always) associated with rainfall on the same or previous day (FIG. 4.4). Though basidiospores were captured through till 8<sup>th</sup> August 2004, fewer high spore counts days were recorded from mid May 2004, corresponding with decreasing maximum and minimum temperatures (FIG. 4.4). In general, daily basidiospore counts were not significantly correlated with the weather variables examined (TABLE 4.3) with only the daily minimum temperature ( $r_s = 0.17$ ,  $p < 0.05$ ) and total daily rainfall ( $r_s = 0.25$ ,  $p < 0.01$ ) positively correlated with daily basidiospore numbers.

#### 4.4.2.2 *Periodicity of basidiospore release and relationship to weather parameters*

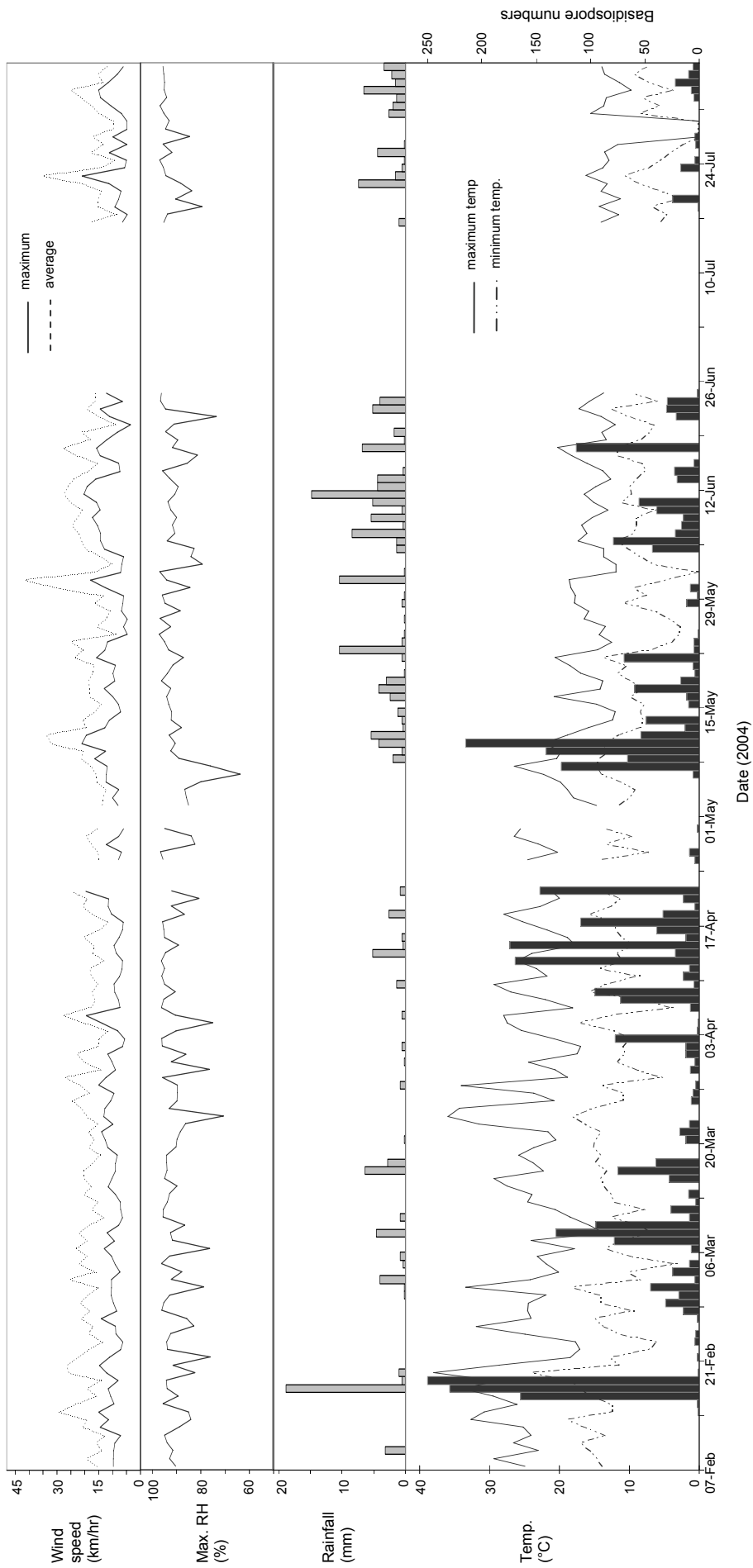
A strong periodicity of basidiospore release (capture) was observed from plots of basidiospores captured per hour for each of the 24 h segments examined. Spore release generally occurred between sunset and sunrise. Daytime hours showed low to absent numbers of basidiospores. On average, the highest number of basidiospores was captured between 01:00 and 08:00 h, peaking between 02:00 and 05:00 h (FIG. 4.5).

**TABLE 4.3.** Correlation coefficients ( $r_s$ ) between daily spore counts and daily weather variables.

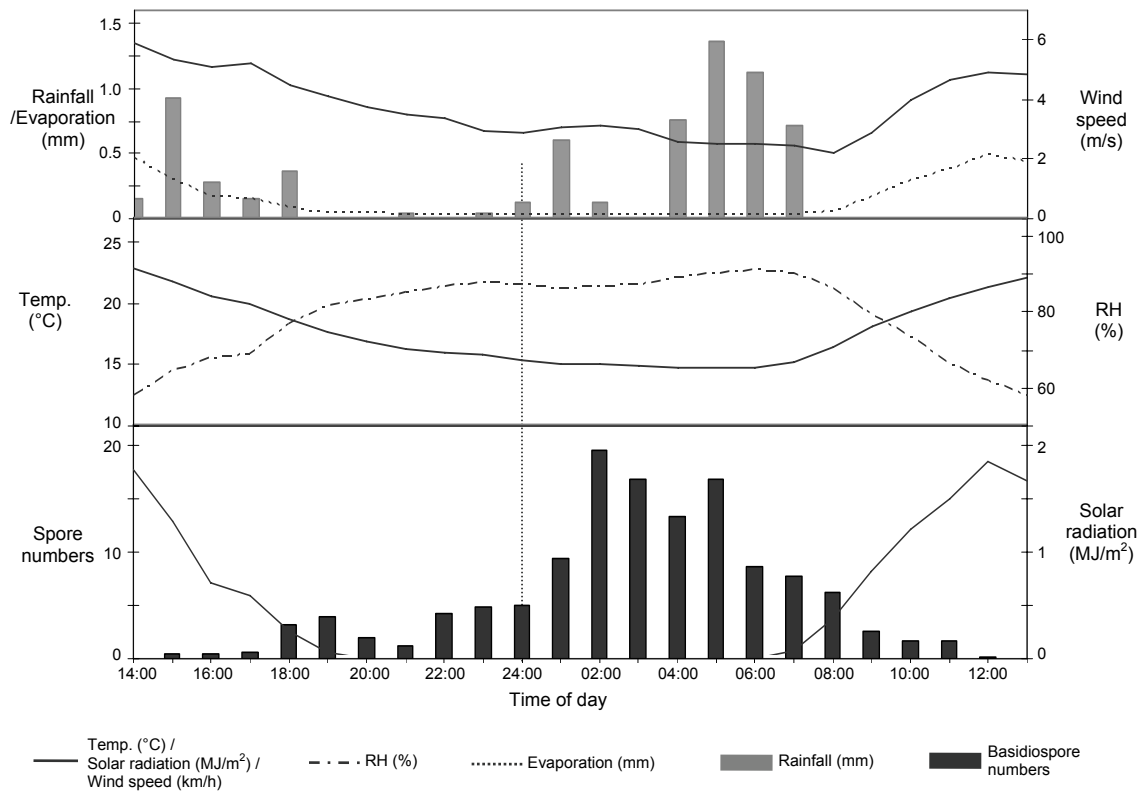
Temperature (°C)		Relative humidity (%)		Wind speed (km.hr <sup>-1</sup> ) <sup>a</sup>	Evaporation (mm) <sup>a</sup>	Total rainfall (mm)
Min.	Max.	Min.	Max.			
0.17	0.07	0.06	0.13	0.13	0.03	0.25
(0.03)	(0.39)	(0.45)	(0.11)	(0.11)	(0.72)	(<0.01)

Note: Values in parentheses are probability associated with  $H_0 = |r| = 0$ .

<sup>a</sup>Mean daily wind speed and evaporation.



**FIG. 4.4.** Daily basidiospore numbers captured from 7<sup>th</sup> February–5<sup>th</sup> August 2004 at the Mt Barker plantation, in comparison to temperature, maximum relative humidity (RH), daily rainfall and wind speed (maximum/average). Breaks in graphs indicate missing data due to technical problems; 22<sup>nd</sup>, 23<sup>rd</sup>, 24<sup>th</sup>, 30<sup>th</sup> April; 1<sup>st</sup> May, 25<sup>th</sup>–30<sup>th</sup> June; 2<sup>nd</sup>–15<sup>th</sup> July.



**FIG. 4.5.** Mean hourly basidiospore counts, air temperature, relative humidity (RH), rainfall, evaporation and wind speed from 5 high basidiospore days (16<sup>th</sup>/17<sup>th</sup> Feb, 12<sup>th</sup> Apr and 9<sup>th</sup>/10<sup>th</sup> May) showing periodicity of basidiospore release.

Visually, plots of average hourly basidiospore numbers versus mean hourly weather variables showed increasing spore numbers corresponding with increasing relative humidity, and decreasing air temperature, solar radiation, wind speed and evaporation (FIG. 4.5). Correlation analysis confirmed these observations, with a significant ( $p < 0.01$ ) positive correlation of basidiospore numbers with relative humidity, and significant ( $p < 0.01$ ) negative correlation with temperature, solar radiation, wind speed and evaporation for the 5 high basidiospore count days examined (TABLE 4.4).

In addition to correlation analysis of the hourly basidiospore numbers with the corresponding hourly weather variables, correlation analysis of the 3, 6, 9 and 12 h running averages of air temperature, relative humidity, rainfall, solar radiation and evaporation prior to basidiospore capture were also conducted (TABLE 4.4). The highest

**TABLE 4.4.** Correlation coefficients ( $r_s$ ) between hourly and running means of weather variables, and the hourly basidiospore counts for 5 high basidiospore count days.

	Air temperature (°C)	Relative humidity (%)	Solar radiation (kJ/m <sup>2</sup> )	Rainfall (mm)	Wind speed (m.s <sup>-1</sup> )	Evaporation (mm)
Hourly <sup>a</sup>	-0.42 (<0.01)	0.57 (<0.01)	-0.57 (<0.01)	0.07 (0.48)	-0.42 (<0.01)	-0.61 (<0.01)
3 hour <sup>b</sup>	<b>-0.44</b> (<0.01)	0.62 (<0.01)	-0.66 (<0.01)	0.18 (0.05)	–	-0.67 (<0.01)
6 hour <sup>b</sup>	<b>-0.44</b> (<0.01)	<b>0.64</b> (<0.01)	<b>-0.74</b> (<0.01)	0.19 (0.04)	–	<b>-0.72</b> (<0.01)
9 hour <sup>b</sup>	-0.35 (<0.01)	0.58 (<0.01)	-0.72 (<0.01)	0.20 (0.02)	–	-0.70 (<0.01)
12 hour <sup>b</sup>	-0.21 (0.02)	0.45 (<0.01)	-0.59 (<0.01)	<b>0.31</b> (<0.01)	–	-0.58 (<0.01)

Note: Values in parentheses are probability associated with  $H_0 = |r| = 0$ .

Running mean producing highest correlation coefficients ( $r_s$ ) for weather variable in bold.

<sup>a</sup>Correlation analysis conducted with corresponding hours of weather variables.

<sup>b</sup>Correlation analysis conducted with 3, 6, 9 and 12 h running mean of weather variables prior to basidiospore capture.

(significant) correlations between hourly basidiospore numbers, relative humidity, solar radiation and evaporation were concluded from the 6 h running averages, and both the 3 and 6 h running averages for temperature (TABLE 4.4). Rainfall, which recorded no significant ( $p = 0.48$ ) correlation with basidiospore release when analysed with the corresponding hourly rainfall values, produced a significant ( $p < 0.05$ ) positive correlation with basidiospore numbers at 3, 6 and 9 h running averages, with the 12 h running average showing the highest positive correlation ( $r_s = 0.31$ ,  $p < 0.01$ ) (TABLE 4.4). Despite this positive correlation, rainfall was not always associated with the capture of basidiospores as seen in the data from 16<sup>th</sup> February, where high basidiospore numbers were quantified but no rainfall was recorded for the 6 days previous (FIG. 4.4).

#### 4.4.3 PCR-RFLP detection of *Puccinia boroniae* DNA on the spore matrix

Amplifiable DNA was extracted from 56 consecutive 24 h spore matrix samples collected between 13<sup>th</sup> February and 8<sup>th</sup> April 2004. Multiple bands were present in reactions completed with the universal primers ITS4/ITS5 indicating the presence of

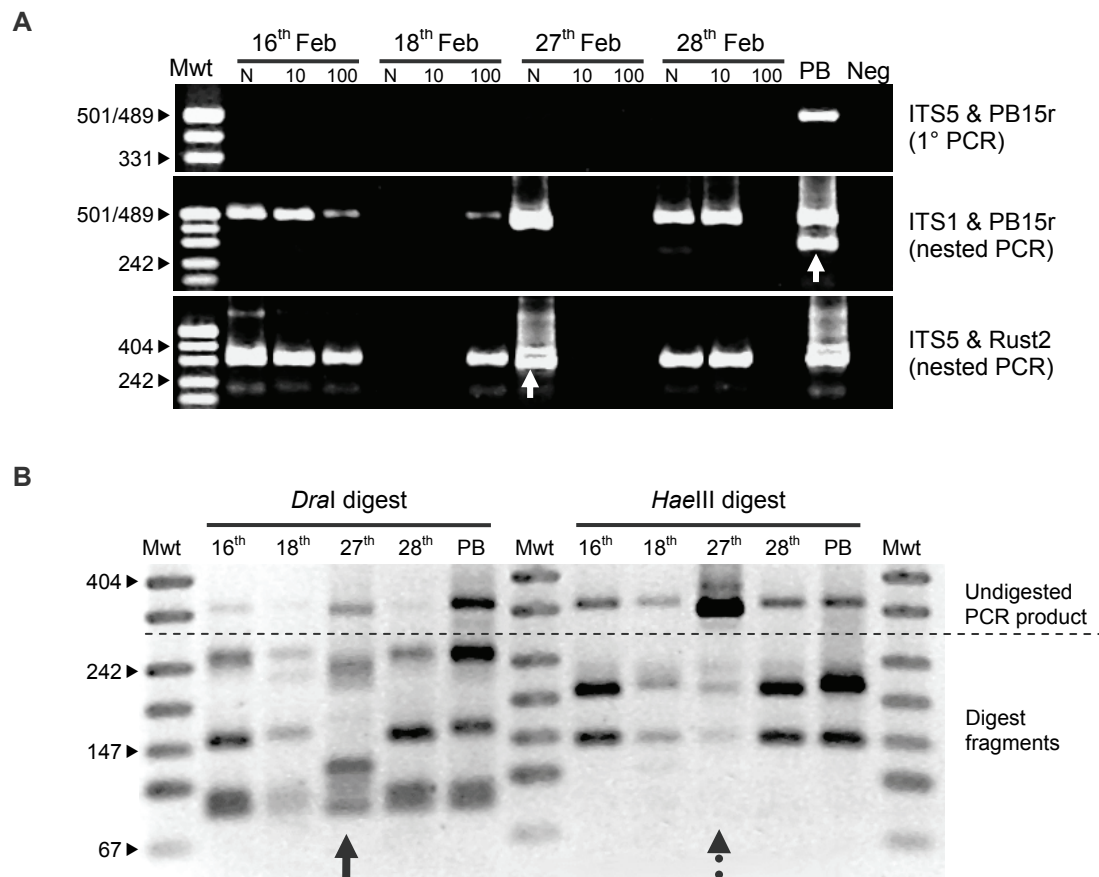
DNA from a number of different fungal species. This was in agreement with microscopic examination of the corresponding spore tape half, showing the presence of numerous spore types/species. Several samples required dilution up to 1:100 before a PCR product was obtained, suggesting the extraction method did not efficiently remove all PCR inhibitors that were present on the spore tape.

The specificity of the nested PCR protocol using primer pairs ITS1/PB15r and ITS5/Rust2 was determined by initially screening 4 spore matrix samples (at each template dilution) shown to have basidiospores microscopically and comparing it to DNA amplified from *P. boroniae*. Only the *P. boroniae* positive control produced a visible product in the primary PCR reaction (primers ITS5/PB15r) (FIG. 4.6A). Within the nested PCR reactions, both primer sets produced a band corresponding to the size of *P. boroniae* in the positive control (FIG. 4.6A). However, with the nested primer pair ITS1/PB15r, a second band was formed in the positive control which when sequenced was not *P. boroniae* DNA (FIG. 4.6A). Therefore, this primer pair was excluded from further use. Amplification of the positive control with primers ITS5 and Rust2 showed greater specificity, though some minor non-specific banding (smearing) was present above the ITS amplified fragment (FIG. 4.6A).

A strong band corresponding to the size of *P. boroniae* was obtained in 3 out of the 4 spore matrix samples screened with nested primers ITS5/Rust2 (FIG. 4.6A). The PCR product from the fourth spore matrix sample (27<sup>th</sup> February) was approximately 20 bp smaller than the positive control. Restriction digestion profiles generated with *HaeIII* and *DraI* indicated that both *P. boroniae* and another fungal species were being co-amplified with the nested primers in this sample (FIG. 4.6B). This was clearly apparent with the *HaeIII* digest, where the majority of the PCR product remained undigested, but faint bands corresponding in profile to *P. boroniae* were also present (FIG. 4.6B). The nested PCR product from the 27<sup>th</sup> February was sequenced and



compared to sequences on Genbank. High sequence similarity (98 %) was obtained with several *formae speciales* of *Puccinia graminis* (accession numbers: AF468044, AY114289 and PPORGBHAD, -HAI, -HAK, -HAG, -HAF, -HAN). Analysis of these *P. graminis* ITS sequences revealed no *Hae*III recognition site(s).



**FIG. 4.6.** Primary and nested PCR amplification and restriction digestion data of 4 spore matrix samples from February 2004, which microscopically showed the presence of basidiospores. Mwt = Molecular weight marker (bp); N, 10, 100 = Undiluted, 1:10 and 1:100 dilutions of the DNA template respectively; PB = *P. boroniae* positive control; Neg = Negative (no DNA) control.

**A.** Primary and nested PCR data showing amplification of rust DNA from the spore matrix at different dilutions of DNA template. Arrows indicates bands extracted and sequenced; **B.** ITS5/Rust2 amplified products from **A** digested with *Dra*I and *Hae*III highlighting the co-amplification of two rust species in the 27<sup>th</sup> February sample. *Dra*I digestion (solid arrow) clearly shows a different restriction profile from the *P. boroniae* control, whereas the *Hae*III digest (broken arrow) shows a strong undigested PCR product, as well as faint digested fragments that corresponded to the *P. boroniae* control.

From these preliminary results, it was concluded that the use of a single *P. boroniae* specific primer in the primary and/or nested PCR reaction was insufficient to exclude non-*P. boroniae* DNA from amplifying. Therefore, a second primer (M5f) was designed based on *P. boroniae* ITS sequences to use as a nested primer with PB15r. This primer had a greater number of nucleotide differences between the most closely matched fungal sequences on Genbank (FIG. 4.7). This combination of primers in the nested PCR reaction produced a higher level of specificity. This was indicated by the amplification of a single product in the 27<sup>th</sup> February sample (FIG. 4.8A) corresponding in restriction profile to *P. boroniae*. However, not all non-specific amplification was eliminated, as the *P. hordei* control produced a PCR product (FIG. 4.8A). Varying the annealing temperature and MgCl<sub>2</sub> concentration did not increase specificity.

Though the nested PCR technique alone was insufficient to specifically detect *P. boroniae*, the combined PCR-RFLP analysis was able to distinguish between the different amplification products (FIG.4.8B,C), including samples in which co-amplification of *P. boroniae* with other fungal species had occurred. Based on the restriction profiles obtained, it was concluded that at least 4 other fungal species were

<b>PB15r primer</b>		5' CTAATCACAGCAACACTCAAC 3'
<i>P. allii</i>	gbAY187091	.....T.....
<i>P. recondita</i>	gbAY187088	.....T.....
<i>P. triticina</i>	gbAY187087	.....G.....
<i>P. hordei</i>	gbAF511086	.....G.....
<i>P. thlaspeos</i>	gbPPOITSG	TGGT.....
<i>P. monoica</i>	gbPPOITS	TGGT.....
<b>M5f primer</b>		5' GCTCGACCCCTTTTAAATATATCACC 3'
<i>P. striiformis</i>	gbAY114292	.....A..C.....
<i>P. thlaspeos</i>	gbPTU88217	.....CCA.C.A
<i>P. recondita</i>	gbAF511082	.....C.TA.C.A
<i>P. triticina</i>	gbAY187087	.....C.TA.CAT
<i>P. sessilis</i>	gbAY217135	.....C.TACC.A
<i>P. sorghi</i>	gbAY114291	.....CTC.C.CAA

**FIG. 4.7.** Alignment of *Puccinia boroniae* specific primers, PB15r and M5f, with the most similar fungal ITS sequences resulting from a BLAST search of Genbank. Dot = 100% identity.



being amplified in addition to *P. boroniae* with the chosen primers, with several of the PCR products producing the same profile over separate days (eg. 4<sup>th</sup> and 9<sup>th</sup> March) (FIG. 4.8B). It is likely that different rust species were being detected with these primers; however sequencing data of the different products were not obtained.

Overall, of the 56 spore tape samples screened, 44 were recorded to have basidiospores present when examined microscopically. Thirty-one of these samples (70 %) produced a nested PCR product when amplified with primer pair M5f/PBr15, of which 23 (74 %) were positive for *P. boroniae* by RFLP analysis. Of the 12 samples that did not show basidiospores on the tape, five amplified with the nested primers, of which two were positive for *P. boroniae*. In those samples which produced a positive result for *P. boroniae* by PCR-RFLP, the corresponding basidiospore counts varied from 1–250 basidiospores with overall total spore numbers (of all different species) varying between < 10 to > 100 spores per field of view. Samples which recorded high basidiospore numbers microscopically did not always produce a nested PCR product or a positive RFLP profile. The data showed that *P. boroniae* could be identified from tape sections containing high numbers (> 100 spores per field of view) of different fungal spores using the nested PCR-RFLP protocol, using at least two restriction enzymes. The method, though qualitative only, provided conclusive data showing *P. boroniae* basidiospores were released within the vicinity of the trap plants.

## **4.5 Discussion**

The aims of this study were to examine the disease cycle of *P. boroniae* in the field and the environmental conditions conducive for dispersal of basidiospores and disease development. Pycnia of *P. boroniae* were observed on the same host as the telial stage, indicating that the lifecycle is autoecious. Uredia and aecia were not observed on infected hosts, nor were urediospores or aeciospores observed on the spore tape: this

provides further evidence that the lifecycle of *P. boroniae* is microcyclic. Investigations into the airborne basidiospores of *P. boroniae* revealed that basidiospores were predominantly released at night, with the number of basidiospores present correlated with temperature and relative humidity. To the best knowledge of the author, this study also reports for the first time the detection of rust basidiospores from airborne inoculum using PCR-RFLP analysis.

#### 4.5.1 Lack of disease development on the *Boronia* trap plants

Telia of *P. boroniae* were observed on the commercial *B. megastigma* stands located at the trial site between January and September 2004, with small numbers of pycnia observed during March–May 2004. However, the rust susceptible *Boronia* trap plants established at the trial location from August 2003–September 2004 did not become infected with *P. boroniae*. Several reasons are suggested for the unsuccessful development of rust disease on these trap *Boronia* spp.; (i) viable inoculum of *P. boroniae* was not reaching the trap plants, (ii) the three *Boronia* spp. established as trap plants were showing race non-specific or race specific resistance (Burdon *et al.* 1996), or (iii) the *P. boroniae* pathogen located at this property is a variant (physiologic race) exhibiting cultivar-specific pathogenicity (Littlefield 1981).

Data from the STVS, which was set up directly above the canopy of the trap plants, indicated that basidiospores of *P. boroniae* were trapped within the vicinity of the plants. Though the data did not indicate the viability of the basidiospores, as the commercial stands of *B. megastigma* immediately adjacent to the trap plants (1 m away) developed heavy levels of rust over the trial period, viable inoculum was likely to be present. Therefore, this reason was excluded as a possible cause. As it is well documented that plant age, developmental stage and plant health can affect the development of disease (Bruckart *et al.* 1996; Poteri *et al.* 2001; Agrios 2005), it is also important to acknowledge that the trap plants were mature (12–18 months) healthy

stands, established 6 months before the onset of rust disease at the plantation, developing new leaves and flowers at the same time as the commercial stands, and irrigated and fertilized at the same levels as the commercial stands. Therefore the age and stage of host plant development was also excluded as likely causes of unsuccessful infection.

The second possibility is that all stands of the three species of *Boronia* planted out at this plantation were resistant to *P. boroniae*, either entirely to *P. boroniae* or solely in respect to the pathogen at this location. Individual plants of the same species of *Boronia* propagated from seed are able to show resistance to *P. boroniae* (Adam 1932), with growers in the past encouraged to seed propagate their *Boronia* and then stem propagate plants exhibiting resistance to the pathogen. This approach is no longer encouraged, primarily due to the variability of the harvested product (i.e. stem length, floral display and harvesting time) (Plummer 1997) which is no good for market reasons, and partially due to the low viability of seed propagated material (Plummer 1996; 1997). Therefore, it is possible that the trap plants used may have been sourced from stock plants resistant to *P. boroniae*.

However, genetic analysis of the diversity of *P. boroniae* in the current study (CHAPTER 3) indicated the presence of two genetically different rust types present at this location in previous years; one type present on *B. heterophylla* and the second on *B. megastigma*. Commercial cultivation of *B. heterophylla* was discontinued at the plantation in late 2000/early 2001 due to constant rust epidemics, and analysis of the diversity of *P. boroniae* within the *B. megastigma* crop (CHAPTER 3) showed that only the second rust type was present at the plantation (CHAPTER 3). This diversity, together with the absence of *P. boroniae* on all three species of *Boronia* trap plants as well as the commercial stands of *B. clavata*, a known rust susceptible species, suggests the possibility that the rust pathogen at this plantation may be a physiological race of

*P. boroniae*, exhibiting cultivar-specificity for the commercial *B. megastigma* present, as opposed to the trap plants showing resistance.

Without further experimentation, it is impossible to definitively conclude the basis for the absence of infection during the trial. It is suggested that controlled pathogenicity tests with these *P. boroniae* specimens should be completed on a differential set of *Boronia* spp., including the specific *B. megastigma* cultivar grown at the Mt Barker plantation.

#### **4.5.2 Effect of weather parameters on airborne basidiospores of *Puccinia boroniae***

Between February and August 2004, basidiospores were recorded on 69 % of the days examined, peaking in total number, daily incidence and daily numbers during April (mid-autumn). Correlative analysis indicated relationships between daily basidiospore numbers, and the minimum daily temperature and the presence of rainfall. A distinct diurnal periodicity of basidiospore release was concluded, with basidiospores initially becoming airborne at dusk and peaking in numbers in the hours just before dawn (between 02:00 and 05:00 h). Concomitant with increasing hourly basidiospore numbers was decreasing air temperature, evaporation, wind speed and solar radiation, and increasing relative humidity. As the daily data suggested that weather conditions experienced in the field favoured the release and dispersal of basidiospores throughout the trial period, fluctuations in the basidiospore numbers would be attributed to (i) conditions favouring basidiospore production (i.e. teliospore germination), (ii) the level of disease present in the crop (i.e. number of mature basidiospore producing teliospores), and (iii) the setup of the STVS and analysis methods employed in the study.

Successful basidiospore formation is initially reliant on the successful germination of teliospores, which in turn is affected by the environmental conditions, primarily moisture availability and temperature. This relationship was clearly seen in the hourly data, where the highest correlations between the weather parameters and basidiospore numbers concluded in this study were attained from the 6 h running averages prior to basidiospore capture. This data would indicate that the weather conditions in the hours preceding basidiospore capture during which teliospores were germinating attributed to the number of airborne basidiospores released. The diurnal periodicity concluded in this current study has been reported for many basidiospore producing fungal species including rusts (Mendgen 1984; Gold and Mendgen 1991; Van Arsdel and Krebill 1995; Craig and Levetin 2000), where due to the fragility of the hyaline spores, night-time release is important to prevent desiccation by high temperatures and direct sunlight.

Correlative analysis of the daily data was less informative, though significant positive relationships with minimum temperature and rainfall were concluded. The relationship between daily minimum temperatures would suggest that at very low temperatures, teliospore germination and subsequent release of airborne basidiospores occurs less frequently. This relationship was also concluded under controlled experimental trials, where teliospore germination and basidiospore formation in *P. boroniae* was significantly lower when temperatures fell below 15 °C (CHAPTER 6). Despite both the hourly and daily data showing significant positive correlations with rainfall the capture of basidiospores was not always associated with rainfall. In regard to basidiospore formation, this data may indicate that the moisture requirements for teliospore germination are met by other environmental factors not analysed during the present study, such as dew formation. However, periods of heavy or extended rainfall could have had a detrimental effect on the dispersal of basidiospores of



*P. boroniae*, with basidiospores washed downwards, away from spore trap (Sache 2000).

The level of disease (incidence and severity) within the crop would very likely have attributed to the fluctuating numbers of basidiospores captured, though without quantifiable data, this relationship cannot be confirmed. It is suggested that the location of the diseased plants in relation to the spore catcher, the possible dispersal (travel) distance and correct identification of the basidiospores may have had a greater influence on the data. Wind direction, which was not assessed, would have had a great impact on the daily spore numbers as well as the number of days on which basidiospores were trapped. This is due to the STVS being set up above the field trap plants and not being totally surrounded by infected *Boronia* plants. Therefore any wind changes directing spores away from the trap plants would have artificially decreased the number of basidiospores captured by the STVS. The reasoning behind the location of the STVS was that basidiospore counts and the incidence and severity of disease on the trap plants could be quantified and any relationships determined.

Basidiospore numbers may have been artificially lowered (or raised) by inaccuracies in identifying the spores microscopically and the single longitudinal count method. Few defining characteristics beyond the size range and prominent apiculus are available for basidiospores of *P. boroniae* (CHAPTER 2). Levetin (1990; 1991) highlighted the difficulties in identifying hyaline basidiospores to species level, with Sterling *et al* (1999) suggesting that 1000× magnification is required for accurate identification. However, such a high magnification would further decrease the area examined in spore tapes, either resulting in less accurate representation of the total spore numbers or requiring more area of the tape to be examined (representing a large increase in analysis time). As spores are rarely uniformly disturbed on trapping surfaces (Kung'u 2004), more accurate information would have been provided by

examination of the total trapping surface area. Sterling *et al.* (1999) reported that the concentration of basidiospores (species not identified) determined from a single traverse count were dramatically lower in comparison to when the total trapping area was quantified. However, they also report that at 1000× magnification, 82 longitudinal traverses per slide would be required to study the entire area (Sterling *et al.* 1999), greatly increasing the time required to examine all spore data. The development of image analysis programs designed to identify fungal spores such as those reported by Benyon *et al.* (1999) and Mitchell *et al.* (1997) may be of limited use in rust basidiospore analysis, as the requirement for defining morphological characteristics to differentiate species is still present.

Many different adhesives are used in spore traps, with non-toxic mixtures of Vaseline and paraffin wax routinely used (Warner *et al.* 2000). Other mixtures have included toxic compounds such as phenol (Chen *et al.* 2003). Generally used as an insect trap adhesive, the commercially available non-toxic adhesive used in this study (Tanglefoot) was found to be resilient to the harsh climatic conditions experienced in the field in Western Australia and the processing requirements of the study, with no dissolving or streaming (detachment) of captured spores observed. Uniform application and high transparency allowed for easy microscopic detection of fungal spores. The germination of numerous fungal spore types directly on the adhesive may be a useful application in identification and quantification of viable spores. The absence of germinating basidiospores on the tape was likely due to non-viability of the spores, however, as the time frame between capture and germination of the spores was not determined, nor the environmental conditions in which the spore tape was stored prior to processing, the viability cannot be concluded.

### 4.5.3 PCR detection of airborne basidiospores of *Puccinia boroniae*

The data reported in the current study indicated that *P. boroniae* DNA could be positively identified from the spore matrix containing numerous other fungal species and high total spore numbers using a combination of nested PCR and RFLP analysis. A minimum of two restriction endonucleases (Gardes and Bruns 1996) were required for positive identification of *P. boroniae* to species level.

The disparity between the microscopy counts and PCR-RFLP data would likely have been a result of one or more different experimental factors; (i) inaccuracies in the identification and quantification of the basidiospores as discussed earlier (SECTION 4.5.2), (ii) two separate sections of the spore matrix were studied for microscopy and molecular analysis, and the presence and numbers of basidiospores would not be reflected equally on each half, and (iii) one or more steps in the nested PCR-RFLP analysis, including DNA extraction, primer design or amplification parameters, may have adversely effected the results and these factors are discussed further.

Several of the screened samples required dilution of up to 1:100 before producing a PCR product with the universal primers ITS4 and ITS5. This indicated that the extraction method did not sufficiently remove all PCR inhibitors that may have been present on the tape in the form of dust/debris, pollen or insects. At this dilution, *P. boroniae* DNA (if present) may have been diluted to such an extent that PCR amplification would not produce a sufficient product to be visible on an agarose gel. Disruption of *P. boroniae* basidiospores by simply vortexing the samples in the presence of acid washed beads, together with low numbers of basidiospore present in the DNA extraction may have contributed to a poor PCR amplification result. Williams *et al.* (2001) reporting that undisrupted spores of *Penicillium roqueforti* when added to the PCR mix, were not detected by PCR when spore quantities were less than 1000. However, in this current study, amplification products were achieved in several samples

where microscopically, only few basidiospores were counted. Therefore, though spore disruption may be improved by the use of bead grinders as described by several authors (Williams *et al.* 2001; Calderon *et al.* 2002; Freeman *et al.* 2002), it is more likely that better elimination of PCR inhibitors through improved DNA extraction techniques would increase the detection ability of the protocol.

Despite the inherent problems in the DNA extraction method, it is most likely that the design of the *P. boroniae* specific primers and the PCR cycling conditions significantly contributed to the detection ability of the PCR-RFLP technique employed. The primers designed for *P. boroniae* were limited by the areas of the ITS sequence from which primers with acceptable properties and sufficient sequence variation in comparison to other rust/fungal species could be constructed. Use of alternative regions such the IGS2 region sequenced for *P. boroniae* (CHAPTER 3) together with further PCR optimisation would likely provide greater specificity such that the nested PCR technique could be used without subsequent RFLP analysis.

Similar to other reports detailing the use of molecular techniques for airborne fungal spore identification, the detection of airborne *P. boroniae* basidiospores in this study provided only qualitative, not quantitative data. Alternatively real time quantitative PCR (Q-PCR) together with the use of species-specific primers would provide the opportunity for quantitative data of airborne pathogens to be determined (Schweigkofler *et al.* 2004). Other authors have reported the development of immunodetection methods for identification and quantification of airborne spores (Kennedy *et al.* 1999; Kennedy *et al.* 2000).

#### **4.5.4 Conclusions**

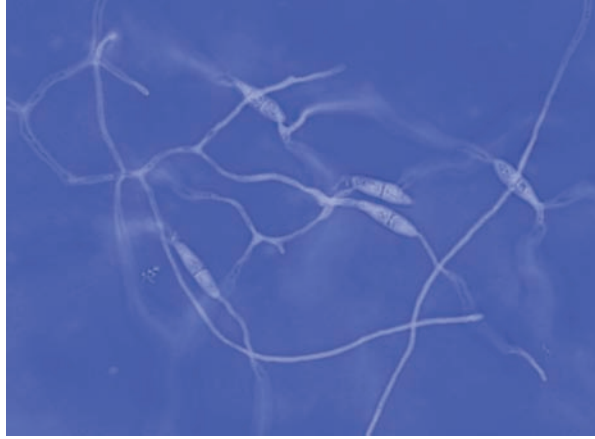
The findings in this study add weight to the microcyclic lifecycle classification for *P. boroniae* concluded in CHAPTER 2. Uredia and aecia were not observed on infected

*Boronia* plants, nor were urediospores or aeciospores, both wind dispersed infective spore stages of rust fungi, observed on the spore matrix. The relationship between weather conditions and the dispersal of basidiospores of *P. boroniae* examined in this study provides relevant information for commercial growers in regard to control of *P. boroniae* through fungicide application. It was found that microscopic identification and quantification of airborne *P. boroniae* basidiospores was subjective and difficult. It is suggested that further work in optimising the PCR-RFLP technique would allow for a more accurate detection method for the pathogen. This technique could be applied to further advance the understanding of the epidemiology of other microcyclic rust fungi.

---

## CHAPTER 5

### ***SPHAERELLOPSIS FILUM:*** **MYCOPARASITE OF *PUCCINIA BORONIAE***



Germinating pycnidiospores of *Sphaerellopsis filum*

**Published as:** Driessen SA, O'Brien PA, Hardy GESTJ (2004) First record of the mycoparasite *Sphaerellopsis filum* on *Puccinia boroniae* in Australia. *Australasian Plant Pathology* **33**, 463–464.

## 5.1 Chapter Abstract

*Sphaerellopsis filum* (teleomorph *Eudarluca caricis*), a known mycoparasite of rust fungi, was isolated for the first time from teliosori of *Puccinia boroniae* in Australia.

## 5.2 Introduction

Obligate biotrophic phytopathogenic fungi such as the rust fungi may themselves be susceptible to host colonization by other fungal species, an occurrence referred to as mycoparasitism or previously hyperparasitism. The later term refers to parasites whose host is parasitic itself in nature, but the term is generally considered obsolete (Kirk *et al.* 2001). For example, *Fusarium chlamydosporum* is parasitic on urediospores of *Puccinia arachidis* (groundnut rust) and is capable of degrading spores and inhibiting germination of the spores (Mathivanan *et al.* 1998). *Cladosporium* spp. have been reported to be mycoparasitic on bean rust, *Uromyces appendiculatus* (Assante *et al.* 2004), violet rust, *Puccinia violae* (Traquair *et al.* 1984), *Puccinia horiana* (Sheta 1996) and the pine rusts, *Cronartium flaccidum* and *Peridermium pini* (Moricca *et al.* 1999; Moricca *et al.* 2001). *Verticillium lecanii* and *Sphaerellopsis filum* (teleomorph *Eudarluca caricis*) are documented as parasitic on a variety of different host rust genera and species (Kranz 1981; Kranz and Brandenburger 1981; Srivastave *et al.* 1985; Yuan *et al.* 1998). Other obligate biotrophs such as those causing powdery mildews may be parasitised by fungi such as *Ampelomyces* spp. and *Phoma glomerate* (Kranz 1981; Sullivan and White 2000; Kiss 2001).

Though mycoparasitism is not an uncommon occurrence, the transition of a naturally occurring mycoparasite-phytopathogen interaction to a successful commercial biocontrol agent occurs less frequently. An example of a successful fungal biocontrol agent based on mycoparasitism is *Ampelomyces quisqualis*, commercially available for the control of powdery mildew on grapes and other crops (Sullivan and White 2000).

Other known mycoparasites such as *E. caricis* are currently under investigation for their ability to control their rust host (Yuan *et al.* 1999; Pei *et al.* 2003).

Whilst studying the biology of the telial stage of *P. boroniae*, pycnidia of an unknown fungus were found extruding through several teliosori examined from rust infected *Boronia heterophylla* leaves. This was the first record of *P. boroniae* being infected by a mycoparasite, therefore, the objective of the study were to identify the mycoparasite by morphological examination and sequencing of the ITS region for comparison against gene sequence databases.

### **5.3 Material and Methods**

#### **5.3.1 Fungal isolation and culture**

The mycoparasite was first isolated in August 2003 from a neglected *Boronia* plantation in Albany, Western Australia (34° 99'S, 117° 95'E) where *B. heterophylla* plants were heavily infected with *P. boroniae*. Subsequent isolations of the mycoparasite were made from the same plantation early in the following rust season (late February–April 2004). Pycnidia of the mycoparasite were also observed on a dried specimen of *P. boroniae* telia on *B. megastigma* leaves (author's own herbarium specimen) collected in August 2000 from the Kalgan region (34° 54'S, 118° 0'E) in Western Australia.

Field specimens of *P. boroniae* telia infected with the mycoparasite were separated from the bulk of the rust infected plant material and stored separately in brown paper bags at 4 °C. Several pycnidia were removed with a fine sterile needle and placed onto individual ½ strength potato dextrose agar (Difco) (½PDA) plates. Plates were incubated at 20 ± 1 °C under cool-white fluorescent light. After 12 days, the fungus was subcultured onto full strength PDA plates and re-incubated at 20 ± 1 °C. A voucher specimen of the fungal culture was lodged at the Western Australian Department of Agriculture Plant Pathogen Collection (WAC11350).



### 5.3.2 Identification of the mycoparasite

#### 5.3.2.1 Culture and fungal morphology

Single spore cultures were prepared by emulsifying a small quantity of the white mucous substance containing released pycnidiospores from the ½PDA cultures into 0.5 mL sterile distilled H<sub>2</sub>O and plating out onto PDA. After 24 hours incubation at 20 °C, single germinating spores were transferred onto fresh PDA plates using a sterile needle and incubated at 20 °C for 2 weeks. Colony morphology was examined daily.

Freehand sections of rust telia exhibiting embedded pycnidia were made with a sharp razor blade and mounted directly into lactoglycerol cotton blue. Sections were viewed under oil at 1000× magnification on an Olympus BH-2 microscope using bright field microscopy and differential interference contrast (DIC) optics. Photographs were taken with the attached Olympus DP10 digital camera and edited for clarity where necessary with Adobe Photoshop® 7.0.

Squash mounts of single pycnidia were mounted in both lactoglycerol and 0.05 % lactoglycerol cotton blue and examined under oil as described above to determine the mode of conidiogenesis. Pycnidiospores from field and culture specimens were examined by preparing squash mounts in distilled water. Spore dimensions were obtained by photographing random fields at 400× bright field magnification on an Olympus BX51 microscope attached to a MicroPublisher 3.3 RTV photographic unit (Olympus, Australia). Length and width of 30 pycnidiospores were measured using Olysia BioReport Imaging Software version 3.2 (Olympus, Australia). Differences between the means of the field and culture specimens was tested with a one-way ANOVA using the software SPSS (version 12.0.1, SPSS Inc., Chicago).

### 5.3.2.2 *ITS region analysis*

Genomic DNA was extracted from mycelium and pycnidia of the original PDA subculture after 12 days incubation by the modified CTAB method outlined in CHAPTER 3 (SECTION 3.3.2). The DNA pellet was re-suspended in 50  $\mu$ L molecular biology grade H<sub>2</sub>O and stored at -20 °C. Samples were diluted 1:10 and 1:100 prior to amplification. The ITS region was amplified with primers ITS4 and ITS5 (White *et al.* 1990) according to the parameters stated in CHAPTER 4 (SECTION 4.3.4.2). Amplification products were electrophoresed on 1 % agarose stained with 0.5 mg.mL<sup>-1</sup> EtBr and viewed under UV light.

The band corresponding to the ITS region was extracted from the gel using the QIAquick Gel Extraction Kit (Qiagen) and sequenced with the PCR primers in standard half reactions using ABI PRISM<sup>®</sup> BigDye Terminator Ready Reaction Cycle Sequencing Kit mix (version 3.1) (Applied Biosystems) as detailed in CHAPTER 4 (SECTION 4.3.4.4). The final sequence was deposited with Genbank under accession number AY572490. Comparative searches of Genbank and EMBL sequence databases were completed with BLAST software version 2.2.7 (online through NCBI). The most closely matched sequences were aligned with EclustlW (online through ANGIS). Start and stop regions the ITS sequence were determined by comparison with the most closely aligned species.

## **5.4 Results**

### **5.4.1 Culture and fungal morphology**

Examination of the field specimens showed multiple pycnidia embedded within the telium. Often the ostiole of the pycnidium was visible through the top of the rust telium (FIG. 5.1A), through which pycnidiospores were released in white cirrus (FIG. 5.1B). Freehand sections revealed globose to broadly ellipsoidal, unilocular pycnidia (FIG.

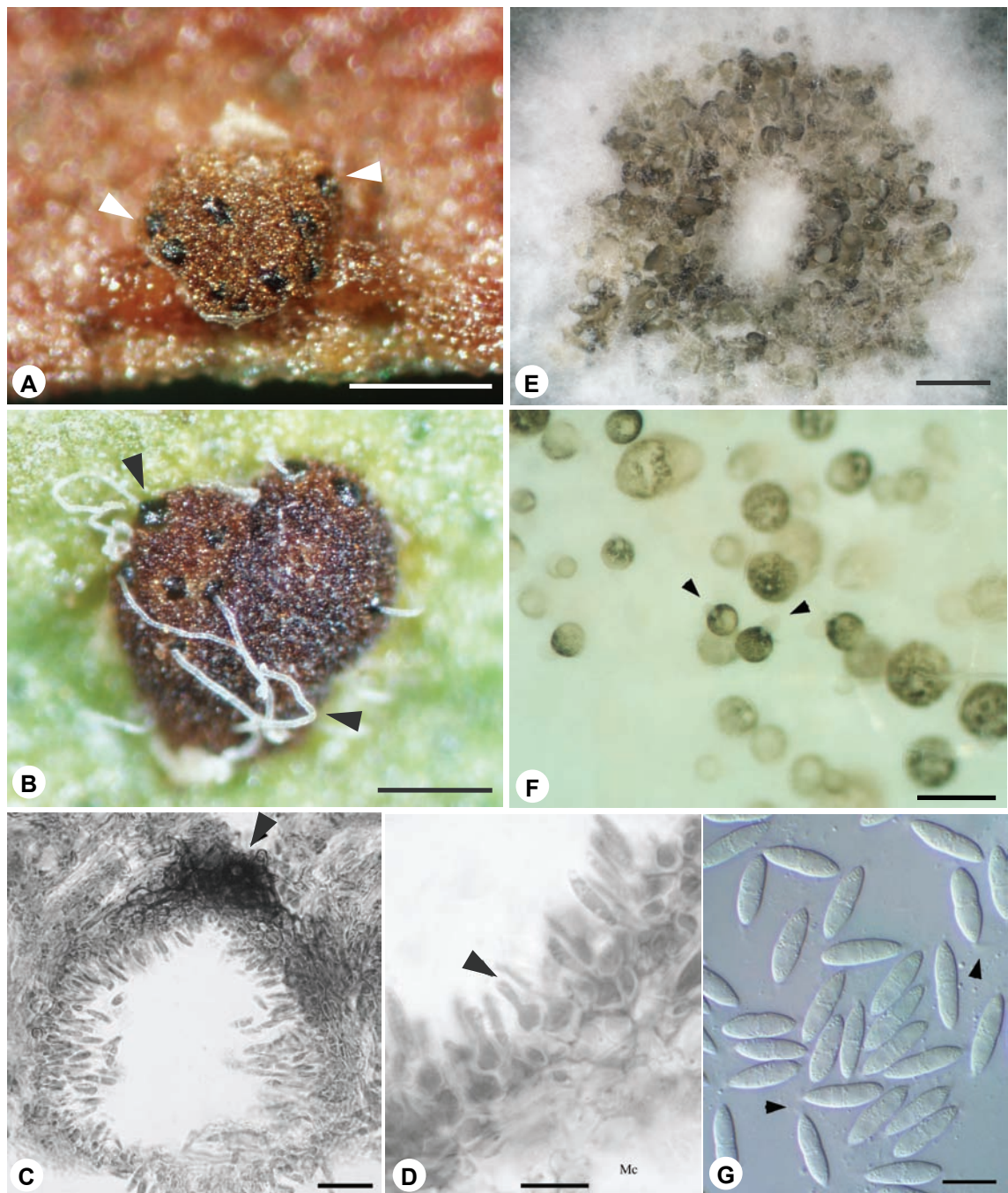
5.1C). Cells that surrounded the ostiole were dark brown to black, with cells distal from the ostiole less pigmented. Pycnidiospores were observed to form on enteroblastic conidiogenous cells lining the cavity of the pycnidium (FIG. 5.1D).

Cultures on PDA were initially white and cottony, with well-developed, branched and septate aerial mycelium (FIG. 5.1E). Abundant pycnidia developed after 6 days (FIG. 5.1F) both on the surface and immersed within the agar. Pycnidia were variable in size, 65–171  $\mu\text{m}$  in diameter with a distinct ostiole through which pycnidiospores were released in a white mucilaginous substance that became cream/pinkish in older regions of the culture. After 2–3 subcultures over a period of 3 months, the cultures no longer grew or sporulated.

Pycnidiospores were hyaline, single septate, fusiform (FIG. 5.1G) with a flaring appendage at one or both ends. Culture (PDA) derived pycnidiospores were  $13.7\text{--}19.3 \mu\text{m} \times 4.0\text{--}5.6 \mu\text{m}$  (average =  $16.0 \pm 1.1 \mu\text{m} \times 4.6 \pm 0.4 \mu\text{m}$ ;  $n = 30$ ). Field derived pycnidiospores were  $13.7\text{--}16.9 \mu\text{m} \times 4.0\text{--}5.6 \mu\text{m}$  (average =  $15.0 \pm 0.9 \mu\text{m} \times 4.6 \pm 0.4 \mu\text{m}$ ;  $n = 30$ ). No significant ( $p > 0.05$ ) difference in width between field and culture derived pycnidiospores was observed. However pycnidiospores from the PDA culture were significantly ( $p < 0.01$ ) longer than those from the field specimens. The morphology of the culture and spores agrees with the description for *Sphaerellopsis filum* (teleomorph *Eudarluca caricis*) (Sutton 1980; Sivanesan 1984).

#### 5.4.2 ITS sequence analysis

Amplification with primers ITS4 and ITS5 produced a single band of approximately 560 bp. A search of the Genbank sequence database returned a close match (99 % similarity) with two ITS sequences from *Sphaerellopsis filum* isolated from willow rusts (*Melampsora* spp.) from Germany and Ethiopia (FIG. 5.2). Close matches were also obtained from a number of Pleosporales, predominantly *Leptosphaeria maculans*.



**FIG. 5.1.** Pycnidia, culture and spore images of *Sphaerellopsis filum* infecting *Puccinia boroniae*.

**A.** Pycnidium protruding (arrows) through a telium of *P. boroniae* on the adaxial surface of a *B. heterophylla* leaf. Bar = 0.5 mm; **B.** Cirrhus exuding from the pycnidium (arrows). Bar = 0.5 mm; **C.** Freehand section of globose pycnidium surrounded by remnants of the telium. Arrow indicates darkly pigmented cells of the ostiole. Bar = 20  $\mu$ m; **D.** Conidiogenous cells and developing pycnidiospores (arrow) lining the cavity of the pycnidium. Mc = Mesophyll cell of host leaf. Bar = 10  $\mu$ m; **E.** Eleven day culture on PDA showing abundant pycnidia developing. Bar = 1 mm; **F.** Numerous pycnidia formed within the agar, clearly showing the pigmented cells surrounding each ostiole and pycnidiospores being released through the ostiole (arrows). Bar = 100  $\mu$ m; **G.** Pycnidiospores mounted in distilled  $H_2O$ . Spore appendages just out of plane of focus (arrows). Bar = 10  $\mu$ m.

				18S ◀▶ ITS1			bp
AY572490	TTTCCGTAGG	TGAACCTGCG	GAAGGATCAT	TACCTTTCTA	TCAGAAACCG	CTCTATACTC	60
AY607023			AAGGAT~AT	TACCTTTCTA	TCAGAAACCG	CTCTATACTC	38
AY572490	GGGCTTGCC	GACGTGTAAG	CGGCTGATT	CTCCCCATGT	CTTTTGCGCA	CTCTTGTTTC	120
AY607023	GGGCTTGCC	GACGTGTAAG	CGGCTGATT	CTCCCCATGT	CTTTTGCGCA	CTCTTGTTTC	98
AY572490	CTGGGCAGGC	TCGCCTGCCA	ACAGGACAAC	CTACAACCCT	TGCAATTGCA	ATCAGCGTCA	180
AY607023	CTGGGCAGGC	TCGCCTGCCA	ACAGGACAAC	CTACAACCCT	TGCAATTGCA	ATCAGCGTCA	158
				ITS1 ◀▶ 5.8S			
AY572490	GTAACAAGTA	ATTATTACAA	CTTTCAACAA	CGGATCTCTT	GGTCTGGCA	TCGATGAAGA	240
AY607023	GTAACAAGTA	ATTATTACAA	CTTTCAACAA	CGGATCTCTT	GGTCTGGCA	TCGATGAAGA	218
AY572490	ACGCAGCGAA	ATGCGATAAG	TAGTGTGAAT	TGCAGAATTC	AGTGAATCAT	CGAATCTTTG	300
AY607023	ACGCAGCGAA	ATGCGATAAG	TAGTGTGAAT	TGCAGAATTC	AGTGAATCAT	CGAATCTTTG	278
						5.8S ◀▶ ITS2	
AY572490	AACGCACATT	GCGCCCCTTG	GTATTCCATG	GGGCATGCCT	GTTCGAGCGT	CATTTGTACC	360
AY607023	AACGCACATT	GCGCCCCTTG	GTATTCCATG	GGGCATGCCT	GTTCGAGCGT	CATTTGTACC	338
AY572490	CTCAAGCTCT	GCTTGGTGTT	GGGTGTTTGT	CATACGACTC	GCCTTAAAAC	AATTGGCAGC	420
AY607023	CTCAAGCTCT	GCTTGGTGTT	GGGTGTTTGT	CATACGACTC	GCCTTAAAAC	AATTGGCAGC	398
AY572490	CGGCACGATA	GCCTGAAGCG	CAGCACATTT	TGCGCCTCTT	GCTATTGCTG	TTGGCATCCA	480
AY607023	CGGCACGATA	GCCTGAAGCG	CAGCACATTT	TGCGCCTCTT	GCTATTGCGG	TTGGCATCCA	458
				ITS2 ◀▶ 28S			
AY572490	TCAAGATCTT	TTGCTCTTGA	CCTCGGATCA	GGTAGGGATA	CCCGCTGAAC	TTAA	534
AY607023	TCAAGATCTT	TTGCTCTTGA	CCTCGGATCA	GGTAGGGATA	CCCGCTGAAC	TTAA	512

**FIG. 5.2.** Alignment of the ITS region of *Sphaerellopsis filum* isolated from *Puccinia boroniae* (gbAY572490) and its nearest match from the BLAST query, *Eudarlucacaris* (gbAY607023). Grey shaded nucleotides indicate either a gap region or nucleotide substitution.

## 5.5 Discussion

*Sphaerellopsis filum* (teleomorph *Eudarlucacaris*; syn. *Darlucacaris filum*) is a well documented mycoparasite of the Uredinales, associated with at least 369 species within 30 genera of rust fungi in more than 50 countries worldwide (Kranz and Brandenburger 1981). This is the first record of its association with *P. boroniae*, with fewer than five host rust species recorded in Australia, including *Phragmidium potentillae*, *Puccinia subnitens*, *Tranzschelia pruni-spinosae* (Kranz and Brandenburger 1981) and *Puccinia nassellae* (Briese *et al.* 2001). However, as the last detailed host list of *E. caricis* was compiled in 1981 by Kranz and Brandenburger, there may be more undocumented rust hosts present in Australia.

Pycnidiospores of *S. filum* are most often reported to infect the uredia of rust fungi (Kranz 1981). Although association with other stages such as the pycnial, aecial and telial spore stages has been reported (Carling *et al.* 1976). Little research into the host rust/mycoparasite interface on telia of rust species has been completed, though some authors have reported the inhibition of teliospore development (Kranz 1981). Kuhlman *et al.* (1978) reported a decrease in basidiospore development when *Cronartium fusiforme* telia were infected with *S. filum*.

The *Boronia* plantation at which the mycoparasite was detected on *P. boroniae* was no longer a commercially viable site; the *Boronia* plants were not maintained, with large numbers expiring during the course of the entire research project. For this reason, it was impossible to determine whether the mycoparasite was exerting a biocontrol effect on the rust pathogen as the number of rust infected plants decreased in line with the declining plant numbers. Further analysis into the interaction between *P. boroniae* and *S. filum*, including controlled infection trials, is required to confirm the pathogenicity of the mycoparasite. However, of primary concern in regard to this proposed work is the ability to maintain a viable culture of the fungus separate from its host. *S. filum* isolated from *P. boroniae* was only able to be maintained on artificial media for a relatively short period of time. A similar occurrence was reported by Liesebach and Zaspel (2004).

Though research is being completed on the use of *S. filum* as a biological control agent on willow rust (Yuan *et al.* 1998; Pei *et al.* 2003), whether or not any commercially viable product produced from this research would be applicable to an integrated pest management system in *Boronia* plantations depends on a number of factors, including the host specificity of the fungal agent. Yuan *et al.* (1999) reported *S. filum* to occur in pathogenically specialised populations, with isolates parasitising larch (*Larix kaempferi*) and blackberry (*Rubus fruticosus*) rusts failing to colonise

*Melampsora epitea* (willow rust). Nischwitz *et al.* (2005) also reported host specificity between three different isolates of *E. caricis* from *Puccinia* and *Melampsora* species. Furthermore, the application timing (prophylactic application or upon first signs of infection), the overall cost of implementing the biological agent and the resulting control level achieved on *P. boroniae* requires investigation.

---

## CHAPTER 6

### BASIDIOSPORE FORMATION, NUCLEAR BEHAVIOUR DURING TELIOSPORE GERMINATION AND COMPLETION OF THE LIFECYCLE OF *Puccinia boroniae*.



Germinating teliospore of *Puccinia boroniae*.



## 6.1 Chapter Abstract

Basidiospores of *Puccinia boroniae* formed over a temperature range of 10–25 °C, with an apparent optimal range of 15–20 ± 1 °C. There was no significant difference ( $p > 0.05$ ) between the median number of basidiospores formed at 15 and 20 °C. At 4 and 30 °C, teliospore germination was not observed. Basidiospore formation was significantly ( $p < 0.01$ ) affected by light, with telia exposed to continual darkness producing a greater number of basidiospores. Artificial inoculation of the susceptible host species *Boronia heterophylla* with basidiospores resulted in the development of telia within 21 days, confirming the microcyclic lifecycle of *P. boroniae*. No pycnia were observed prior to telia formation. Once teliospores had erupted through the leaf surface, a brief exposure (10 min) to moisture was sufficient to induce germination. Mature basidiospores were produced within 3–4 h after exposure to moisture at 15 ± 1 °C in the dark. Immature teliospores were initially binucleate undergoing karyogamy to form a single large (presumably diploid) nucleus which migrated into the developing metabasidium. Both bi- and tetranucleate metabasidia were observed, indicating that the nucleus underwent two divisions within the metabasidium prior to basidiospore formation. However, only one nuclear division was directly observed. Mature uni-, bi- and tetranucleate basidiospores were observed. Examination of the initial stages in basidiospore infection was conducted with a detached leaf assay. Appressoria were observed predominantly at the junction lines between host epidermal cells on both rust susceptible and resistant *Boronia* species. However, no infection structures beyond the early development of an intra-epidermal vesicle were observed within 36 h after inoculation with the techniques used.

## 6.2 Introduction

As biotrophic plant pathogens, the rust fungi have evolved a range of specialised infection strategies for infecting and subsequently establishing a symbiotic relationship with their host (Larous and Losel 1993; Mendgen and Deising 1993; Deising *et al.* 1996; Mendgen and Hahn 2002). These strategies may vary according to the rust species, the infective spore stage (mono- or dikaryotic) (Freitag and Mendgen 1991; Gold and Mendgen 1991; Larous and Losel 1993; Mendgen 1997) and the target host (Mendgen and Deising 1993; Heath 2002). However, the initial stages involved in forming new infection sites on host plants are fundamentally the same for each of the infective spore stages of all rust species: (i) formation and dispersal of viable infective spores (aeciospores, urediospores or basidiospores), (ii) adhesion to and germination of these spores on the host surface (Jones 1994; Staples and Hoch 1997; Tucker and Talbot 2001), and (iii) appressorium formation and penetration of the host tissue (Littlefield 1981; Staples and Hoch 1997). These early stages of infection are essential prerequisites for establishment of the fungus within the host tissue and are largely influenced by environmental conditions and the host plant itself.

The telial stage of most rust species is regarded as the survival spore stage, with the teliospores themselves incapable of infecting new hosts (Mendgen 1997). Continuation of the lifecycle first requires the formation and dispersal of infective basidiospores which develop upon germination of the teliospores. Exceptions to this exist, with some rust species forming infection hyphae during teliospore germination rather than detachable basidiospores (Hiratsuka 1973; Ono 2002a; Ono 2002b). Teliospores often exhibit inherent dormancy, making germination difficult to achieve under laboratory conditions (Mendgen 1984; Anikster 1986; Staples and Hoch 1997; Staples 2000), with external stimuli needed to induce germination (Klisiewicz 1973;

French *et al.* 1994; Bruckart and Eskandari 2002). However, teliospores of many rust species germinate without a period of dormancy.

Teliospores of *Puccinia boroniae* are capable of germinating without a period of dormancy, forming a single basidiospore from each germinating cell (CHAPTER 2). Field studies suggest that *P. boroniae* is microcyclic, with basidiospores able to be formed and released over a broad temperature range. The data also indicated a periodic night-time release, with few basidiospores captured during daylight hours (CHAPTER 4). However, inoculation of *Boronia* hosts with basidiospores of *P. boroniae* has not been successfully achieved to-date (Driessen 2001), and the effect of temperature and light on basidiospore formation has not been investigated.

Microcyclic rust species which are able to germinate immediately, such as *P. boroniae*, are capable of causing large disease epidemics under favourable conditions by the formation of numerous generations within the one growing season (Ono 2002a). A better understanding of the environmental conditions conducive for basidiospore formation, confirmation of the lifecycle of *P. boroniae*, and examination of the latent period between infection and disease expression would assist in improving management of the pathogen in commercial situations. Furthermore, though rust species are diverse in their basidial development (Hiratsuka 1973; Hiratsuka and Sato 1982; Ono 2002a), the formation of a single basidiospore as seen in *P. boroniae* is an unusual occurrence (Gardner 1987; Gardner 1994; Ono 2002a). Close examination of basidial development in *P. boroniae*, including nuclear behaviour, would contribute to the general knowledge regarding diversity of rust basidial development.

The objectives of this study were to (i) report the effect of temperature and light on basidiospore formation, (ii) examine the nuclear behaviour during teliospore germination and basidiospore formation, (iii) confirm the lifecycle of *P. boroniae* as microcyclic by successfully infecting healthy *Boronia* hosts with

basidiospores of *P. boroniae*, and (iv) examine the initial events in basidiospore infection on resistant and susceptible *Boronia* spp.

## **6.3 Material and Methods**

### **6.3.1 Specimen collection**

Telia of *P. boroniae* were collected from heavily infected *B. heterophylla* plants located at a commercial nursery in Albany (35° 01'S, 117° 50'E), Western Australia. Specimens were stored at 4 °C in brown paper bags for up to 8 weeks during which all trials were conducted. Preliminary work had shown that prolonged storage resulted in decreased viability of the teliospores and increased the levels of contaminating micro-organisms.

### **6.3.2 Effect of temperature on basidiospore formation of *Puccinia boroniae***

The effect of temperature on basidiospore formation was tested at 4, 10, 15, 20, 25 and 30 ± 1 °C. Leaves bearing telia were soaked in sterile distilled water (SDW) for 2 h at 15 ± 1 °C in the dark and blotted dry with sterile filter paper. Eight different telia were thinly hand sectioned (approximately 0.2 mm wide) into 6 sections under a dissecting microscope using a double sided razor blade. One section from each of the 8 telia was placed (sectioned side down) onto individual 2 % DWA plates, constituting one replicate. This ensured that one section from each telium was represented at each temperature. Formed basidiospores would be cast in a semi-circle around each telium section. Three replicates for each temperature were prepared (i.e. a total of 24 different telia sections incubated at each temperature). The plates were sealed and incubated in the dark at the relevant temperature.

After 24 h incubation, the number of basidiospores shed onto the DWA plate at each temperature was determined. One field of view was photographed at 100× bright field magnification from each telial section (without staining or cover slip) with a MicroPublisher 3.3 RTV photographic unit (Olympus, Australia) attached to an

Olympus BX51 microscope. The number of basidiospores in this defined area was quantified using the count function in the Olysia BioReport Imaging Software version 3.2 (Olympus, Australia). Due to the non-normal distribution of the data, differences between incubation temperatures were assessed with the non-parametric Mann-Whitney *U*-test (Townend 2002) using the program SPSS© (Version 12.0.1, SPSS Inc., Chicago). The experiment was repeated twice.

### **6.3.3 Effect of light on basidiospore formation of *Puccinia boroniae***

The effect of light on the formation of basidiospores was tested at three light intensities; in total darkness, under cool fluorescent white light and under near-UV light at  $20 \pm 1$  °C. Telial sections were prepared as described in above (SECTION 6.3.2), with the following modifications. Six different telia were each sectioned into 3 sections. One section from each of the 6 telia was placed onto a 2 % DWA plate, constituting one replicate. Three replicates were prepared (i.e. a total of 18 different telia sections incubated at each light source). After 24 h incubation the number of basidiospores released onto the DWA was quantified as described above (SECTION 6.3.2), and analysed using a one-way ANOVA.

### **6.3.4 Teliospore germination and nuclear behaviour of *Puccinia boroniae***

#### *6.3.4.1 Basidial development over time*

Telia present on *B. heterophylla* leaves, resulting from inoculation with basidiospores of *P. boroniae* under controlled conditions (SECTION 6.4.3.1), were utilized for this experiment. The telia had not been previously exposed to moisture or extreme temperatures, with the growth cabinet kept at a constant  $20 \pm 1$  °C. Telia on the leaves were briefly soaked (10 min) in SDW and gently blotted dry with filter paper. Intact telia were then removed from the underlying plant material and placed upright on a 2 % DWA plate. Moist filter paper was attached to the lid of the Petri dish (to ensure high

humidity was retained), the plate was sealed and incubated at  $15 \pm 1$  °C in the dark. Formation of germination structures was monitored initially every 30 min for 3 h, then at hourly intervals for 8 h using 400× bright field and differential interference contrast optics (DIC) on an Olympus BH-2 microscope. A final observation was made after 24 h. Photographs were taken with an attached Olympus DP10 digital camera and edited for clarity where necessary with Adobe Photoshop® 7.0. This experiment was repeated twice.

#### 6.3.4.2 *Nuclear staining of germinating teliospores and basidiospores*

The nuclear behaviour of germinating teliospores and developing basidiospores was examined by staining germinating spores with the fluorescent stain 4', 6-diamidino-2-phenylindole.2HCl (DAPI) (product number D9542, Sigma, Australia) using a modified version of Crane *et al.* (2000b). Stored teliospores (SECTION 6.3.1) were soaked for 2 h at  $15 \pm 1$  °C, plated out onto 2 % DWA as described above (SECTION 6.3.4.1) and incubated at  $15 \pm 1$  °C for 6, 12 and 24 h. After incubation, germinating teliospores and basidiospores were gently teased from the intact telium with a fine needle under a dissecting microscope onto glass slides and stained for 30 min with several drops of  $0.2 \mu\text{g.mL}^{-1}$  DAPI dissolved in McIlvaine's buffer (0.1 M citric acid, 0.2 M dibasic sodium phosphate, pH 5.5) (Crane *et al.* 2000b). Stained material was examined immediately with an Olympus BX51 (Olympus, Australia) fluorescent microscope equipped with a U-MWU2 UV filter (BP330-385 excitation filter, BA420 emission filter and BM400 dichromic mirror) and a DIC unit. Photographs were taken with the attached Olympus DP70 photographic unit and edited for clarity where necessary with Adobe Photoshop® 7.0. Examined samples were stored up to 1 week at 4 °C in the dark without any apparent decrease in fluorescence.

### 6.3.5 Whole plant inoculation with *Puccinia boroniae* basidiospores

Several branches (up to 10 cm long) of *B. heterophylla*, heavily infected with telia, were soaked for 2 h in SDW at  $20 \pm 1$  °C in the dark. The branches with telia were blotted dry with sterile filter paper and placed among the top branches of several mature, healthy *B. heterophylla* plants (18–24 months old) to allow for natural dispersal of the basidiospores produced from the intact telia (Morin *et al.* 1993). Inoculated plants were gently misted with water, covered with thick opaque plastic bags to ensure high humidity was maintained and placed in a controlled growth cabinet maintained at  $20 \pm 1$  °C with a 12 h photoperiod. The photoperiod was set such that the first period of darkness occurred when the inoculated plants were placed into the growth cabinet; this was to allow for basidiospore formation within the first 12 h.

Plants were misted daily for two days after which the telia infected branches and plastic bags were removed, and the inoculated plants were then checked daily for signs of infection. The removed branches were immediately examined under a dissecting microscope to ensure that teliospore germination and basidiospore formation had occurred. The experiment was repeated twice. In the second set of inoculations, younger plants were used (12 months old) with 3 *B. heterophylla* and 3 *B. megastigma* plants inoculated and monitored as detailed above.

### 6.3.6 Detached leaf inoculation of resistant and susceptible *Boronia* spp. with basidiospores of *Puccinia boroniae*

Detached healthy leaves from *B. heterophylla* (rust susceptible), *Boronia* 'Lipstick' (resistant) and *B. megastigma* (susceptible) were inoculated with basidiospores of *P. boroniae*. Teliospores were induced to germinate by soaking intact telia retained on host leaves for 2 h at  $15 \pm 1$  °C in the dark and blotting dry between sterile filter paper. Under a dissecting microscope, several telia were removed from the underlying plant material and placed upright on 2 % DWA plates. Eight healthy leaves from each

*Boronia* spp. were placed directly adjacent to a telium, such that discharged basidiospores would land on the leaf surface. Four leaves were placed adaxial side up and four leaves abaxial side up on the DWA plates. Moist filter paper was attached to the lid of each Petri dish, the plates were then sealed and incubated at  $15 \pm 1$  °C in the dark. The experiment was repeated twice, with inoculated leaves removed after 24 and 36 h incubation.

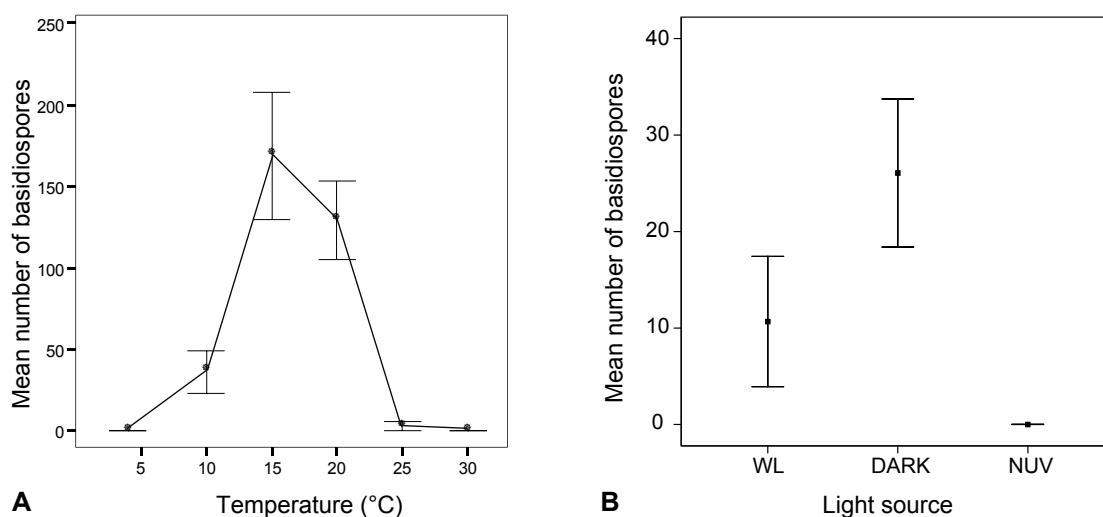
After the incubation period, the surface of the DWA surrounding each telium was examined under a dissecting microscope for the presence of discharged basidiospores. The leaves were removed and placed in a clearing solution [1:3 lactic acid (80%):absolute ethanol] for 6–12 h at 65 °C (Jackson *et al.* 2004). Cleared leaves were rinsed in tap water and stained with 0.05 % lactoglycerol cotton blue for 30 min. Leaves were rinsed twice with distilled water and mounted in glycerol with the inoculated side up. Leaves were examined for the presence of basidiospores with appressoria and intercellular infection structures at 400× and under oil at 1000× using bright field magnification on an Olympus BH-2 microscope.

## **6.4 Results**

### **6.4.1 Effect of temperature and light on basidiospore formation**

Basidiospores were formed at 10–25 °C (FIG. 6.1A) with no teliospore germination structures or basidiospores observed at 4 or 30 °C. The apparent optimal temperature for basidiospore formation was  $15\text{--}20 \pm 1$  °C, with no significant ( $p > 0.05$ ) difference observed between the median number of basidiospores formed at 15 and  $20 \pm 1$  °C. There was a significant ( $p < 0.01$ ) difference observed between the median number of basidiospores formed at 10 and  $25 \pm 1$  °C, with a higher number formed at  $10 \pm 1$  °C (FIG. 6.1A). No aberrant teliospore germination structures were observed at any of the incubation temperatures.





**FIG. 6.1.** Effect of temperature and light on basidiospore formation in *Puccinia boroniae*.

**A.** Mean number of basidiospores produced between 4 and 30 °C; **B.** Mean number of basidiospores produced at 20 °C incubated in the dark, under white light (WL) and near UV light (NUV). Error bars represent the 95 % confidence interval of the mean.

The highest number of basidiospores was formed under continuous darkness at  $20 \pm 1$  °C, with no basidiospores observed under continuous NUV light (FIG. 6.1B). Significantly ( $p < 0.01$ ) more basidiospores were produced from telia exposed to continual darkness than from telia exposed to cool-white fluorescent light. Though no basidiospores were formed under continuous NUV light exposure within the 24 h incubation period, a relatively small number of teliospores within several of the telial sections were observed forming small germ tubes.

## 6.4.2 Teliospore germination and nuclear behaviour

### 6.4.2.1 Time lapse examination of germination and basidiospore formation

Within 1–1.5 h after exposure to moisture, the first teliospore germination structures were observed. Metabasidia were apparent, extruding through the germ pore of either the apical or basal teliospore cell (FIG. 6.2A). Generally the apical cell germinated first, with synchronous germination from both the apical and basal cell of the teliospores

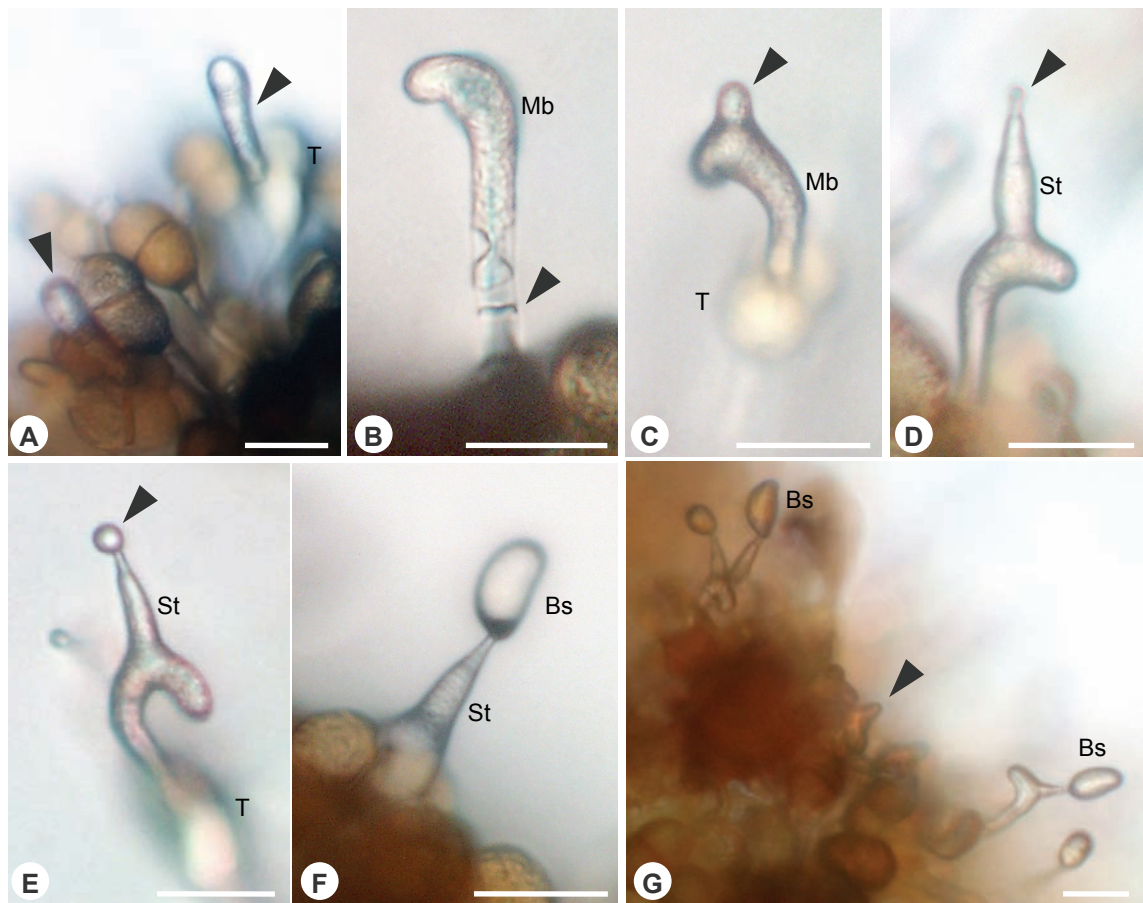
rarely observed. For teliospores high on the intact telium and not in direct contact with the 2 % DWA, these early metabasidia (and subsequent germination structures) were observed rising into the air (FIG. 6.2A).

After two hours incubation, the entire teliospore cellular contents had migrated into the elongated metabasidium (FIG. 6.2B). At this stage, metabasidia which had risen into the air were observed to curve, with a septum laid down at the proximal end either prior to or after curvature of the metabasidium had occurred (FIG. 6.2B). Within 2–3 h, a sterigma had formed, initially as a short knob like projection on the sub-terminal end of the metabasidium (FIG. 6.2C), elongating up to 20  $\mu\text{m}$  and becoming pointed at the tip (FIG. 6.2D). Basidiospore initials were also apparent during this time, developing on the end of each sterigmata (FIG. 6.2D, E).

After 3–4 h incubation, the first fully mature basidiospores were observed, present at the end of each sterigmata (FIG. 6.2F, G) and on the DWA plates, having been cast up to 0.5 mm from the edge of the telium. Within the following hour, the majority of basidiospores discharged onto the DWA agar had germinated.

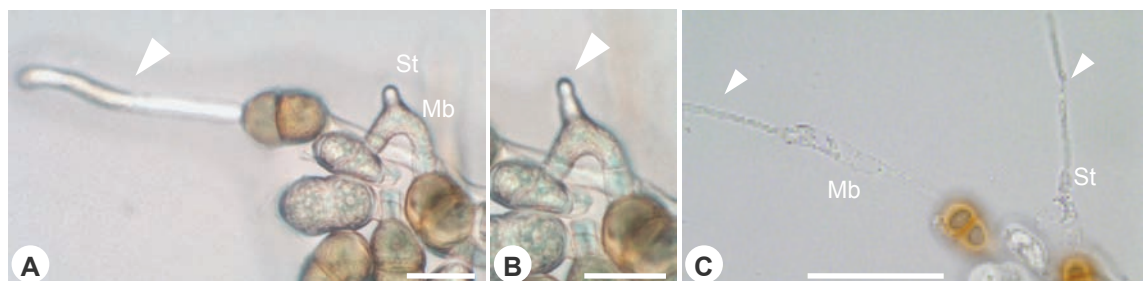
During all subsequent observation times, teliospores at various stages of germination were observed. At the end of the examination period (after 24 h), the majority of mature teliospores had germinated, with a mass of basidiospores discharged onto the DWA surface surrounding the intact telium.

Consistent and reproducible formation of a single basidiospore from each metabasidium was observed during this study. Occasionally, teliospores at the edge of each telium and therefore in direct contact with the DWA, or those which remained submerged in water, showed aberrant germination structures. These included extensive vegetative growth of the metabasidium with the formation of a hyphal like germ tube at the terminal end (FIG. 6.3A, C), or the formation of similar hyphal like germ tubes instead of a basidiospore at the terminal end of a sterigma (FIG. 6.3A–C).



**FIG. 6.2.** Time lapse examination of teliospore germination and basidiospore formation in *Puccinia boroniae* after a brief exposure to moisture (incubated at  $15 \pm 1$  °C in the dark).

**A.** 1–1.5 h. Metabasidia (arrow) developing, rising into the air from basal teliospore (T) cells; **B.** 1.5–2 h. Cell contents of the teliospore have migrated into the curving metabasidium (Mb), with a septum formed behind (arrow); **C.** 2–3 h. Knob-like projection of the sterigma (arrow) developing at the subterminal end of the metabasidium (Mb). T = teliospore; **D & E.** 2–3 h. Single sterigma (St) has elongated and formed a basidiospore initial (arrow) at its end. T = teliospore; **F&G.** 3–4 h. Mature basidiospore (Bs) attached to the sterigma (St). Earlier stages of germination are also visible, such as a immature sterigma (arrow), similar to that seen in C. Bars (all) = 20  $\mu$ m



**FIG. 6.3.** Unusual germination structures of *Puccinia boroniae*

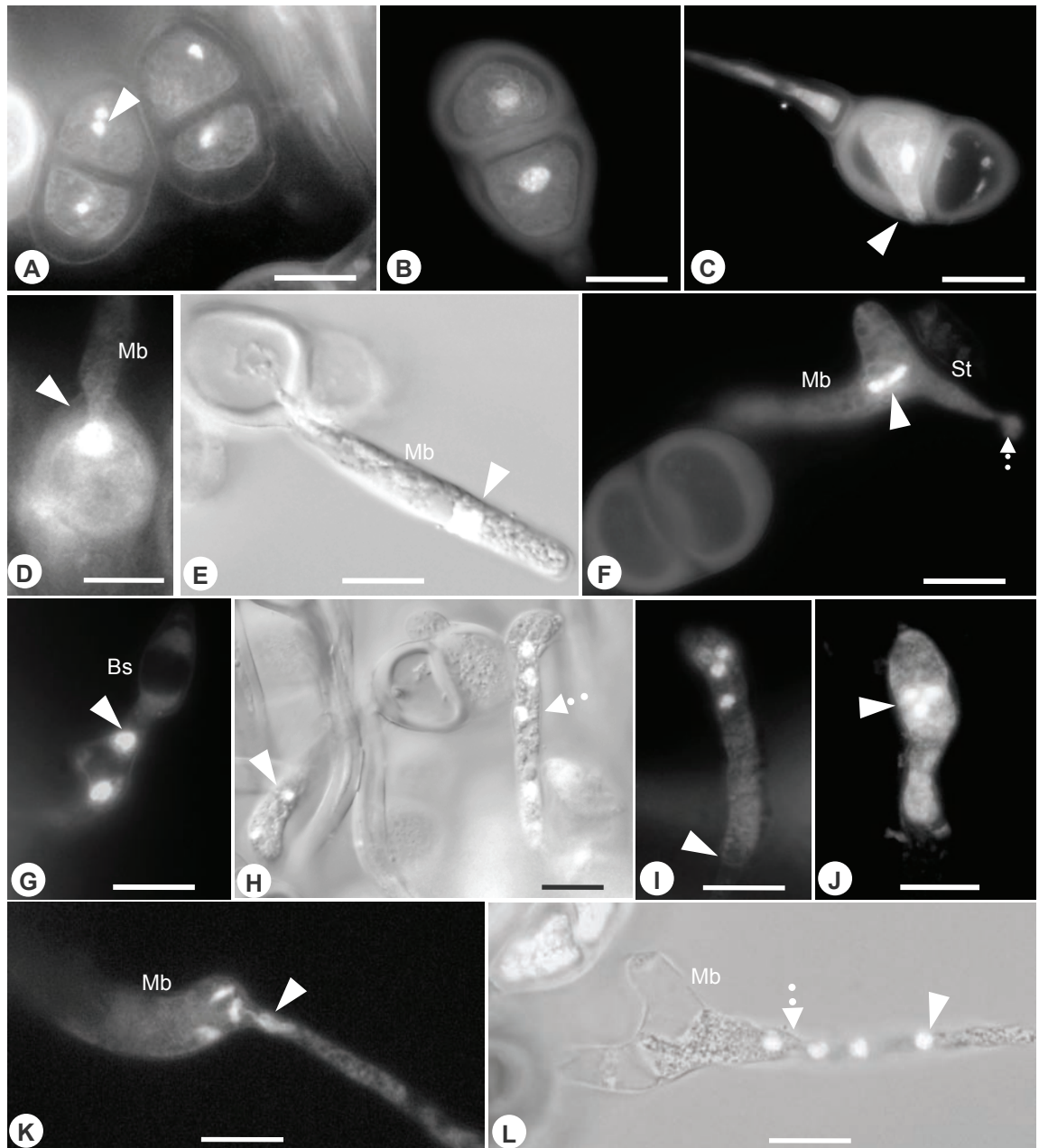
**A.** Extensive vegetative development (arrow) from a germinating teliospore and the initial formation of a sterigma (St) from a short metabasidium (Mb). Bar = 20  $\mu$ m; **B.** Formation of an apparent basidiospore initial (arrow) from the sterigma in A. Bar = 20  $\mu$ m; **C.** Elongated hyphae have developed from both the extensively long metabasidium (Mb) and the sterigma (St) in A instead of a basidiospore after 24 h incubation. Bar = 50  $\mu$ m.

#### 6.4.2.2 *Nuclear behaviour during germination and basidiospore formation*

Immature teliospores were initially binucleate (presumably haploid) (FIG. 6.4A), undergoing karyogamy to form a single large (presumably diploid) nucleus in each mature teliospore cell (FIG. 6.4B). Karyogamy did not occur simultaneously in each cell of mature teliospores, with frequent numbers of mature teliospores observed to have one cell binucleate and one uninucleate. Upon germination of the teliospores, the nucleus migrated into the developing metabasidium (FIG. 6.4C–E).

Within the metabasidium, the nucleus underwent a division, forming two nuclei (FIG. 6.4F). In addition to the binucleate metabasidia observed (FIG. 6.4G), tetranucleate metabasidia were also observed in approximately equal occurrences (FIG. 6.4H, I). This indicated that a second nuclear division had occurred, however, the point at which the nuclei divided for the second time was not captured during this experiment. A single septum, formed at the section of the metabasidium close to the teliospore cell (FIG. 6.4I), grouped all nuclei into the one cell of the metabasidium. The timing of the divisions of the nucleus in relation to the formation of the basidiospore was inconsistent. Several observations showed the formation of a basidiospore initial prior to the first division (FIG. 6.4F, G), with other observations showing the presence of a series of four smaller nuclei prior to sterigma formation (FIG. 6.4H, I).

It appeared that in tetranucleate metabasidia, all four nuclei migrated into the basidiospore (FIG. 6.4J). However, in most instances, migration of the nuclei from the metabasidium into the basidiospore was not observed. The exception to this was when a long hyphal-like germ tube was formed on the sterigma instead of a basidiospore, or directly from the metabasidium in place of the sterigma. In these instances, possibly due to the fact that the germ tube was not detachable like a basidiospore, all nuclei were observed to migrate into germ tube (FIG. 6.4K, L).

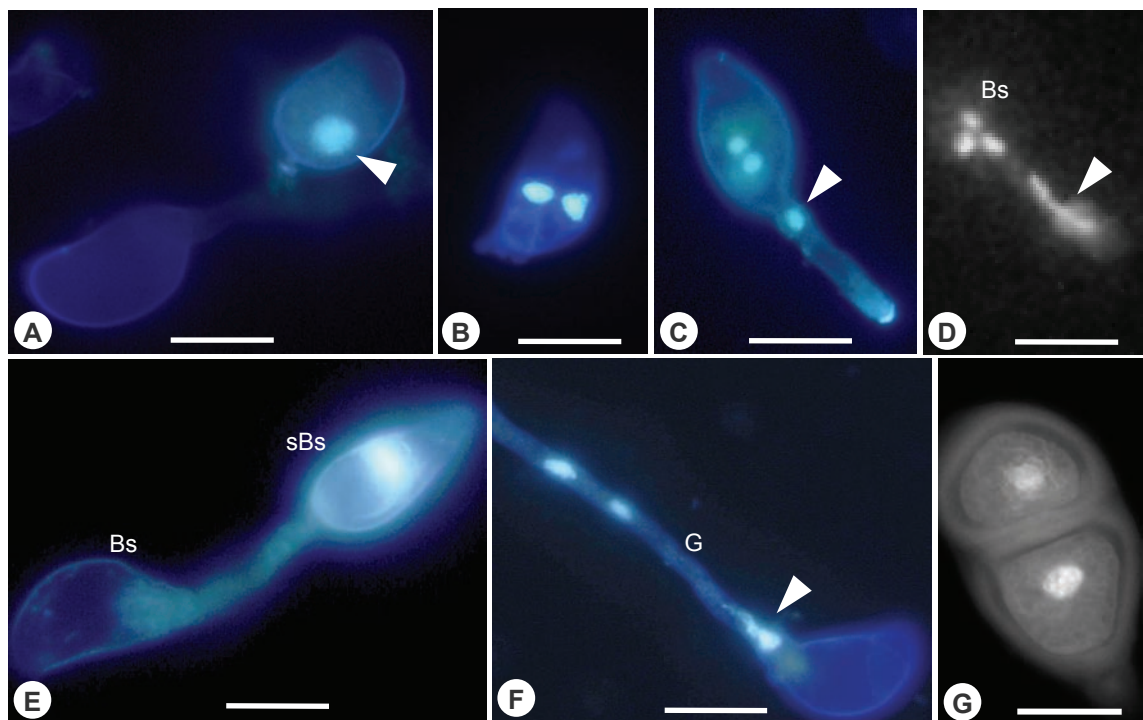


**FIG. 6.4.** DAPI stained nuclei of *Puccinia boroniae* teliospores during germination. (Note: A–G and I–L at same magnification).

**A.** Immature binucleate ( $n+n$ ) teliospores (arrow). Second nuclei of other cells out of plane of focus; **B.** Mature uninucleate teliospore ( $2n$ ); **C.** Germinating basal cell of teliospore showing single (diploid) nucleus and movement of cytoplasmic contents through the germ pore (arrow). The apical cell is empty, having already germinated; **D.** Nucleus (diploid) (arrow) moving into developing metabasidium (Mb); **E.** Uninucleate (arrow) aseptate basidium. A small amount of cytoplasmic contents still present in the basal cell; **F.** Nucleus (diploid) undergoing division in the metabasidium (Mb). A sterigma (St) and a basidiospore initial (broken arrow) have been formed; **G.** Binucleate metabasidium with basidiospore (Bs) attached. Upper nucleus appears to be migrating into the sterigma (arrow); **H.** Binucleate (arrow) and tetranucleate (broken arrow) metabasidia; **I.** Tetranucleate metabasidium. Arrow indicates septum; **J.** Tetranucleate basidiospore (arrow) attached to sterigma. One nucleus out of plane of focus; **K.** Unusual formation of a hyphal-like germ tube instead of a basidiospore at the distal end of the tetranucleate metabasidium (Mb). One nucleus is seen migrating into the germ tube (arrow); **L.** Similar to **K**, with all four nuclei migrating into the hyphal-like germ tube (arrow) from the metabasidium (Mb). Broken arrow indicates the end point of the sterigma. Bars (all) = 10  $\mu$ m.



Mature basidiospores cast from the sterigmata were variable in their nuclear status: uninucleate (FIG. 6.5A, E), binucleate (FIG. 6.5B) and tetranucleate (FIG. 6.5C, D) basidiospores were observed. Poor uptake of the fluorescent stain hindered extensive observations, with < 10 % of the basidiospores examined showing fluorescent nuclei. The nuclei of tetranucleate basidiospores appeared smaller than their uni- and binucleate counterparts (FIG. 6.5A–D), as well as the parent nucleus in mature teliospores prior to germination (FIG. 6.5G). Variation of the nuclei number in basidiospore germination structures was also observed. Binucleate and tetranucleate (FIG. 6.5F) germ tubes were commonly observed, with some germ tubes having up to eight nuclei in them.



**FIG. 6.5.** DAPI stained nuclei of *Puccinia boroniae* basidiospores cast onto the 2 % DWA. A mature uninucleate teliospore prior to germination is included to highlight the size differences of the basidiospore nuclei (note: all images are at same magnification).

**A.** Uninucleate basidiospore (arrow) adjacent to an unstained germinated basidiospore; **B.** Binucleate basidiospore; **C.** Tetranucleate basidiospore (one nucleus is out of plane of focus), showing one nucleus migrating into the germ tube (arrow); **D.** Tetranucleate basidiospore (Bs) showing one nucleus (diffuse) migrating into a developing secondary basidiospore (arrow); **E.** Uninucleate secondary basidiospore (sBs) attached to primary basidiospore (Bs); **F.** Germinating basidiospore showing two nuclei in the germ tube (G) and two migrating into the germ tube (arrow); **G.** Uninucleate teliospore prior to germination from FIG. 6.4A. Bar (all) = 10  $\mu$ m.

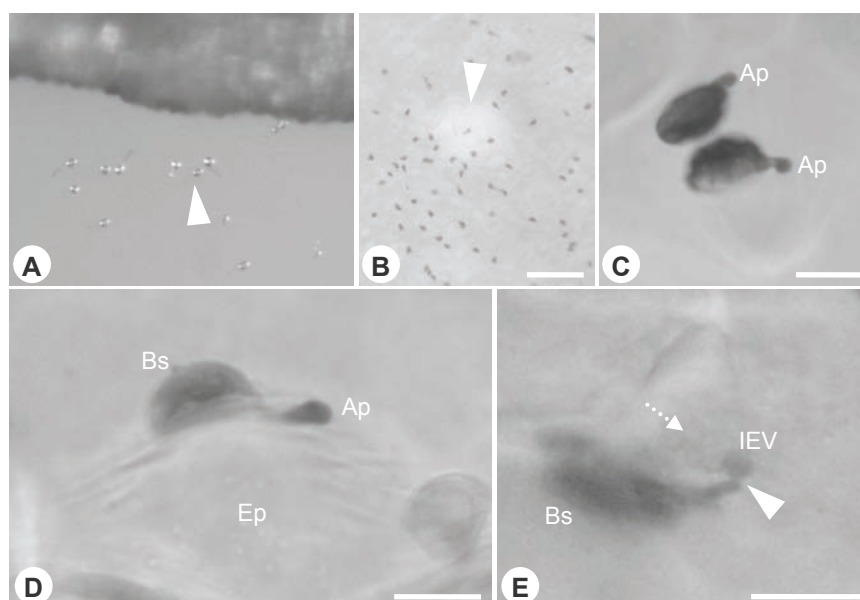
### 6.4.3 Whole plant inoculation of susceptible *Boronia* spp.

Only one *B. heterophylla* plant (18–24 months old) was successfully inoculated with *P. boroniae* basidiospores discharged from the telial inoculum, developing telia within 3 weeks from inoculation. The remaining inoculated *B. heterophylla* and *B. megastigma* remained asymptomatic for 8 weeks before the experiment was discontinued. A low level of disease development was observed on the infected *B. heterophylla* plant, with only 6 leaves on the one branch developing telia over the 8 week observation period. No pycnia were observed.

Initially, small yellow discolourations were detected on the leaves of the infected plant, 15–17 days after inoculation. These early stage telia became dark brown, rupturing through the leaf epidermis within 3–5 days. Approximately 15 telia were apparent on the 6 leaves after 3 weeks, with more telia continuing to develop over the remaining incubation period. Once the teliospores had erupted through the leaf epidermis, they were mature enough to immediately germinate after brief exposure to moisture (SECTION 6.3.4.1).

### 6.4.4 Detached leaf inoculation of resistant and susceptible *Boronia* spp.

Masses of basidiospores were successfully discharged onto the detached leaves (FIG. 6.6A,B) with the method used. On the adaxial and abaxial leaf surfaces of both the susceptible *Boronia* species (*B. heterophylla* and *B. megastigma*) and the resistant variety (*Boronia* 'Lipstick'), > 40 % of the basidiospores had formed short germ tubes ending in a visible appressorium (FIG. 6.6B, C). Appressoria appeared as slight swellings of the terminal end of the germ tube, observed predominantly at the junction lines between the epidermal cells (FIG. 6.6D). Further infection structure differentiation was not clearly visible in any of the cleared leaves. A single observation of what appeared to be the initial formation of an intraepidermal vesicle was made on the adaxial surface of a *B. heterophylla* leaf after 36 h incubation (FIG. 6.6E). A dark



**FIG. 6.6.** Cleared and stained leaves of *Boronia* spp. inoculated with basidiospores of *Puccinia boroniae*.

**A.** Detached leaf of *B. heterophylla* on DWA plate showing discharged basidiospores near the leaf, most of which have germinated; **B.** Numerous basidiospores discharged onto the adaxial surface of a *B. heterophylla* leaf. Arrow indicates a stoma. Bar = 100  $\mu\text{m}$ ; **C & D.** Germinated basidiospores (Bs) on an epidermal cell (Ep) from **B**. Each basidiospore has formed an appressorium (Ap) at the end of a short germ tube, formed in the centre of an epidermal cell (**C**) and at the junction lines between host epidermal cells (**D**); **E.** Germinated basidiospore with an apparent short penetration peg (arrow) located at the junction between two epidermal cells, and what is believed to be a developing intraepidermal vesicle (IEV) within the cell. The host tissue surrounding the IEV appears granulated, haven taken up stain (broken arrow). This leaf specimen was incubated for 36 h. Bars (C–E) = 10  $\mu\text{m}$ .

penetration peg was observed in the junction between two epidermal cells (Fig. 6.6E), arising from the end of the basidiospore germ tube. A well developed appressorium was not observed in this instance. From the penetration peg, an ovate intraepidermal vesicle appeared to be developing. The host cell surrounding the intraepidermal vesicle appeared darkly stained and granulated.

## 6.5 Discussion

This study examined for the first time aspects of the biology of *P. boroniae*. It was conclusively shown that *P. boroniae* undergoes a microcyclic lifecycle as suggested by Hennings (1906), in which successive telial generations result from basidiospore



infection, formed during teliospore germination of the previous generation. Basidiospore formation occurred over a temperature range (10–25 °C), with an apparent optimal range of 15–20 ± 1 °C. The absence of light had a significant effect of basidiospore formation, with telia incubated under continual darkness producing maximal numbers. It was found that teliospores were capable of germinating immediately after erupting through the leaf surface upon exposure to moisture, with mature basidiospores of *P. boroniae* formed within 3–4 h under optimal conditions. The data from this study would indicate that under optimal conditions, multiple generations of telia could develop in the field within a single season when moderate temperatures are experienced and moisture is available.

During this study, the tight clumping nature of the teliospores within the sorus precluded the harvest of individual teliospores without inflicting physical damage. Therefore, the methods utilised concentrated on the formation of basidiospores produced from teliospores in situ. This was deemed to more accurately reflect the natural field situation as (i) teliospores are not dispersed from the host, and (ii) the successful formation of basidiospores rather than solely teliospore germination is the crucial stage in continuing the lifecycle of *P. boroniae*. In addition, observations of teliospore germination in the current study showed that teliospores in direct contact with the water agar and those remaining immersed in water, often produced abnormal germination structures (whip-like germ tubes instead of basidiospores or extensive vegetative growth of the metabasidium). This would limit the use of spore suspensions as a method to investigate teliospore germination. The effect of excess water on teliospore germination has been observed with other rust species (Morin *et al.* 1992a; Gardner 1994; Crane *et al.* 2000b) and is generally attributed to oxygen deprivation during germination.

### 6.5.1 Basidial stage development in *Puccinia boroniae*

Mature teliospores of *P. boroniae* germinated without a rest period as originally described by earlier authors (Hennings 1903; Sydow and Sydow 1904; McAlpine 1906) and initially reported in CHAPTER 2. It was found that teliospores that had erupted through the host tissue were mature enough to germinate: a brief exposure to moisture was sufficient to initiate germination and form mature basidiospores within 3–4 h under favourable conditions. This short time frame from teliospore germination to basidiospore discharge has also been reported for *P. paullula* (Shaw 1991), *P. xanthii* (Morin *et al.* 1992a), *P. mesnieriana* (Anikster and Wahl 1985) together with a number of other Uredinales (Pearson *et al.* 1977; Anikster 1983; Mendgen 1984). Teliospore germination was not synchronous within the telium, with basidiospore formation occurring continuously over 24 h. Under field conditions, the sequential maturation of teliospores within the telium would suggest that basidiospore formation could be spread over days under favourable conditions as the telium matured.

Both light and temperature were observed to effect basidiospore formation in *P. boroniae*. Teliospore germination occurred at 10–25 °C with no germination observed at 4 or 30 °C. Basidiospores were also formed across the same temperature range with the apparent optimal temperature range of 15–20 °C. A significant difference between the number of basidiospores formed at 10 and 25 °C was also concluded. This would indicate that lower temperatures (i.e. 10–20 °C) are more conducive for basidiospore formation and that the specific optimal temperature may actually occur somewhere between 10–15 °C.

The temperature range for teliospore germination reported in this study is similar to that detailed for other Uredinales. Anikster (1986) reports teliospore germination from 27 rust species occurring between 12 and 25 °C, with optimal germination apparent at 16–18 °C. However, no reference to subsequent basidiospore formation was

made. Morin *et al.* (1992a) found that basidiospore formation in *P. xanthii* occurred over a narrower range (10–28 °C) than teliospore germination (4–38 °C). A similar occurrence is reported for *Gymnosporangium juniperi-virginianae* by Pearson *et al.* (1977), where teliospores germinated between 8–30 °C, but basidiospore formation was between 8–26 °C. In the current study of *P. boroniae*, no ‘wasted’ teliospore germination was observed, with basidiospores formed at each temperature where teliospore germination had occurred. Repetition of the experiment with smaller temperature intervals may, however, reveal differences.

The influence of light on teliospore germination and basidiospore formation is variable among the Uredinales (Mendgen 1984; Anikster 1986). Formation of *P. boroniae* basidiospores in the present study occurred under both continual darkness and cool-white fluorescent light, however telia exposed to continual darkness produced significantly higher numbers. Continual exposure to NUV light inhibited both teliospore germination and basidiospore formation over the same period of incubation. This is in contrast to other Uredinales such as *P. distincta*, *P. lagenophorae* (Weber *et al.* 1998), and *Endophyllum osteospermi* (Wood *et al.* 2004) in which NUV light stimulates teliospore germination. The effect of varying the photoperiod was not investigated during the current study. Morin *et al.* (1992a) reported that alternate light and darkness was more favourable for basidiospore formation in *P. xanthii*, a microcyclic rust, than continual darkness. This aspect of basidial development in *P. boroniae* requires further investigation.

The data presented in this study of the biology of *P. boroniae* in correlates well with the data obtained during the field trials (CHAPTER 4). Under field conditions, basidiospores were captured from February–June 2004, during which the average temperature range was 14–26 °C (Feb) to 9–15 °C (Jun). Peak numbers were captured during April 2004, when the average temperature range was 11–23 °C. Basidiospore

dispersal also exhibited a distinct periodic night-time occurrence under field conditions (SECTION 4.4.2.2). This is supported by the data reported herein, in which greater numbers of basidiospores were formed under continual darkness.

A large difference between the mean number of basidiospores formed at 20 °C in the dark in the effect of temperature (mean = 129 basidiospores) and the effect of light experiment (mean = 26 basidiospores) was observed. Both experiments utilised mature telia from the same specimen, however, the effect of light experiment was completed 2–3 weeks later than the temperature experiment. This would suggest that either (i) prolonged storage at 4 °C had resulted in a decrease in teliospore viability, or (ii) that after prolonged storage teliospores of *P. boroniae* may require a longer period (> 24 h) in order to achieve full germination capacity. Longevity of teliospores can vary extensively, depending on the rust species, whether the teliospores exhibit dormancy, and the environmental conditions the specimens are exposed to (Kotwal 1970; Anikster 1986). Further examination of the effect of storage on teliospores of *P. boroniae*, including temperature extremes that may occur under field conditions, would further enhance our understanding of the survival capacity of the spores in the field when conditions are unfavourable for basidiospore formation.

#### 6.5.1.1 *Nuclear behaviour during basidial development*

The data from this study suggests that *P. boroniae* undergoes a sexual cycle, with meiosis occurring during teliospore germination and basidiospore formation. Immature teliospores were initially binucleate, with mature teliospores having a single larger nucleus in each cell. It is likely, therefore, that the large nucleus within each mature teliospore cell was diploid, the product of karyogamy of two haploid nuclei present in the immature teliospore cells as reported by other authors (Gardner 1996; Crane *et al.* 2000). Following germination of the teliospore, the diploid nucleus migrated into the

metabasidium, where it divided once or twice, to produce bi- or tetranucleate metabasidia. The metabasidium became two-celled by the formation of a septum close to the teliospore cell. The septum did not delimitate any of the nuclei present, with all nuclei clustered into the distal cell. The incidence of the nuclear division in respect to the formation of the sterigma and basidiospore initial was difficult to discern during this study, with variation in the timing present.

From the point of the first division in the nuclear cycle of *P. boroniae*, there are several possible interpretations in respect to mitosis and meiosis. However, based on the nuclei number and size within both the metabasidium and resulting basidiospores, the following are suggested: (i) The diploid nucleus present within the metabasidium completes meiosis, resulting in four smaller haploid nuclei. These haploid nuclei then migrate into the developing basidiospore, forming the tetranucleate basidiospore. (ii) Alternatively, the 1<sup>st</sup> meiotic division occurs within the metabasidium, producing the binucleate metabasidium. One or both nuclei then migrate into the developing basidiospore where the meiotic division is completed. If both nuclei move into the basidiospore, then the resulting nuclei status is the same as (i). However, if only one nucleus migrates into the basidiospore, and completes meiosis, then the resulting basidiospore has received only half of the meiotic products. In the case of the uninucleate basidiospores which contained a large nucleus similar in size to the parent within the teliospore, division may have been delayed. These uninucleate basidiospores most likely are still diploid, with meiotic division occurring within the basidiospore to return to the haploid stage.

Though binucleate and tetranucleate basidiospores have been described for many different rust species, for example *P. lantanae* (Ono 2002b), *P. allii* (Anikster *et al.* 2004), *Uromyces vignae* (Heath *et al.* 1996), and *P. smyrnii* and *P. vincae* (Agro *et al.* 1999) these are generally concluded to be the result of successive mitotic divisions of a

haploid nucleus within the basidiospore (Anikster 1983; Gold and Mendgen 1991). In the case of *P. boroniae*, the observations would suggest that the tetranucleate condition of the basidiospores is a result of meiotic division (meiotic tetrads), thereby each basidiospore having all products of meiosis. The nuclear cycle described in the current study has been suggested for few other rust fungi. Gardner (1994) reports a similar cycle for *P. rutainsulara*, another microcyclic species which produces a single basidiospore. However, he described the nuclei (2–4) within the metabasidium as products of mitotic division, with the most distal nucleus delimited by a septum. This nucleus then migrates into the basidiospore, where it undergoes meiosis to produce a tetranucleate (haploid) basidiospore. Similarly, in *Chrysomyxa weirii* (a microcyclic rust species producing two tetranucleate basidiospores from a 2-celled metabasidium) Crane *et al.* (2000) suggested that either (i) the first division is mitosis within the metabasidium, a septum separates each nucleus, and then meiosis occurs to produce the tetranucleate basidiospore, or (ii) the first division is meiotic, and the resulting tetranucleate basidiospore results from mitotic division following completion of meiosis. However, in contrast, the present study into *P. boroniae* showed all nuclei resulting from division within the metabasidium were clustered together in the one metabasidial cell distal to the teliospore. To the best knowledge of the author, this occurrence has not been reported within the literature for any other rust species (Hiratsuka 1973; Peterson 1974; Hiratsuka and Sato 1982; Ono 2002a) and may represent a new addition to the diversity of nuclear behaviour in the rust fungi.

However, the data from this study was not conclusive and further studies are needed. Alternative staining methods and more frequent sampling over a period of time during germination may unravel the nuclear cycle of *P. boroniae*. In addition, as different isolates of the same microcyclic rust species may show variant nuclear behaviour (Ono 2002a), the inclusion of more isolates of *P. boroniae* in future studies

would be prudent, in particular the telial specimen associated with pycnia as described in earlier chapters.

### **6.5.2 Completion of the lifecycle of *Puccinia boroniae***

*Puccinia boroniae* was conclusively shown to be microcyclic and by default autoecious (Hiratsuka and Sato 1982) by the formation of telia after inoculation with basidiospores. The latent period between infection and telial formation of *P. boroniae* on *B. heterophylla* under the controlled conditions described herein was approximately 3 weeks. Of primary importance to commercial growers is that during this period of time, asymptomatic plant material may be transported between plantations from commercial (or non-commercial) sources, thereby spreading the pathogen unknowingly. It was also shown that once teliospores had erupted through the leaf surface, they were mature enough to germinate upon brief exposure to moisture, producing new airborne inoculum within 3–4 h under favourable conditions. This would indicate that under favourable field conditions, light dew may be sufficient to induce germination in semi-mature telia, with the next cycle of infection occurring even before the telium is fully developed. This is very important for growers to be aware of as multiple generations of telia could quickly develop in the field within a single season. Quarantining new planting material for a period of at least three weeks should be a must for all growers.

No pycnia were observed as part of the lifecycle, but as the specimens on which pycnia were observed were not used in this study, further inoculation trials are required using different rust specimens and host species/cultivars. The primary aim of this experiment was to confirm the lifecycle of *P. boroniae* on a susceptible host. Therefore the inoculation trial was carried out with one set of experimental conditions, favourable for basidiospore formation and reflecting the temperature in the field during which telia of *P. boroniae* are generally observed. The effect of different environmental conditions on the infection and development of *P. boroniae* on *Boronia* still needs to be

investigated. To achieve this, the inoculation method needs to be improved as a low incidence and severity of disease was observed with the current method. The method of natural dispersal of basidiospores employed in this study mimics that which is found in the field, however, more concentrated and focused inoculation may be appropriate. By removing telia from infected plant material and placing these telia side up onto a solid moist medium (such as DWA plates) in a concentrated area prior to placement over the plant would result in a more focused discharge of basidiospores onto a defined area. This approach, or modified versions thereof, has been used successfully by several authors (Groth and Mogen 1978; Kropp *et al.* 1996; Yehuda *et al.* 2004). Allowing the teliospores to germinate on this solid medium for 3–6 h prior to suspending over the healthy hosts would also be advantageous. Alternatively, inoculations using basidiospore suspensions, as reported by (Morin 1992a), could be attempted.

Early development of infection structures from germinating basidiospores was assessed by detached leaf inoculation. Appressoria were observed at the terminal end of short germ tubes produced from the basidiospores present on both leaf surfaces from resistant and susceptible *Boronia* spp. These structures formed predominantly at or near the epidermal cell junctions, a similar occurrence reported for *P. thlaspeos* (Kropp *et al.* 1999), *P. xanthii* (Morin *et al.* 1992b) and other basidiospore derived infections as reviewed by Gold and Mendgen (1991). However, subsequent infection structures such as penetration pegs, intraepidermal vesicles and inter- or intracellular hyphae were not apparent in the cleared and stained leaves. In leaves removed 36 h after inoculation with basidiospores, a single observation of a penetration peg and intraepidermal vesicle (early development) in one rust susceptible leaf (*B. heterophylla*) was made. Similar studies into *P. xanthii* (Morin *et al.* 1992b) and *P. thlaspeos* (Kropp *et al.* 1999), both microcyclic rust species, showed the formation of intra- and intercellular structures in host tissue within 24 h after inoculation with basidiospores. In order to clarify the early



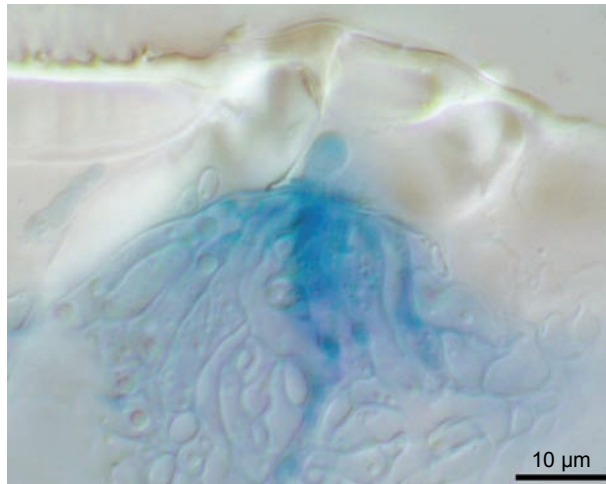
stages of infection of *P. boroniae* in rust susceptible and tolerant species, alternative clearing and staining methods, and an increased time span and interval, needs to be employed.

### **6.5.3 Conclusions**

The data from this study confirmed the microcyclic lifecycle of *P. boroniae*. The relatively broad temperature range over which basidiospores were successfully formed during this study would indicate that under a range of field temperatures, basidiospores could be continuously dispersed to initiate new generations of infection over most of the year. The *in vitro* data agreed with the field trial work (CHAPTER 4), which showed the presence of basidiospores for most of the observation period (February–August 2004), decreasing in numbers under extreme temperature (middle of summer or winter) conditions. However, several aspects of the lifecycle and biology of *P. boroniae* still require clarification, such as the effect of environmental conditions on disease development, and the role of the pycnial stage in the lifecycle.

---

**CHAPTER 7**  
**GENERAL DISCUSSION**



Hand section of pycnial primordium of *Puccinia boroniae*

## 7.1 Overview of major outcomes

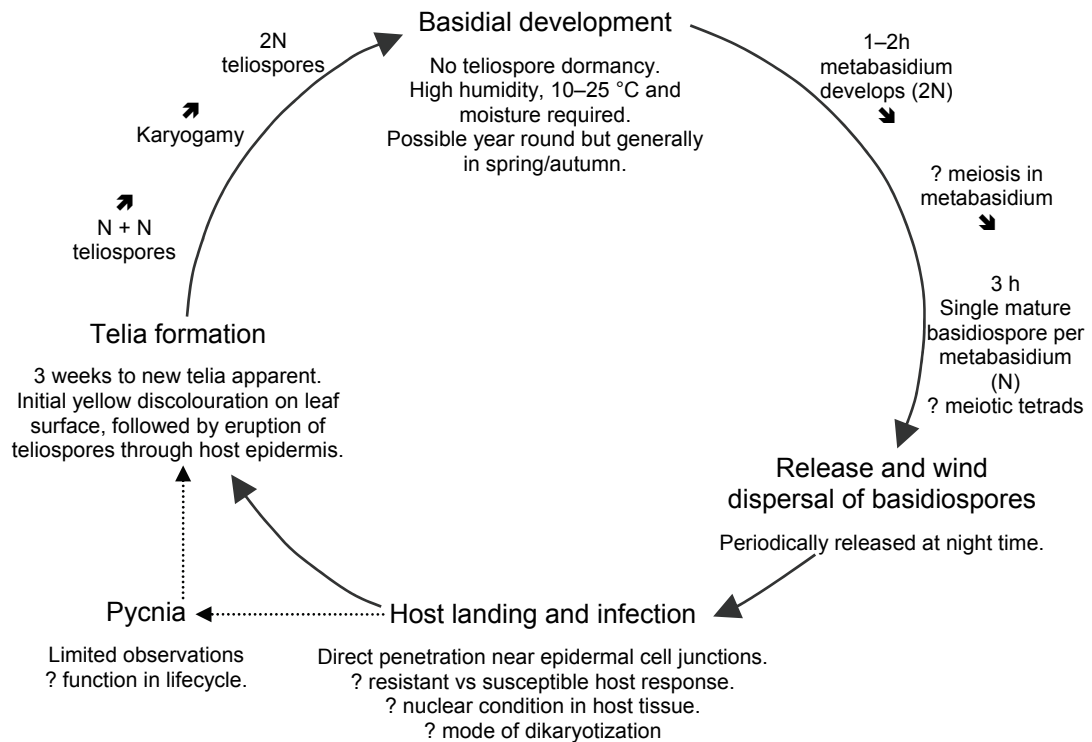
This project has made a significant contribution to our understanding about the epidemiology, biology and diversity of *P. boroniae*. Prior to this work, a lack of knowledge about this pathogen and the disease it was causing in cultivated *Boronia* was a serious hindrance to effective management of *P. boroniae*. The key findings arising from this research were:

- *P. boroniae* is a microcyclic rust fungus, producing telia and basidiospores, and on rare occasions pycnia.
- Under favourable environmental conditions, mature teliospores germinate without a period of dormancy, and can produce basidiospores within 3-4 h.
- Basidiospore dispersal occurs periodically at night, with formation and dispersal observed over most of the observation period (February–August 2004) in the southwest of Western Australia.
- The period from basidiospore infection to the development of new mature telia is relatively short (approximately 3 weeks). Due to the immediate germination capability of the teliospores, multiple generations of infection (polycyclic) may develop within a single season if the early signs of infection are not acted upon, in terms of implementing control strategies.
- A relatively low level of genetic diversity was observed in the sampled population in Western Australia. The low dispersal capacity of basidiospores together with the overall genetic homology present suggests that human transport is a primary factor in the movement of the pathogen through the major growing region.

The implications of these key findings are discussed below, with an emphasis on the management of *P. boroniae* in commercial situations.

## 7.2 Lifecycle and biology of *Puccinia boroniae*

Field and experimental studies of *P. boroniae* completed during the current study have clarified several important aspects about the lifecycle and basic biology of the rust pathogen. It was confirmed, by controlled inoculation of *Boronia heterophylla* with basidiospores of *P. boroniae*, that the lifecycle is microcyclic. The entire lifecycle is described as follows (FIG. 7.1): Initially binucleate and presumably haploid, teliospores undergo karyogamy at maturity to form uninucleate, presumably diploid cells. Under favourable conditions, these mature teliospores germinate without a period of dormancy to form mature (presumably haploid) basidiospores. These wind borne spores are dispersed to nearby plants or cast directly onto new host tissue on the same plant, where they germinate to form an appressorium and subsequently directly penetrate the host tissue. Within the host tissue, septate inter- and intracellular hyphae developed. Morphological analysis of the host/pathogen interface indicated a non-systemic mode of infection, with intracellular hyphae not observed within the vascular bundles. Intracellular hyphae morphologically resembling monokaryotic haustoria (M-haustoria) develop within the host mesophyll cells and are typically associated with infection by basidiospores (Quilliam and Shattock 2003). Within 15–17 days after successful infection by the basidiospores, immature telia are apparent and appear as yellow discolorations on the leaf surface, either flat or slightly raised on the leaf surface. Within a short period of time (3–5 days), these immature telia develop to form mature, pigmented teliospores, that rupture the epidermal layer of the host tissue. As maturation of the teliospores within the telium is asynchronous, these first mature teliospores are capable of immediate germination under favourable conditions, with the next cycle of infection occurring even before the telium is fully developed. An almost continuous release of basidiospores is possible under favourable conditions, due to the asynchronous telium development and asynchronous teliospore germination.



**FIG. 7.1** Diagrammatic illustration of the lifecycle of *Puccinia boroniae* on *Boronia* spp. in Western Australia. Comments prefaced with an ‘?’ highlight certain aspects of the biology and lifecycle not resolved during the current study.

For commercial growers, there are two major implications arising from this relatively rapid disease cycle. Firstly, the pathogen is polycyclic and under favourable environmental conditions multiple generations may form on susceptible hosts within a short period of time. In the major *Boronia* cultivation region of Western Australia, mild climatic conditions are generally experienced year round. The field and germination studies showed that basidiospores of *P. boroniae* are formed over a relatively broad temperature range (10–25 °C), with the field trials showing the presence of airborne basidiospores for most of the observation period (February–August 2004), decreasing in numbers under extreme temperature (middle of summer or winter) conditions (FIG. 7.1). Commercial species of *Boronia* are evergreen perennials, therefore photosynthetic tissue is present year round, which would enable the disease cycle of *P. boroniae* to continue indefinitely in the absence of grower intervention under these favourable

conditions. The second major implication is that during the latent period between infection and telial formation (approximately 3 weeks), asymptomatic plant material may be transported between plantations from commercial (or non-commercial) sources. Consequently growers can unknowingly spreading the pathogen to previously rust-free locations.

However, several aspects of the lifecycle and biology of *P. boroniae* still require clarification (FIG. 7.1), including: (i) the effect of environmental conditions on disease development, (ii) the initial stages of infection and host response, (iii) how the pathogen survives during environmental conditions unfavourable for reproduction, (iv) the nuclear behaviour during teliospore germination, and (v) the role of the pycnial stage in the lifecycle.

### **7.2.1 Is the pycnial stage of *Puccinia boroniae* functional in the lifecycle?**

The pycnial stage of *P. boroniae* was described for the first time during the current study, however the functional role of this spore stage in the pathogen's lifecycle remains unresolved. Pycnia were only observed on rust infected *B. megastigma* stands at the one geographical location in Western Australia. Several observations made during the field studies at this location suggest that the pycnial stage is no longer functional in the lifecycle: (i) very low numbers of pycnia were observed on relatively few infected plants in comparison to the number of telia present, (ii) mature telia were observed prior to pycnia on these infected hosts, and (iii) not all parts of the plant exhibiting telia were associated with pycnia (primarily infected stem segments).

The latter two points would indicate that the mode of dikaryotization in *P. boroniae* after infection with basidiospores is not reliant on the fertilisation of (presumably haploid) pycniospores with the flexuous hyphae to produce dikaryotic mycelium and subsequently dikaryotic teliospores (Hiratsuka 1973; Ono 2002a).

Several alternative methods of dikaryotization in microcyclic rust fungi are described by Ono (2002a) and their occurrence in these specimens of *P. boroniae* as well as those not associated with pycnia formation, needs to be investigated.

### **7.3 Variation within the population in Western Australia**

Analysis of the variation within the nuclear ribosomal RNA genes of *P. boroniae* completed in this study indicated an overall genetic uniformity within the screened population in Western Australia. The data from the ITS and IGS regions separated one group of specimens (all collected from *B. megastigma* at the Mt Barker plantation) from the remaining population. Several field based observations about these separated specimens were recorded: (i) pycnia were observed at this location, (ii) all other rust susceptible species planted out at this location remained uninfected, and (iii) certain morphological/phenotypic characteristics were different from other *P. boroniae* specimens (darker teliospore pigmentation, consistently higher mesospore numbers and preference of stem infection to leaf infection). The genetic differences together with the observational evidence have raised more questions than the current study was able to answer about the pathogen at this location. For instance, (i) is it a different (cryptic) species?, (ii) is it host/cultivar specific?, or (iii) has it simply diverged from the remaining population in Western Australia due to geographical isolation?

Morphological analysis of the teliospores of *P. boroniae* collected from *B. heterophylla* and *B. megastigma* (Driessen 2001; Driessen *et al.* 2004) which suggested that the rust infecting each host may be morphologically different, could possibly have been biased by the inclusion of two of the genetically variant specimens from the Mt Barker plantation. Re-evaluation of the data is required. Further molecular analysis, using a multi-loci approach (Bruns 2001) and expanding the specimen collection area to incorporate interstate specimens, together with host specificity

experimentation, would clarify some of the questions raised in this regard. In addition, the nuclear behaviour during teliospore germination of the single population of *P. boroniae* examined in this study may not represent what is occurring in the entire population (Ono 2002a; Ono 2002b), including these variant specimens. Further analysis may highlight differences between the specimens and contribute to our understanding of the diversity present.

In regard to the remainder of the specimens of *P. boroniae* examined during the current study, the overall genetic homology together with the low dispersal capacity of the infective basidiospores (Littlefield 1981; Gold and Mendgen 1991), suggests that human transport may be the primary factor in the movement of the pathogen through the major growing region in Western Australia. There is a window of opportunity of approximately 2–3 weeks, during which asymptomatic specimens may be transferred between plantation sites. Growers need to be aware of this possible occurrence, and (i) obtain stock from reputable commercial sources, (ii) propagate their own *Boronia* plants and restrict the movement of planting material onto their property, or (iii) keep new planting material isolated from their crop for at least a period of 3 weeks and closely inspect plants for early signs of infection prior to incorporation into their main crop.

In addition to the movement through human hands, the genetic homology present may have simply arisen as a result of the pathogen being homothallic. The majority of *P. boroniae* specimens examined in this study did not form pycnia in the field or under controlled inoculation conditions. Therefore, it is suggested that the nuclei present in each generation (after karyogamy, meiosis and dikaryotization) would likely possess the same genetic makeup. Buller (cited in Ono 2002a) suggests that the absence of pycnia in a microcyclic lifecycle indicates its homothallic nature. However, proof of the self fertility of *P. boroniae* requires the successful formation of telia from a single basidiospore inoculation as described for *Kuehneola japonica* (Ono 2002b) and



*P. mesnieriana* (Anikster and Wahl 1985), and it is suggested that this work be completed.

#### **7.4 Limitations of the current research**

A number of limitations were identified in the current study, these include::

- During the early part of the research period (2002–2003), low to absent levels of *P. boroniae* infection were observed in the majority of commercial plantations regularly visited. The major implication was that fresh specimens of *P. boroniae* were not continuously available for biological studies, with stored samples showing poor viability after prolonged storage (1–3 months). In addition, the lack of the pathogen in the field restricted the collection of data from the field trial to one rust season (Autumn 2004) rather than several as originally planned.
- Field trials investigating disease incidence and severity were established at only one grower location and no infection occurred during the trial period. In hindsight, establishing two field trials at different locations may have overcome this issue, however, in regard to this statement, the following clarifications must be made:
  - Initially two sites were established in March 2003 with *Boronia* seedlings propagated by the author: one in Mt Barker and one in Redmond (Albany). At the Redmond site, all established seedlings died due to continual irrigation problems, whereas at the Mt Barker site, the seedlings initially failed to grow for unknown reasons. Only the Mt Barker site was re-established in August 2003, with mature *Boronia* plants purchased from a wholesale nursery.
- The biological aspects of *P. boroniae* and the effect of environmental conditions on germination and basidiospore formation were only preliminary investigations in this research. The primary issue with doing more detailed work was the availability of suitable incubators for controlled trials.

## 7.5 Further research directions

The following points address possible future research directions:

- Expand on the biological studies into the effect of environmental conditions on teliospore germination and basidiospore formation. Factors that should be addressed include relative humidity, alternating photoperiods, and the effect of these factors together with temperature on the rate of teliospore germination and basidiospore formation.
- Investigation of the survival/longevity of the telial stage of *P. boroniae* under field conditions: Does prolonged exposure to non-favourable conditions such as extreme temperatures reduce the viability of the teliospores? How and where (as telia in the leaf litter or as dormant mycelium in the host tissue) does the pathogen survive during these periods?
- Continue monitoring the field trial at Mt Barker to establish whether disease is observed in subsequent years on the trap plants.
- Examine alternative inoculation methods such that (i) host pathogenicity trials may be conducted, (ii) the effect of environmental conditions on disease development may be investigated under controlled conditions, (iii) allow for a screening process for rust susceptibility of new market selections of *Boronia*, and (iv) examination of the role of pycnia in the lifecycle.
- Further work on the nuclear behaviour of other specimens of *P. boroniae*.
- Continue the genetic studies into diversity of *P. boroniae*, using alternative gene regions and expanding the sample collection area to incorporate interstate specimens. Comparative studies including other microcyclic rusts in which Rutaceae is a host, such as *P. correae* and *P. eriostemonis* (McAlpine 1906), would

also be of value in improving our knowledge regarding the diversity of the Uredinales in Australia.

- Fungicide trials using the life cycle findings of the current study as the basis on which to develop and implement fungicide regimes.

## **7.6 Conclusions**

This study has improved our knowledge of *P. boroniae* and the disease it causes, and has laid a strong foundation for future research into several aspects of the biology, epidemiology and genetic variation of the pathogen. It has also provided relevant information about the biology and disease cycle of the pathogen that will aid commercial growers in planning their disease control methods. The following recommendations for growers are made:

1. Monitor plants for the early signs of infection (prior to fully mature telia forming), and if present:
  - a. Remove and destroy suspect plant tissue.
  - b. Immediately initiate fungicide application.
2. For prevention, fungicide application should be initiated in late summer (February) when the day time temperature drop to  $< 25\text{ }^{\circ}\text{C}$ , the night time temperatures are mild ( $10\text{--}20\text{ }^{\circ}\text{C}$ ), and moisture becomes available in the form of summer rainfall or heavy dew. During late winter (early August), fungicide application should recommence once night time temperatures have risen above  $10\text{ }^{\circ}\text{C}$  and heavy rainfall no longer prevents application of the fungicide.
3. If planting new sites or incorporating new *Boronia* plants, then:
  - a. Choose alternative rust tolerant species/varieties of *Boronia* (taking into account market acceptability).

- b. Obtain planting stock from reputable (commercial) sources and quarantine plants for at least a period of 3 weeks.
- c. Interspace rows of rust susceptible species/varieties of *Boronia* with (several) rows of rust tolerant species/varieties or alternatively with other wildflower species. This may potentially minimise the effective dispersal of basidiospores to appropriate host tissue and the spread of disease.

---

## APPENDICIES



*Glomerella cingulata* ascus  
with ascospores

## Appendix 1 *Puccinia boroniae* IGS2 sequence alignment

Boxed nucleotides indicate the primer binding sites used to amplify and sequence the IGS2 region (SECTION 3.3.3.2).

	10	20	30	40	50	60	70	80	90	100
B15	.....	.....	.....	.....	.....	.....	.....	.....	.....	.....
H10	.....	.....	.....	.....	.....	.....	.....	.....	.....	.....
H7	.....	.....	.....	.....	.....	.....	.....	.....	.....	.....
M1201T1	.....	.....	.....	.....	.....	.....	.....	.....	.....	.....
M5	.....	.....	.....	.....	.....	.....	.....	.....	.....	.....
	110	120	130	140	150	160	170	180	190	200
B15	.....	.....	.....	.....	.....	.....	.....	.....	.....	.....
H10	.....	.....	.....	.....	.....	.....	.....	.....	.....	.....
H7	.....	.....	.....	.....	.....	.....	.....	.....	.....	.....
M1201T1	.....	.....	.....	.....	.....	.....	.....	.....	.....	.....
M5	.....	.....	.....	.....	.....	.....	.....	.....	.....	.....
	210	220	230	240	250	260	270	280	290	300
B15	.....	.....	.....	.....	.....	.....	.....	.....	.....	.....
H10	.....	.....	.....	.....	.....	.....	.....	.....	.....	.....
H7	.....	.....	.....	.....	.....	.....	.....	.....	.....	.....
M1201T1	.....	.....	.....	.....	.....	.....	.....	.....	.....	.....
M5	.....	.....	.....	.....	.....	.....	.....	.....	.....	.....
	310	320	330	340	350	360	370	380	390	400
B15	.....	.....	.....	.....	.....	.....	.....	.....	.....	.....
H10	.....	.....	.....	.....	.....	.....	.....	.....	.....	.....
H7	.....	.....	.....	.....	.....	.....	.....	.....	.....	.....
M1201T1	.....	.....	.....	.....	.....	.....	.....	.....	.....	.....
M5	.....	.....	.....	.....	.....	.....	.....	.....	.....	.....
	410	420	430	440	450	460	470	480	490	500
B15	.....	.....	.....	.....	.....	.....	.....	.....	.....	.....
H10	.....	.....	.....	.....	.....	.....	.....	.....	.....	.....
H7	.....	.....	.....	.....	.....	.....	.....	.....	.....	.....
M1201T1	.....	.....	.....	.....	.....	.....	.....	.....	.....	.....
M5	.....	.....	.....	.....	.....	.....	.....	.....	.....	.....
	510	520	530	540	550	560	570	580	590	600
B15	.....	.....	.....	.....	.....	.....	.....	.....	.....	.....
H10	.....	.....	.....	.....	.....	.....	.....	.....	.....	.....
H7	.....	.....	.....	.....	.....	.....	.....	.....	.....	.....
M1201T1	.....	.....	.....	.....	.....	.....	.....	.....	.....	.....
M5	.....	.....	.....	.....	.....	.....	.....	.....	.....	.....

	610	620	630	640	650	660	670	680	690	700
B15	GTGTTGTT	GTGTTGTT	GTGTTGTT	GTGTTGTT	GTGTTGTT	GTGTTGTT	GTGTTGTT	GTGTTGTT	GTGTTGTT	GTGTTGTT
H10	.....	.....	.....	.....	.....	.....	.....	.....	.....	.....
H7	.....	.....	.....	.....	.....	.....	.....	.....	.....	.....
M1201T1	.....	.....	.....	.....	.....	.....	.....	.....	.....	.....
M5	.....	.....	.....	.....	.....	.....	.....	.....	.....	.....
	710	720	730	740	750	760	770	780	790	800
B15	GTGTTGGTT	GTATTGATT	ATGTTGTTGA	AGTGAAGTGT	GTGTTTGTAT	TGTTAGCTG	AAGTTGGTGA	GGTGGTGA	GGTGGTGA	GGTGGTGA
H10	.....	.....	.....	.....	.....	.....	.....	.....	.....	.....
H7	.....	.....	.....	.....	.....	.....	.....	.....	.....	.....
M1201T1	.....	.....	.....	.....	.....	.....	.....	.....	.....	.....
M5	.....	.....	.....	.....	.....	.....	.....	.....	.....	.....
	810	820	830	840	850	860	870	880	890	900
B15	ACATGTTGTG	ATGTTGACT	ACTTGAATTC	CAATTCAGCA	AAGTGGACCA	CAGTTGACCT	CAGACAGTCA	AATTTTCAC	TCCCTGCTATA	CTACATGGGA
H10	.....	.....	.....	.....	.....	.....	.....	.....	.....	.....
H7	.....	.....	.....	.....	.....	.....	.....	.....	.....	.....
M1201T1	.....	.....	.....	.....	.....	.....	.....	.....	.....	.....
M5	.....	.....	.....	.....	.....	.....	.....	.....	.....	.....
	910	920	930	940	950	960	970	980	990	1000
B15	GTGCAACAC	ACCCAATTAG	TGTTTCAIC	ACACAACAA	ACAACCTGCA	TAATGAAATG	CATATTCTCI	GAGTATGCAA	AGTATGTTTA	TACATTAACA
H10	.....	.....	.....	.....	.....	.....	.....	.....	.....	.....
H7	.....	.....	.....	.....	.....	.....	.....	.....	.....	.....
M1201T1	.....	.....	.....	.....	.....	.....	.....	.....	.....	.....
M5	.....	.....	.....	.....	.....	.....	.....	.....	.....	.....
	1010	1020	1030	1040	1050	1060	1070	1080	1090	1100
B15	AGTCAGTCT	TGGAACATGA	ATTGTTTGA	CTCATGCTGG	GATTTAGACA	ACTCTGCCAA	AAGTGAAGT	CAATAGGTAC	TTTTAAGCCA	TTAGTCATGA
H10	.....	.....	.....	.....	.....	.....	.....	.....	.....	.....
H7	.....	.....	.....	.....	.....	.....	.....	.....	.....	.....
M1201T1	.....	.....	.....	.....	.....	.....	.....	.....	.....	.....
M5	.....	.....	.....	.....	.....	.....	.....	.....	.....	.....
	1110	1120	1130	1140	1150	1160	1170	1180	1190	1200
B15	TGTCCTGTTT	CAATGTTGAT	TATGTAGCTT	TTAAAAGAAG	CATACACATT	TCAAAGTAATA	ATAAGCCTTT	TTTTTGTGGG	ACTTATATAC	ATTATTTTTT
H10	.....	.....	.....	.....	.....	.....	.....	.....	.....	.....
H7	.....	.....	.....	.....	.....	.....	.....	.....	.....	.....
M1201T1	.....	.....	.....	.....	.....	.....	.....	.....	.....	.....
M5	.....	.....	.....	.....	.....	.....	.....	.....	.....	.....





```

1810      1820      1830      1840      1850      1860      1870      1880      1890      1900
.....|.....|.....|.....|.....|.....|.....|.....|.....|.....|
TCTTTTTCA CAAGTTGGG GAAATTATA AAAAAATGT CAACTTTTG AGTACAAAC TCCTTACTCA ACTTGCAAT GATTTATTT GTTGAAGGT
.....|.....|.....|.....|.....|.....|.....|.....|.....|.....|
B15
H10
H7
M1201T1
M5

1910      1920      1930      1940      1950      1960      1970      1980      1990
.....|.....|.....|.....|.....|.....|.....|.....|.....|.....|
TGAGTAGTAT CAAGTTGGG GCATCAGCTT TCATCTGGT CAAGAAAAA TGTACCTGG TTGATCCTGC CAGTAGTCAT ATGCTTGCTC
.....|.....|.....|.....|.....|.....|.....|.....|.....|.....|
B15
H10
H7
M1201T1
M5

```

## **Appendix 2 Preliminary studies into stem death in *Boronia***

### **A2.2 Introduction**

Between February and May 2004, stands of several *Boronia* spp. from two commercial flower plantations in Mt Barker (34° 34'S, 117° 46'E) and Albany (34° 96'S, 117° 98'E), Western Australia, were observed to suffer stem dieback. Though death of individual branches of *Boronia* is not uncommon, often a result of damage from chewing insects, close examination of the affected branches excluded insect damage as a possible cause. Dark (black) lesion areas were often observed on affected branches, indicating a possible fungal pathogen as the causal agent. The objective of this preliminary study was to identify any potential fungal pathogens from the affected plant material.

### **A2.3 Material and Methods**

#### **A2.3.1 Culture and fungal morphology**

Lesion areas were examined under a dissecting microscope and a small scraping of visible fruiting bodies was transferred with a sterile needle to potato dextrose agar (PDA). The branches were then sectioned with secateurs, flame sterilized with 70 % ethanol, and plated onto PDA. Cultures were incubated at  $20 \pm 1$  °C under constant cool-white fluorescent light, subcultured onto PDA after 3–5 days and re-incubated. Culture colour designations were made using colour charts from Kornerup and Wanscher (1967) or by general colour terms (e.g. grey) where applicable, on 14 day old cultures. Voucher specimens of each culture were lodged at the Western Australian Department of Agriculture Plant Pathogen Collection (WAC) (TABLE A2.1).

Squash mounts of fruiting bodies were prepared by mounting in 0.05 % aniline blue lactoglycerol or distilled water, and examined on an Olympus BH–2 microscope using bright field and differential interference contrast optics (DIC). Photographs were

obtained with an Olympus DP10 digital camera attached to the microscope. Spore measurements were determined from 10 day old cultures using Olysia BioReport Imaging Software version 3.2 (Olympus, Australia) as described previously (SECTION 5.3.2.1). The range of measurements is presented, with extremes in parentheses.

### A2.3.2 DNA extraction and ITS region analysis

Genomic DNA was extracted from mycelium of 5-day-old cultures and the ITS region amplified and sequenced according to the methods outlined in CHAPTER 5 (SECTION 5.3.2.2). Sequences were deposited with Genbank (TABLE A2.1) and a comparative search of Genbank and EMBL sequence databases was completed with BLAST software version 2.2.7 (online through NCBI).

## A2.4 Results and Discussion

Two fungal species were identified from the infected stem material, *Colletotrichum acutatum* and *C. gloeosporioides* (TABLE A2.1). Both fungal isolates identified in this study are significant pathogens in many agricultural and horticultural crops in Australia and worldwide, with wide host ranges (Irwin and Camerson 1978; Martin and Garcia-Figueres 1999; Ash and Lanoiselet 2001; Melksham *et al.* 2002; Vinnere *et al.* 2002; Wharton and Dieguez-Uribeondo 2004). Controlled inoculation trials are in progress to confirm the pathogenicity of the fungal isolates and fulfil Koch's Postulates.

**TABLE A2.1** Collection and culture details of *Colletotrichum* spp. isolated from *Boronia*.

Fungal species	Lodgement number	Host	Location	Genebank Accession #
<i>C. acutatum</i>	WAC12421	<i>B. megastigma</i>	Mt Barker	AY714051
<i>C. gloeosporioides</i>	WAC12422	<i>B. heterophylla</i> 'Millbrook'	Albany	AY714052
	WAC12423	<i>B. heterophylla</i> (unknown variety)	Albany	AY902476

**Colletotrichum acutatum (teleomorph *Glomerella acutata*)**

*Colletotrichum acutatum* was isolated from stems of *Boronia megastigma* located at a commercial wildflower plantation in Mt Barker, Western Australia. Few stands were observed to be infected, likely a result of the fungicide spraying regime in place. Blackened lesion areas were observed on effected branches, with branch(s) distal to the lesion area dead (FIG. A2.1A). Microscopic examination of the lesion area revealed bright orange acervuli fruiting structures (FIG. A2.1B) containing masses of fungal spores with or without setae present (FIG. A2.1C).

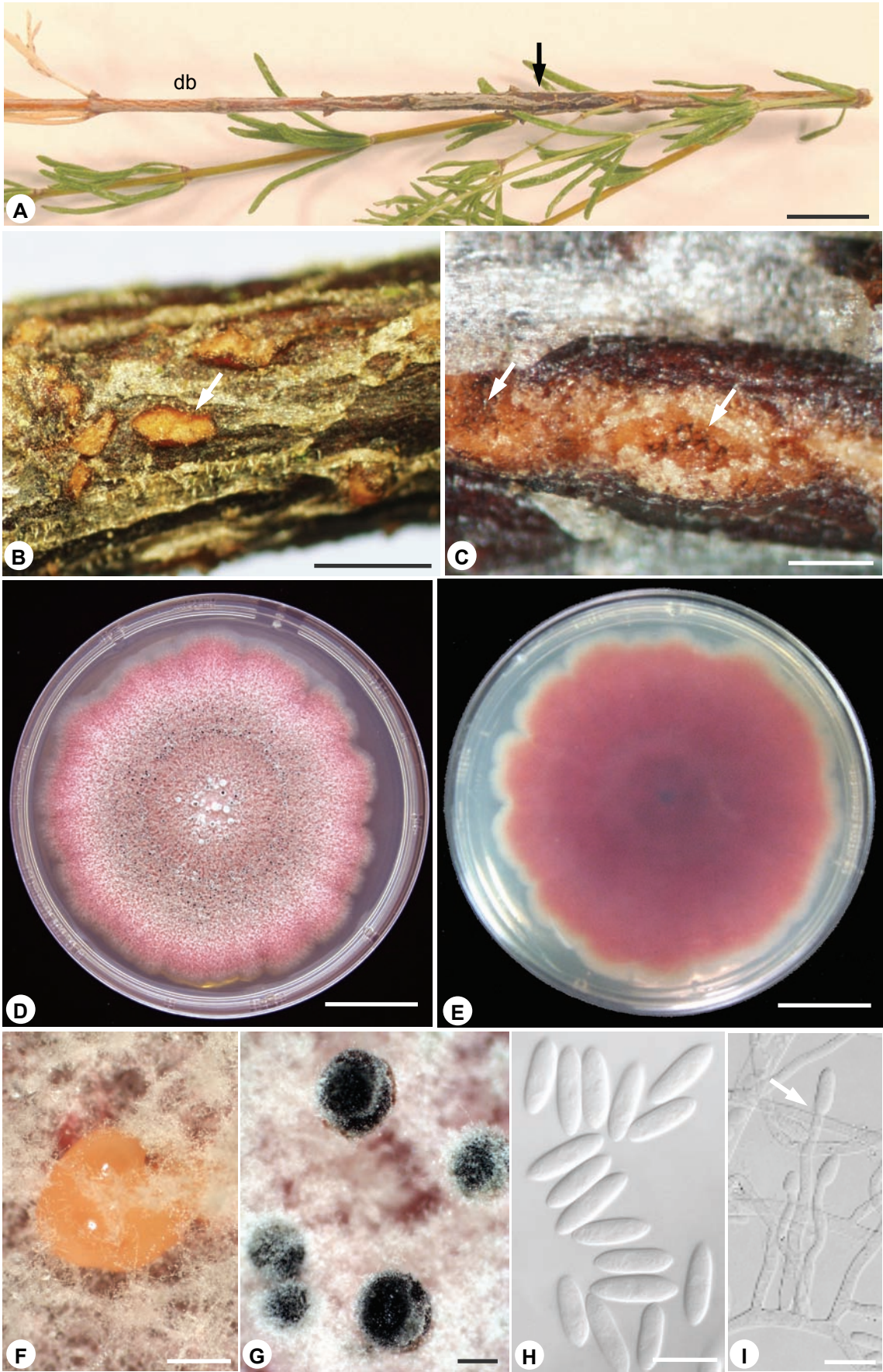
Cultures on PDA produced dense aerial mycelium, greyish rose (11B5–4) in colour, with lighter concentric bands developing from the centre (FIG. A2.1D). Reverse side of the colony was deep red (11C8) to brownish violet (11D8) (FIG. A2.1E). Bright orange conidial masses (FIG. A2.1F) developed in culture after 8 days, occasionally (but rarely) with setae present. After 12–14 days of incubation at 20 °C in the light, numerous black, sterile pycnidial-like structures were observed (FIG. A2.1G).

Conidiomatal conidia were hyaline, aseptate, cylindrical, pointed at one or both ends, (9.6–) 10.3–14.0 × 3.0–4.4 µm (average 12.2 ± 1.0 µm × 3.7 ± 0.3 µm, n = 50) (FIG. A2.1H). Abundant conidia were also formed on the aerial mycelium in addition to the conidiomatal conidia, developing from simple conidiophores (FIG. A2.1I). The teleomorph stage (*G. acutata*) was not observed in culture or on infected plant tissue.

---

**Fig. A2.1 (next page)** Symptoms and culture morphology of *Colletotrichum acutatum*.

**A.** Branch of *B. megastigma* showing black lesion area (arrow) with a dead branch (db) above the lesion point with lateral branches below the lesion area unaffected. Bar = 20 mm; **B.** Orange acervuli (arrow) containing masses of conidia on infected stem. Bar = 2 mm; **C.** Close up of acervuli with dark brown setae (arrows) visible. Bar = 0.5 mm; **D.** Front of 14 day culture on PDA. Bar = 2 cm; **E.** Reverse side of culture in **D.** Bar = 2 cm; **F.** Orange conidial mass on PDA. Bar = 1 mm; **G.** Black pycnidial-like structures formed in culture. Bar = 1 mm; **H.** Conidia from **F** mounted in distilled water. Bar = 10 µm; **I.** Aerial mycelium showing conidia developing on simple conidiophores (arrow). Bar = 20 µm.



The ITS region of *C. acutatum* was 489 bp in length, with the ITS1 and ITS2 regions 175 bp and 156 bp, respectively. Comparative searches against the Genbank database revealed 100 % similarity with several *C. acutatum* and *G. acutata* sequences; *G. acutata*, accession numbers AF272781 (Freeman *et al.* 2001), AY376501, AY376502 and AY376510 (Lubbe *et al.* 2004), and *C. acutatum*, accession number AJ301924 (Nirenberg and Feiler 2002).

***Colletotrichum gloeosporioides* (teleomorph *Glomerella cingulata*)**

Two isolates of *C. gloeosporioides* were collected from two different *B. heterophylla* varieties grown in Albany, Western Australia (TABLE A2.1). Whole branches of infected plants were dying, with large blackened lesion areas observed at the base of the infected branches (FIG. A2.2A,B). Erumpent acervuli oozing masses of salmon coloured spores with setae present were observed within the lesion area (FIG. A2.2C). Circular acervuli which had not as yet erupted through the epidermis were also observed, characterized by a bright orange centre surrounded by a dark brown/black ring (FIG. A2.2D).

Both isolates produced similar culture morphology on PDA and unless indicated, are described together. Cultures on PDA produced dense aerial mycelium, white to greyish white in colour (FIG. A2.2E). Initially conidia were produced within acervuli like structures formed with the primary cultures (FIG. A2.2F) and released in a salmon coloured ooze with setae often observed. After prolonged incubation and during subculturing, conidial masses were no longer observed, with conidia forming on simple conidiophores formed within the aerial mycelium. Conidia were hyaline, aseptate, elliptical to cylindrical, generally rounded one end and pointed at the other (FIG. A2.2G). Conidia sizes of both isolates are shown in TABLE A2.2.

**TABLE A2.2** Range of conidia and ascospores dimensions of *Glomerella cingulata* isolated from *Boronia heterophylla* varieties. Average values in square brackets

Isolate (culture collection number)	Spore dimensions ( $\mu\text{m}$ )	
	Conidia (n = 50)	Ascospores (n = 50)
WAC12422	12.6–19.8 (–23.7) $\times$ 3.5–5.3 [16.4 $\pm$ 2.2 $\times$ 4.5 $\pm$ 0.4]	12.1–17.4 (–22.4) $\times$ 3.9–5.8 (–6.6) [14.5 $\pm$ 1.6 $\times$ 4.8 $\pm$ 0.5]
WAC12423	13.3–19.8 (–21.3) $\times$ 3.7–4.9 [16.7 $\pm$ 1.9 $\times$ 4.4 $\pm$ 0.3]	13.7–21.0 (–23.9) $\times$ 4.0–5.8 [17.5 $\pm$ 1.9 $\times$ 4.8 $\pm$ 0.4]

WAC = Western Australian Department of Agriculture Plant Pathogen Collection

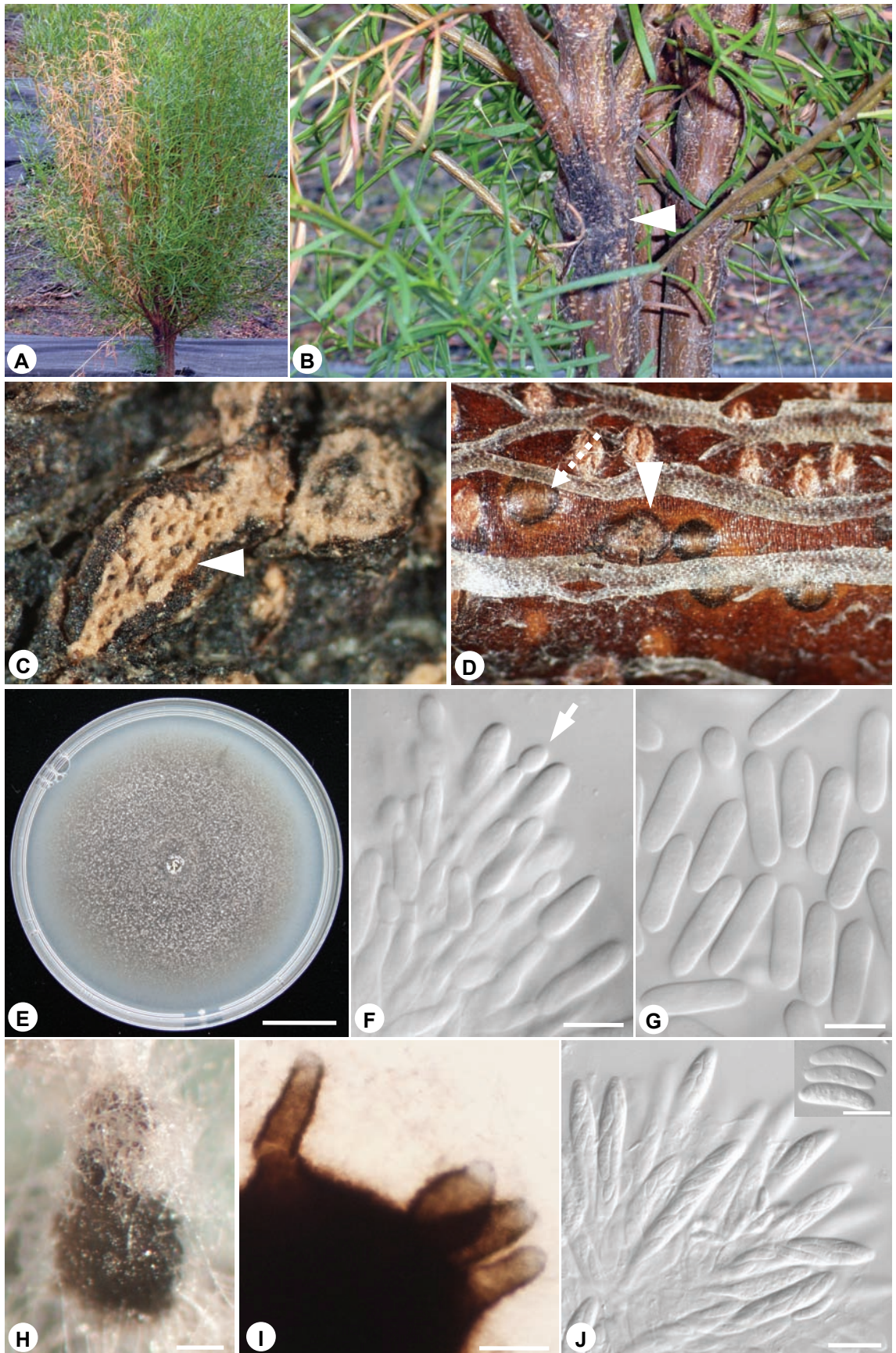
The teleomorph (*G. cingulata*) was not observed on infected hosts, however it was observed in culture after approximately 10 days. Numerous black perithecia developed on the surface or immersed in the agar, singly (FIG. A2.2H) or aggregated in groups (FIG. A2.2I). Perithecia were obpyriform, the shape and size of the ostiolar neck was variable, from inconspicuous to long. Mature asci were slightly clavate, containing 8 ascospores (FIG. A2.2J). Ascospores were hyaline, aseptate, ellipsoidal and slightly curved (FIG. A2.2J-INSERT).

The ITS region of both isolates was 100 % identical, being 481 bp in length, with the ITS1 and ITS2 regions 166 bp and 157 bp, respectively. The comparative search of Genbank revealed 99 % similarity (single base pair difference) with sequences of *C. gloeosporioides*, accession number AJ301908 (Nirenberg and Feiler 2002), and *G. cingulata* (accession number AY266394) (unpublished).

**FIG. A2.2 (next page)** Symptoms and culture morphology of *Colletotrichum gloeosporioides*.

**A.** *Boronia heterophylla* 'Millbrook' with dead branches; **B.** Close up of infected branches from **A** showing blackened lesion area at the base; **C.** Erumpent acervuli with masses of conidiospores (arrow) from lesion area depicted in **B** (isolate WAC12422); **D.** Target-like acervuli beneath the stem epidermis (dashed arrow) and exposed (arrow) (isolate WAC12423); **E.** Front of 14 day culture on PDA (isolate WAC12422). Bar = 2 cm; **F.** Conidiophores and developing conidia (arrow) from PDA culture. Bar = 10  $\mu\text{m}$ ; **G.** Conidia from spore masses mounted in distilled water. Bar = 10  $\mu\text{m}$ ; **H and I.** Perithecia of *G. cingulata* formed in culture. Bars: H = 20  $\mu\text{m}$ , I = 50  $\mu\text{m}$ ; **J.** Asci and ascospores (insert) of the teleomorph *G. cingulata* formed in culture. Bar = 20  $\mu\text{m}$  (insert = 10  $\mu\text{m}$ ).







---

**REFERENCES**

- Adam DB (1932) Rust disease in Boronia. *Journal of Agriculture, Victoria*. **30**, 389–391.
- Agrios GN (2005) 'Plant Pathology.' (Elsevier Academic Press: San Diego, USA)
- Agro LA, Bell A, Shattock RC (1999) *Puccinia smyrnii* and *P. vincae*: a microscopical study of two autoecious rusts. *Mycologist* **13**, 107–111.
- AgWA (2001) 'Australian native and south African species cultivated for the export cutflower industry of Western Australia. Planting and production results of the 1999 survey.' Department of Agriculture, Publication No. 28/2001, Perth, Western Australia.
- Anikster Y (1983) Binucleate basidiospores - a general rule in rust fungi. *Transactions of the British Mycological Society* **81**, 624–626.
- Anikster Y (1984) The *formae speciales*. In 'The Cereal Rusts'. (Eds WR Bushnell and AP Roelfs) pp. 115–130. (Academic Press, Inc.: London)
- Anikster Y (1986) Teliospore germination in some rust fungi. *Phytopathology* **76**, 1026–1030.
- Anikster Y, Szabo LJ, Eilam T, Manisterski J, Koike M, Bushnell WR (2004) Morphology, life cycle biology and DNA sequence analysis of rust fungi on garlic and chives from California. *Phytopathology* **94**, 569–577.
- Anikster Y, Wahl I (1979) Coevolution of the rust fungi on Gramineae and Liliaceae and their hosts. *Annual Review of Phytopathology* **17**, 367–403.
- Anikster Y, Wahl I (1985) Basidiospore formation and self-fertility in *Puccinia mesneriana*. *Transactions of the British Mycological Society* **84**, 164–167.
- Aoki T, K OD, Ichikawa K (2001) *Fusarium fractiflexum* sp. nov. and two other species within the *Gibberella fujikuroi* species complex recently discovered in Japan that form aerial conidia in false heads. *Mycoscience* **42**, 461–478.
- Armstrong JA (1975) The family Rutaceae. *Australian Plants* **8**, 195–236.
- Ash GJ, Brown JF (1991) Effect of nitrogen nutrition of the host on the epidemiology of *Puccinia striiformis* f.sp. *tritici* and crop yield in wheat. *Australasian Plant Pathology* **20**, 108–114.
- Ash GJ, Lanoiselet VM (2001) First report of *Colletotrichum acutatum* causing a leaf spot and hull rot of pistachio. *Australasian Plant Pathology* **30**, 365–366.
- Asnaghi C, D'Hont A, Laszmann JC, Rott P (2001) Resistance of sugarcane cultivar R570 to *Puccinia melanocephala* isolates from different geographic locations. *Plant Disease* **85**, 282–286.

- Assante G, Maffi D, Saracchi M, Farina G, Moricca S, Ragazzi A (2004) Histological studies on the mycoparasitism of *Cladosporium tenuissimum* on urediniospores of *Uromyces appendiculatus*. *Mycological Research* **108**, 170–182.
- Astarini IA, Yan G, Plummer JA (1999) Interspecific hybridisation of *Boronias*. *Australian Journal of Botany* **47**, 851–864.
- Avelino J, Willocquet L, Savary S (2004) Effects of crop management patterns on coffee rust epidemics. *Plant Pathology* **53**, 541–547.
- Ayliffe MA, Dodds PN, Lawrence GJ (2001) Characterisation of a beta-tubulin gene from *Melampsora lini* and comparison of fungal beta-tubulin genes. *Mycological Research* **105**, 818–826.
- Baka ZAM, Losel DM (1999) Ultrastructure of intercellular hyphae and haustoria of the monokaryotic stage of *Puccinia lagenophorae*. *Microbiological Research* **154**, 275–281.
- Benyon FHL, Jones AS, Tovey ER, Stone G (1999) Differentiation of allergenic fungal spores by image analysis, with application to aerobiological counts. *Aerobiologia* **15**, 211–223.
- Blaesing D, Peterson L (2002) 'Methodology and viability of re-establishing commercial *Boronia megastigma* plantations.' Rural Industries Research and Development Corporation., Publication No. 02/007, ACT, Australia.
- Bridge PD, Arora DK (1998) Interpretation of PCR methods for species definition. In 'Applications of PCR in Mycology'. (Eds PD Bridge, DK Arora, CA Reddy and RP Elander) pp. 63–81. (CAB International: Oxon)
- Briese DT, Pettit W, Anderson F (2001) 'Biological Control of Serrated Tussock and Chilean Needle Grass.' Rural Industries Research & Development Corporation, RIRDC Publication No. 01/27, Canberra, Australia.
- Brooks P (2001) 'Flower Export Statistics.' Rural Industries Research and Development, Publication No. 01/097, ACT, Australia.
- Brown JKM, Hovmøller MS (2002) Aerial dispersal of pathogens on the global and continental scales and its impact on plant disease. *Science* **297**, 537–541.
- Bruckart WL, Eskandari F (2002) Factors affecting germination of *Puccinia jaceae* var. *solstitialis* teliospores from yellow starthistle. *Phytopathology* **92**, 355–360.
- Bruckart WL, Politis DJ, Defago G, Rosenthal SS, Supkoff DM (1996) Susceptibility of *Carduus*, *Cirsium*, and *Cynara* species artificially inoculated with *Puccinia carduorum* from musk thistle. *Biological Control* **6**, 215–221.
- Bruns TD (2001) ITS reality. *Inoculum, the newsletter of the Mycological Society of America* **52**, 3–4.
- Burdon JJ, Silk J (1997) Sources and patterns of diversity in plant-pathogenic fungi. *Phytopathology* **87**, 664–669.

- Burdon JJ, Wennstrom A, Elmqvist T, Kirby GC (1996) The role of race specific resistance in natural plant populations. *Oikos* **76**, 411–416.
- Calderon C, Ward E, Freeman J, Foster SJ, McCartney HA (2002) Detection of airborne inoculum of *Leptosphaeria maculans* and *Pyrenopeziza brassicae* in oilseed rape crops by polymerase chain reaction (PCR) assays. *Plant Pathology* **51**, 303–310.
- CALM (2003) 'Management of Commercial Harvesting of Protected Flora in Western Australia 1 July 2003–30 June 2008. For submission under the Commonwealth *Environment Protection and Biodiversity Conservation Act 1999*.' Western Australian Department of Conservation and Land Management, Perth, Western Australia.
- Campbell CL (1999) The importance of dispersal mechanisms in the epidemiology of phytophthora blights and downy mildews on crop plants. *Ecosystem Health* **5**, 146–157.
- Carisse O, Philion V (2002) Meteorological factors affecting periodicity and concentration of airborne spores of *Bremia lactucae*. *Canadian Journal of Plant Pathology* **24**, 184–193.
- Carling DE, Brown MF, Millikan DF (1976) Ultrastructural examination of the *Puccinia graminis-Darluca filum* host-parasite relationship. *Phytopathology* **66**, 419–422.
- Chen LY, Price TV, Park-Ng Z (2003) Conidial dispersal by *Alternaria brassicicola* on Chinese cabbage (*Brassica pekinensis*) in the field and under simulated conditions. *Plant Pathology* **52**, 536–545.
- Ciarmela P, Potenza L, Cucchiari L, Zeppa S, Stocchi V (2002) PCR amplification and polymorphism analysis of the intergenic spacer region of ribosomal DNA in *Tuber borchii*. *Microbiological Research* **157**, 69–74.
- Clarkson JP, Kennedy R, Phelps K, Davies J, Bowtell J (1997) Quantifying the effect of reduced doses of propiconazole (Tilt) and initial disease incidence on leek rust development. *Plant Pathology* **46**, 952–963.
- Classen B, Amelunxen F, Blaschek W (2001) Ultrastructural observations on the rust fungus *Puccinia malvacearum* in *Malva sylvestris* ssp *mauritanica*. *Plant Biology* **3**, 437–442.
- Cook RP, Dubae AJ (1989) 'Host-Pathogen Index of Plant Diseases in South Australia.' (South Australian Department of Agriculture: Adelaide)
- Cooley RN (1991) The use of RFLP analysis, electrophoretic karyotyping and PCR in studies of plant pathogenic fungi. In 'Molecular Biology of Filamentous Fungi. Proceedings of the EMBO-Workshop'. (Eds U Stahl and P Tudzynski) pp. 13–25. (VCH: Berlin)
- Craig RL, Levetin E (2000) Multi-year study of *Ganoderma* aerobiology. *Aerobiologia* **16**, 78–81.
- Crane PE, Hiratsuka Y, Currah RS (2000a) Clarification of the life-cycle of *Chrysomyza woroninii* on *Ledum* and *Picea*. *Mycological Research* **104**, 581–586.

- Crane PE, Hiratsuka Y, Currah RS (2000b) Reproductive biology and evidence for water dispersal of teliospores in *Chrysomyxa weirii*, a microcyclic spruce needle rust. *Mycologia* **92**, 754–763.
- Cummins GB, Hiratsuka Y (1983) 'Illustrated genera of rust fungi.' (APS Press: Minnesota)
- De Arruda MC, Ferreira MA, Miller RN, Resende ML, Felipe MS (2003) Nuclear and mitochondrial rDNA variability in *Crinipellis pernicioso* from different geographic origins and hosts. *Mycological Research* **107**, 25–37.
- de Vallavieille-Pope C, Giosue S, Munk L, Newton AC, Niks RE, Ostergard H, Pons-Kuhnemann J, Rossi V, Sache I (2000) Assessment of epidemiological parameters and their use in epidemiological and forecasting models of cereal airborne diseases. *Agronomie* **20**, 715–727.
- Deising H, Heiler S, Rauscher M, Xu H, Mendgen K (1996) Cellular aspects of rust infection structure differentiation. In 'Histology, Ultrastructure and Molecular Cytology of Plant-Microorganism Interactions.' (Eds M Nicole and V Gianinazzi-Pearson) pp. 135–156. (Kluwer Academic Publishers: Dordrecht)
- Dillard HR, Seem RC (1990) Use of an action threshold for common maize rust to reduce crop loss in sweet corn. *Phytopathology* **80**, 846–849.
- Driessen S (2001) Genetic variation, taxonomy and pathogenicity of rust pathogen isolates (*Puccinia boroniae*) from south Western Australian Boronia cultivars. Honours PhD thesis, Murdoch University.
- Driessen SA, Hardy GESJ, O'Brien PA (2004) Diversity of *Puccinia boroniae* assessed by teliospore morphology and restriction fragment patterns of ribosomal DNA. *Australasian Plant Pathology* **33**, 77–82.
- Edel V (1998) Use of PCR and RFLP in Fungal Systematics. In 'Chemical fungal taxonomy'. (Eds JC Frisvad, PD Bridge and DK Arora) pp. 51–77. (Marcel Dekker: New York)
- Edwards J, Ades PK, Parbery DG, Halloran GM, Taylor PWJ (1999a) Morphological and molecular variation between Australian isolates of *Puccinia menthae*. *Mycological Research* **103**, 1505–1514.
- Edwards J, Halloran GM, Parbery DG, Taylor PA (1999b) Physiologic specialisation in *Puccinia menthae* on peppermint and other hosts in Victoria, Australia. *Australasian Plant Pathology* **28**, 205–211.
- Edwards J, Parbery D, Taylor PA, Halloran GM (1999c) Disease cycles of *Puccinia menthae* on commercial *Mentha* species growing in north-east Victoria, Australia. *Australasian Plant Pathology* **28**, 200–204.
- Edwards J, Taylor PA, Parbery DG, Halloran GM (1999d) Peppermint rust in Victoria: the incidence-severity relationship and its implication for the development of an action threshold. *Australian Journal of Agricultural Research* **51**, 91–95.

- Egger KN (1995) Molecular analysis of ectomycorrhizal fungal communities. *Canadian Journal of Botany* **73**, S1415–S1422.
- Ennos RA, McConnell KC (1995) Using genetic markers to investigate natural selection in fungal populations. *Canadian Journal of Botany* **73**, S302–S310.
- Finckh MR, Gacek ES, *et al.* (2000) Cereal variety and species mixtures in practice, with emphasis on disease resistance. *Agronomie* **20**, 813–837.
- Flint KM, Thomson SV (2000) Seasonal infection of the weed dyer's woad by a *Puccinia* sp rust used for biocontrol, and effects of temperature on basidiospore production. *Plant Disease* **84**, 753–759.
- Fox SL, Harder DE, Kim WK (1995) Use of virulence and length variability within the rDNA repeat unit to distinguish isolates of *Puccinia graminis* f. sp. *tritici* race QCC. *Canadian Journal of Plant Pathology* **17**, 197–204.
- Frank SA (1992) Models of plant-pathogen coevolution. *Trends in Genetics* **8**, 213–219.
- Freeman J, Ward E, Calderon C, McCartney A (2002) A polymerase chain reaction (PCR) assay for the detection of inoculum of *Sclerotinia sclerotiorum*. *European Journal of Plant Pathology* **108**, 877–886.
- Freeman S, Minz D, Maymon M, Zveibil A (2001) Genetic diversity within *Colletotrichum acutatum sensu. Simmonds*. *Phytopathology* **91**, 586–592.
- French RC, Nester SE, Binder RG (1994) Volatiles from germinating Canada thistle seed and root cuttings that stimulate germination of teliospores of the Canada thistle rust fungus, *Puccinia punctiformis*. *Journal of Agricultural and Food Chemistry* **42**, 2937–2941.
- Freytag S, Mendgen K (1991) Carbohydrates on the surface of urediniospore- and basidiospore derived infection structures of heteroecious and autoecious rust fungi. *New Phytologist* **119**, 527–534.
- Gardes M, Bruns T (1993) ITS primers with enhanced specificity for basidiomycetes-application to the identification of mycorrhizae and rusts. *Molecular Ecology* **2**, 113–118.
- Gardes M, Bruns T (1996) ITS-RFLP matching for identification of fungi. In 'Species Diagnostics Protocols: PCR and other nucleic acid methods'. (Ed. JT Clapp) pp. 177–186. (Humana Press INC.: Totowa)
- Gardner DE (1987) Teliospore germination of *Uromyces alyxiae*, an endemic Hawaiian rust. *Mycologia* **79**, 914–917.
- Gardner DE (1994) Teliospore germination and nuclear behavior of *Puccinia rutainsulara*, a microcyclic Hawaiian rust. *Mycologia* **86**, 486–493.
- Gardner DE (1996) *Puccinia rugispora* - an unusual microcyclic rust endemic to Hawaii. *Mycologia* **88**, 671–676.

- Geagea L, Huber L, Sache I, Flura D, McCartney HA, Fitt BDL (2000) Influence of simulated rain on dispersal of rust spores from infected wheat seedlings. *Agricultural & Forest Meteorology* **101**, 53–66.
- Gold RE, Littlefield LJ (1979) Light and scanning electron microscopy of the telial, pycnial, and aecial stages of *Melampsora lini*. *Canadian Journal of Botany* **57**, 629–638.
- Gold RE, Littlefield LJ, Statler GD (1979) Ultrastructure of the pycnial and aecial stages of *Puccinia recondita*. *Canadian Journal of Botany* **57**, 74–86.
- Gold RE, Mendgen K (1991) Rust basidiospore germlings and disease initiation. In 'The Fungal Spore and Disease Initiation in Plants and Animals'. (Eds GT Cole and HC Hoch) pp. 67–99. (Plenum Press: New York)
- Gomes EA, de Barros EG, Kasuya MCM, Araujo EF (1999) Molecular characterization of *Pisolithus* spp. isolates by rDNA PCR-RFLP. *Mycorrhiza* **8**, 197–202.
- Groenewoud KM, Davies NW, Menary RC (1995) Determination of propiconazole residue in Boronia extract (concrete). *Journal of Agricultural and Food Chemistry* **43**, 1230–1232.
- Groth JV, Mogen BD (1978) Completing the life cycle of *Uromyces phaseoli* var. *typica* on bean plants. *Phytopathology* **68**, 1674–1677.
- Grube M, Kroken S (2000) Molecular approaches and the concept of species and species complexes in lichenized fungi. *Mycological Research* **104**, 1284–1294.
- Guidot A, Lumini E, Debaud JC, Marmeisse R (1999) The nuclear ribosomal DNA intergenic spacer as a target sequence to study intraspecific diversity of the ectomycorrhizal basidiomycete *Hebeloma cylindrosporum* directly on *Pinus* root systems. *Applied & Environmental Microbiology* **65**, 903–909.
- Gupta PK, Varshney RK, Sharma PC, Ramesh B (1999) Molecular markers and their applications in wheat breeding. *Plant Breeding* **118**, 369–390.
- Hall TA (1999) BioEdit: a user-friendly biological sequence alignment editor and analysis program for Windows 95/98/NY. *Nucleic Acids Symposium Series* **41**, 95–98.
- Harda Y, Iwama T, Fukuda T (1996) Life cycle of *Puccinia chrysanthemi* Roze, the rust fungus on *Chrysanthemum morifolium* Ramat. *Annals of the Phytopathological Society of Japan*. **62**, 199–201.
- Harder DE, Chong J (1984) Structure and physiology of haustoria. In 'The Cereal Rusts'. (Eds WR Bushnell and AP Roelfs) pp. 431–476. (Academic Press, Inc.: London)
- Harrington TC, Rizzo DM (1999) Defining species in the fungi. In 'Structure and Dynamics of Fungal Populations'. (Ed. JJ Worrall) pp. 43–71. (Kluwer Press: Dordrecht)
- Heath MC (2002) Cellular interactions between biotrophic fungal pathogens and host or nonhost plants. *Canadian Journal of Plant Pathology* **24**, 259–264.

- Heath MC, Xu HX, Eilam T (1996) Nuclear behavior of the cowpea rust fungus during the early stages of basidiospore- or urediospore-derived growth in resistant or susceptible cowpea cultivars. *Phytopathology* **86**, 1057–1065.
- Hennings P (1903) *Puccinia boroniae*. *Hedwigia* **42**, 73.
- Henrion B, Le Tacon F, Martin F (1992) Rapid identification of genetic variation of ectomycorrhizal fungi by amplification of ribosomal RNA genes. *New Phytologist* **122**, 289–298.
- Henson JM, Fench R (1993) The polymerase chain reaction and plant disease diagnosis. *Annual Review of Phytopathology* **31**, 81–109.
- Hillis DM, Dixon MT (1991) Ribosomal DNA: Molecular evolution and phylogenetic inference. *The Quarterly Review of Biology* **66**, 411–431.
- Hiratsuka Y (1973) The nuclear cycle and the terminology of spore states in Uredinales. *Mycologia* **65**, 432–443.
- Hiratsuka Y, Sato S (1982) Morphology and taxonomy of rust fungi. In 'The Rust Fungi.' (Eds KJ Scott and AK Chakravorty) pp. 1–36. (Academic Press: New York)
- Hirst JM (1952) An automatic volumetric spore trap. *Annals of Applied Biology* **39**, 257–265.
- Ingold CT, Hudson HJ (1993) 'The Biology of Fungi.' (Chapman and Hall: London)
- Irwin JAG, Camerson DF (1978) Two diseases in *Stylosanthes* spp. caused by *Colletotrichum gloeosporioides* in Australia, and pathogenic specialization with one of the causal organisms. *Australian Journal of Agricultural Research* **29**, 305–317.
- Jackson SL, Maxwell A, Neumeister-Kemp HG, Dell B, Hardy GESTJ (2004) Infection, hyperparasitism and conidiogenesis of *Mycosphaerella lateralis* on *Eucalyptus globulus* in Western Australia. *Australasian Plant Pathology* **33**, 49–53.
- Jennings JM, Newton AC, Buck KW (1997) Detection of polymorphism in *Puccinia hordei* using RFLP and RAPD markers, differential cultivars, and analysis of the intergenic spacer region of rDNA. *Journal of Phytopathology* **145**, 511–519.
- Jimenez Gasco MM, Milgroom MG, Jimenez Diaz RM (2002) Gene genealogies support *Fusarium oxysporum* f. sp. *ciceris* as a monophyletic group. *Plant Pathology* **51**, 72–77.
- Jin Y, Steffenson BJ (1999) *Puccinia coronata* var. *hordei* var. nov.: morphology and pathogenicity. *Mycologia* **91**, 877–884.
- Jones EBG (1994) Fungal adhesion. *Mycological Research* **98**, 961–981.
- Jong SNd, Levesque CA, Verkley GJM, Abeln ECA, Rahe JE, Braun PG, de Jong SN (2001) Phylogenetic relationships among *Neofabraea* species causing tree cankers and bull's-eye rot of apple based on DNA sequencing of ITS nuclear rDNA, mitochondrial rDNA, and the beta-tubulin gene. *Mycological Research* **105**, 658–669.

- Kennedy R, Wakeham AJ, Byrne KG, Meyer UM, Dewey FM (2000) A new method to monitor airborne inoculum of the fungal plant pathogens *Mycosphaerella brassicicola* and *Botrytis cinerea*. *Applied and Environmental Microbiology* **66**, 2996–3003.
- Kennedy R, Wakeham AJ, Cullington JE (1999) Production and immunodetection of ascospores of *Mycosphaerella brassicicola*: ringspot of vegetable crucifers. *Plant Pathology* **48**, 297–307.
- Kim WK, Zerucha T, Klassen GR (1992) A region of heterogeneity adjacent to the 5S ribosomal RNA gene of cereal rusts. *Current Genetics* **22**, 101–105.
- Kirk PM, Cannon PF, David JC, Staplers JA (Eds) (2001) 'Ainsworth & Bisby's Dictionary of the Fungi. (9th edn).' (CABI Publishing: Wallingford, UK)
- Kiss L (2001) The role of hyperparasites in host plant-parasitic fungi relationships. In 'Biotic Interactions in Plant-Pathogen Associations.' (Eds MJ Jeger and NJ Spence) pp. 227–236. (CAB International: New York)
- Klisiewicz JM (1973) Effect of volatile substances from safflower on germination of teliospores of *Puccinia carthami*. *Phytopathology* **63**, 795.
- Knight SC, Anthony VM, *et al.* (1997) Rationale and perspectives on the development of fungicides. *Annual Review of Phytopathology* **35**, 349–372.
- Koike ST, Smith RF, Davis RM, Nunez JJ, Voss RE (2001) Characterization and control of garlic rust in California. *Plant Disease* **85**, 585–591.
- Kolnaar RW, van den Bosch F (2001) Effect of temperature on epidemiological parameters of *Puccinia lagenophorae*. *Plant Pathology* **50**, 363–370.
- Kornerup A, Wanscher JH (1967) 'Methuen Handbook of Colour.' (Methuen & Co Ltd: London)
- Kotwal SN (1970) The mode of germination of teliospores of *Puccinia heterospora*. *Current Science* **39**, 285–286.
- Kranz J (1981) Hyperparasitism of biotrophic fungi. In 'Microbial Ecology of the Phylloplane.' (Ed. JP Blakeman) pp. 327–352. (Academic Press: London)
- Kranz J (1988) Measuring plant disease. In 'Experimental Techniques in Plant Disease Epidemiology.' (Eds J Kranz and J Rotem) pp. 35–50. (Springer-Verlag: Heidelberg)
- Kranz J, Brandenburger W (1981) An amended host list of the rust parasite *Eudarlucacaricis*. *Zeitschrift für Pflanzenkrankheiten und Pflanzenschutz* **88**, 682–702.
- Kropp BR, Hansen D, Flint KM, Thomson SV (1996) Artificial inoculation and colonization of dyers woad (*Isatis tinctoria*) by the systemic rust fungus *Puccinia thlaspeos*. *Phytopathology* **86**, 891–896.
- Kropp BR, Hansen DR, Wolf PG, Flint KM, Thomson SV (1997) A study on the phylogeny of the dyers woad rust fungus and other species of *Puccinia* from crucifers. *Phytopathology* **87**, 565–571.



- Kropp BR, Hooper GR, Hansen DR, Binns M, Thomson SV (1999) Initial events in the colonization of dyer's woad by *Puccinia thlaspeos*. *Canadian Journal of Botany* **77**, 843–849.
- Kuhlman EG, Matthews FR, Tillerson HP (1978) Efficacy of *Darluca filum* for biological control of *Cronartium fusiforme* and *C. strobilinum*. *Phytopathology* **68**, 507–511.
- Kuhlman EG, Pepper WD (1994) Temperature effects on basidiospore germination and on infection of slash pine seedlings by *Cronartium quercuum* f sp *fusiforme*. *Phytopathology* **84**, 735–739.
- Kumar PPM, Maji MD, Gangwar SK, Das NK, Saratchandra B (2000) Development of leaf rust (*Peridiopsisora mori*) and dispersal of urediniospores in mulberry (*Morus* spp.). *International Journal of Pest Management* **46**, 195–200.
- Kung'u J (2004) Limitations and considerations in air sampling, sample analysis and result interpretation for airborne mould spores. *Inoculum: Newsletter of the Mycological Society of America*. **55**, 1–4.
- Kwon SI, von Dohlen CD, Anderson AJ (2001) Gene sequence analysis of an opportunistic wheat pathogen, an isolate of *Fusarium proliferatum*. *Canadian Journal of Botany* **79**, 1115–1121.
- Larous L, Losel DM (1993) Strategies of pathogenicity in monokaryotic and dikaryotic phases of rust fungi, with special reference to vascular infection. *Mycological Research* **97**, 415–420.
- Levetin E (1990) Studies on airborne basidiospores. *Aerobiologia* **6**, 177–180.
- Levetin E (1991) Identification and concentration of airborne basidiospores. *Grana* **30**, 123–128.
- Levetin E (2004) Methods for aeroallergen sampling. *Current Allergy and Asthma Reports* **4**, 376–383.
- Lidbetter J, Plummer J (2004) Boronia. In 'The New Crop Industries Handbook. RIRDC Publication No. 04/125.' (Eds S Salvin, M Bourke and T Byrne) pp. 420–427. (Rural Industries Research and Development Corporation.: Canberra, Australia)
- Liesebach M, Zaspel I (2004) Genetic diversity of the hyperparasite *Sphaerellopsis filum* on *Melampsora* willow rusts. *Forest Pathology* **34**, 293–305.
- Liew ECY, MaClean DJ, Irwin JAG (1998) Specific PCR based detection of *Phytophthora medicaginis* using the intergenic spacer region of the ribosomal DNA. *Mycological Research* **102**, 73–80.
- Littlefield LJ (1981) 'Biology of the plant rusts: an introduction.' (Iowa State University Press: Ames)

- Liu Z, Szabo LJ, Bushnell WR (1993) Molecular cloning and analysis of abundant and stage-specific mRNAs from *Puccinia graminis*. *Molecular Plant-Microbe Interactions* **6**, 84–91.
- Liyanage HD, McMillan RT, Jr., Kistler HC (1992) Two genetically distinct populations of *Colletotrichum gloeosporioides* from citrus. *Phytopathology* **82**, 1371–1376.
- Lokhande NM, Newaskar VB, Lanjewar RD (1998) Epidemiology and forecasting of leaf rust of groundnut. *Journal of Soils and Crops* **8**, 216–218.
- Longo N, Poggiolesi S, Naldini B, Tani G (2000) Penetration and early colonization in basidiospore-derived infection on needles of *Pinus pinea* L. by *Cronartium flaccidum* (Alb. et Schw.) Wint. *Caryologia* **53**, 9–29.
- Lubbe CM, Denman S, Cannon PF, Groenewald JZ, Lamprecht SC, Crous PW (2004) Characterization of *Colletotrichum* species associated with diseases of Proteaceae. *Mycologia* **96**, 1268–1279.
- MacNeil L, Kauri T, Robertson W (1995) Molecular techniques and their potential application in monitoring the microbiological quality of indoor air. *Canadian Journal of Microbiology* **41**, 657–665.
- Maffia LA, Berger RD (1999) Models of plant disease epidemics. II: Gradients of bean rust. *Journal of Phytopathology* **147**, 199–206.
- Mahuku GS, Platt HW (2002) Molecular evidence that *Verticillium albo-atrum* grp 2 isolates are distinct from *V. albo-atrum* grp1 and *V. tricorpus*. *Molecular Plant Pathology* **3**, 71–79.
- Maloy OC (1997) White pine blister rust control in North America. A Case History. *Annual Review of Phytopathology* **35**, 87–109.
- Martin MP, Garcia-Figueroles F (1999) *Colletotrichum acutatum* and *C. gloeosporioides* cause anthracnose on olives. *European Journal of Plant Pathology* **105**, 733–741.
- Mathivanan N, Kabilan V, Murugesan K (1998) Purification, characterization, and antifungal activity of chitinase from *Fusarium chlamydosporum*, a mycoparasite to groundnut rust, *Puccinia arachidis*. *Canadian Journal of Microbiology* **44**, 646–651.
- McAlpine D (1906) 'The Rusts of Australia : their Structure, Nature, and Classification.' (Government Printer: Melbourne)
- McCartney HA (2002) Recent advances in the detection of airborne inoculum of plant pathogens using molecular methods. In 'Proceedings Brighton Crop Protection Conference: Pests and Disease'. Brighton, UK pp. 401–408. (Farnham UK: British Crop Protection Council.)
- McCartney HA, Fitt BDL (1998) Dispersal of fungal plant pathogens: mechanisms, gradients and spatial patterns. In 'Plant Disease Epidemiology'. (Ed. G Jones) pp. 138–160. (Kluwer Academic Publishers: London)

- McDermott JM (1993) Gene flow in plant pathosystems. *Annual Review of Phytopathology* **31**, 353–373.
- McDonald BA, McDermott JM (1993) Population genetics of plant pathogenic fungi. *BioScience* **43**, 311–319.
- McIntosh RA, Brown GN (1997) Anticipatory breeding for resistance to rust diseases in wheat. *Annual Review of Phytopathology* **35**, 311–326.
- Melksham KJ, Weckert MA, Steel CC (2002) An unusual bunch rot of grapes in subtropical regions of Australia caused by *Colletotrichum acutatum*. *Australasian Plant Pathology* **31**, 193–194.
- Mendgen K (1984) Development and physiology of teliospores. In 'The Cereal Rusts'. (Eds WR Bushnell and AP Roelfs) pp. 375–398. (Academic Press, Inc.: London)
- Mendgen K (1997) The Uredinales. In 'The Mycota V Part B'. (Eds Carroll and Tudzynski) pp. 79–89. (Springer-Verlag: Berlin)
- Mendgen K, Deising H (1993) Infection structures of fungal plant pathogens - a cytological and physiological evaluation. *New Phytologist* **124**, 193–213.
- Mendgen K, Hahn M (2002) Plant infection and the establishment of fungal biotrophy. *Trends in Plant Science* **7**, 352–356.
- Mendgen K, Struck C, Voegelé RT, Hahn M (2000) Biotrophy and rust haustoria. *Physiological & Molecular Plant Pathology* **56**, 141–145.
- Mensah RK, Madden JL (1993) Development and application of integrated pest management program for the psyllid *Ctenarytana thysanura* on *Boronia megastigma* in Tasmania. *Entomologia experimentalis et applicata* **66**, 59–74.
- Mensah RK, Madden JL (1994) Life table and key factor studies of *Ctenarytana thysanura ferris* and *llyver* (Hemiptera, Psyllidae) on *Boronia megastigma* Nees ex Bartl (Rutaceae) in Tasmania. *Journal of the Australian Entomological Society* **33**, 353–361.
- Meredith DS (1973) Significance of spore release and dispersal mechanisms in plant disease epidemiology. *Annual Review of Phytopathology* **11**, 313–342.
- Mishra PK, Fox RTV, Culham A (2002) Restriction analysis of PCR amplified nrDNA regions revealed intraspecific variation within populations of *Fusarium culmorum*. *FEMS Microbiology Letters* **215**, 291–296.
- Mitchell AD, Walter M, Gaunt RE (1997) Image analysis of *Agaricus* basidiospores for use in systematics. *Biotechnology Techniques* **11**, 801–804.
- Moricca S, Ragazzi A, Mitchelson KR (1999) Molecular and conventional detection and identification of *Cladosporium tenuissimum* on two-needle pine rust aeciospores. *Canadian Journal of Botany* **77**, 339–347.

- Moricca S, Ragazzi A, Mitchelson KR, Assante G (2001) Antagonism of the two-needle pine stem rust fungi *Cronartium flaccidum* and *Peridermium pini* by *Cladosporium tenuissimum* in vitro and in plants. *Phytopathology* **91**, 457–468.
- Morin L, Auld BA, Brown JF (1993) Host range of *Puccinia xanthii* and postpenetration development on *Xanthium occidentale*. *Canadian Journal of Botany* **71**, 959–965.
- Morin L, Brown JF, Auld BA (1992a) Effects of environmental factors on teliospore germination, basidiospore formation, and infection of *Xanthium occidentale* by *Puccinia xanthii*. *Phytopathology* **82**, 1443–1447.
- Morin L, Brown JF, Auld BA (1992b) Teliospore germination, basidiospore formation and the infection process of *Puccinia xanthii* on *Canthium occidentale*. *Mycological Research* **96**, 661–669.
- Moricca S, Kasuga T, Mitchelson KR, Ragazzi A, Diamandis S (1996) Heterogeneity in intergenic regions of the ribosomal repeat of the pine-blister rusts *Cronartium flaccidum* and *Peridermium pini*. *Current Genetics* **29**, 388–394.
- Mortin A, Tabrett AM, Carder JH, Barbara DJ (1995) Sub-repeat sequences in the ribosomal RNA intergenic regions of *Verticillium alboatrum* and *V. dahliae*. *Mycological Research* **99**, 257–266.
- Mueller DS, Jeffers SN, Buck JW (2004) Effect of timing of fungicide applications on development of rusts on daylily, geranium, and sunflower. *Plant Disease* **88**, 657–661.
- Nagarajan S, Singh DV (1990) Long-distance dispersion of rust pathogens. *Annual Review of Phytopathology* **28**, 139–153.
- Neumeister-Kemp HG, Maxwell A, Kemp PC, Dell B, Hardy GESJ (2004) An advanced slit-type volumetric spore trap for monitoring bioaerosols; new methods for identifying fungal spores. *Australasian Plant Pathology* **33**, 393–400.
- Niks RE, Butler GM (1993) Evaluation of morphology of infection structures in distinguishing between different allium rust fungi. *Netherlands Journal of Plant Pathology* **99**, 139–149.
- Nirenberg HI, Feiler U (2002) Description of *Colletotrichum lupini* comb. nov. in modern terms. *Mycologia* **94**, 307–320.
- Nischwitz C, Newcome G, Anderson CL (2005) Host specialization of the mycoparasite *Eudarluca caricis* and its evolutionary relationship to *Ampelomyces*. *Mycological Research* **109**, 421–428.
- Ono Y (2002a) The diversity of nuclear cycle in microcyclic rust fungi (Uredinales) and its ecological and evolutionary implications. *Mycoscience* **43**, 421–439.
- Ono Y (2002b) Life cycle and nuclear behaviour in three rust fungi (Uredinales). *Mycoscience* **43**, 37–45.

- Pantou MP, Mavridou A, Typas MA (2003) IGS sequence variation, group-I introns and the complete nuclear ribosomal DNA of the entomopathogenic fungus *Metarhizium*: excellent tools for isolate detection and phylogenetic analysis. *Fungal Genetics and Biology* **38**, 159–174.
- Pataky JK, Headrick JM (1989) Management of common rust on sweet corn with resistance and fungicides. *Journal of Production Agriculture* **2**, 362–369.
- Pearson RC, Aldwinckle HS, Seem RC (1977) Teliospore germination and basidiospore formation in *Gymnosporangium juniperi-virginianae*: a regression model of temperature and time effects. *Canadian Journal of Botany* **55**, 2832–2837.
- Pecchia S, Mercatelli E, Vannacci G (1998) PCR amplification and characterization of the intergenic spacer region of the ribosomal DNA in *Pyrenophora graminea*. *FEMS Microbiology Letters* **166**, 21–27.
- Pedroza SA, Teliz OD, Torre ARdl, Campbell CL, De la Torre AR (1994) Varieties and cultural practices as management tools for multiple diseases on beans (*Phaseolus vulgaris* L.) in Puebla, Mexico. *Revista Mexicana de Fitopatologia* **12**, 146–154.
- Pei MH, Hunter T, Ruiz C, Bayon C, Harris J (2003) Quantitative inoculation of willow rust *Melampsora larici-epitea* with the mycoparasite *Sphaerellopsis filum* (teleomorph *Eudarlucia caricis*). *Mycological Research* **107**, 57–63.
- Peterson RH (1974) The rust fungus life cycle. *Botanical Review* **40**, 453–513.
- Plummer J (1997) Boronias. In 'The New Rural Industries: A handbook for farmers and investors'. RIRDC Publication No. 98/034 (Ed. K Hyde) pp. 493–499 (Rural Industries Research and Development Corporation.: Canberra, Australia)
- Plummer JA (1996) Boronia. In 'Native Australian plants horticulture and uses'. (Eds K Johnson and M Burchett) pp. 191–214. (University of New South Wales Press, Sydney, Australia)
- Poteri M, Helander ML, Saikkonen K, Elamo P (2001) Effect of *Betula pendula* clone and leaf age on *Melampsorium betulinum* rust infection in a field trial. *Forest Pathology* **31**, 177–185.
- Pramateftaki PV, Antoniou PP, Typas MA (2000) The complete DNA sequence of the nuclear ribosomal RNA gene complex of *Verticillium dahliae*: intraspecific heterogeneity within the intergenic spacer region. *Fungal Genetics and Biology* **29**, 19–27.
- Quilliam RS, Shattock RC (2003) Haustoria of microcyclic rust fungi *Uromyces ficariae* and *Puccinia tumida* and other gall-forming species, *U. dactylidis* (macrocyclic) and *P. smyrnii* (demicyclic). *Plant Pathology* **52**, 104–113.
- Rey MEC, Garnett HM (1988) Epidemiological studies of *Puccinia digitaliae* and *Phyllachora paspalicola* on grasses at Nylsvley Nature Reserve. *South African Journal of Botany* **54**, 551–557.

- Rijkenberg FHJ, Truter SJ (1973) Haustoria and intracellular hyphae in the rusts. *Phytopathology* **63**, 281–286.
- Roelfs AP (1984) Race specificity and methods of study. In 'The Cereal Rusts'. (Eds WR Bushnell and AP Roelfs) pp. 131–164. (Academic Press, Inc.: London)
- Roose-Amsaleg C, de Vallavieille-Pope C, Brygoo Y, Levis C (2002) Characterisation of a length polymorphism in the two intergenic spacers of ribosomal RNA in *Puccinia striiformis* f. sp. *tritici*, the causal agent of wheat yellow rust. *Mycological Research* **106**, 918–924.
- Rosenzweig N, Volz PA (1999) The haustoria of *Puccinia* and host cell relations. *Microbios.* **99**, 19–26.
- Sache I (2000) Short-distance dispersal of wheat rust spores by wind and rain. *Agronomie* **20**, 757–767.
- Sambrook J, Fritsch EF, Maniatis T (1989) 'Molecular cloning: a laboratory manual.' (Cold Spring Harbor Laboratory Press: Cold Spring Harbor, New York)
- Sampson PJ, Walker J (1982) 'An Annotated List of Plant Diseases in Tasmania.' (Department of Agriculture: Tasmania)
- Schweigkofler W, O'Donnell K, Garbelotto M (2004) Detection and quantification of airborne conidia of *Fusarium circinatum*, the causal agent of pine pitch canker, from two California sites by using a real-time PCR approach combined with a simple spore trapping method. *Applied and Environmental Microbiology* **70**, 3512–3520.
- Seem RC (1984) Disease incidence and severity relationships. *Annual Review of Phytopathology* **22**, 133–150.
- Selosse MA, Costa G, Battista CD, Tacon FI, Martin F (1996) Meiotic segregation and recombination of the intergenic spacer of the ribosomal DNA in the ectomycorrhizal basidiomycete *Laccaria bicolor*. *Current Genetics* **30**, 332–337.
- Shaw DE (1991) Rust of *Monstera deliciosa* in Australia. *Mycological Research* **95**, 665–678.
- Shaw MW (2002) Epidemic modelling and disease forecasting. In 'Plant Pathologist's Pocketbook'. (Eds JM Waller, JM Lenne and SJ Waller) pp. 252–265. (CAB International: New York)
- Sheta W (1996) Detection of *Cladosporium uredincola* in pustules of chrysanthemum white rust (*Puccinia horiana*). *Plant Disease* **80**, 599.
- Sivanesan A (1984) 'The Bitunicate Ascomycetes and their anamorphs.' (J. Cramer: Vaduz, Germany)
- Srivastave AK, Defago G, Kern H (1985) Hyperparasitism of *Puccinia horiana* and other microcyclic rusts. *Phytopathologische Zeitschrift* **114**, 73–78.

- Staples RC (2000) Research on the rust fungi during the twentieth century. *Annual Review of Phytopathology* **38**, 49–69.
- Staples RC (2001) Nutrients for a rust fungus: the role of haustoria. *Trends in Plant Science* **6**, 496–498.
- Staples RC, Hoch HC (1997) Physical and chemical cues for spore germination and appressorium formation by fungal pathogens. In 'The Mycota V'. (Eds Carroll and Tudzynski) pp. 27–40. (Springer-Verlag: Berlin)
- Sterling M, Rogers C, Levetin E (1999) An evaluation of two methods used for microscopic analysis of airborne fungal spore concentrations from the Burkard Spore Trap. *Aerobiologia* **15**, 9–18.
- Stewart CN (1997) Rapid DNA extraction from plants. In 'Fingerprinting methods based on arbitrarily primed PCR.' (Eds MR Micheli and R Bova) pp. 25–28. (Springer Verlag: Berlin)
- Struck C, Hahn M, Mendgen K (1998) Infection structures of plant pathogenic fungi - potential targets for plant disease control. *Journal of Plant Diseases and Protection* **105**, 581–589.
- Sugimoto M, Koike M, Hiyama N, Nagao H (2003) Genetic, morphological, and virulence characterization of the entomopathogenic fungus *Verticillium lecanii*. *Journal of Invertebrate Pathology* **82**, 176–187.
- Sugita T, Nakajima M, Ikeda R, Matsushima T, Shinoda T (2002) Sequence analysis of the ribosomal DNA intergenic spacer regions of *Trichosporon* species. *Journal of Clinical Microbiology* **40**, 1826–1830.
- Sullivan RF, White JF, Jr. (2000) *Phoma glomerata* as a mycoparasite of powdery mildew. *Applied & Environmental Microbiology* **66**, 425–427.
- Sutton BC (1980) 'The Coelomycetes. Fungi Imperfecti with Pycnidia, Acervuli and Stromata.' (Commonwealth Mycological Institute: Surrey, England)
- Sutton JC (1978) Relation of weather variables and host factors to incidence of airborne spores of *Botrytis squamosa*. *Canadian Journal of Botany* **56**, 2460–2469.
- Sutton S (2002) 'Export flower industry. A review of recorded statistics.' Rural Industries Research and Development Corporation, Publication No. 02/130, ACT, Australia.
- Swertz CA (1994) Morphology of germlings of urediniospores and its value for the identification and classification of grass rust fungi. *Studies in Mycology* **16**, 1–152.
- Sydow P, Sydow H (1904) Monographia Uredinearum. In 'Bibliotheca mycologica' pp. 891–892. (Cramer: Lehre)
- Takamatsu S (1998) PCR applications in fungal phylogeny. In 'Applications of PCR in Mycology'. (Eds PD Bridge, DK Arora, CA Reddy and RP Elander) pp. 125–152. (CAB International: Oxon)

- Talhinhas P, Sreenivasaprasad S, Neves-Martins J, Oliveira H (2002) Genetic and morphological characterization of *Colletotrichum acutatum* causing anthracnose of lupins. *Phytopathology* **92**, 986–996.
- Townend J (2002) 'Practical Statistics for Environmental and Biological Scientists.' (John Wiley & Sons Ltd: West Sussex, England)
- Traquair JA, Meloche RB, Jarvis WR (1984) Hyperparasitism of *Puccinia violae* by *Cladosporium uredinicola*. *Canadian Journal of Botany* **62**, 181–184.
- Tucker SL, Talbot NJ (2001) Surface attachment and pre-penetration stage development by plant pathogenic fungi. *Annual Review of Phytopathology* **39**, 385–417.
- Van Arsdell EP, Krebill RG (1995) Climatic distribution of blister rusts on pinyon and white pines in the USA. In 'Proceedings of the 4th IUFRO Rusts of Pines Working Party Conference.' Tsukuba, Japan. (Eds S Kaneko, K Katsuya, M Kakishima and Y Ono) pp. 127–133
- Vinnere O, Fatehi J, Wright SAI, Gerhardson B (2002) The causal agent of anthracnose of *Rhododendron* in Sweden and Latvia. *Mycological Research* **106**, 60–69.
- Waggoner PE, Aylor DE (2000) Epidemiology: a science of patterns. *Annual Review of Phytopathology* **38**, 71–94.
- Warner FE, McCartney HA, Emberlin J (2000) Wind tunnel comparison of the collection efficiency of three Hirst-type volumetric sampler drum coatings. *Aerobiologia* **16**, 25–28.
- Weber RWS, Webster J, Algharabally DH (1998) *Puccinia distincta*, cause of the current daisy rust epidemic in Britain, in comparison with other rusts recorded on daisies, *P. obscura* and *P. lagenophorae*. *Mycological Research* **102**, 1227–1232.
- Wharton PS, Dieguez-Uribeondo J (2004) The biology of *Colletotrichum acutatum*. *Anales del Real Jardín Botánico de Madrid* **61**, 3–22.
- White TJ, Bruns T, Lee S, Taylor J (1990) Amplification and direct sequencing of fungal ribosomal RNA genes for phylogenetics. In 'PCR Protocols: A Guide to Methods and Applications'. (Eds MA Innis, DH Gelfand, JJ Sninsky and TJ White) pp. 315–322. (Academic Press: San Diego)
- Williams RH, Ward E, McCartney HA (2001) Methods for integrated air sampling and DNA analysis for detection of airborne fungal spores. *Applied and Environmental Microbiology* **67**, 2453–2459.
- Wilson JP, Gates RN, Panwar MS (2001) Dynamic multiline population approach to resistance gene management. *Phytopathology* **91**, 255–260.
- Wood AR, Crous PW, Lennox CL (2004) Predicting the distribution of *Endophyllum osteospermi* (Uredinales, Pucciniaceae) in Australia based on its climatic requirements and distribution in South Africa. *Australasian Plant Pathology* **33**, 549–588.



Yehuda PB, Eilam T, Manisterski J, Shimoni A, Ankister Y (2004) Leaf rust on *Aegilops speltoides* caused by a new forma specialis of *Puccinia triticina*. *Phytopathology* **94**, 94–101.

Yli-Mattila T, Paavanen-Huhtala S, Bulat SA, Alekhina IA, Nirenberg HI (2002) Molecular, morphological and phylogenetic analysis of the *Fusarium avenaceum*/*F. arthrosporioides*/*F. tricinctum* species complex - a polyphasic approach. *Mycological Research* **106**, 655–669.

Yuan ZW, Pei MH, Hunter T, Royle DJ (1998) *Eudarlucis caricis*, the teleomorph of the mycoparasite *Sphaerellopsis filum*, on blackberry rust *Phragmidium violaceum*. *Mycological Research* **102**, 866–868.

Yuan ZW, Pei MH, Hunter T, Ruiz C, Royle DJ (1999) Pathogenicity to willow rust, *Melampsora epitea*, of the mycoparasite *Sphaerellopsis filum* from different sources. *Mycological Research* **103**, 509–512.