

## **The Breeding and Parentage of Hop Varieties**

**By Ing. Gerard W. Ch. Lemmens**

In the early eighties –having spent many hours reading through the dusty publications and reference books in Dr. Ray Neve s'archives, the then director of Hop Research at Wye College –I produced some parentage charts of hop varieties marketed at that time. This paper is an update to those previous works.

Prof. E.F. Salmon of Wye College in Kent, England, which was inaugurated as agricultural college in 1894, has been responsible for breeding the varieties Brewers Gold and Northern Brewer since 1907. These two varieties are not only well known all over the world, but have been used in breeding processes for breeding high bitter and dual purpose varieties around the globe (1).

Prof. Salomon s' publications in the *Journal of the South-eastern Agricultur-Brewing* are fascinating as he details even the names of the brewers and breweries who were involved in the brewing trials with these varieties. The following is an extract from one of these publications (2):

*In 1930 Messrs. W.T. Smith and A.T.C. Cosbie published the results of brewing trials carried out in the brewery of Messrs. Truman, Hanbury, Buxton & Co., London. OP 21, also called Brewers Favorite, was considered to posses a "distinct Oregon flavour ": and to show "promise of utility as a copper hop in suitable blends " but with too harsh a flavour for use as dry hops.*

When referring to the aroma of Brewers Gold, it is interesting to see references such as "Oregon " or "American "which have been changed nowadays to expressions such as "catty " and others. Many varieties (although not all) bred from Brewers Gold seem to have this "catty " aroma, which I assume was inherited from the Manitoban wild mother plant (ref. no. BBI).

Professor W.T. Macoun, Dominion horticulturist for Canada, wrote to Prof. Salmon in 1916: *The town of Morden is situated in southern Manitoba near a range of hills. The wild hops grow along a creek which flows through the town. Old residents in Morden assure me that there has never been any introduction of cultivated hops in this area. The wild variety, growing so abundantly along the creek, was transplanted to the town lots, especially along the fences, and back lanes, to cover unsightly places. "*

It would appear, therefore, that this plant, the female parent of C9a, is the species *Humulus americanus*.

Prof. Salmon, his successors and their American hop breeding colleagues seem to have kept careful records and regular publications of their findings. This, unfortunately, does not apply to all world hop breeders.

Those involved in the American hop breeding process such as A. Haunold, C.E. Zimmermann, S.T. Likens, C.E. Horner, D.D. Roberts, G.B. Nickerson, D.S. Kling and U. Gampert tend to publish in *Brewers Digest* or *Crop Science*.

There are many factors a hop breeder needs to take into consideration on behalf of the hop growers and brewers. This will be discussed first before summarizing the present grown varieties.

One needs to appreciate the time needed to breed a new variety as hops are a dioecious climbing plant. This means that there are female plants which are fertilized by the pollen of the male plants. When that takes place, the female flower (cone) will form seeds.

If one breeds new varieties, one therefore, needs to take great care that the female flowers are pollinated with the pollen of the male plant, which one wants to use in the breeding process. Otherwise, open pollination takes place,

*i.e.* the pollen of a wild male hop plant is blown by the wind onto the female flower; hence, the parentage of that male plant is unknown.

This happened quite frequently in the initial breeding processes, which is noticeable from The Parentage Chart of English Hop Varieties (Figure 1). In this and the other parentage charts, X means pollinating a female plant with the pollen of a male plant. If numbers are placed under the cross (X) sign, then that was the year the pollination took place.

In 1978, E. Small suggests the nomenclature for the genus and genera of the family of Cannabinaceae should be as sketched out in the The Botany of Hops (Figure 2) (3).

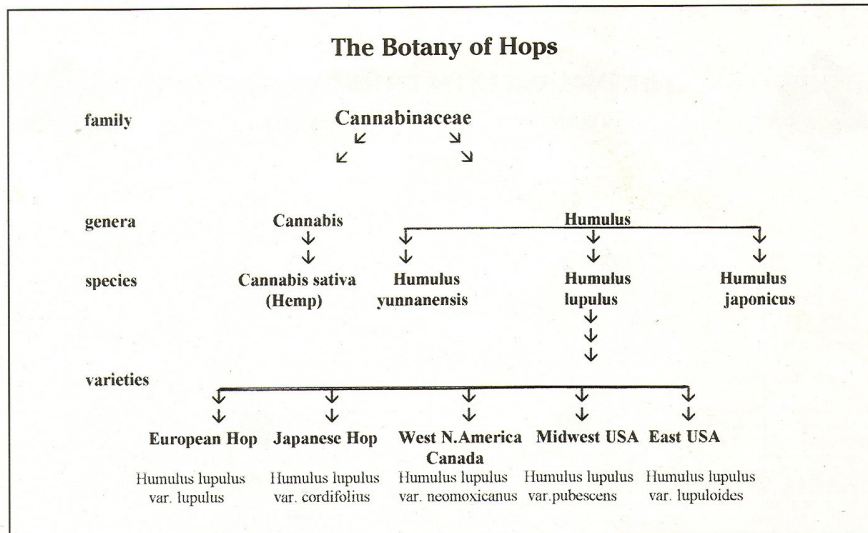

Figure 2



# THE PARENTAGE OF ENGLISH HOP VARIETIES

ISSUED BY

**MORRIS HANBURY JACKSON Le MAY LTD**

TELEPHONE: 08283 5155    NETTLESTAD OAST, PADDOCK WOOD, KENT    TELEX: 957062 HOPS G.

1983

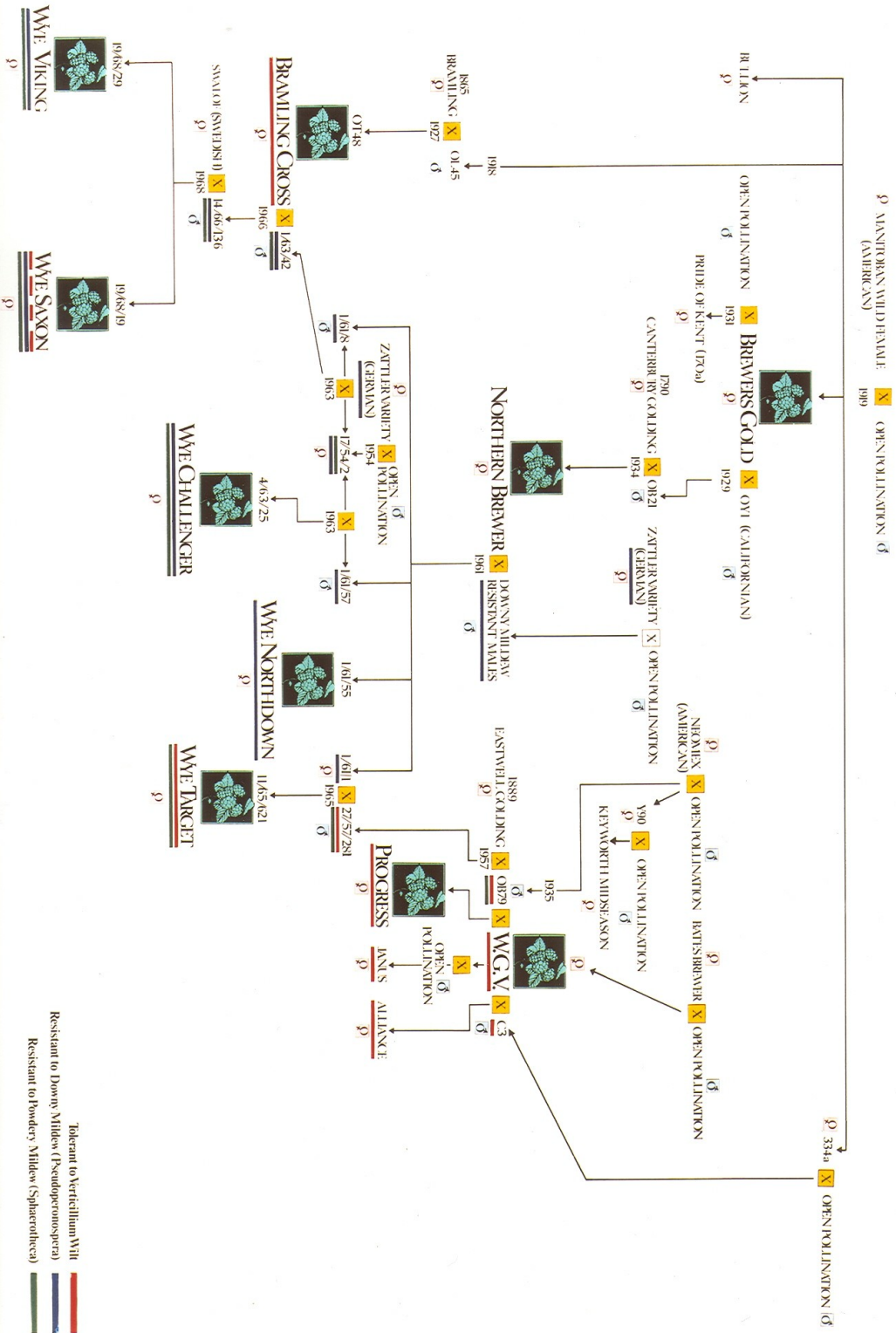

Tolerant to Verticillium Wilt  
 Resistant to Downy Mildew (Pseudoperonospora)  
 Resistant to Powdery Mildew (Sphaerotheca)

## **Factors Affecting the Breeding of New Varieties**

The following are some important factors, which the breeder needs to take into consideration on behalf of the grower and the brewer.

### ***Aroma***

One of the most important characteristics of hops is the different aroma of the different hop varieties. We tend to speak and refer to aroma, bitter and dual purpose varieties but, in essence, all hop varieties have a specific aroma which is liked or disliked, *i.e.* hop aroma is very personal.

This is one of the reasons why there are so many different hop varieties. The essential oil, ranging from 0.5 to 5% in hops, and the volatile degradation products of the resins together are responsible for the aroma in hops (4).

### ***Essential Oils***

The essential oil is a complex mixture of compounds, produced in the latter stages of ripening of the hop cone. They can be separated in two fractions:

- (a) The fraction eluted with light petroleum which consists of hydrocarbons and contains 50 to 80% of the whole oil with compounds such as Myrcene, Farnesene, Humulene and Caryophyllene. These compounds do not end up in the finished beer, but their oxidation products are more soluble and end up in the

beer, contributing to hop aroma. It is unfortunate that some breweries think that American hop varieties are too high in Myrcene content. This is, however, not an inherent characteristic of American hops, but merely a condition of good cold storage facilities where the hops are immediately kept after harvest; hence, keeping the Myrcene at high levels. As Myrcene is such a volatile compound, a high percentage immediately evaporizes when the hops are taken out of cold storage and also at the beginning of the boil in the brewing process. This is why a Brewer when dry hopping should take his hops or hop pellets out of cold store 24 hours before using them for dry hopping.

- (b) The fraction eluted with either, which consists of compounds containing chemically bound oxygen, such as alcohols (linalool and geraniol), esters, and carbonyl components. During the brewing process, some of these are transformed to other compounds which collectively could also contribute to aroma.

### ***Soft Resins***

This is the fraction of the total resins which is soluble in hexane. They contain the alpha acids, the beta acids and the uncharacterized soft resins, which will be briefly discussed.

### ***Alpha Acids***

The alpha acids consist of the following compounds: humulone, cohumulone, adhumulone, prehumulone and posthumulone. The humulones are important because the iso-humulones, which are formed during the boil, contain the principle form of bitterness of the beer. The cohumulones, discovered in 1952 by Rigby and Bethune, vary in quantities from 20 to 65%. High levels of cohumulone tend to be found in high bittered beers (ales, stouts and porters) and are the main factor contributing to harsh bitterness (5). The oxidation products of iso-alpha acids are less bitter.

### ***Beta Acids***

The Beta acids consist of the following unknown compounds: lupulone, colupulone, adlupulone, prelupulone, and postlupulone. No beta acids have been found in finished beer, but oxidation products of beta acids (hulupones) have been, which are bitter and some of these could contribute to harsh bitterness. The hulupones are about twice as bitter as iso-alpha acids in beer. Hence, hop addition should be based on the original harvest alpha acid content.

High levels of beta acids are to be found in the variety Galena. In the new (experimental) variety Santiam, the beta acids are actually higher than the alpha acids (6).

### ***Hop Storage Index***

The Hop Storage Index (HSI) is a method of measuring the percentage of alpha and beta acids which have been oxidized. It measures the optical density at 275 nm against that at 325 nm, which

is the UV maximum for alpha and beta acids. This ratio is the Hop Storage Index.

### ***Preservative Value or Antiseptic Power***

The soft resins were already considered by Prof. Salmon at the earliest stage of his hop breeding process. He refers to them in 1934 as the most important constituents of a hop for brewing purposes. He mentions the alpha acid and beta fraction which expressed in the formula  $a + b/3$  gives the best estimate of a hop antiseptic or preservative power.

### ***Hop Polyphenols (Tannins)***

Tannins, according to different hop varieties, vary from 2-5%. Present research on their role in the brewing process is carried out by Dr. Paul Hughes of the Brewing Research Foundation International. This will be complemented by Dr. Jan F. Stevens and Dr. Max L. Deinzer of Oregon State University, who at present are investigating the chemistry of polyphenols.

They will be extending their research this year into the influence of these compounds in the brewing process. It is thought that some of these oxidized compounds might affect the smoothness or harshness of bitterness and the body of the beer.

Hop polyphenols also play a role in the trub formation and in the forming or the precipitation of haze. They may have a modifying influence on the mouthfeel of the beer and may become of interest to the pharmaceutical industry (7).

Hop Variety	Alpha Acid Range	Beta Acid Range	Cohumulone as % of alpha	Total Oils %	Resistance to Wilt	Resistance to Downey Mildew	Resistance to Powdery Mildew
Ahtanum	3.5-5.5	5.0-5.5	32	1.0- 1.5	unknown	tolerant	moderate
Cascade	4.4-6.5	4.5-6.5	37	0.8-1.4	fairly tolerant	resistant	
Centennial	9.5-11.5	3.5-4.5	30	1.5-2.3	susceptible	susceptible	
Challenger	6.5-8.5	3.2-4.2	22	1.0-1.5	sensitive	some tolerance	susceptible
Chinook	12.0-14.0	3.0-4.0	32	1.5-2.5	tolerant	moderate	
Cluster	5.5-8.0	3.9-5.7	39	0.4-0.8	Sensitive	very susceptible	
First Gold	6.5-8.5	3.0-4.1	33	0.7-1.3	Resistant	Susceptible	Resistant
Fuggle	4.0-5.5	2.2-3.1	26	0.7-1.1	Sensitive	Some resistance	Susceptible
Galena	11.5-13.5	7.2-8.4	40	0.8-1.2	Sensitive	Some resistance	
Goldings	4.5-6.5	2.0-2.8	23	0.8-1.0	Sensitive	Susceptible	Susceptible
Hal. Tradition	4.8-6.5	3.7-5.0	28	0.7-1.3	Tolerant	Resistant	Some Resistance
Hersbrucker	3.0-5.0	3.8-6.2	23	0.6-1.1	Fairly Tolerant	Susceptible	Susceptible
Liberty	3.5-6.0	2.9-5.0	27	0.8-1.2	Sensitive	Resistant	
Magnum	12.0-14.0	4.2-4.9	25	1.5-2.1	Tolerant	Resistant	Moderate
Mt. Hood	4.0-6.5	3.6-5.9	23	1.9-1.3	Sensitive	Fairly resistant	
Northdown	7.0-10.0	4.4-6.2	29	1.2-2.2	Sensitive	Susceptible	Some resistance
Northern Brewer	7.0-9.0	3.2-4.1	29	1.2-1.8	Tolerant	Susceptible	Susceptible
Nugget	12.0-13.5	4.0-5.0	27	1.5-2.2	Sensitive	Fairly resistant	Resistant
Perle	5.5-8.5	3.1-4.7	29	0.7-1.2	Tolerant	Fairly resistant	Some resistance
Progress	5.0-7.5	1.8-2.7	27	0.5-0.8	Tolerant	Susceptible	Susceptible
Saaz	2.5-4.5	2.8-5.0	26	0.4-0.8	Sensitive	Susceptible	Susceptible
Spalter	3.5-5.5	3.5-5.5	26	0.7-0.9	Fairly Tolerant	Some resistance	Susceptible
Spalter Select	4.3-5.5	3.3-4.3	23	0.5-0.9	Tolerant	Fairly Resistant	Some Resistance
Styrian Golding	4.0-6.0	2.0-3.0	28	0.5-1.0	Sensitive	Susceptible	Susceptible
Super Styrian	8.0-10.0	3.8-4.8	25	0.9-1.4	Sensitive	Susceptible	Susceptible
Target	10.0-12.5	4.5-5.7	35	1.2-1.4	Tolerant	Susceptible	Resistant
Tettnanger	3.0-5.0	2.7-4.5	25	0.5-1.0	Tolerant	Some resistance	Susceptible
Willamette	4.5-7.0	3.0-4.7	32	0.9-1.5	Susceptible	Fairly resistant	
WGV	5.5-7.5	2.0-2.7	27	0.8-1.2	Tolerant	Susceptible	Susceptible

**Table 1**  
**Important Data and Characteristics of Hop Varieties**

### ***Resistance to Diseases***

With the spread of fungal and viral diseases, which has become very topical this year with the spread of Powdery Mildew to the Yakima Valley, it is naturally important to breed varieties which are resistant to the main hop diseases such as Downy Mildew (*Pseudoperonospora humuli*), Powdery Mildew (*Sphaerotheca humuli*), and Verticillium Wilt. Table I shows the resistance to these diseases for most presently grown varieties. Downy mildew was the reason for the decline of the hop culture in 1909 in New York State, followed in 1929 in Western Washington, in 1930 in Oregon, and in 1932 in California (8).

### ***Resistance to Pests***

Wye College have been and still are trying to breed varieties resistant to the main hop pest, which is DamsonHop Aphid (*phorodon humuli*). Some hop varieties tend to be more susceptible than others to this pest (9).

### ***Cone Structure***

The size and shape of the cone, the bracts and the strigs (the central axis of the cone) all contribute to the firmness of the cone. Firm cones result in a better filtration of the wort in traditional brewing with whole hops and using a hop back.

Although there are no records of the first appearance of hop aphids in Europe, it was stated by C.H. Parker in 1913 that they first appeared in 1863 in New York state and in 1890 reached the Pacific Coast. They have not reached New Zealand and affected their hop growing area.

One can control them by chemical sprays (which is an expense to the hop farmer and an environmental disadvantage), by biological control or by breeding varieties which are resistant. There are hop plants which tend to produce an odor that the hop aphid does not like, a characteristic useful in the breeding process.

Other common hop pests are the Spider Mite (*Tetranychus urticae*), the Dagger Nematode (*Xiphinema diversicandatu*), the Rosy Rustic Moth (*Hydroecia micacea*), the Flea Beetle (*psylliodes attenuata*), and the Earwigs (*Forticula auricularia*). This gives an indication of how difficult it must be to grow good quality "organic" hops without any sprays to combat these pests and diseases.

They are also easier to harvest during hop picking with less waste as the cones do not shatter so easily. They tend to form less seeds. For the shapes and sizes of the different hop varieties see Figure 3 and Figure 4, which will give some idea as to the appearance of cones of different hop varieties (10).

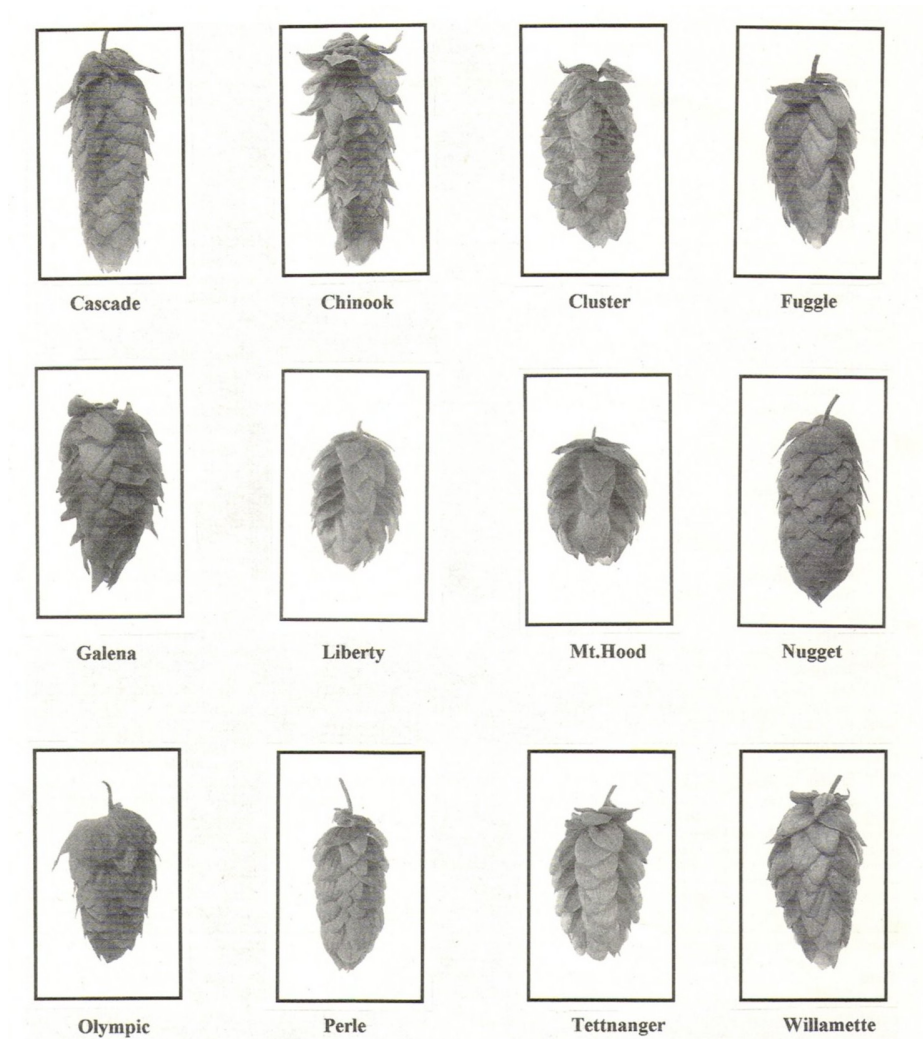

Figure 3. Hop Cones of American Grown Varieties

### ***Yield***

Depending on the soil type, the temperature, humidity, irrigation, manuring and chemical sprays used, each hop variety will give a different

### ***Color of the Cone***

The color of the cone should be pale green. Some chromosomes contain characteristics of red coloring of strigs,

rendament in weight of cones per acre. This will govern the income per acre, hence the price of hops. The best yield per acre of hops in the world is at present produced in China, whereas second best is Washington state (11).

which in some instances might affect the coloring of the cone, hence affect the stability of that variety. Galena is a variety which is on the border line for that possible problem (12).



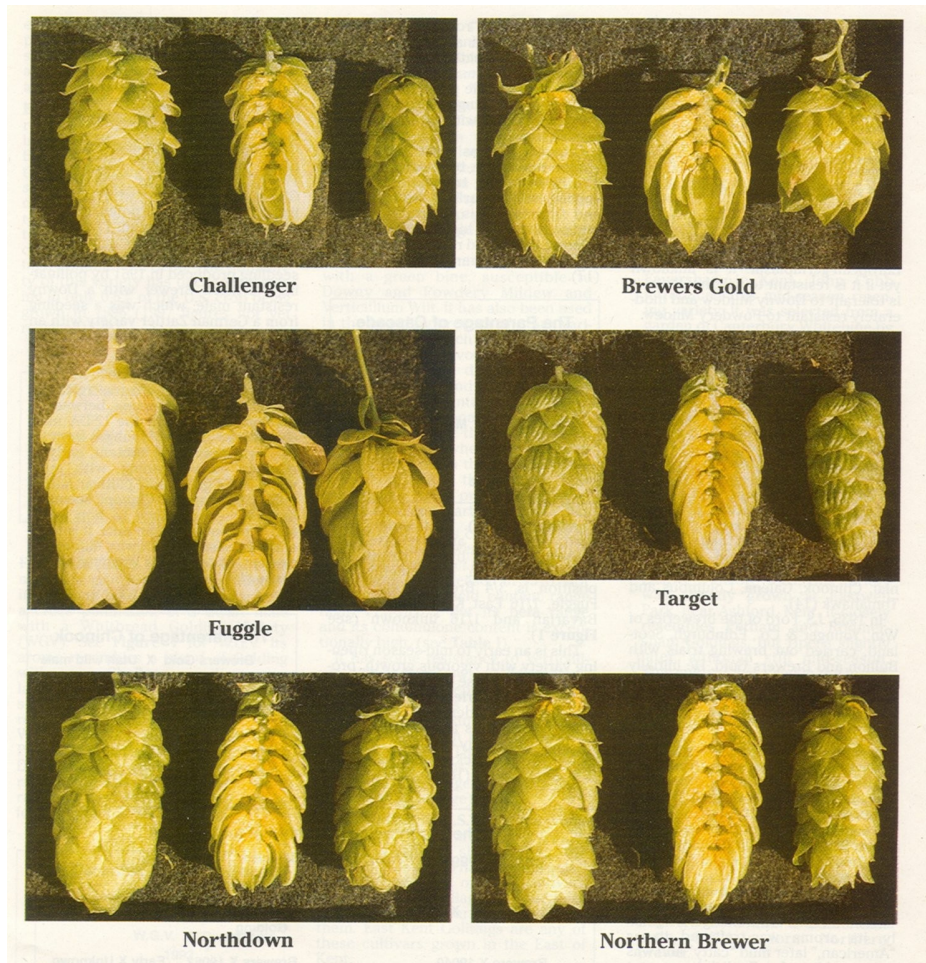

**Figure 4. Hop cones of some English varieties**

### ***Ripening Date***

It is important for the hop farmer to grow varieties which ripen at slightly different times, otherwise he has to harvest all his hops at the same time. Therefore, there are early, mid season and late ripening varieties.

### ***Twining of the Bine***

Some bines of some hop varieties twine better than others. An example of a difficult twining hop is the English variety Target. That variety, therefore, needs extra attention during the first

stages of its growth cycle; hence it adds extra cost to grow.

### ***Length of the Bine***

The longer the bine, the more expensive the wire work and overall growing cost. Hence, Wye College has bred some true dwarf hop varieties, for instance First Gold and Herald, which are now commercially grown in the UK. These dwarf varieties are now being considered by Oregon hop farmers as their climatic conditions and yields are similar to those in the United Kingdom.

### ***Country of Cultivation***

For the brewer, it is important in stability and currency (he might decide to buy in the currency of the hop producing country) to know in what country the hops are grown. The climatic conditions of that country affect other factors as well, such as yield, alpha acid levels, aroma and quality, not to mention price.

### ***Drying of Hops***

Some hop varieties, due to the texture, the length, width, and weight of the cones, dry more easily than others. The subject of drying of hops is, in my opinion, one of the most important aspects of hop production to which not enough attention has and still is not being paid.

I suggested some 15 years ago to experiment with brewing green (undried) hops. This experiment proved very successful and since then many Harvest Ales: have been produced, even in the U.S. in the last two years. This shows that drying is of major importance.

This is especially true for aroma varieties. It is significant that these are not dried too quickly or at too high of temperatures. They also should be packed lighter than high alpha varieties,

*i.e.* the present 200 lb bale packaging in the U.S. is, in my opinion, too tight for aroma varieties. The lupulin glands might rupture, resulting in the essential oils oxidizing and evaporating more rapidly.

I would advocate greater care during harvesting, drying and cooling prior to packaging, especially where it concerns aroma varieties, or varieties which the brewer wants to use mainly for aroma rather than alpha addition.

### ***New Hop Varieties***

In the past, the only source of newly bred varieties in the U.S. was the USDA-funded state breeding program. The Hop Research Council, founded in 1979, provides research funding to the various universities and colleges for hop research, which includes breeding of new varieties.

Private breeding programs of the hop dealers have in the last four years been responsible for producing seven to ten new varieties in the U.S. which all belong to the high alpha or now called super high alpha category. It seems to have become a super alpha race. These varieties are higher in alpha in alpha acid content (14.5-18.0%) and higher in yield of weight per acre. This will naturally affect the reduction in acreage under hop cultivation world-wide in the future (13).

## **Hop Varieties and their Parentage**

Most of the following varieties are at present marketed in the U.S. Some of these varieties, however, are not included in the annual USA Statistical Report produced by the Hop Growers of America, Inc.

The policy set by the United States Department of Agriculture (USDA) requires voluntary information of hop varieties grown if over 50 acres are planted or the variety is grown by more than one farmer. There are (hop dealer) farmers who do not want to divulge the information on all the varieties grown: hence, the classification of others (OT) is created.

### **Ahtanum (USA)**

This variety was recently bred by C.E. Zimmermann in the Yakima Valley, where at present it is grown in small quantities. It seems to have good characteristics with heavy yields. It has an interesting fruity aroma. The alpha range is 3.5-5.5%.

Its name is derived from the area near Yakima where the first hop farm was established in the 1870s. Unfortunately, its pedigree is kept rather mystified, apart from divulging it is of European-germplasm. It is unknown yet if it is resistant to wilt; however, it is tolerant to Downy Mildew and moderately resistant to Powdery Mildew.

### **Bullion (Q43) (USA)**

This cultivar was raised in 1919 by Prof. E.S. Salmon together with 334a and Brewers Gold from a wild Manitoban female hop (BB1) and English unknown malt plant (see figure

1). It is not grown in the U.K. anymore where it was only used by one large brewery and is only grown in small quantities in the U.S.

This variety has an alpha acid range of 7-9%, is late ripening with a green/red bine and susceptible to Downy and Powdery Mildew and Verticillium Wilt. Its aroma is quite catty, similar to that of Brewers Gold, Keyworth, Midseason, Brambling Cross, Centennial, Chinook, Galena, Columbus and Tomahawk (14).

In 1935, J.S. Ford of the breweries of Wm, Younger & Co., Edinburgh, Scotland, carried out brewing trials with Bullion and Brewers Gold. He initially found the aroma rank or American, but when blended with English varieties, their rank aroma did not pass into the beer.

### **Brewers Gold (Germany)**

Although this cultivar was bred by Prof. E.S. Salmon in 1919 and first grown in the U.K., its cultivation spread via Belgium to Germany, where its aroma seems to have become smoother over the years. It is late ripening, high yielding and green bined. The cones are spiky and medium to size.

In the past, it has been wrongly referred to in Germany as Hallertau Gold and Hallertau Goldings. Originally, its aroma was referred to as American, later mild catty and was only used by a few English brewers at up to 20% of the hop grist. It has been a significant cultivar, widely used in the breeding of many hop cultivars world-wide (see **Figure 1**) (15).

It was at the time a plant with the highest alpha acid content and exceeded in preservative value. It was also planted in the late 1930s in Canada and in the U.S., Washington and New York states (16).

### Cascade (USA)

This variety was bred in 1956 but was not released for cultivation until January 1972. It reached its peak of about 13.3% of the total American crop in 1975, declining to about 2% now. It is said that its popularity with microbreweries stems from Prof. Michael Lewis using it in recipes some 15 years ago.

It has a unique r se flower  roma. Its pedigree originates from a seed which was collected from a plant obtained by crossing an English Fuggle with a male plant which originated from crossing the Russian variety Serebrianka with a Fuggle male (see **Figure 1**).

Originally, it was immediately tested for resistance to Downy Mildew. The first brewing trials in 1968 were carried out by Carling, Stroh, Schlitz and Olympia. This variety ripens in mid-season, is a high cropper, fairly tolerant to wilt and resistant to Downy Mildew. Its alpha ranges from 4.5-6.5% (17).

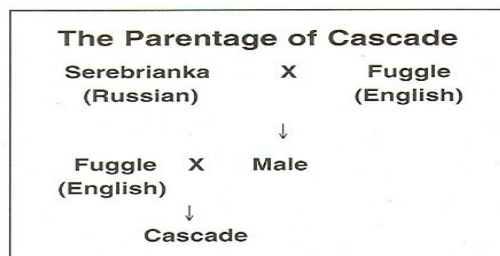

### Centennial (USA)

This variety was bred in 1974 and released in September 1990 by S.T. Kenny and C.E. Zimmermann. The genetic composition is 3/4 Brewers Gold,

3/32 Fuggle, 1/6 East Kent Golding, 1/32 Bavarian and 1/16 unknown (see **Figure 1**).

This is an early to mid-season ripening variety with vigorous growth, producing small, dense, small cones. It is not yet known if this variety is resistant to wilt, but it is moderately resistant to Downy Mildew. Its alpha ranges from 9.5-11.5%. Probably due to its Brewers Gold breeding background, its aroma is slightly c atty (18).

### Challenger (U.K. and Belgium)

This variety with its distinct wonderful lemon type aroma was bred in 1963 by Dr. Ray A. Neve, who started a tradition with the prefix Wye (*i.e.* officially this variety is named Wye Challenger). It is a late ripening and medium cropping variety. The bine has a distinctive dark violet color, it is sensitive to wilt, some resistance to Downy Mildew, but susceptible to Powdery Mildew. The alpha acid content ranges from 6.5-8.5%, the beta acids from 3.2-4.2%. Its cohumulone content is low: 22%.

Its parentage is as follows: A female plant number (and not named) 17/54/2 was bred in 1954 from a German Zattler variety which was pollinated with an open pollination (*i.e.* unknown male). The plant 17/54/2 was pollinated in 1963 with a numbered (1/61/57) male plant, which was a seedling produced in 1961 by pollinating Northern Brewer with a Downy resistant male, which was a seedling from a German Zattler variety with an open pollination. See Figure 1 for its parentage.

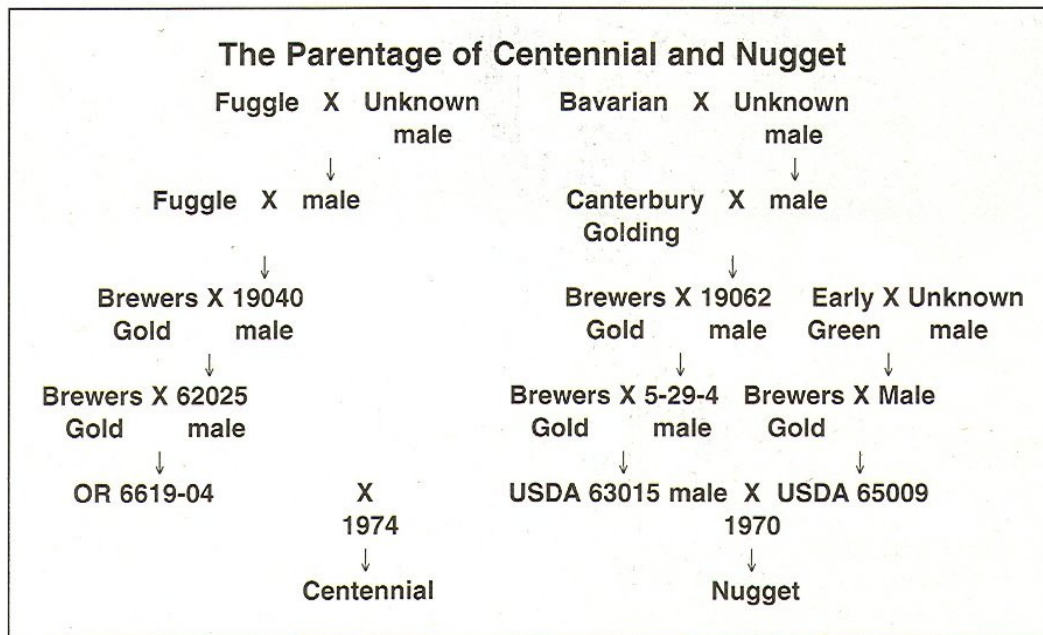

### Chinook (USA)

In May 1985, this new hop cultivar (W-421-38) was released, originating from a cross between a Petham Golding and the USDA male 63012M. Its alpha acid ranges 12-14%, with high oil content, early to medium early ripening, with good vigor. It is a green bine cultivar, with a mild catty aroma. Chinook seems to have some resistance to hop aphid and two-spotted spider mite. It is moderately resistant to Downy Mildew. At present, it is grown in Washington and Idaho (19).

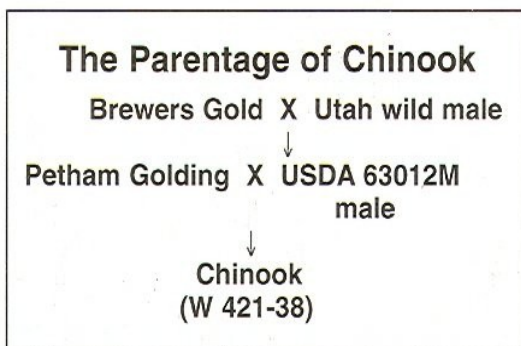

### Cluster (USA)

There appear to be no records of the origin of this cultivar. However, from their characteristics, it is suggested that they arose from hybridization of varieties imported by Dutch and English settlers and indigenous male hops. There appear to be early and late ripening Clusters. It is a plant with a green bine and it is very susceptible to Downy Mildew. The alpha acid ranges from 5.5-8.0%, with a mild catty aroma.

### Eroica (USA)

This cultivar was released in 1979 in Idaho. It was bred in 1968 with its sister, Galena, from Brewers Gold with an open pollination. Eroica has a pale green bine, with some red pigmentation. The cones are compact, tightly pointed and resistant to Downy Mildew. The alpha acid content ranges from 10-13% and is a good cropper, with a catty aroma and a high cohumulone of 36. The popularity of this variety has declined, resulting in only 0.5% of the U.S. crop being grown in 1996 (20).



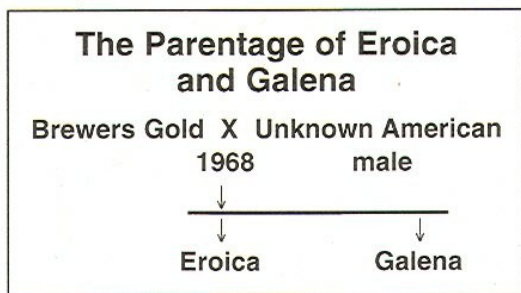

### First Gold (U.K.)

This is the first commercially grown dwarf hop, released in 1995 and bred by Wye College from a cross pollination of a dwarf male with a Whitbread Golding Variety (WGV). See Figure 1 for W.G.V. Its aroma resembles a blend of Golding with some Challenger and crops a large number of medium cones. It seems to have inherited from W.G.V. a reasonable tolerance to Verticillium Powdery Mildew, but is susceptible to Downy Mildew and is a mid-season ripening cultivar. The alpha acid ranges from 6.5-8.5%. It is being used for bitter and aroma purposes.

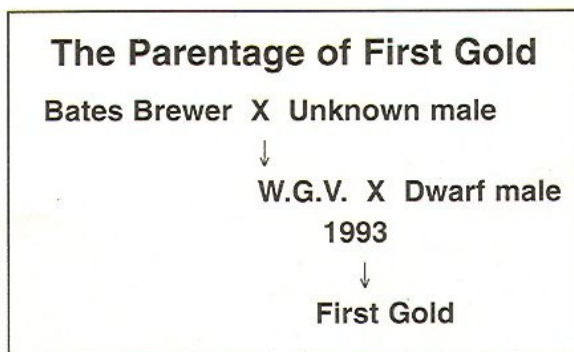

### Fuggle (U.K., U.S., Slovenian Republic)

In 1861, this variety was noticed growing in the garden of George Stace's house at Horsmonden in Kent, England. It was not until 1875 that it was

introduced by Richard Fuggle, who lived at that time in the village of Brenchley, which is only a few miles away from Horsmonden.

Fuggle was so extensively grown throughout the U.K. that by 1949 it reached 78% of the total English crop. In the 20<sup>th</sup> Century, it was grown in the U.S., Tasmania, Canada, Belgium, Austria and Yugoslavia (now Slovenian Republic). I mention Yugoslavia because it is not called Fuggle there but Styrian Golding. The reason for this mishap in names is as follows: In the 1930s, the Yugoslavian hop industry went down with a Verticillium Wilt strain that affected their aroma hops which were of German origin. They then looked to the U.K. for new plant material and thought that they had chosen an English Golding, hence called it Styrian (originally Steirer, after a hop growing area on the Austrian/Yugoslavia border) Golding.

It is an early mid-season variety with a green bine, susceptible to Downy and Powdery Mildew and Verticillium Wilt. It has also been used in the breeding process of other varieties bred there such as Buket, Dunar, Neoplanta and Vojvodina. This is set out further when discussing Super Styrian varieties and their parentage chart. The disadvantage of the use of Fuggle in traditional brewing whole hops is that the cone shatters easily, especially when they are over ripe, slowing down the filtration time in the hop back in the brewery. This has become more problematic when machine picking was started in the 1950s.

### **Galena (US)**

This cultivar was bred in 1968 from Brewers Gold and an open pollination, *i.e.* an unknown male plant and released in 1978. Not only is its alpha acid content range high, 11.5-13.5%, but its beta range and its cohumulone content is exceptionally high. (see **Table 1**).

It has some resistance to Verticillium Wilt and to Downy Mildew. However, it is very susceptible to Powdery Mildew, which has been significant this year in the Yakima Valley. It is an early to mid-season ripening cultivar with a green bine. The bracteoles are pointed at the tips, lanceolate and long (see Parentage of Eroica and Galena for its lineage) (21).

### **Goldings (U.K. & U.S.)**

This is a group of cultivars which are slightly different, as will be shown. Over the decades, this group has been changed and widened. Most of these cultivars are named after villages in east Kent or after the hop farmers who grew them. East Kent Goldings are any of these cultivars grown in the East of Kent.

Mid Kent Goldings are, on occasion, referred to as East Kent Goldings, which is incorrect. East Kent Goldings are a premium hop; hence, the price is higher than Kent or Worcester Goldings. The soil and climatic conditions and maybe the husbandry of the farmers in that part of Kent make it a unique and delicate aroma, superb for use in craft ales and lagers.

In the United Kingdom, Goldings are grown in East Kent, Mid Kent, Hampshire, Worcestershire and Herefordshire. In the U.S., they are grown in Oregon and the Yakima Valley, where the cultivar is mainly

Canterbury Golding, which will be mentioned due course.

Goldings have an alpha acid range of 4.5-6.5%, are early to mid-season ripening with mainly a green colored bine. They are susceptible to Downy and Powdery Mildew and Verticillium Wilt. The following cultivars are known:

**Amos s' Early Bird** This early ripening variety has a green bine witherred mottling. It is referred to as an offspring of Bramling. In 1887, this cultivar was selected from a garden of Bramlings by Alfred Amos, a hop farmer in Wye. His great-grandson, Charles Amos, unfortunately gave up hop farming in the early eighties.

**Cobbs** In 1881, in Sheldwich near Faversham in Kent, John Cobb introduced this mid-season ripening variety. It was selected from a garden of Canterbury Whitebine by a hop farmer, James West. This cultivar is still grown in the U.K.

**Brambling** In 1865, this cultivar was grown extensively. However, the date of origin is not known, although it was selected by a farm bailiff named Smith on Musgrave Hilton s'farm at Bramling near Canterbury. It is an early ripening cultivar. In 1927, a female plant of this variety was crossed with a male plant, OT45, a brother of Brewers Gold, to result in the variety Bramling Cross, also called OT48 (see **Figure 1**).

**Eastwell** Before 1889, this variety was already grown at Eastwell Park, near Ashford, Kent. It closely resembles Petham and Rodmersham Goldings, but ripens slightly later, although still mid-

season. This cultivar was used in the breeding process of Target.

**Canterbury** Shortly before 1790, this famous variety, also called Old Golding or East Kent Golding, was selected by Mr. Golding of the village of Malling in Kent from a garden of Canterbury Whitebine. Its bine is speckled with red. It seems more susceptible to hop aphids than other Golding cultivars and is late ripening. This variety is used in the U.S. for growing Goldings. A female plant of this cultivar was crossed in 1934 with a male plant, OB21, which was a seedling from Brewers Gold and a Californian male, OY1, to form Northern Brewer.

**Petham** Although there are no records of its origin, it is assumed this mid-season ripening variety was first grown in the village of Petham near Canterbury. It has a less red mottled bine and it resembles Eastwell and Rodmersham Goldings.

**Rodmersham** About 1880, this cultivar was selected by Robert Mercer of Rodmersham House near Sittingbourne, Kent, from a hop garden near Malling which was said to be more than 100 years old. This mid-season ripening variety is sometimes referred to as Mercer's Golding. It is similar to Eastwell and Petham.

**Mathon** This late ripening variety was originally grown in the village of Mathon, Worcestershire. In 1906, John Percival stated that the Mathon is closely related in botanical characters to the Canterbury Whitebine. Drawings of this variety were used in porcelain factories in Worcestershire in 1790s. Morris Hanbury has the only remaining plate,

dated 1794, hanging in its boardroom in Kent.

### **Liberty (U.S.)**

This aroma variety was the 1983 result of a cross made between the colchicines induced tetraploid female cultivar Hallertau Mittelfruh (USDA 21397) and a Downy Mildew resistant male (USDA 64035M). It is therefore, a half sister to Mt. Hood. In 1985, the number USDA 21457 was assigned to this variety. This early ripening aroma cultivar is very similar in technical data (oil contents) and in its aroma to Hallertau Mittelfruh. It is fairly resistant to Downy Mildew and not much is yet known about its sensitivity or resistance to Wilt. Its alpha acid content ranges from 3.5-6.0% and the beta acids range from 2.9-5.0%.

This cultivar and Mt. Hood are really the first German noble aroma type varieties grown in the U.S. It seems that Liberty's aroma is carried through well into the final beer when uni-tanks are used for fermentation of ale beers. See the chart containing the parentage of Liberty and Mt. Hood for its pedigree (22).

### **Magnum (U.S., Germany)**

This variety was bred in the 1980s at Huell, the German Hop Research Institute. It is a late season ripening cultivar, tolerant to wilt, resistant to Downy Mildew and moderately resistant to Powdery Mildew. It is due to Morris Hanbury's encouragement in 1994 that this variety is grown in the U.S.

The alpha acid content ranges from 12.0-15.0% with the beta acids ranging from 4.2-5.0%. However, the two most significant advantages of this variety is that its cohumulone is (especially for a



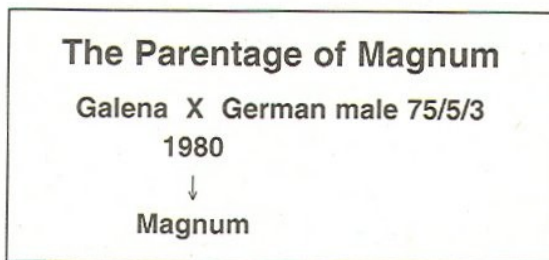

high alpha variety) as low as that of Fuggles and Goldings, *i.e.* 25% and that its oil content is fairly high, 1.5 to 2.1 ml per 100 gram (dry).

As I have mentioned previously in this paper, the cohumulone content is one of the factors contributing to harsh bitterness. It has been experienced by many small and large breweries in the U.S. that Magnum contributes a significantly smooth bitterness in beers with more than 30 BU s.' Compare to other high or super alpha varieties, it also has an extremely nice aroma, *i.e.* similar to that of a strong Willamette or Northdown.

The variety, in combination with Willamette, Fuggle and East Kent Golding, seem to work well, to such an extent that several gold and silver medals have been obtained at beer competitions in Denver and Chicago using Magnum as the bittering hop. One would never have thought, therefore, that the parentage of Magnum is a Galena mother crossed with a German male plant 75.5.3. This shows that knowing the parentage of a hop plant is interesting, but really does not give much decisiveness on its aroma (23, 24).

#### **Mt. Hood (USA)**

This cultivar was the result of a cross made in 1983 between a colchicines induced tetraploid female Hallertau Mittelfruh (USDA 21397) and a male hop (USDA 19058 M). In 1985, the

number USDA 21455 was assigned for Mt. Hood. It is a high yielding, early to mid-season ripening hop with oil contents very similar (hence, also a similar aroma) to that of Hallertau Hersbrucker.

It is fairly resistant to Downy Mildew, hence suitable for growing in Oregon and Idaho, but it is also cultivated in Washington State. It is sensitive to Wilt. The alpha acid ranges from 4.0-6.5%, with beta acid ranging from 3.6-5.9%. It is, in my opinion, very suitable for use in ales as well as lagers. See the parentage of Liberty and Mt. Hood for its pedigree (25, 26).

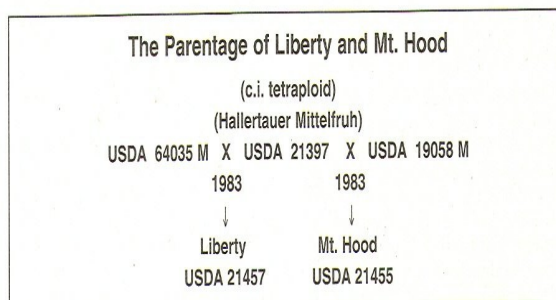

#### **Northdown (U.K., Belgium)**

This is a variety with an alpha acid level of 8-10% and a good aroma resembling that of a strong Fuggle or Willamette. There seems to be plentiful aroma as the total oils range from 1.2 to 2.2 ml per 100 gram (dry). The cohumulone content is 29%.

This variety was bred by Dr. Ray A. Neve at Wye College in 1961 from a Northern Brewer female plant and a downy resistant male. Northdown inherited some resistance to Downy Mildew. It is susceptible to Powdery Mildew and it is sensitive to Verticillium Wilt.

This variety has been happily used together with Challenger by many British brewers in ales as well as lager brewing. It is a mid to late ripening variety with a dark violet bine. See **Figure 1** for the lineage of the Northdown.

### **Northern Brewer (USA, Germany, Belgium)**

This was one of the first bitter varieties Prof. Salmon bred which had a good acceptable aroma, reference WFB 135. It was raised by him in 1934 from a female Canterbury Golding pollinated with a male seedling, reference OB21. The cultivar OB21 was obtained by crossing Brewers Gold with the Californian male plant, referred to as OY1. This cultivar (OY1) was obtained in 1914 from E.C. Horst, who was engaged with the British Columbia Hop Co. Ltd. He stated that its origin was

The Russian River, Mendocino County, section of California, USA. "It was named North Brewer because a brewing company in the north of Britain (Scottish and Newcastle) had been very interested in the breeding of a high alpha (7-9%) and good aroma variety.

The bine of this variety is a distinctive violet color that seems to be inherited by several varieties which have been bred from Northern Brewer. It also stands out in the field because of its rather dark green leaves and its column type growth. This early ripening variety is susceptible to Downy and Powdery Mildew and Verticillium Wilt. Prof. Salmon records the following (27):

*On samples (1939 growths) of WFB135 and WFA12 (a close plant of the former), Mr. A.C. Reavenall, of Messrs. Charrington, London (I was*

*Research and Development Brewer at this Brewery where I had a 30 Brl "experimental" Brewhouse), reported: "WFA12 smacks decidedly of America, and so does WFB135," and added "would be very suitable for growing in East Kent." On samples of these two hops, 1940 growth, Mr. J.S. Ford and his colleagues reported (this Journ., 1942, 146): "WFB135; fine rich normal fragrance. WFA12; very rich fragrant hop, very slightly citronellal flavour." On a half-pocket of WFB135 grown in 1942 in Wye Field Garden, Mr. J.S. Ford reported: "Very fine hop, fragrant aroma; fine side."*

Northern Brewer has been extensively used in the breeding process of Hueller (bitterer), Perle, Record, Aurora, Bobek, Buket, Dunar, Neoplanta, Vojvodina, Northdown, Challenger, Target, Viking and Saxon. At one stage, it was extensively grown in England, Belgium and Germany, but has been replaced with higher and super alpha varieties to the extent that it is not grown in England anymore. Personally, I find its aroma very similar to that of Nugget. See **Figure 1** for its parentage.

### **Nugget (USA, Germany)**

In 1970, a cross was made at Corvallis, OR, between the female germplasm line USDA65009 and the male USDA63015M. The lineage of Nugget is 5/8 Brewers Gold, 1/8 Early Green, 1/16 Canterbury Golding, 1/32 Bavarian (but which Bavarian?) and 5/32 unknown. However, if one looks back at the lineage of Centennial, it is noticeable that the father of Centennial is the same as the father plant of Nugget, i.e. USDA63015M. The mother plant,

USDA65009 was obtained by crossing Brewers Gold with a male Early Green seedling.

Once again it is interesting that more than half of its lineage (5/8) is Brewers Gold and Nugget does not seem to have inherited the typical catty but, instead, the Northern Brewer type aroma. This cultivar is sensitive to Verticillium Wilt, fairly resistant to Downy Mildew, and most important at present for growing in the Yakima Valley, it is resistant to Powdery Mildew.

Its alpha acid content ranges from 12.0-13.5%, while its beta acids range from 4.0-5.0%. Although its cohumulone is low, *i.e.* 27%, it still appears in the ale beers with high bitter levels to give a slight harsh bitterness compared to Magnum. The total oils in Nugget are high, 1.5 to 2.2 ml per 100 gram (dry).

This is a very suitable variety to use more as a base bitterness for lager beers and low bitter ales beers, rather than in high bitter leveled ale beers for which Magnum would be recommended. See the Parentage of Centennial and Nugget (28, 29).

### **Progress (U.K)**

This variety was bred at Wye College in 1951. In my opinion, it is one of the successful English bred aroma varieties which not only has a good noble aroma (probably between a Fuggle and an East Kent Golding), but also a decent alpha acids content, ranging from 5-7.5%, with beta acids ranging from 1.8-2.7% and 27% cohumulone. The total oils are on the low acid, 0.5-0.8%.

Particularly for traditional brewing, *i.e.* with the use of whole hops and a hop back, this variety is extremely suitable as the cones are quite firm and hence; create a good, natural filter bed. This cultivar was bred for resistance to Verticillium Wilt. It is, however, an early ripening variety, which is susceptible to Downy and Powdery Mildew. See **Figure 1** for its lineage.

### **Styrian Golding (Austria, Slovenian Republic)**

In the former country of Yugoslavia, hops were grown in two districts, one near Lake Bled in the Savinja Valley and the other in Backa near Zagreb. Styrian (Steirer) Golding are grown on the border of Austria and the Savinja Valley.

By genetics they are true English Fuggles, which are grown seedless. Hence, they are slightly higher in alpha acid content, ranging from 4.0-6.0%. The beta acids are very similar to Fuggles, 2.0-3.0% and the cohumulone is 28%.

The Savinja Valley suffered badly in the early 1930s from a disease which devastated their (German origin) aroma cultivars. This resulted in a visit to England to obtain an English aroma variety. They thought they had selected a Golding, so they called it Styrian or Steirer Golding unaware it was a Fuggle they had selected. This variety is being used extensively in the U.K. as a dry-hopping variety.

### **Super Styrians (Slovenian Republic)**

This is a group of high alpha varieties, bred in the Slovenian Republic in the late sixties (see the chart entitled The Parentage of Slovenian and Backa Hop Varieties for lineage). Of the A' "

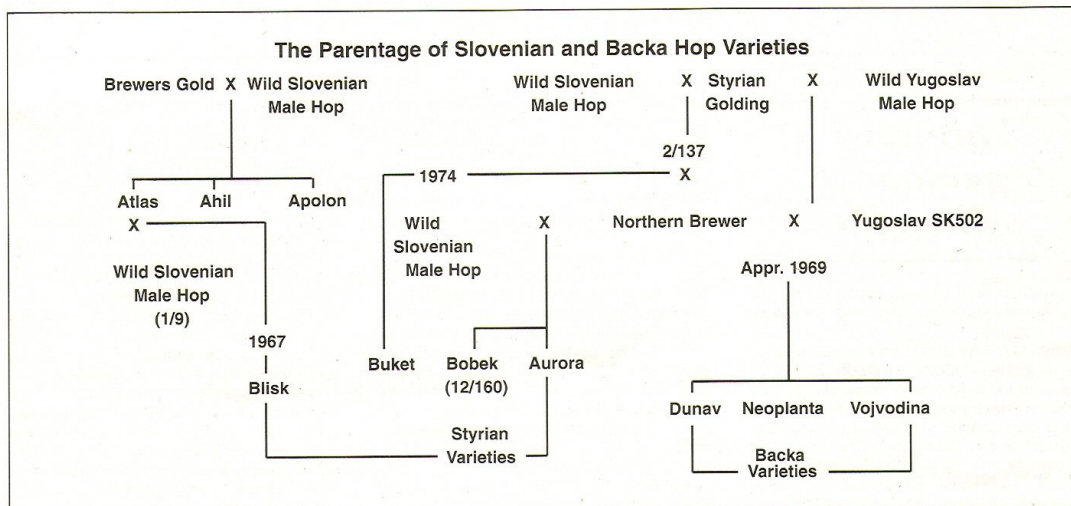

varieties (Aurora, Atlas, Apolon and Ahill), the predominant variety grown at present is Aurora, which has the violet bine and its cūpressus ŝhape together with its aroma in common with its mother plant, Northern Brewer.

The alpha acid content of Aurora ranges from 8-10% with the beta acids ranging from 3.8- 4.8% and its cohumulone being low at 25%. The oil content is at a reasonable level of 0.9 to 1.4 ml per 100 gram (dry). This variety is fairly unknown outside Europe, but deserves, in my opinion, more attention. It is an early to mid season ripening cultivar, sensitive to Verticillium Wilt and susceptible to Downy and Powdery Mildew.

#### **Target (U.K., Germany)**

Another successful variety bred by Dr. Ray A. Neve in 1965 is Target, which is closely related to Northdown, Challenger, Progress, Eastwell Golding and Northern Brewer. For its lineage, see **Figure 1**. This late ripening cultivar has , it has been used to replace Goldings. It is a mid to late ripening cultivar with a slightly purple to green colored bine, susceptible to Downy and Powdery

an extremely dark violet bine, it is resistant to Powdery Mildew, but susceptible to Downy Mildew and tolerant to Verticillium Wilt.

Having see this variety grown from the its beginnings in 1973 has confirmed my belief that any newly bred variety really needs five years for its aroma to mature. The alpha acid is from 10-13%, the beta acids from 4.5-5.7%. The cohumulone is 35%, and the total oils range from 1.2 to 1.4 ml per 100 grams (dry).

#### **W.G.V. (UK) White s'or Whitbread s' Golding Variety**

This is the 47<sup>th</sup> seedling raised in 1911 by Mr. White, who owned a hop farm at Beltring in Kent . Dr. Keyworth spotted that this variety (referred to as 1147) was Wilt tolerant. It was then grown as a new variety. Since Whitbread Brewery had purchased Mr. White s' farm, it was renamed Whitbread Golding Variety (W.G.V.)

Because of its noble aroma Mildew. Its alpha acids range from 5.5-7.5%, its beta acids from 2.0-2.7% and its cohumulone is 27% with an oil

content of 0.8-1.2%. See **Figure 1** for its lineage.

### **Willamette (USA)**

This cultivar is a triploid sister of Columbia. For triploid hop breeding, I refer to Al Haunold's detailed explanation on this subject in *Brewers Digest*, Vol. 63, No. 10, 1988, pp. 40-41. Because of its fine and noble aroma, suitable for ale and lager brewing, I feel that this cultivar is probably one of the most successful American bred aroma varieties. Its alpha acid acids range from 4.5-7.0%, beta acids range from 3.0-4.7% with a 32% cohumulone. This cultivar is susceptible to Verticillium Wilt, but fairly resistant to Downy Mildew (30, 31).

To conclude, I would like to mention that this paper is not complete and excludes many other U.S. bred varieties such as Columbia, Columbus, Comet, Crystal, Bianca, Horizon, Olympia, Santiam, Sunbeam, Talisman, Ultra and others.

What about the future? I think we will see more disease and pest resistant dwarf varieties being bred and grown even here in the United States, not only because of economic reasons but also for environmental demands. We shall see what happens in ten years time. The U.K. bred, first commercially grown dwarf variety, First Gold will still be around, I think, even here in Yakima Valley.

### **Acknowledgments**

I would like to thank Alfred Haunold and Chuck Zimmermann for their genealogical assistance to some U.S. hop varieties and my secretary, Cynde Skiffington, for her patience while typing this.

### **References**

- (1) G.W. Ch. Lemmens, *The Brewer*, January, 1983, pp. 10-14
- (2) E.S. Salmon, Two New Hops: 'Brewers Favourite' and 'Brewers Gold', *J.S.E. Agricultural College*, Wye, 1934, pp. 93-106.
- (3) R.A. Neve, *Hops*, Leonard Hill, London, 1991.
- (4) M. Versele, D. De Keukeleire, *Chemistry and Analysis of Hop and Beer Bitter Acids*, Elsevier, Amsterdam, 1991.
- (5) George J. Fix and Laurie A. Fix, *An Analysis of Brewing Techniques*, Boulder, 1997, p. 35.
- (6) Ann George, Washington Hop Commission, Santiam-USDA 21 664, leaflet, 1997.
- (7) V.E. Peacock, Fundamentals of Hop Chemistry, paper presented at the annual MBAA Convention, Baltimore, October, 1997.
- (8) M.A. Tomlan, *Tinged with Gold*, The University of Georgia Press, Athens/London, 1992.
- (9) A.H. Burgess, *Hops*, Leonard Hill, London, 1964.
- (10) K.S. McGree, Hop Growers of America, Inc., Variety sheets.

- (11) K.S. McGree, Hop Growers of America, Inc., Annual Statistical Report, 1995-1996.
- (12) C.E. Zimmermann, personal communication, Yakima, August, 1997.
- (13) The Barth Report, Nuremberg, 1996/97, p. 20.
- (14) E.S. Salmon, *J.S.E. Agricultural College*, Wye, No. 42, 1938, pp. 47-59.
- (15) Morris Hanbury Jackson LeMay Ltd, The Parentage of English Hop Varieties, 1983.
- (16) Don Van Valkenburg, A Question of Pedigree The Role of Genealogy in Hop Substitutions, *Brewing Techniques*, Sept./Oct., 1995, pp. 54-59.
- (17) C.E. Horner, S.T. Likens, C.E. Zimmermann and Alfred Haunold, Cascade-A New Continental-Type Hop Variety for the U.S., *Brewers Digest*, Vol. 47, No. 8, 1972, pp. 56-62.
- (18) S.T. Kenny and C.E. Zimmermann, Registration of Centennial Hop, *Crop Science*, Vol. 31, July/Aug., 1991, pp. 1092-1093.
- (19) S.T. Kenny and C.E. Zimmermann, Registration of Chinook Hop, *Crop Science*, Vol. 26, Jan./Feb., 1986, pp. 196-197.
- (20) R.R. Romanko, Joy Jaeger, Gail B. Nickerson, C.E. Zimmermann and Alfred Haunold, Registration of Eroica Hop, *Crop Science*, Vol. 22, Nov./Dec., 1982, p. 1261.
- (21) R.R. Romanko, Joy Jaeger, Gail B. Nickerson, C.E. Zimmermann and Alfred Haunold, Registration of Galena Hop, *Crop Science*, Vol. 19, July/Aug., 1979, p. 563.
- (22) A. Haunold, G.B. Nickerson, U. Gampert and P.A. Whitney, Registration of Liberty Hop, *Crop Science*, Vol. 32, No. 4, 1992, p. 1071.
- (23) A. Haunold, personal communications, February, 1998.
- (24) P.B. Signorotti, personal communications, February, 1998.
- (25) A. Haunold, G.B. Nickerson, Registration of Mt. Hood Hop, *Crop Science*, Vol. 30, No. 2, 1990, p. 423.
- (26) Gerard W. Ch. Lemmens, Hops in America A 20 Year Overview, *Brewing Techniques*, Nov./Dec., 1996, pp. 56-65.
- (27) E.S. Salmon, Four Seedlings of the Canterbury Golding, *Journal of Inst. Of Brewing*, Vol. 50, Sept./Oct., 1994, pp. 244-250.
- (28) A. Haunold, S.T. Likens, G.B. Nickerson and R.O. Hampton, Registration of Nugget Hop, *Crop Science*, Vol. 24, May/June, 1984, p. 618.
- (29) A. Haunold, S.T. Likens, G.B. Nickerson and S.T. Kenny, Nugget, A New Hop Cultivar with High Alpha-Acids Potential, *Journal of the American Society of Brewing Chemists*, Vol. 42, No. 2, 1984, pp. 62-64.
- (30) A. Haunold, C.E. Horner, S.T. Likens, D.D. Roberts and C.E. Zimmermann, Registration of Willamette Hop, *Crop Science*, Vol. 16, Sept./Oct., 1976, p. 739.
- (31) A. Haunold, S.T. Likens, C.E. Horner, G.B. Nickerson and C.E. Zimmermann, Columbia and Willamette, Two New Aroma-Type Hop Varieties, *Brewers Digest*, Vol. 52, No. 11, 1977, pp. 36-39, 56.