

**FREE
COMPETITION!
WIN A NEW GCL MICRO**

SUMMER 1983 85p.
**Personal
Computer**

G A M E S

**FULL PROGRAM LISTINGS
FOR SIX POPULAR MICROS**

**REVIEWS ON 22
EXCITING GAMES**

**GET MORE OUT OF
YOUR MICRO WITH OUR
GUIDE TO ADD-ONS**

**ACTION FREEZE!
FULL-COLOUR STILLS
FROM SIX POPULAR GAMES**

**THE MAGAZINE THAT GIVES YOU THE TOP GAMES
FOR YOUR MICRO-INCLUDING DRAGON, SPECTRUM,
ZX81, ATARI, ORIC, BBC, COMMODORE, APPLE.**

2130

Can you beat that?

TAKE UP THE
CHALLENGE OF POSTERN'S

*Imaginations
Unlimited*

...and see if you can beat Luke's super scores!

SHADOWFAX

Fight the black riders whose touch is death. You must guide **Shadowfax** as Gandalf's swift white horse braves the dread riders of Sauron, Dark Lord of Mordor. How many will your thunderbolts destroy? Magnificent graphics.

Luke says — "It's 7-riffic. The better you do, the bigger the challenge." 2130 to beat! Do you have the lightning-fast eye to beat Luke at his favourite game?*



SNAKE PIT

Imagine yourself in a snake pit. The snakes and their eggs must be gobbled up before the snakes eat the Gobbler ... who must eat the last egg before the first snake. Eat the eggs, and more snakes are freed to attack. Eat all the snakes and the game begins again ... but faster! Faster!

Luke's comment: "Better than Pacman. It's a reeely fun game! 12570 eggs to gobble if you want to beat my best. Get it?"*

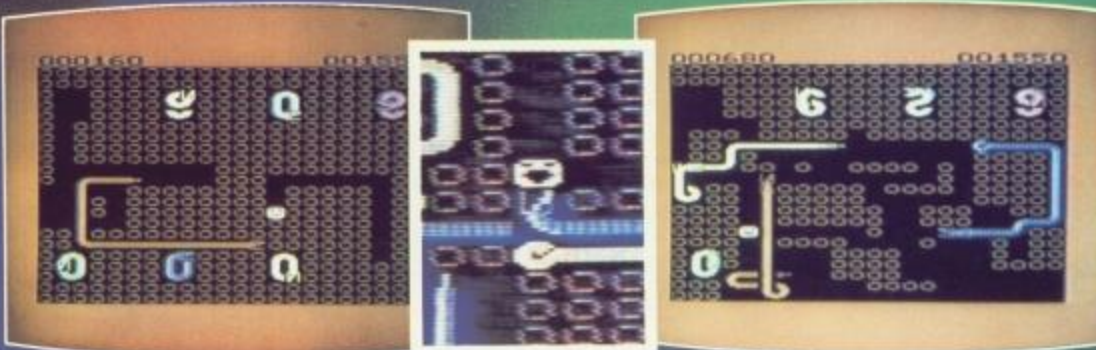

SIEGE

Watchfulness and skill protect your castle from the encircling marauders in this **Siege**. Drop rocks to dislodge them, and their anger makes them faster ... and faster! Are you fast enough to hold them back from the top of the wall? Speed your reflexes.

Luke says — "Bet you can't keep the Glooms away as long as I did?" 4360 to beat! That's difficult.*

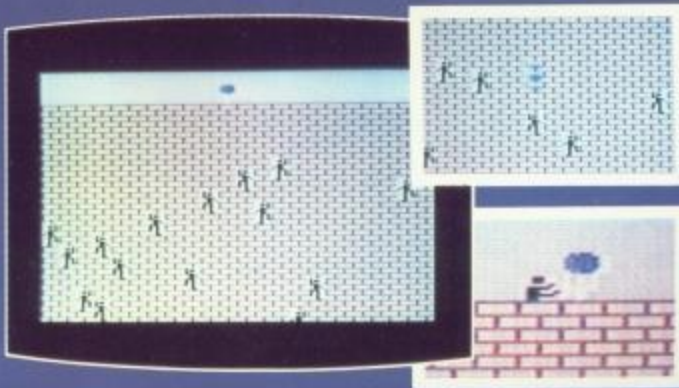

Is Luke only a boy, or has constant exposure to Postern Imaginations Unlimited given him new powers in the world of the imaginations? Find the answer yourself with these new Imaginations Unlimited games.



COMPUTER TYPE: (Tick box)
 Commodore 64
 BBC 'B'
 Spectrum
 No disc for Spectrum



Got a good game or game idea? *Luke says* "If it's really good, send it to me soon. I'm testing lots more games for Postern. We're big enough to pick the best from a big range of games — so watch these pages for the very best in games! Write to me with your super scores, too!"

Look for the **IMAGINATIONS UNLIMITED** symbol — only on games from Postern — to offer you a really super challenge!

Available from many computer stores.

To order by post please send your cheque, postal order or Access/Visa card number with this coupon. →

To: **Postern Limited**
 P.O. Box 2, Andoversford
 Cheltenham, Glos. GL54 5SW
 or telephone: (0242) 82741
 (24 hour order service)

Please send me: (Write quantity in boxes)
 SHADOWFAX at £7.99 On Tape or £9.99 On Disk
 SNAKEPIT at £7.99 or £9.99
 SIEGE at £7.99 or £9.99 (Beaker)
 Total £ _____ or Access/Visa no. _____
 Name: _____ Address: _____

*The scores quoted were achieved on a Spectrum computer — Different computers give different score potential.

Personal
Computer

GAMES

Dear Reader,

Welcome to the first issue of *Personal Computer Games* – Britain's newest magazine for microcomputer games enthusiasts.

There has been such a surge of interest in computer games recently that the problem facing most people is not so much finding enough games, as deciding how to choose among the thousands of packages available.

That's where *Personal Computer Games* can really help you.

If you want to know what a game actually looks like on the screen before you buy it, take a look at our exclusive Action Freeze! section. It will show you in full colour precisely what you will see when you run the program.

The display is only the beginning of the story. Look a little further on in the magazine, and you will find page after page of games reviews.

They tell you honestly just what you will – and will not – get for your money.

And for the most up-to-date news on what is available and where to get it, turn to the listings in Screen Scroll.

Of course, we have not forgotten the all-important hardware. We have scoured the shops for the zappiest peripherals around.

We even take a 'no holds barred' look at two of the most recent home computers: the Oric-1 and the Lynx.

As if that was not enough, we are offering you the chance to win a free home computer package.

We'll be featuring the winning entry in our next issue. And who knows, you might end up like 17-year old Richard Jones, whom we interview in this issue.

Whatever your age and interest, or the size of your pocket, you're sure to find *Personal Computer Games* packed with fascinating and really useful information.

Good reading!



Editor

WHAT'S

GOA

NEWS

The latest information on games just released – and those still being planned ... Dragonalia comes to your screen ... and Sing-a-Long-a-Micro. pages 2,3

COMPETITION



Let your imagination run riot and win a computer that has been specially designed for games enthusiasts. page 17

THE LIFE GAME



How Richard Jones challenged the competitive market of computer games, and launched three successful companies by the time he was 17. page 8

BOOSTERS



It is often difficult to find the right peripherals to boost your micro's powers and your fun. Our special review tracks down the suppliers for you. page 18

ADVENTURE

The Program Control Guardians protect the world from rogue games. They introduce themselves to you in the first of a regular series. page 15



THOUGHTS

Puzzles for high, medium and not-so-low IQs. From Mensa, the high IQ society. page 27

INSIDE

M

E

S

HARDWARE

The newest British micros include a strong rival to the Spectrum and a very upgradable home computer. Would you buy one? page 32



BOOKS

If you are trapped in the micro maze, you need a good guide. We review some books that can give you an open sesame. page 47

HUMOUR



Commodore ... karate ... poltergeists ... and health. Kipper Williams sketches the trials of games addicts and goes over the top. page 48

ACTION FREEZE!

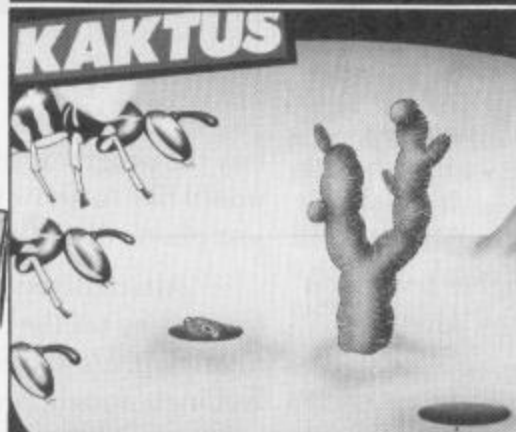

Six popular games have been timed and frozen in mid-action. We take off the trimmings to show you what they are really like. page 50

D-I-Y

A selection of program listings that will bring you hours of fun, pleasure and frustration. page 67

SCREEN SCROLL

Try before you buy. We did. And we tell you what we think. page 93

Editor: Deirdre Boyd
Consulting editor: Geof Wheelwright
Art director: Jim Dansie
Advertising: Peter Goldstein, Herbert Wright
Ad production: Laura Cade
Publisher: Fiona Collier
Publishing director: George Littlejohn

Cover and Action Freeze! illustrations by Mark Watkinson

Personal Computer Games gratefully acknowledges the support of its sister magazines, *Personal Computer World* and *Personal Computer News*, and their journalists, who have contributed to this magazine.

Announcing more exciting programs for the BBC.

Acornsoft is the software division of Acorn Computers, the company that designed and built the BBC Microcomputer. Here are four more exciting programs, all designed to get the most from your BBC Micro.

Magic Garden (£9.95) is a cassette based on Shirley Conran's successful book. It's a problem-solving program which provides the complete beginner with instant answers to the questions of what to plant and where. Simply tell the computer whether you prefer a shrub or a flower, the type of soil, light and shade conditions and required flowering time and the computer will come up with a selection of possible plants.

Draughts & Reversi (£9.95) is a cassette containing two traditional board games for you to play against the computer. Both give a graphic display of the board on the screen and you can enter your moves with either keyboard or joystick. The games can be played at varying levels of difficulty and on the higher levels you will find the computer to be a very worthy adversary.

Hopper (£9.95) is a game on cassette which can be played with either keyboard or joysticks. Hop the frog across the busy motorway trying to avoid four lanes of fast-moving traffic. To get across the river to the frog's lair you must leap on to the logs and turtles' backs, but beware of the diving turtles, the crocodile and the snake.

BCPL (£99.65) is a flexible modern structured language that's very easy to learn. The package consists of a BCPL language ROM, a 40/80 disc and a 450 page User Guide. The disc contains the BCPL Computer, a Screen Editor and a 6502 Assembler. BCPL is particularly good at handling Input and Output and is ideal for writing utility programs and to develop games and commercial packages.

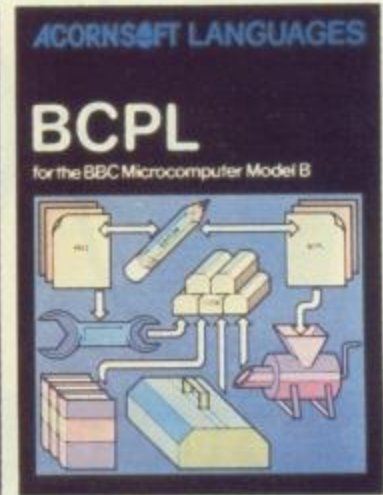
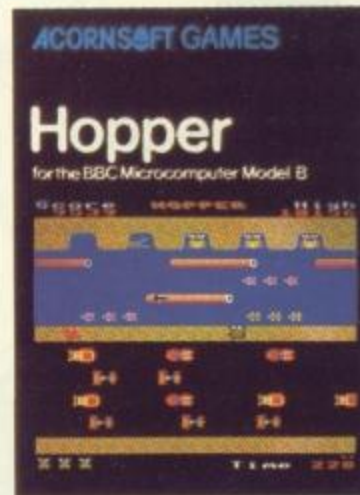

How to get Acornsoft programs.

If you're a credit card holder and would like to buy the programs shown in this advertisement, or if you would like to know the address of your nearest stockist, just phone 01-200 0200.

Alternatively, you can buy the programs directly by sending off the order form below to:
Acornsoft, c/o Vector Marketing, Denington Estate, Wellingborough, Northants NN8 2RL.

Also use this form if you would like to receive the current free Acornsoft catalogue.

Please allow 28 days for delivery.

☎ Credit Card Holders. Telephone 01-200 0200.

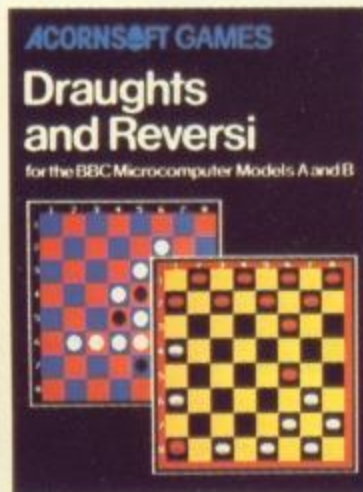
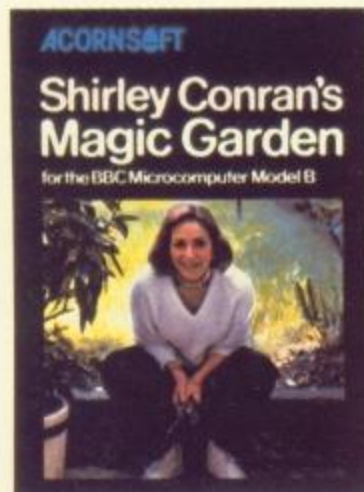

To: Acornsoft, c/o Vector Marketing, Denington Estate, Wellingborough, Northants NN8 2RL.

Please send me the following:-

PROGRAM	PRICE	QUANTITY	TOTAL	(Code Acornsoft use only)
Magic Garden	£9.95			SBX04
Draughts & Reversi	£9.95			SBC20
Hopper	£9.95			SBG23
BCPL	£99.65			SNL03

TOTAL

I enclose PO/cheque payable to Acornsoft Ltd.

Or charge my credit card.

Card Number _____

(Amex/Diners/Visa/Access (Delete))

Please send me the Acornsoft brochure

Name _____

Address _____

Postcode _____

Signature _____

PCG:B

Registered No. 1524763. VAT No. 215 8123 85

ACORNSOFT

Place	Weeks on Chart	Game · Publisher
1	13	Zaxxon · Datasoft
2	2	Miner 2049er · Big Five
3	38	Frogger · Sierra On-Line
4	38	Deadline · Infocom
5	37	Zork II · Infocom
6	28	Zork III · Infocom
7	38	Temple of Apshai · Epyx
8	38	Zork I · Infocom
9	39	Choplifter · Broderbund
10	9	Suspended · Infocom
11	34	Snooper Troops #1 · Spinnaker
12	40	Wizardry · Sir-Tech
13	34	Apple Panic · Broderbund
14	34	Snooper Troops #2 · Spinnaker
15	25	Castle Wolfenstein · Muse
16	22	Miner 2049er · Micro Lab
17	24	Ulysses & the Golden Fleece · Sierra On-Line
18	11	AE · Broderbund
19	2	Dig Dug · Atari
20	29	Starcross · Infocom
21	25	Flight Simulator · Sublogic
22	6	B-1 Nuclear Bomber · Avalon Hill
23	25	Flight Simulator · Microsoft
24	31	Pinball · Sublogic
25	4	Shamus: Case II · Synapse
26	10	Jump Man · Epyx
27	37	Sargon II · Hayden
28	1	Donkey Kong · Atari
29	15	Fort Apocalypse · Synapse
30	38	Preppie · Adventure International
31	13	Sea Dragon · Adventure International
32	11	Necromancer · Synapse
33	1	Repton · Sirius
34	38	Shamus · Synapse
35	31	Crossfire · Sierra On-Line
36	30	Aztec · Datamost
37	1	Frogger · Comsoft
38	28	Serpentine · Broderbund
39	8	Pharaoh's Curse · Synapse
40	6	Spy's Demise · Penguin
41	14	Gorf · Roklan
42	39	Knight of Diamonds · Sir-Tech
43	2	Final Orbit · Sirius
44	1	VC · Avalon Hill
45	20	Way Out · Sirius
46	20	Wizard of Wor · Roklan
47	30	Mask of the Sun · Ultrasoft
48	28	Centipede · Atari
49	36	Canyon Climber · Datasoft
50	37	Ali Baba & the Forty Thieves · Quality

Chart courtesy of Softsel International.

THE WORLD'S TOP GAMES

The chart above shows Softsel's hot list of games as at the middle of June. It is compiled from sales to over 4,000 retail outlets in 50 states and 30 countries.

Softsel is the world's largest wholesale distributor of personal computer software. It supplies more than 3,000 product lines to over 4,000 outlets worldwide. European operations are centred at Feltham, near Heathrow airport.

Software for Apple, Atari, IBM, Commodore, Tandy,

Texas Instruments, and CP/M micros is available from Softsel through such suppliers as Thorn EMI, Micro Soft, Sierra On-line, Broderbund, Micropro, IUS, Automated Simulation, Infocom, Sirius and Spinnaker.

In June, major multiple computer retailer Spectrum signed Softsel as its sole source for US software. The announcement gave Softsel over 350 outlets only two months after its UK launch in April.

JUST ARRIVED

English Software is proving to be one of the most prolific independent producers of software for the Atari.

In June, it announced no less than 11 new cassette games for the Atari 400/800. The programs included Airstrike, Venus Voyager 2, Timewarp, Escape from Perilous, Xenon Raid, Firefleet, Diamonds, Crazy Kopter, and Caverunner.

All sell for £14.95 including VAT.

August will see four more games: Hyperblast, Captain Sticky's Treasure, Airstrike 2, and Jet Boot Jack. These are on cartridge and sell at the dearer price of £29.95.

English Software says it plans to release at least one new game program every month. 'We're always on the

look out for new programmers,' it avers.

English Software can be contacted at 50 Newton Street, Piccadilly, Manchester M1 2EA. Tel: (061) 236 7259.

Softek launched six new games at the beginning of June. Four are for the Spectrum, one is for the Oric, and one is for the Dragon.

Amongst the new Spectrum games is Joust, written by 15-year-old Andrew Gleister.

Firebirds is a shoot-up vertical game, while Megapede provides a very high-quality version of the Centipede arcade game.

The Spectrum games cost £5.95; the others cost slightly more.

PSST — IS THIS THE ULTIMATE?

Recently established Ultimate Play the Game sees itself as 'the most experienced arcade video game design team in Britain'.

Its members were some of the first people to produce arcade games for the US and Japan.

'We were unhappy working for someone else,' said director Timothy Stamper, 'so we decided to set up our own company.'

The turnover is high, and is all reinvested in the company.

Ultimate's aim is to produce a range of entirely original arcade-quality home computer software. Its first offering, Jet Pac, was released in May.

Suitable for 16K or 48K Spectrums, Jet Pac is comprised of 16 waves of aliens, with four spaceships to assemble, each of which is divided into three sections.

True to its arcade origins, the program includes a player/game selection page which allows you to choose one- or two-player games, and a keyboard or Kempston joystick select. This selection appears after each game is played.

Ultimate's latest offering, PSST, was released in June.

The packaging shows Robbie the Robot sitting on a flower and defending it from what look like tiny Weetabix with wings and eyes.

Robbie's job is to defend the flower from interstellar space slugs, scuttling leeches and menacing midges. It is also designed to work with the 16K or 48K RAM Spectrum.

Ultimate is releasing two more games for the 16K Spectrum at the end of July. Tranzam is a high-speed pursuit race across the US.

The map is real and the playing area 600 times bigger than the actual viewing size of the screen.

Cookie is a game where Charlie the Chef and his ingredients fight off the Bin Monster and other nasties. Stamper describes it as 'incredible'.

All these retail at £5.50, including VAT. They will be available at all larger branches of WH Smith, John Menzies, Boots, and other major software retailers.

The games can also be obtained through mail order from Ultimate Play the Game, The Green, Ashby-de-la-Zouch, Leics LE6 5JU. Tel: 0530-411485.

SPECTRUM 48K : ZX81 16K SIX PART ADVENTURE



BLACK CRYSTAL THE QUEST IS ABOUT TO BEGIN

The ultimate role-playing adventure for the SPECTRUM/ZX81. You can become a warrior, elf or wizard on a quest to find and use the rings of creation: to destroy the Black Crystal and defeat the Lords of Chaos. Held within six programs lies a land of fabulous treasures and mythical monsters. Journey through the land of Beroth, explore the castle of shadows, descend into the Shaggoths lair, search for diamonds in the sea of sand but beware of sand sharks! Confront the fire demon in his temple, battle against the Lords of Chaos and win your way to the Black Crystal.

By splitting Black Crystal into six programs we can provide more variety and detail than any other adventure for the Sinclair computers.

Real time monster battles. Superb graphics. Save game feature. All six parts are supplied together on cassette, boxed with instruction booklet.

**SPECTRUM 48K: 180K OF PROGRAM
IN SIX PARTS — ONLY £7.50**
**ZX81 16K: OVER 100K OF PROGRAM
IN SEVEN PARTS — ONLY £7.50**
**WHY PAY MORE FOR LESS OF AN
ADVENTURE**



To: CARNELL SOFTWARE, DEPT 2, 4 STAUNTON RD, SLOUGH, SL2 1NT.
Please send me: Black Crystal for my,

- Spectrum 48K..... £7.50
 ZX81 16K..... £7.50

I enclose a cheque/postal order (payable to Carnell Software) for £

NAME

ADDRESS

TRADE ENQUIRIES WELCOME

CRASH

MICRO GAMES ACTION

SPECTRUM GAMES BY MAIL!
USE THIS COUPON TODAY -
NO STAMP NEEDED!



By the time you've travelled to your nearest stockist the games you buy can cost twice as much. Ordering direct from **CRASH MICROGAMES ACTION** means never having to leave your video action thrills, and immediately plugs you into our comprehensive range of high quality programs, and **makes you savings** because there are no delivery or postage charges. You will also receive our regular, illustrated catalog to keep you informed about all the latest games.

SPECIAL INTRODUCTORY OFFER!

(only with this coupon)

£1 off purchase price for 2 cassettes

£2 off purchase price for 3 cassettes

(subtract from the subtotal on the order form)

No stamps needed! Just use the FREEPOST address below. (PCG)

Name

Address

Please send me your catalog listing 50 other exciting games for the SPECTRUM. I enclose 50p (stamps or P.O.) which I understand will be refunded with my first purchase (catalogs are sent automatically to customers ordering with the coupon below).

Please tick the titles	you wish to purchase	Price
<input type="checkbox"/> THE HOBBIT	Melbourne House 48K	£14.95
<input type="checkbox"/> PENETRATOR	Melbourne House 48K	£6.95
<input type="checkbox"/> TERROR-DAKTIL 4D	Melbourne House 48K NEW	£6.95
<input type="checkbox"/> TIMEGATE	Quicksilva 48K	£6.95
<input type="checkbox"/> TRADER	Quicksilva 48K NEW	£9.95
<input type="checkbox"/> ARCADIA	Imagine 16/48K	£5.50
<input type="checkbox"/> AH DIDDUMS	Imagine 16/48K	£5.50
<input type="checkbox"/> 3D TANX	DKtronics 16/48K	£4.95
<input type="checkbox"/> GOLD MINE	DKtronics 16/48K NEW	£4.95
<input type="checkbox"/> ORBITER	Silversoft 16/48K	£5.95
<input type="checkbox"/> GROUND ATTACK	Silversoft 16/48K	£5.95

*Please make checks & postal orders payable to CRASH MICRO.

SUBTOTAL £
LESS SPECIAL DISCOUNT £
***TOTAL ENCLOSED** £

All prices shown include VAT & postage. Allow 28 days, although orders will be despatched by return whenever possible.

CRASH MICRO, FREEPOST, (No stamps)
SHROPSHIRE SY8 1BR

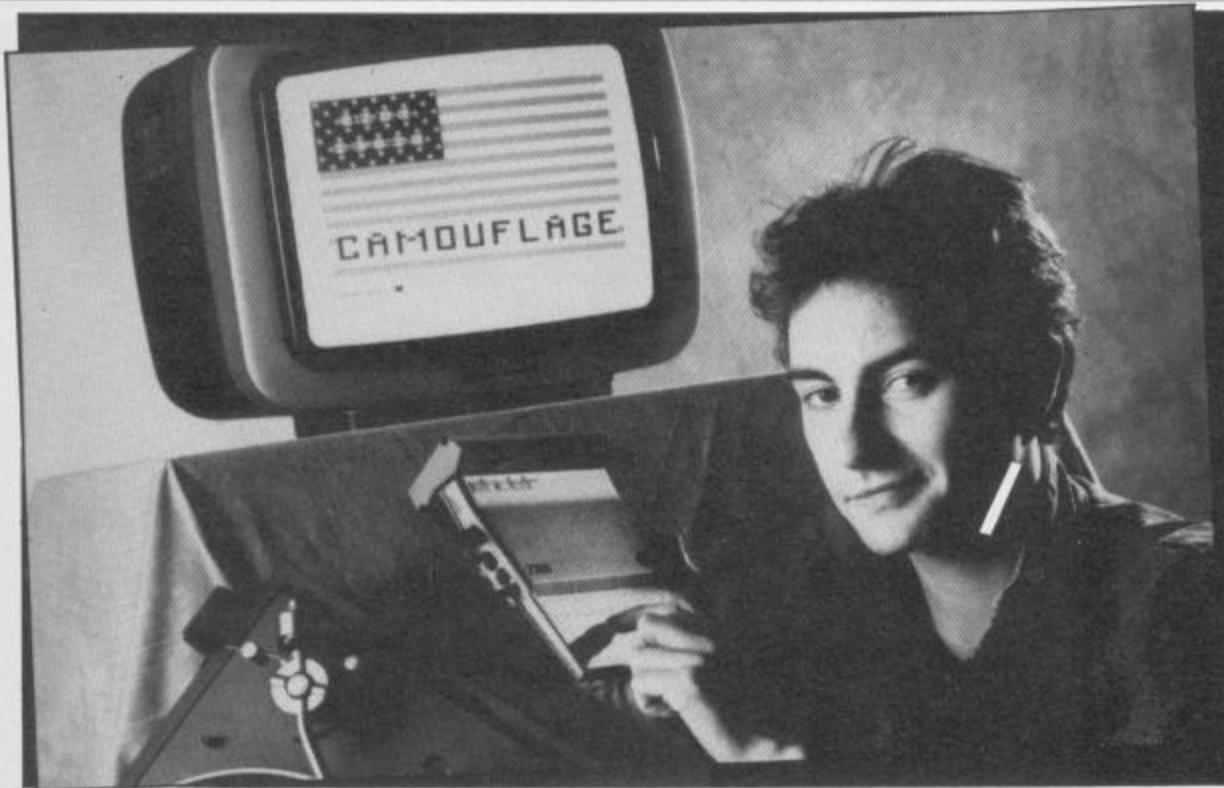

COMING — THE SCREEN PLAY OF THE BOOK

The feudal planet of Pern, its fire-breathing dragons, dragon riders, and lord holders have been immortalised in the 10 million books sold to hungry Anne McCaffrey fans.

Now the Nebula award-winner has given games manufacturer Epyx the licence to market a computer game based on her characters.

McCaffrey was in the lucky position of being able to pick and choose who should market the game.

Epyx was chosen because of 'its good track record and good distribution,' she said.

'I was approached by three or four companies, and my research indicated that it was the better one.'

More importantly, McCaffrey wanted a company that would remain true to the spirit of her books.

Her younger son, Todd, is in the US helping to design the game.

'He also helped to design the Mayfair board game,' said McCaffrey.

'He has an Atari and my older son has an Apple.'

'The dragon riders and lord holders are in the game, but not all of the subsidiary characters,' she continued. 'It is still at the planning stage.'

The game will run on machines from Apple, Atari, Commodore, IBM and Tandy. It will be available in the US from November, but UK fans will have to wait until 1984.

SINCLAIR POP

Who would have thought that Clive Sinclair could affect the pop music world? Chris Sievey and Pete Shelley are two musicians who have turned to his micros.

Mancunian Chris Sievey is the man behind the world's first computer-game pop single. The record was released in May by EMI, and the cassette in June. It features a song called 'Camouflage' on the A-side, and three programs for the ZX81 on the B-side.

When you play the B-side, all you hear is a series of bleeps. When you play it into a ZX81, the program will load into the computer's memory.

Once loaded, you can play the A-side. The lyrics to 'Camouflage' and various graphics will be displayed on your TV in sync with the song.

An arcade-type video game called Flying Train is also on the B-side, in both 1K and 16K versions.

With 750,000 ZX81s sold in Britain, EMI have obviously realised that the people who 10 years ago provided the biggest market for pop records are now buying computers and computer games.

'Camouflage' sells for about one fifth of the price of games cassettes. EMI hopes that Sievey's effort will 'revolutionise the music and home computer industries'.

Pete Shelley's XL1 Plus Dub Mix album is for the Spectrum. Working in one of the top computerised recording studios in this country gave him the idea of writing a program on one of his albums.

When the music for XL1 had been recorded, Shelley

and a friend worked out a program for the 48K Spectrum. They put it on the last track of the album. This is loaded in a similar fashion to Sievey's record.

The album is also sold with a cassette.

'People are very scared that the music may be copied,' said a spokesman from distributor Island. 'We are not suggesting that.'

'We are suggesting that they actually buy the cassette.'

The cassette was released at the end of June. It sells at approximately £5, the price varying regionally.

'We did it because the artist wanted to do it,' replied Island's spokesman when asked about future plans for more albums.

'But we would not be against doing it in the future.'

FOLLOWING A NEW CULT

Newcomers to the software market now include Virgin, the multi-million pound music business.

Virgin is launching eight games initially. They are for the Spectrum, BBC and Vic 20 and retail at £7.95. The company promises a new approach to marketing games software, and high quality in the games themselves.

Like the rock industry 10 years ago, the computer games market now is young, huge and lucrative. Virgin is pushing its program authors as cult figures. Each cassette comes with a description of its author and a passport-style mugshot.

Sheepwalk is Virgin's offering from Gregory Trezise, an 18-year-old, A-level student. It is one of the best

games around for the Spectrum. In it, you are a dog whose brief is to round up sheep without drowning them or destroying crops. It should be a big success.

Other Spectrum games are Yomp and Starfire, involving the now flogged-to-death themes of crossing a busy road and last-human-against-the-aliens respectively.

Our review copies had a few bugs; we hope that Virgin have managed to squash them before public release.

With each game bought before 1st September, Virgin has two freebies. The first is one year's membership of the Virgin Games Gang.

The other is music by Steve Hillage on the second side of all cassettes.



SPECIAL
REVIEW

8

INVESTMENT PACKAGE

AT 17, RICHARD JONES HAS LAUNCHED THREE SUCCESSFUL COMPANIES. DEIRDRE BOYD ASKED HIM WHY HE CHOSE THE COMPETITIVE COMPUTER GAMES MARKET

Richard Paul Jones is a 17-year-old whizz kid. He is sole proprietor of two successful computer-related companies which are building up solid profits and a solid reputation. They are expanding week by week. Then he will look for something new, another interest. He wants to make money. Paradoxically (depending on how much of a capitalist you are), he seems to be doing it with ethics.

I met him at Commodore's annual computer show in London's Cunard Hotel, where his exhibition stand was arguably the most eye-catching. Brightly coloured and fast-moving screens were generously dotted about, tempting passersby from 10 years old and up to play.

There was the old favourite, Frogger, with diving turtles and plenty of vehicles to run you down. There was Crazy Kong: 'the ape has captured Mario the carpenter's girlfriend and has taken her to the top of a steel fortress. You must get Mario to the top to save her!' Both of these were written by 15-year-olds. There was Jupiter Defender, amazingly written by an 11-year-old, Scramble and Panic.

The bunches of people around each machine were testimony to the popularity of the games. How did it all start?

Richard Paul Jones was born on 28th July 1965 in Rinteln, West Germany. His birth sign – Leo, the leader – was a good indication of the career he was to carve.

He was educated in West Germany and Hong Kong, where his father's work brought him. He then spent nine months in Northern Ireland where he studied for, and got, seven O Levels. Four A Levels were offered, but he refused them, finishing school at 15.

'My father stayed in Northern Ireland just so I could finish my exams,' Jones said. 'We returned to England at the end of June, as soon as I finished my last one.'

He then worked part-time in a hi-fi and video shop. He had the chance to get into the marketing side but had to turn it down: by law, he could not work until the end of July because he was not yet 16.

'My parents were looking for something to set me up,' Jones explained. 'I was motivated and they knew it. I did not want to work in my mother's haulage company. If I had stayed in the hi-fi shop, I would probably still be there, maybe repairing equipment.'

His father had put some money aside. Jones used it to start up a video cassette library. He had 100 tapes.

In December 1981 he moved into a shop. 'Now I have 2,500 tapes and two people working for me.'

'All the takings were invested back into the company, and this is still going on. Everything earned goes back in to buy programs and pay staff.'

Jones launched the now-famous Llamasoft software company when he was 16, from the takings generated by the video cassette shop. It was a whirlwind affair.

'I decided to form a partnership with programmer Jeff Minter,' he said. 'I funded it and Jeff was to program the games.'

'The way I met Jeff is that I bought – or rather, I ordered and built – a ZX81. I built mine before Jeff did; he

started with a ZX80. He was good at writing programs. I was interested in games. I was a freak at that stage.

'I saw Jeff's potential. We were hobbyists. Then we bought a Vic 20 each. He really started shining – he was very much into it. We went to an exhibition, looked at magazines. And I could see the potential in his games compared to those.'

'He was a bit dubious about coming in with me at first. But our partnership must have worked out. Jeff's got a thriving business now.'

Jones made the decision three weeks before Commodore's show last year, which made this year's show Llama-

Then unexpected troubles began.

Jones had been doing all the marketing and administration. But his 50% share in the company meant that Minter had to be consulted on every one of his decisions. For an individualist like Jones it felt like a frustrating straightjacket.

He had been placing advertisements for programmers. They came in with some extremely good demonstration tapes, which he wanted to market. But Minter refused to deal with them, wishing to remain Llamasoft's sole programmer.

The split was inevitable. 'We were incompatible,' Jones said. 'He thinks I

**'EVERYONE GETS
PAID WHAT THE
PROGRAM IS WORTH.
I HAVE NEVER
RIPPED ANYONE OFF.'**



soft's first anniversary. He managed to get a cancelled exhibition stand on the second day, and so Llamasoft was thrust into an eager market.

'We had a stock of 80 cassettes to take to the show and sold most. The show alone cost £600. But 10 days later we had an order for £3,500 worth of games – about 600 games,' Jones said. 'I had put about £1,000 into selling the whole lot. We thought we were on to a really good thing.'

The duo bought their first piece of equipment for £1,100. They made what Jones called a 'reasonable profit'. This again went back into the company. Things continued in this fashion from June to September 1982.

am a capitalist.' That was September of last year.

Jones remains loyal to Minter's skills. 'Jeff has quality. He is a fantastic programmer. He is a classic example,' he praised. 'I don't feel that way: I just feel I am giving value for money. Certainly, the quality of my games has gone up and up and up. People think the software is as good as Jeff's, but not better. The advantage is in the packaging and marketing.'

The split was followed by two months of research as Jones investigated how to set up the company he wanted. 'This involved going back to the stuff I was sent when with Llamasoft and contacting other people, too.'

Some stuff was good, some not. Obviously I have my own authors now,' he said.

Not one to be inactive, the two months of research were also spent independently developing a joystick for the Spectrum.

He named the new company Interceptor Micro's in December 1982. 'I placed my first ad, a full page. I spent £500 on that ad. I made a profit. I placed more ads. Now I place spot-colour ads in four monthlies. And I will use full colour later on.'

The professional attitude to marketing seems strange from someone still at an age when most are at school. 'I

younger than me.'

As with all his previous enterprises, Jones invested any money made from Interceptor Micro's back into the company. 'In November I had only two games. Now I own the rights to 21 or 22 programs - world marketing rights. Six programmers are working from home. Some are students: the youngest is 11. My best selling game, Jupiter Defender, is written by him. The oldest programmer is in his 30s. He is a police officer. He bought an Atari for his leisure, created a game and sold it to me.

'I look at the games, see their potential. I work out what each is worth on

edges, so to speak, and come up with a marketable product. If I felt it was not value for money I would not market it.

'I have only recently put my own name on the covers of the games, under the programmer's name. Usually, I star the programmer. Most other people show their company, and do not advertise who wrote the game. Programmers appreciate recognition when they write a program.

'I have a secretary, called Carol. She is 18. At the bottom of all our ads, I have inserted "Any problems, ring Richard or Carol". So Carol gets more recognition, too. And her name is at the bottom of the letterheads as being the secretary.

'I think I am probably one of the only companies in England selling stuff and not making the profit everyone else is making. This is because I am spending so much money on packaging - not so much advertising, but the actual packaging. "Why are you packaging like EMI Video?" people ask me. Even the type of case I use - instead of using ordinary cassette cases, I went for a special video cassette package which is costing three times as much. But I am charging less than most.'

A quick look at Interceptor Micro's programs shows the truth of Jones' last remark. Six of the games for the Commodore 64 are £5, the remaining seven £7. And games for the Vic 20 range from £4 (for Frog) up to £6.

'Most of the art work I supply. I go independently to people who may be my age. I put feelers out. If someone comes up with a good thing, I pay for it,' Jones said.

The covers of Sprite Man and Panic were drawn by the sister of A. Challis (Jones never reveals the christian names of his authors), who wrote Frogger. 'Their parents think it is the best thing they have seen,' Jones enthused.

'I do my own packaging, my own duplication. When I broke with Jeff, I took the copier. Now I have another system which produces 300 copies in one hour. I do all this myself: I employ a full-time person who works 40 hours a week duplicating. I try to keep everything inhouse: copying, advertising, duplication.

'I seem to be giving too much back to the customer. I have been told I am an idiot. "Why charge £7 when you know it is worth more?" The games are better than some others.' I am too soft on the customer. But that will build up a good market share. They all come back.

'Someone - say a schoolboy with £5 per month pocket money - may order just one cassette. His father may send the actual cheque. Then a few weeks later I get another order from the same person. He's saved up his pocket money again, to buy another tape. A lot of other people do not have this loyalty. Their games are expensive,



do not see myself as a minor,' Jones argued. 'I don't think like a 17-year-old.'

Had he encountered any legal problems in being under 18? 'No,' he replied. 'I am trading as Richard Paul Jones Trading As Interceptor Micro's. I simply opened a bank account, placed my first ad, and that was it.

'VAT is my first hurdle. I must register for that. When I set up the video library, I did register for VAT. The government doesn't care that I am a minor. It is just glad to get the money.

'I have a legal contract for all purchases of copyrights. I am well covered. Anyway, most of the programmers are

the retail market. I do not discriminate about age - everyone gets paid what the program is worth. I have never ripped anyone off.

'This has paid. As you can see from the tapes, some programmers have given me four games. They have enquired elsewhere but they do not get any more. They may get promises but nothing comes of it. So they come back.

'I do not enjoy programming - that's hard work,' Jones continued. 'But I do enjoy this. I enjoy talking to the programmers and saying what I want.

'I may want a version of Panic, which is already in the arcades. The programmers rough an idea. I smooth the

and some users feel they have not got their money's worth.

'I do not reckon it is the best software in the world,' Jones deprecated. 'But it is value for money. I do not market rubbish - it would ruin the name I am building now.'

The company is getting to the stage where even Jones' parents are helping out. His father is working on the exhibition stands this year. 'I need more staff because I cannot cope,' Jones said. 'The market demand is growing so quickly. The people that were small - wholesalers, etc - and ordered small quantities from me are now ordering more because they have grown. The shops are sold out of cassettes almost as soon as they appear. Which is good, really.'

Commodore itself has got into the act. It is currently advertising seven of Interceptor Micro's games in VicSoft, Commodore's Vic 20 user catalogue.

'Frogger is just for the UK market,' Jones said. 'They are all arcade clones, arcade rip-offs. They are a problem because you cannot sell them in the US where copyright rules are stricter. I am selling Puckman, for example, on Atari's Pac Man advertising.'

'Because I cannot find an international market, I am bringing out more original software. At the moment, I can only sell in the UK. When I showed Frogger 64 at a computer show in America, I was told to turn it

'MONEY CANNOT BUY PROGRAMMING SKILLS BUT IT HELPS. IT BUYS THE EQUIPMENT TO DEVELOP THOSE SKILLS'

off immediately. The dealers were afraid of a law suit if they showed it for even just a few minutes. "Come up with original software, or we can give you ideas to develop into games," they said.

'Jeff is now writing for an American company. They are using English brains because he is the best. Now they are looking at my stuff, which is coming up to the same sort of standard. But it is not the right sort.'

Jones is looking for a freelance machine-code programmer 6502 or Z80. 'I feel there are many people out there as good as Jeff if only they could be developed right. There are people who are as good - or better - than anyone else in the world. But they do not have the equipment, the facilities.

Money cannot buy programming skills but it helps. It buys the equipment you need to develop those skills.

'As far as wages go, the only thing I have had from the company is my trip to America. I do not take a wage. I don't take a wage from the video shop, either. I probably live on £20 a week - sounds ridiculous, doesn't it? I don't drink, I don't smoke, I don't socialise.' He paused. 'Well, not much.'

'My prime interest in life is to make money. Maybe I will retire early. I am a weird sort of character. I have just come back from Florida and Chicago, where I saw the Consumer Electronics show. I found more enjoyment walking round Chicago, which is a grotty place, than having a rest on the beaches of Florida or going to Disneyworld. That's because I am fascinated with electronics. It is not work to me.

'I would like to retire at 25. If you have enough money you cannot get bored. People say that if you are rich you are unhappy. But if you are poor you can be unhappy, too. I would probably still own the businesses, even when I have retired.

'I see my role like that of a bloke who runs a record company, except I don't rip people off. I could have been stingy - bargaining with programmers, being mean with the packaging - and made more money. But I would not have their respect.'

SPECIAL REVIEW
12

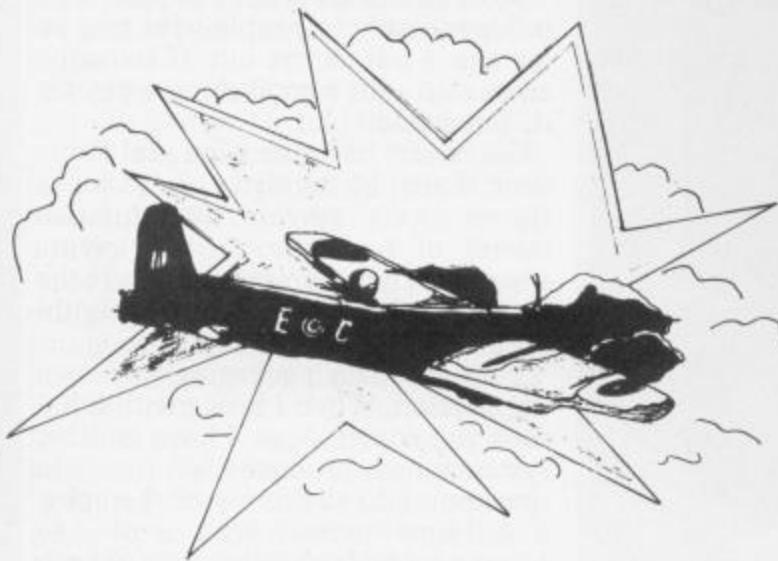

DAMBUSTERS!

Can you stop them?

Protect your dam from wave after wave of enemy bombers. Different skill levels, stunning graphics and sound. A colourful arcade style game for the Atari 400/800 with 32K or 48K (Please state which.)

£14.50 (inc. VAT + P&P)

Available only from:

D. FROST SUPPLIES LTD

34 Field Road, Reading. (Cheques & P.O.'s only)

Dealer enquiries welcome

TWILLSTAR COMPUTERS

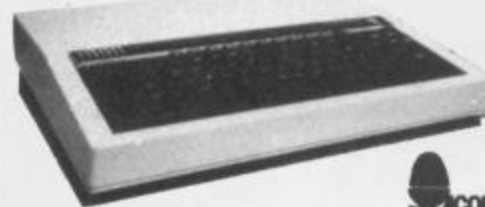

BBC

BBC MOD A 299.00
BBC MOD B 399.00
DISK DRIVES 100K
ONLY £195.00 + VAT
DISK INTERFACE
ONLY £95.00 + VAT



COMPLETE RANGE OF SOFTWARE FROM BUGBYTE, PROGRAM POWER, IJK, A&F, ACORNSOFT

Missile Base	(Acornsoft)	£9.95
Snooker	(Acornsoft)	£9.95
Starship Commander	(Acornsoft)	£9.95
Countdown to Doom	(Acornsoft)	£9.95
Castle of Riddles	(Acornsoft)	£9.95
Rocket Raid	(Acornsoft)	£9.95
Sphinx Adventure	(Acornsoft)	£9.95
Chess	(Acornsoft)	£9.95
Creative Graphics	(Acornsoft)	£9.95
Tree of Knowledge	(Acornsoft)	£9.95
Business Games	(Acornsoft)	£9.95
Peeko Computer	(Acornsoft)	£9.95

and many others from full range of Acornsoft including educational software.

BUSINESS SOFTWARE

Home Accounts	(Gemini)	£19.95
Commercial Accounts	(Gemini)	£19.95
Stock Control	(Gemini)	£19.95
Mailing List	(Gemini)	£19.95
Invoicing & Statements	(Gemini)	£19.95
Database	(Gemini)	£19.95
Beebcall	(Gemini)	£19.95
Personal Money Management	(Beebsoft)	£8.95

COMPUTER BOOKS & ELECTRONIC MAGAZINES SOFTWARE, HARDWARE SUPPORT/SERVICES/RENTALS

CALL IN FOR FURTHER DETAILS

TWILLSTAR COMPUTERS LTD

17 REGINA ROAD, SOUTHALL, MIDDX

TEL: 574-5271 (24 hours)

OPEN 10am-8pm SIX DAYS A WEEK



Solons of Space

Masters of The Game

SOFTEK

Joust



Galaxians
Oric

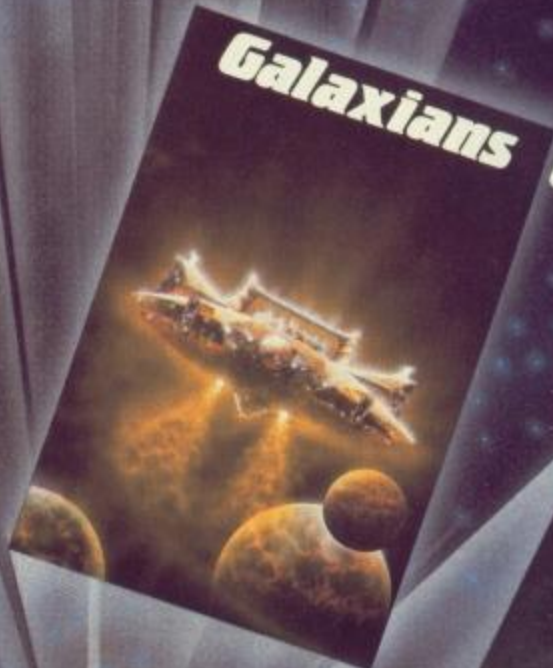

Dragon 32



Repulsar



Firebirds



Robon



Six new stars in the Software Universe. All of the Softek range should be available in most High Street shops such as W. H. Smith, Menzies, Boots, Dixons and through our Nationwide Dealer Network. Or direct from us at:



329 CROXTED ROAD, LONDON SE24
01-674 4572
Dealer enquiries: contact Tim Langdell

Joust You, White Knight do fly upon your Ostron and do battle with the Dark Lords upon their Buzzards. The most amazing hi-resolution graphics and movement ever on the ZX Spectrum. 16 or 48K RAM. £5.95 Realisation: Andrew Glaister.
FIREBIRDS Wave after wave of Firebirds and their cohorts the Blue Weavers and the White Bombers; ever chasing the Firebirds' Motherships. Unlimited waves and specially crafted machine coded super-smooth action and sounds sets a new standard in shoot-em-up games. Runs on any ZX Spectrum. £5.95 Realisation: Graeme Devine.
REPULSAR The last outposts of Mankind are under almost constant attack and you alone have control of the defense system. Fast and furious version of the arcade game Missile Command. Works with Joysticks. Any ZX Spectrum. £5.95 Realisation: Andrew Beale.

GALAXIANS The first 'arcade perfect' version of the popular game, written in machine code for super-smooth fast action play. Hi-res movement and superb sound effects make this the game other Oric games will be compared with. £6.95 48K Oric; 16k other Oric games. Realisation: Gordon Russell.
MONSTERS Don't PANIC! Alone in the maze of platforms and ladders on Saldon III you must find power-modules in the system guarded by the Monster-Robots. But you have your Laz-Gun to blast through levels and send them crashing to their fate. One of the best 100% machine code games yet for the Dragon 32. £7.99.
ROBON Quite simply a quantum leap better than other versions of 'Berserk' for the Spectrum. Nine levels of play, and full feature action including Robon chases, laser guns, and if you dally too long the Robok will get you! Any ZX Spectrum. £5.95 Realisation: Andrew Beale.

DON'T JUST STAND THERE...



USE THE FAST LANE

28th September-2nd October Barbican Centre, City of London

The PCW Show is Britain's most popular micro event. Hardly surprising, with over 200 exhibitors showing an exciting range of micros, software and peripherals — for business and commerce, education, science, industry and the home.

But if you use a micro at work

(or are thinking of buying one) you can avoid the crush. Just clip the coupon below and send it with your business card and a cheque for £2.00 (normal price £3 at the door!). We'll send you a special "Fast Lane" ticket. And you won't have to play the waiting game.



28th September-trade only
Entrance by invitation

THE FAST LANE

Please send me one "Fast Lane" ticket to the 6th PCW Show.
I enclose my business card and a cheque for £2.00 made payable to the "Personal Computer World Show".

NAME.....
ADDRESS.....

Send to Amanda Stephens
PCW Show, 11 Manchester Square
London W1M 5AB

PROGRAM CONTROL GUARDIANS

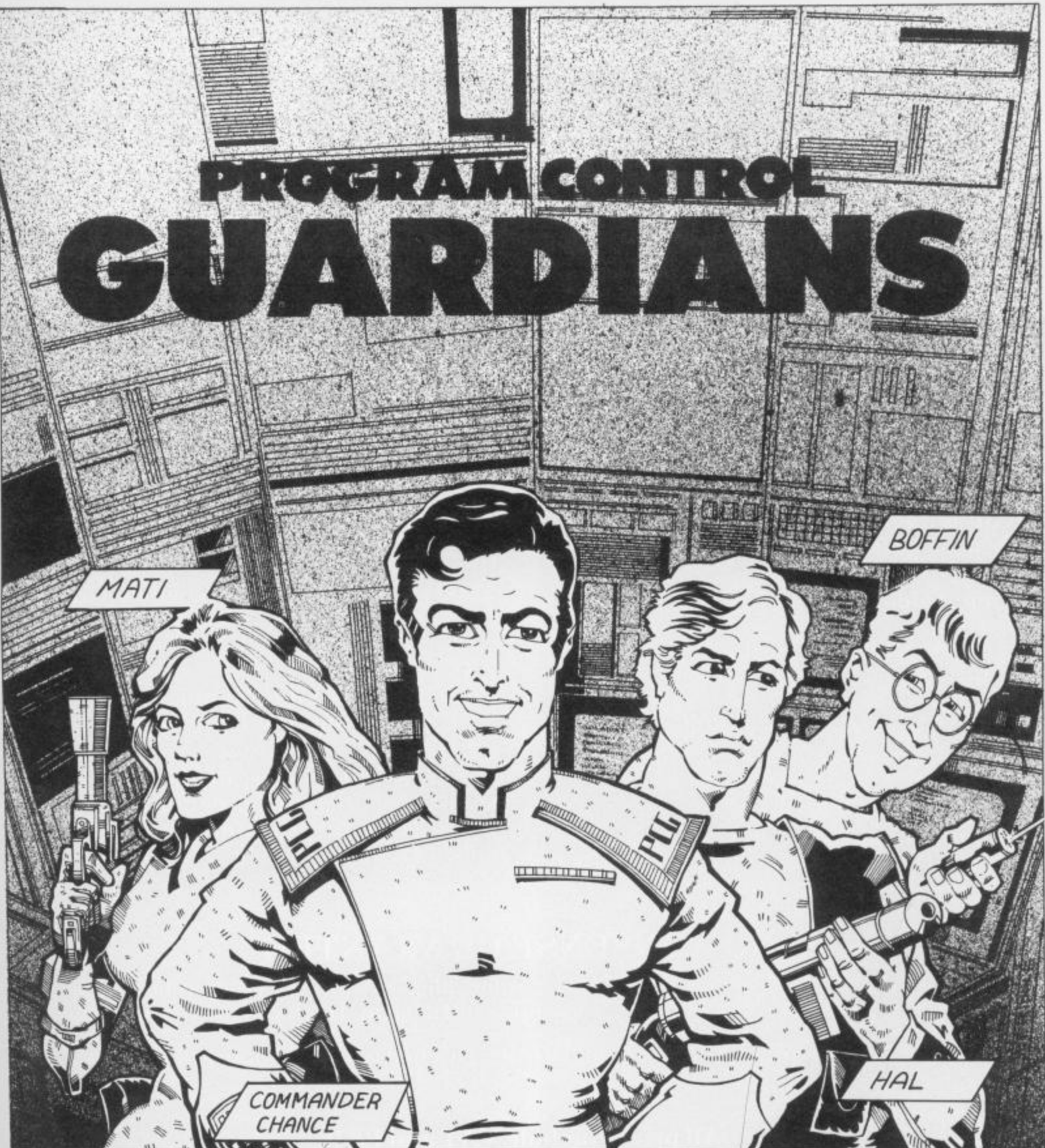

MATI

BOFFIN

COMMANDER CHANCE

HAL



THE PCC'S PROTECT THE WORLD FROM ROGUE GAMES

THIS WAY WE CAN EVALUATE THE GAMES 'PLAY' RATING.

SO WE PLAY THEM FROM THE INSIDE..

TRANS-MUTE!

AND IF IT DOESN'T RATE, WE PUT THE BYTE ON IT

Animation by Jef Riddle



How can you pass up a good program?

Well, we couldn't, so we are now able to offer you good quality programs for the following computers: Dragon 32, Spectrum 48K, TI99-4A, and ZX81.

DRAGON 32:

Scanner 13: Set in the city of the future, this game combines the best of arcade and adventure games. £8.45.

Alien Oddesy: First two parts of an exciting new adventure game. Escape from the castle, and begin the flight from your captors. £9.95.

TI99-4A:

K-64: A game requiring patience and forethought, can you cover every square of a chessboard using the Knight & his legal moves? £6.50.

Alone at Sea: Your ship is sinking and you must escape, but you must find and carry provisions, and other items. £6.50.

SPECTRUM 48K:

Mystery Manor: Based on the game of Cluedo, this will really keep you on your toes to dodge the murderer. £6.50.

Master Code: Beat the computer in this challenging game of colour guessing. £6.50.

ZX81:

Treasure Island: Cannibals and nasty birds are among the hazards in this neat program. £5.95.

Spelling Tutor: For all those who have trouble spelling, this program will be very useful. You can program it for any level of difficulty, and it includes a game as well. £5.95.

NO NONSENSE GUARANTEE

For further details of these programs, or to order, please fill in the coupon below, or ring us on 085-982-313 or 239. Phone lines are open until 9 p.m. Dealer enquiries welcome.

All programs are in stock now, and are despatched within 48 hours of receipt.

All prices include VAT and P&P.

Name: _____

Address: _____

Signed: _____

I send cheque/P.O. for the sum of £

Please send me

Total £ _____

Please debit my Access Account

--	--	--	--	--	--	--	--	--	--	--	--	--	--	--	--	--	--	--	--

Send to: Bamby Software, Leverburgh, Isle of Harris, PA83 3TX. Tel 085 982 313

P.C.G.1

GET CRACKING!

**HAVE A CRACK AT OUR NEW COMPETITION
AND WIN AN M5 HOME COMPUTER.**

**Beat the software houses at their own game and
write an original graphics adventure.**

Programming for computer games is improving by leaps and bounds. Every machine plays games written not just by software houses but by users from nine years old upward. But there are now so many games about that the producers seem to be running out of ideas. Soon the success of a game will depend on the design underlying it rather than programming skills.

After a wave of Froggers, Flight Simulations, Pacmen and Donkey Kongs, the software houses are turning to the classics for inspiration. Adventure games are centred round Tolkien's *The Hobbit*, Carroll's *Alice in Wonderland*, even good old Dragons and Dungeons.

So here is a competition open to all our readers, whether you have programmed before or not. Let your imagination go wild and write an adventure. DON'T base it on a book or Dragons and Dungeons. The more tortuous and twisted it is, the better. Touches of humour are always appreciated. If there should be a tie, the adventure with the most detail will definitely have the edge.

The reward for the best adventure is a CGL M5 Home Computer worth £190. Newly released, the CGL M5 home computer package gives you everything you need to start playing immediately.

GRAPHICS

There are four graphic modes which allow:

- * 24 rows of 40-column text
- * 768 user-definable characters of up to 16 colours each
- * 16 colours on the screen at any one time
- * 2 separable screens
- * 256 x 192 resolution, fully dot-programmable
- * view port facility
- * separate graphics memory
- * 32 sprites, selectable from 256 separable user-definable characters

SOUND

- * Three programmable tone generators
- * Programmable white noise generator
- * Programmable attenuation
- * Simultaneous sounds

The CGL M5 has a Z80A CPU (3.58 MHz), 20K RAM (16K V RAM) expandable to 52K and 16K ROM expandable to 24K. But its graphics and sound make the M5 ideal for games enthusiasts.

The animation is jitter-free and the graphics on a par with the arcade machines. The sound incorporates a 'mini-synthesizer' which can give you three separate voices with six octaves.

All entries must arrive at the following address by 31st August 1983: The Editor, *Personal Computer Games*, VNU Business Publications, 62 Oxford Street, London W1A 2HG. The judges' decision is final and no correspondence will be entered into.

The Autumn issue of *Personal Computer Games* will feature the winning adventure. And we will be offering another super prize to the reader who comes up with the best program for it.



THE PRIZE FOR THE MOST ORIGINAL ENTRY

The winner will receive a package that includes: * CGL M5 Home Computer console (262 x 185 x 36mm, 800 grams) * Power supply unit * TV connection cable * Cassette recorder cable * Basic I cartridge * User's guide * Basic I manual: *Easy Basic For Beginners* * Demo cassette tape, with two games.



SPECIAL
REVIEW
18

BOOSTERS

**PERIPHERALS CAN BOOST YOUR MICRO'S POWERS
AND YOUR FUN. TONY HARRINGTON HAS SCoured THE
SHOPS FOR YOU**

There seems to be a new microcomputer on the market every week. But that is as nothing compared to the rich growth now taking place of computer peripherals of all kinds.

You may want the freedom of a joystick for reflex-type games. Or you may want additional memory or processing power. In every case, there is bound to be at least half a dozen suppliers eager to offer their wares.

The ideal way of doing a peripherals round-up is to group what is available for each brand of home computer. But many suppliers offer add-ons for more than one kind of micro, so the list becomes repetitive.

In the first of our series of peripherals, therefore, we have listed the suppliers. The names of the micros are highlighted when the peripheral concerned is specific to a particular machine.

First in our list is Flight Link, which is based in Alton. It makes three ranges of joystick, suitable for a wide range of micros. The first model in the range is the J1. This has dual axis carbon track controls and comes with or without cases, switches and cables.

The second, JS2, has high-quality, all-metal dual controls. At the top end of the range, which will be outside the pocket of most micro-enthusiasts, is the JS4. It has inductively coupled contactless joysticks.

This firm takes the business of making joysticks very seriously. It pays a lot of attention to unique demands, such as the control of puppets or the movement of vessels under water. Its products range in price from £3 to a staggering £1,000.

Akhter Instruments, based in Harlow, also has a range of peripherals. In particular, there are three types of green monitors: the Hitachi MM1216 at £102.35; the SM12H 18MHZ monitor at the same price, and the cheaper, if less powerful SM12N 15MHZ at £79.35. All prices include VAT.

The company also offers 14-inch colour monitors whose prices range from £239 plus VAT for the normal resolution of 400 dots up to £499 plus VAT for the high-resolution 800 dots screen.

SIR Computers, from Cardiff, supplies a Z80 disk pack for the BBC Micro at £895. That sounds steep, but the system aims to be a sophisticated development of the machine's potential.

It connects to the BBC micro in the same way as a normal disk drive. It then opens up the whole range of CP/M software for business and dataprocessing as well as games. This is because the firmware supplied with the machine allows you to switch between Basic and CPN, an operating

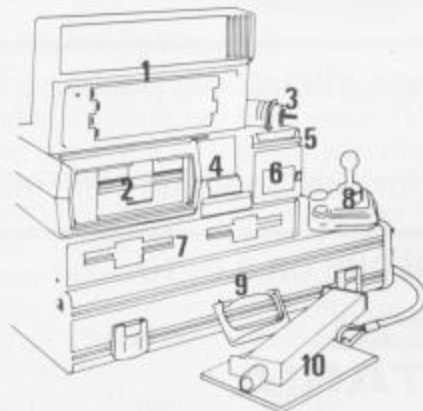

Key. 1: ZX81 keyboard. 2: Atari disk drive. 3: Flight Link joystick. 4: Sinclair 16K RAM pack. 5: Dragon 32 sound module. 6: BBC Hobbit storage unit. 7: BBC disk pack. 8: Kempston joystick. 9: Spectrum microcase. 10: Securit anti-theft device.



MYSTERIOUS ADVENTURES



FOR BBC MICROCOMPUTER MODELS A & B

Join the growing band of Adventurers who are enjoying these absorbing and stimulating programs. Step into another world of Fantasy, Magic, Mystery and Sorcery. Only your wits and cunning can ensure success in these scenarios!



● WRITTEN IN ULTRA-FAST MACHINE CODE.

● SAVE GAME FEATURE.

● SPLIT SCREEN DISPLAY.

1. **THE GOLDEN BATON** — Venture into a strange province of Sorcery and Evil Magic to recover the Golden Baton, a priceless artifact whose powers are said to bring great Health and Prosperity to the Land.
2. **THE TIME MACHINE** — As a Newspaper reporter you are sent to investigate the eccentric professor who lives in the old house on the Moors. What is his secret and why is his house now deserted?
3. **ARROW OF DEATH (Pt. 1)** — A blight has fallen on your homelands, the Baton has become tarnished and now radiates a malevolent aura of Evil. Your mission is clear — trace the source of this Evil and destroy... or be destroyed. This is the first part of an Epic Adventure although each part can be played as a stand alone scenario.
4. **ARROW OF DEATH (Pt. 2)** — You now have the means to destroy your enemy... but you are far from home and this land is strange to you. Can you cope with the deadly perils which approach you and have you the strength to see your mission through to the final conflict?
5. **ESCAPE FROM PULSAR 7** — Alone on a gigantic Space-Freighter... The rest of your crew have died horribly at the hands of a mutated Zoo-Specimen. Your only chance of escape is to reach the Frail Shuttlecraft. But the lurking Monster is hungry and you are the only food it has left...
6. **CIRCUS** — Your Car has run out of Petrol on a lonely road miles from habitation. As you trudge reluctantly down the road in search of help you are suddenly confronted by an amazing sight... In a nearby field is a Huge Circus tent! But this is no ordinary Circus as you will soon discover...
7. **FEASIBILITY EXPERIMENT** — Far across the gulfs of time and space, a dying race of super-intelligent beings search the Universe for a Hero to save their existence... At length their thoughts turn to planet Earth. You are chosen to be their saviour in a bizarre scenario where death is a mere thought away...
8. **THE WIZARD OF AKYRZ** — You are in the Royal Palace. The King beseeches you to rescue his daughter from the evil wizard. If you succeed your reward will be priceless... failure will bring certain death.
9. **PERSEUS AND ANDROMEDA** — Travel into the realms of ancient mythology. Battle with grotesque monsters and supernatural powers as you search for the hidden secrets of myth and legend.
10. **TEN LITTLE INDIANS** — This mystery begins with a train journey into a strange country. What secrets are held by the strange country mansion? What meaning is attached to the strange idols? Maybe you will find out if you live long enough...

Each adventure comes attractively packaged for just £10.29 inc.

Available now for 48K Spectrum, Hi-Res Graphics



SEND CHEQUE OR P.O. TO:

DIGITAL FANTASIA

PCGI, 24 NORBRECK ROAD, NORBRECK, BLACKPOOL, LANCASHIRE.
Tel: (0253) 591402



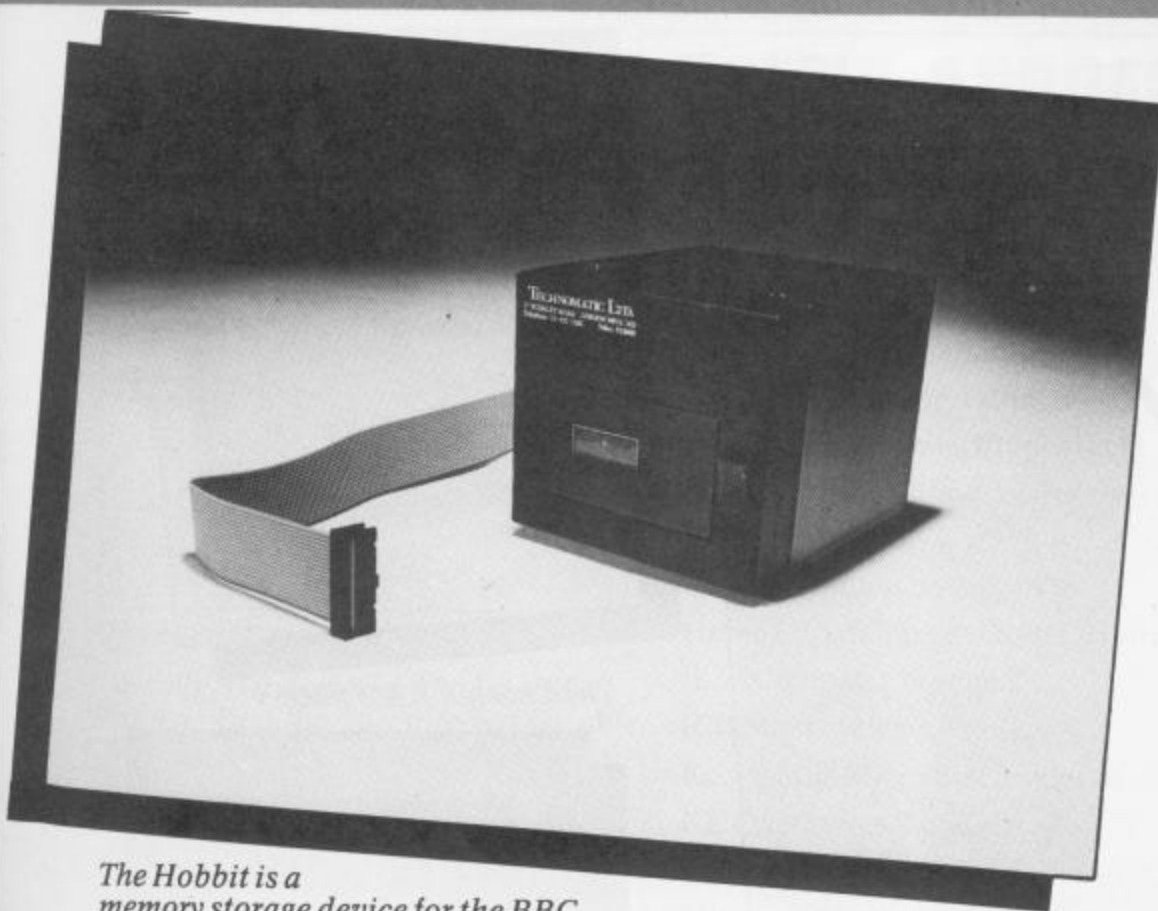

The Hobbit is a memory storage device for the BBC

19 system developed from CP/M 2.2.

The disk pack also, of course, provides a dual 2 x 400K disk drive for use with the standard BBC Basic. The machine is able to run CP/M because it includes a Z80A processing card with its own 64K RAM card, which communicates with the 6502A in the BBC computer.

The supplier claims that, in most cases, the speed of execution of programs is improved by up to 50% compared to conventional single processor computers.

Computer Concepts has had considerable coverage for its Wordwise ROM-based word processor for the BBC micro. The price is £39 plus £1.50 for postage and packing; VAT is on top of that. The 'chip' plugs into one of the empty sockets inside the machine.

It is supplied with a spiral-bound manual and a cassette which contains an example document and a free Typing Tutor program.

Basingstoke supplier Fox Electronics offers the Vixen RAM cartridge for the Vic 20. This cartridge is switchable between 16K or 8K and 3K. It plugs into the rear expansion port and should be fully compatible with all motherboards and modules. No readdressing of existing Basic programs is needed. The price is £39.95.

The same supplier also offers a 42-key travel keyboard for the Spectrum. You are supposed to be able to remove the ZX printed circuit board from your Spectrum and simply screw it down into the keyboard case. The supplier promises that no soldering is required. This costs £31.95, including postage and packing.

There is also a ZX-Panda 16K RAM pack for the ZX81. This is expandable

to 32K with a plug-in module from the same supplier. It includes a LED power indicator and is designed to connect without risk of the wobble that plagued the early Sinclair RAM packs. Prices range from £19.95 to £46.00 including postage and packing.

For users who don't like the standard ZX81 keyboard there is a replacement keyboard with a calculator-type design. This is a stick-on replacement and is priced at £9.95 from Filesixty.

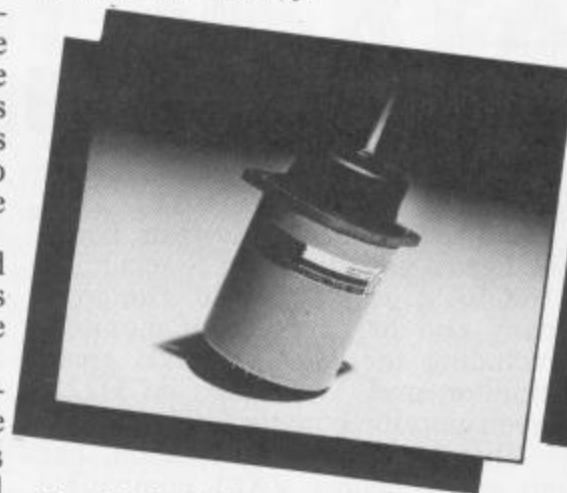

The Flight Link joystick

Those of you who are being slowly blinded by the glare from your TV set being used as a monitor might like to try out the effects of antiglare screens. Merseyside firm Datatel Business Products offers a range of antiglare screens which give a sharper, clearer image and cut down eyestrain. The price is £19.95 plus £1.80 for postage and packing.

Datatel Business Products also makes a multi-purpose computer stand which has an all-steel construction. This comes as a self-assembly kit and there are two sizes: two foot and two-and-a-half feet in height.

KK Electronics, of London, has a range of colour monitors compatible with the BBC, Lynx, Oric, Acorn and all other computers with RGB.

The monitors have a 16-colour display plus a brightness control. There is also a quality sound amplifier with loudspeaker control. Prices start at £239.95, plus VAT.

A speaker which plugs into the microphone socket of the Spectrum and boosts the sound output is sold by Alan White, of Poole. The speaker comes complete with volume control and needs no soldering. It costs £5.50 inclusive of postage and packing.

If you are worried about thieves making off with your home computer, you can at least ensure that they have to go to the trouble of taking the table with them, thanks to a little device from Ofco Ltd.

Called Securit, the locking device fixes to the desk top without the need for any holes being drilled. It costs £29.95 plus VAT.

More and more games designers are adding complex sound routines to their offerings. But for those Dragon owners who reckon that the sound of their machines still lacks a little, JCB Microsystems offers the Sound Extension Model for the Dragon 32. The price is £34.95 including VAT.

The sound extension model looks much like an ordinary games cartridge and plugs into the Dragon's expansion port. Based on the AY-3-8910 sound chip, the module adds an extra command called MUSIC to Basic. The range of possible sounds is specified as numbers and characters.

A sound synthesiser as used by pro-

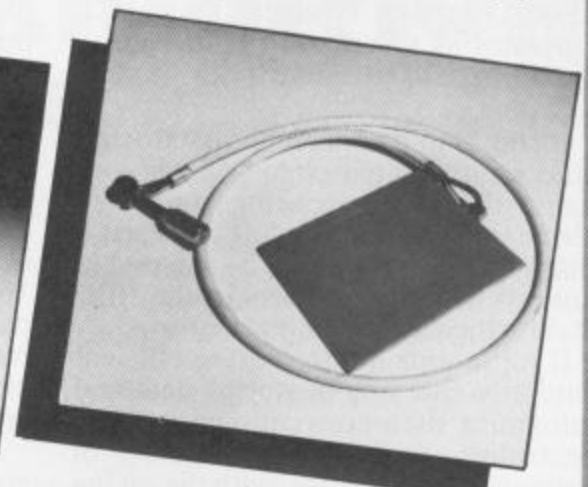

The Securit anti-theft device

fessional musicians this is not. For the price, you wouldn't expect it to be. But it will produce a creditable set of tunes and a variety of games noises from wailing sirens to bomb blasts.

The novice computer user will probably not have his (or her) machine long – and will run only a few programs – before the need for more memory becomes apparent. The BBC Model B, for example, has excellent ROM facilities, but has used up quite a bit of its RAM space accordingly.

BBC Micro users after more storage will find the quaintly named Hobbit tape system worth a look. Made by

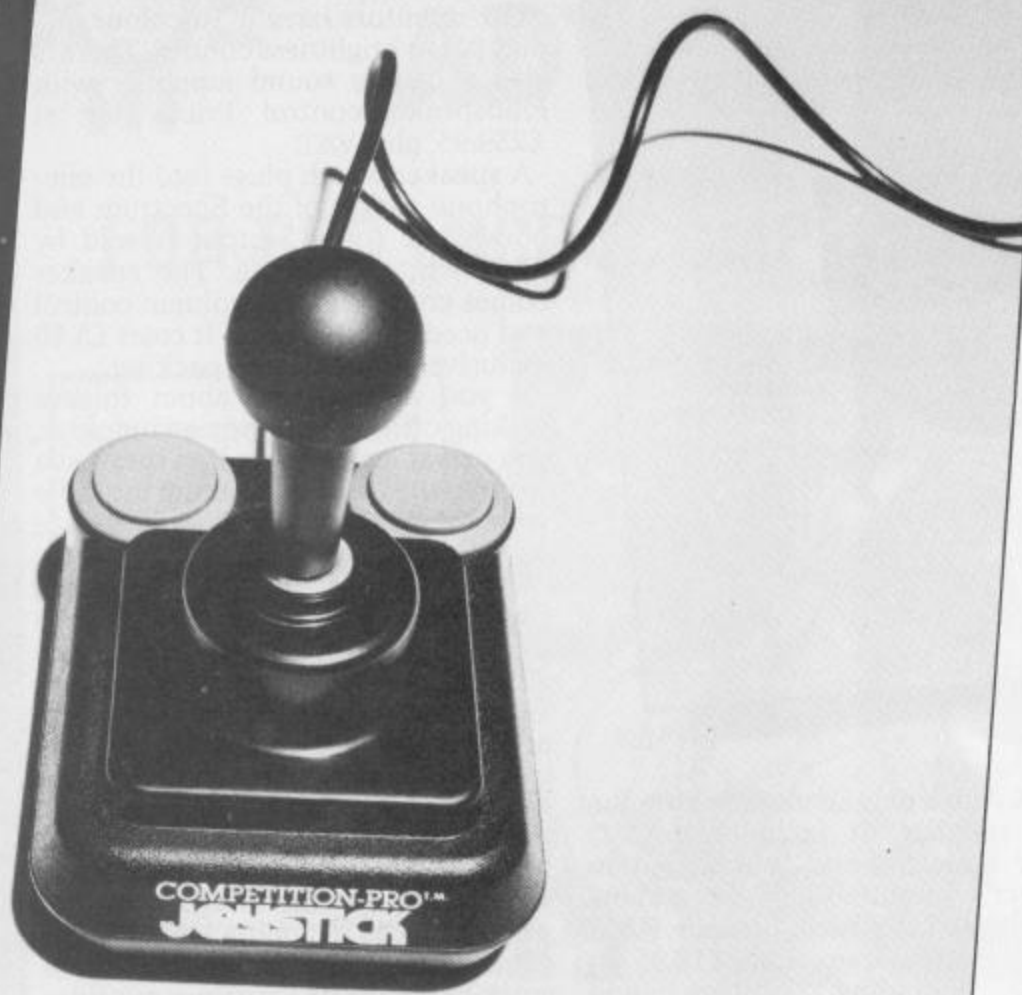

The Kempston joystick

21 Ikon Computer Products, the device operates as a sort of half-way house between cassette and disk-drive storage media.

It comes in two parts: a cassette unit and an integrated circuit which contains the tape operating system to drive the Hobbit. This last comes as a ROM card which has to be inserted in one of the three sockets in the BBC before the cassette unit can be used.

It represents a faster, more efficient and effective way of storing data and programs than conventional cassette recorders. And it has a number of commands which deal with the saving and loading of data.

The Hobbit cassette unit is about three and a half inches wide, roughly the same in height, and four inches deep. It weighs two pounds. Four large rubber pads on the base ensure that the equipment stays on the table instead of skittering off onto the floor.

The device has a data transfer speed of 750 bytes of data a second, five times faster than ordinary cassettes. The price is £135 plus VAT.

Kempston Micro Electronics has a joystick named the Competition-Pro for the ZX Spectrum. It is a nylon and steel construction, with a self-centering stick and two fire buttons. It

plugs into the Spectrum expansion port. You can buy it at WH Smith branches for £25 including VAT. The same supplier has joysticks for the VIC 20 and the Atari 400 and 800. They come at the somewhat cheaper price of £16.50 including VAT.

Microcell Computer Systems, based in Leeds, advertises the Sinclair ZX 16K RAM pack at £28.50. The company also has a range of monitors including the BMC BM12E green monitor and the Sanyo SCM12H green monitor, both for £100.

Cheetah Marketing, London, has an even cheaper ZX81 compatible RAM pack at £19.75 and the 64K RAM pack at £44.75. Both prices include VAT and postage and packing.

Warrington firm Micro Aids has hought up a way of allowing keen Spectrum users to take their machines with them wherever they go. The Spectrum/ZX81 microcase is designed to hold the computer, power supply, printer and rampack, with space left over for a cassette recorder or the fabled Sinclair micro drives.

The supplier advises that the shallow tray which contains the case can be used as an attractive desk-top console. And the detachable top of the

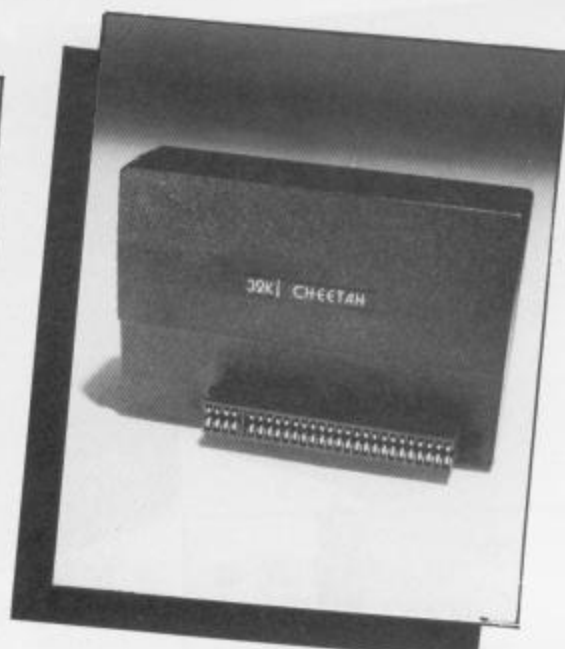

The Cheetah RAM pack

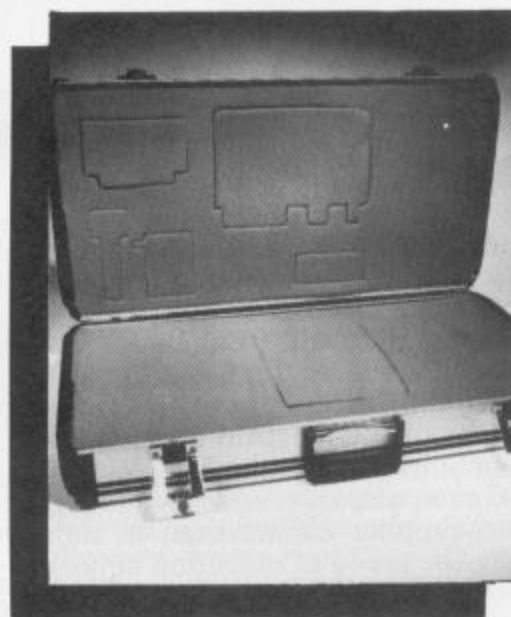

The Micro Aid case

case could be used as a TV stand. The price starts at £29.95, including VAT.

The Harrow-based firm, Home Entertainment Centre, has a number of add-ons for the Atari 400 and 800. In addition to joysticks at £14.95, there is a keyboard at £79.95, a 48K expansion at £99.95 and a disk drive at £289.99.

If you have wanted to make your micro talk back, the Namal Supertalker is a useful extra. It comes from Namal Associates in Cambridge. Priced at £89.95, it has an extensive built-in ROM/RAM dictionary and a standard RS232 interface.

It will run on a number of different micros. And as it is a phoneme synthesiser, it is not limited to particular words. It has been designed around the Votrax SC-01A phoneme speech synthesiser chip. You create words by using a sequence of codes to build words out of component sounds.

Up to 200 to 250 new words can be dumped into the device's RAM to add to the 550 high-usage words already stored in ROM. Special versions are available for the ZX81 and the Spectrum. These versions are memory mapped. In compensation, the price for these two models is £49.95, including VAT.



The Hobbit, ready to load

Finally, Hendon-based Vulcan Electronics offers the Spectravideo Quick Shot joystick. Similar to a helicopter joystick, it enables you to control and fire at the same time, with one hand. It has a rapid fire button on top of the handle. And there is an optional left-hand fire button at the base which can be used simultaneously.

As the Quick Shot comes with four suction pads, there is no need to hold down the base.

The Quick Shot joystick can be used for the Atari VCS system, Vic 20, Commodore 64 and Atari 400/800. It costs £11.95 including VAT.

USEFUL ADDRESSES

If you would like to know more about the products mentioned in this review, you can contact the manufacturers at the following telephone numbers. Addresses are supplied where no number is available.

Akhter Instruments, Harlow	(0279) 412639
Cheetah Marketing, London	(01) 240 7939
Computer Concepts, Chipperfield	(09277) 69727
Datatel Business Products, Merseyside	(051) 334 6369
Flight Link, Alton	(0420) 87241
Fox Electronics, Basingstoke	(0256) 20671
Home Entertainment Centre, Harrow	(01) 861 0036
Ikon Computer Products,	(099421) 515
JCB Microsystems, Poole	(0202) 423973
Kempstone Micro Electronics, Bedford	(0234) 852997
KK Electronics, London	(01) 317 1486
Micro Aids, Warrington	(092) 576 2613
Microcell Computer Systems, Leeds	PO Box MT12, Leeds 17
Namal Associates, Cambridge	(0223) 355404
Ofco, London	(01) 981 7301
SIR Computers, Cardiff	(0222) 21341
Vulcan Electronics, London	(01) 203 5161
Alan White, Poole	(0202) 682867



Everything for the Acorn and BBC microcomputer user.

ACORN USER EXHIBITION

Cunard International Hotel

Hammersmith,
25-28 August 1983



The Acorn User Exhibition at the Cunard, Hammersmith will house the largest display of Acorn products ever assembled under one roof. It will be four days of non-stop entertainment and education for parents and children alike.

The new Electron, the second processors for the BBC micro, the BBC Buggy, all the new software and hardware will be on show. There'll be competitions, prizes, Acorn experts to answer your technical questions, demonstrations and lots and lots of bargains.

If you are an Acorn owner, or just thinking about being one, you can't afford to miss it.

Opening hours: August 25th-27th, 10am-7pm; August 28th, 10am-4pm.

Admission charges: Adults £2 per ticket, Children £1 per ticket.

We have arranged for nearly every exhibitor to redeem the cost of your ticket when you buy something from their stand.

Group rates: 10% discount for parties of 10 or more.

Buses: Frequent services from central London.

Tubes: Hammersmith Broadway—Metropolitan, District and Piccadilly lines.

Car Parking: Several car parks in the immediate area.

For details of exhibition stands and advance ticket sales contact Computer Marketplace Ltd, 20 Orange Street, London WC2H 7ED. Tel: 01-930 1612.

ADVANCE BOOKING COUPON Miss the queue—buy your tickets in advance.

Computer Marketplace Ltd, 20 Orange Street, London WC2H 7ED.

Please send _____ Adult tickets at £2 _____ Childrens tickets at £1

I enclose a cheque/postal order value £ _____ payable to Computer Marketplace Ltd

Name _____

Address _____



TRY FIGHTING THESE WITH YO



OUR BARE HANDS.

Slot "Mutant Herd" into your VIC 20 computer and all of a sudden plutonium-crazed mutants will try to eat you alive.

Keep a look-out for falling boulders. They'll crush you to death at any second.

Avoid these successfully and all you have to do is save the world by destroying the heavily guarded Mutants eggs.

"Orc Attack" (on ATARI 400/800/1200) isn't exactly child's play either.

Imagine yourself standing on the battlements of a castle, defending your Kingdom against an army of ferocious Orcs.

Watch out for the hail of deadly crossbow bolts. You've only got two lives to lose.

And you've only got a few rocks, a sword and boiling oil to defend yourself.

Lose your head and you'll be decapitated.

If your hands aren't sweating after that try our other action packed titles.

There's "Fourth Encounter" (on VIC 20), an exciting new game with 3 skill levels.

The challenging "River Rescue" and "Music Composer" are also on VIC 20.

And to make the blood rush to your head the successful "Submarine Commander" is now available on VIC 20.

Or, if you've got ATARI 400/800/1200, there's the anxiety provoking "Jumbo Jet Pilot," as well as the best selling "Submarine Commander," "River Rescue" and "Kickback," all in the shops now.

Buy any one of THORN EMI Computer games and you'll have to fight off all your friends to use it.



The world's greatest computer games.

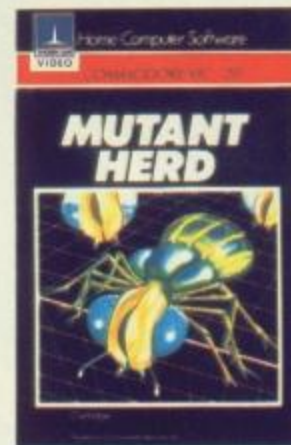

VIC 20

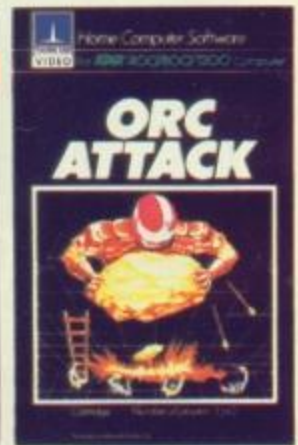

ATARI 400/800/1200

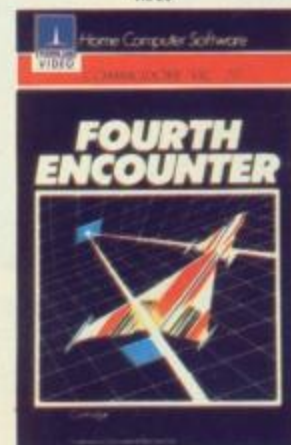

VIC 20

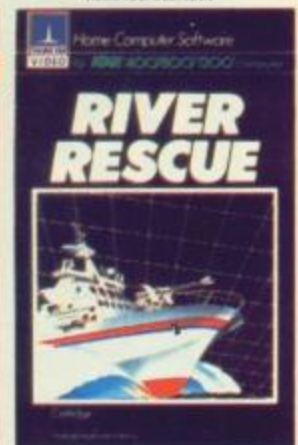

VIC 20/ATARI 400/800/1200



VIC 20/ATARI 400/800/1200



VIC 20



ATARI 400/800/1200



ATARI 400/800/1200

PROGRAMS FOR ATARI 400/800/1200 (Trademark of Atari Inc. except where indicated)
 - PROGRAMS FOR COMMODORE VIC 20 (Trademark of Commodore Electronics Ltd.)

MYSTERIOUS ADVENTURES

NOW FOR 16K ATARI

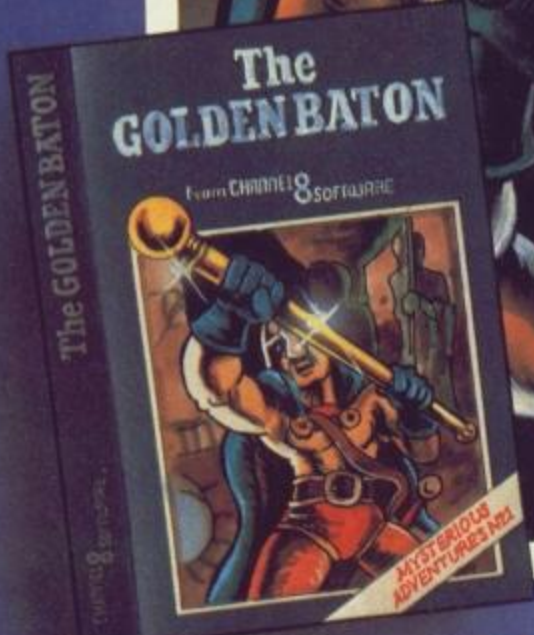

- *100% ULTRA FAST MACHINE CODE
- *SAVE GAME FEATURE
- *OPTIONAL COLOUR ZONE DISPLAY

From CHANNEL 8 SOFTWARE

THE GOLDEN BATON
 ARROW OF DEATH Pt 1
 ARROW OF DEATH Pt 2
 ESCAPE FROM PULSAR 7
 FEASIBILITY EXPERIMENT
 THE TIME MACHINE
 CIRCUS

**From Channel 8
 Software Limited
 51 Fishergate,
 Preston. PR1 8BH.**
 Trade enquires welcome

To: Channel 8 Software Limited, 51 Fishergate, Preston, Lancashire. PR1 8BH.
 Please supply me with the following 16K Atari Games

.....

NAME.....
 ADDRESS.....

I enclose £..... (£17.99 per Game)
 Cheques should be made payable to Channel 8 Software Limited. Cheque Postal Order Access Barclaycard
 If you wish to pay by Credit card please enter your account number below:

.....

26 GAMES

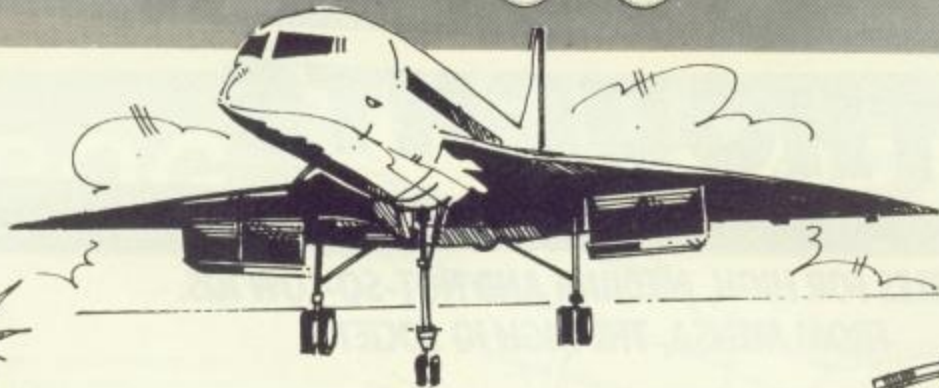

The figures on the arrivals/ departures board at Outer Thisworld Airport represent the exact mileages of Concorde, based at the airport, from the relevant destinations.

Our jet has a problem regarding its staying power.

It can only travel 1,000 miles on a full tank.

Can you work out the different combinations of cities Concorde could visit... using every drop of its fuel each time? And remember, due to customs restrictions in Outer Thisworld, Concorde must return to base after visiting one city and before leaving for the next during each 1,000 mile trip.

Answer on page 112.

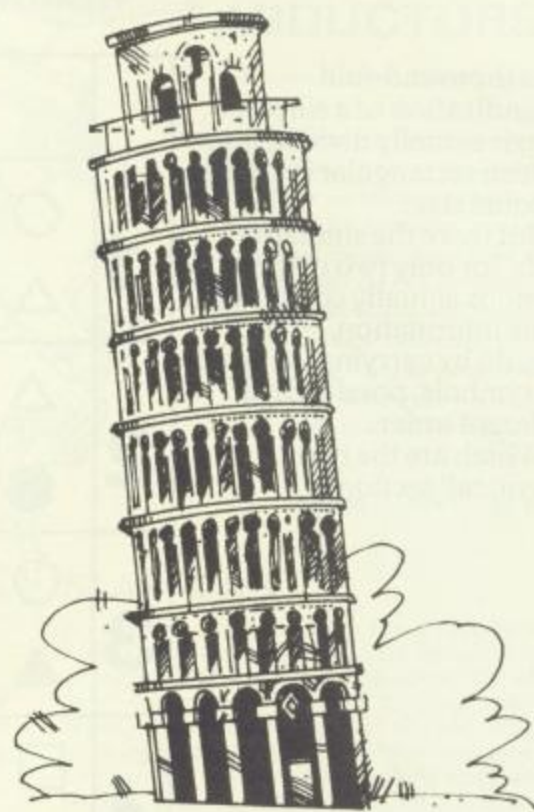

FLIGHT INFORMATION

CAIRO	700
PARIS	376
NEW YORK	150
LONDON	188
SYDNEY	624
ATHENS	168
PISA	586
ROME	150

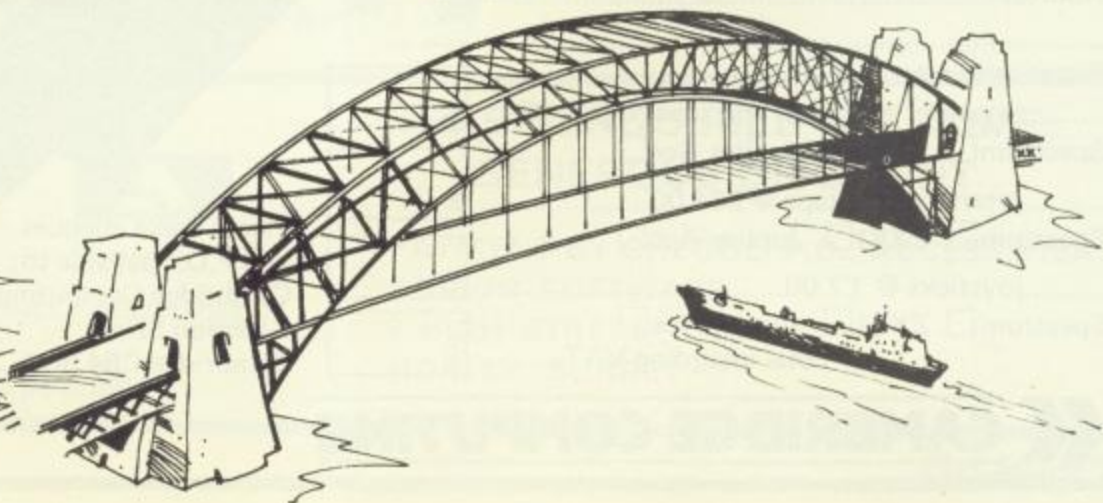
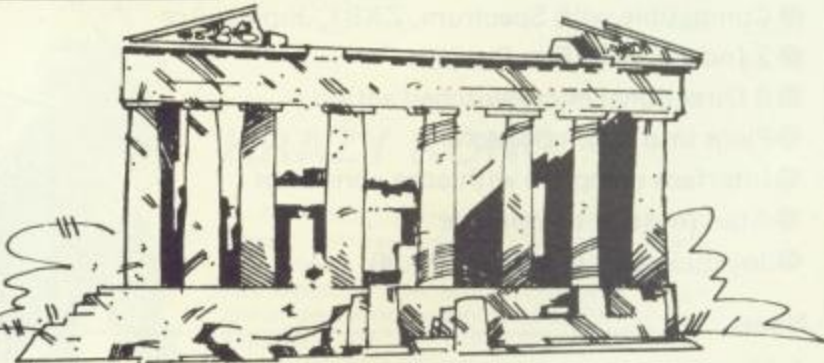

THOUGHTS

PUZZLES FOR HIGH, MEDIUM AND NOT-SO-LOW IQS.
FROM MENSA, THE HIGH IQ SOCIETY.

This thousand-fold magnification of a silicon chip is actually divided into sixteen rectangular sections of equal size.

But there the similarity ends, for only two of those sections actually convey the same information – which they do by carrying the same six symbols, possibly in a different order.

Which are the two 'identical' sections?

	A	B	C	D
1	○ □ △ △ △ ○	● □ ● △ □ ●	○ ○ ▲ ▲ ○ ▲	□ ○ △ △ □ ○
2	△ ○ △ ● △ △	■ ○ △ ○ ○ ■	○ ● ■ △ □ ▲	■ □ ■ ○ △ ■
3	○ ▲ ▲ ▲ ○ ●	○ □ △ ○ □ ○	■ △ ■ △ ○ ■	□ ▲ □ ▲ □ ●
4	□ ● △ ● △ □	■ ○ ○ ■ □ ○	▲ ● ▲ ▲ □ □	▲ □ △ ○ ● ■

Answer on page 112

At last! A joystick that works!

Cambridge Computing bring you the first intelligent joystick.

Works on all existing software - regardless of which keys the program uses. No need for specially written software. Features include:

- Compatible with Spectrum, ZX81, Jupiter Ace
- 2 Independent Fire Buttons
- 8 Directional Microswitched action
- Plugs into edge connector
- Interface complete with edge connector
- Atari joystick compatible
- Joystick with Interface £29.90

Enquiries from dealers are welcome, ring Chris Lloyd on 0223-522905

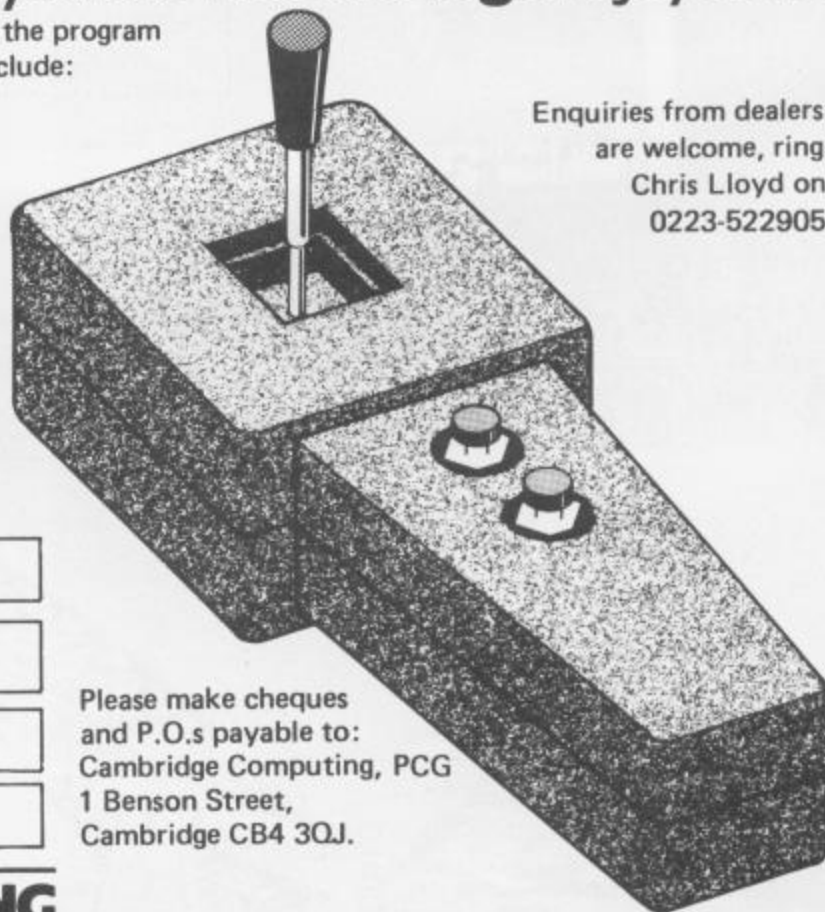

Please make cheques and P.O.s payable to: Cambridge Computing, PCG 1 Benson Street, Cambridge CB4 3QJ.

Name.....
Address.....

Please send me:

.....joystick, interface, and tape @ £29.90.... £

Spectrum ZX81 Jupiter Ace

.....interface and tape @ £24.00..... £

Spectrum ZX81 Jupiter Ace

.....joysticks @ £7.00..... £

Spectrum ZX81 Jupiter Ace

Total including VAT..... £

CAMBRIDGE COMPUTING

ANIROG

SOFTWARE



XENO II

An E-XPANDED-D screen presentation with superb action packed space thriller written entirely in machine code with four action packed stages. To destroy the power source of Xeno II you have to fight off waves of robot attack, plasma bombing by the legions of the outer sanctum and finally attack the power source protected by a force field, continuous bombardment by guardians and blockading by wild whirling suicidal space ships. Truly a game for all arcadians.

JS VIC 20 16K £7.90

CAVERN FIGHTER

All M/C version of SCRAMBLE

KB/JS VIC 20 Unexp. £5.95

TINY TOT'S SEVEN

Super games pack for younger children with bright colour graphics and sound effects. Everybody's favourite Simon plus Super Snap, O's and X's, Word Jumble, Bomber, Duck Shoot and Mad Drivers.

KB SPECTRUM 16K/48K £4.95
KB VIC 20 Unexp. £5.95

PHARAOH'S TOMB

Once you enter, the only way out is with the aid of a key which unlocks the mystery of the Pharaoh's tomb. Beware of the mantraps the ancient Egyptians so painstakingly built. One false move and you will meet the same fate as befell other tomb robbers over thousands of years. A multi-screen big graphical adventure with M/C movements.

KB VIC 20 16K £5.95

ZOK'S KINGDOM

Your starcruiser badly damaged in a meteor storm is forced to crash land on the planet ruled by ZOK, a time space generated image of Dracula. You are challenged to a battle of wits and endurance as the battle for survival starts in earnest in this big multi-screen graphical adventure in hi-res graphics and M/C movements.

KB/JS VIC 20 16K £5.95

MINI-KONG

For UNEXP from the writer of Krazy Kong comes the equally brilliant Mini-Kong. You will wonder how he managed to cram so much in the unexpanded VIC. Brilliant multi-colour graphics, expanded screen, lift, rolling barrels, ladders, running score/Hi-score and not to forget the hand bar bonus in this all M/C presentation.

K.B./J.S. VIC 20 UNEXP £5.95

FROGRUN

Popular arcade game. All machine code with brilliant colour graphics and sound effect. Features include snakes, crocodiles, lady frogs, turtles, cars, lorries and logs.

KB/JS VIC 20 Unexp. £5.95
KB/JS SPECTRUM 16K/48K £4.95
KB/JS COMMODORE 64 £5.95

DOTMAN

Ghosts chase you as you try to eat the dots and collect points. You can turn the tables on them by eating the pills. Don't forget the ghosts have been given intelligence and will try to corner you. This feature makes Dotman exciting and challenging. All M/C game complete with running and highest scores and tunnels.

JS/KB VIC 20 Unexp. £5.95



JS VIC 20 16K £7.90

GALACTIC ABDUCTORS

A stunning action packed game which uses all of your TV screen for the superb large animated graphics. Giant Space Hawks whirl and weave in intricate patterns as they drop their deadly homing mines which will destroy your base on contact. While you are busy defending yourself, the Hawks will feed on your helpless population returning only their skulls. All M/C game complete with high score table that will blow your mind with its graphics and sound effects.

SLAP DAB

An exciting game based on the arcade game PAINTER which combines fast action with strategy. Giant insects hiding under the old paint surface are released by your paint brush. You require fast action and quick thinking to outwit them and finish the panel. The game is 100 percent machine code and HI-RES. graphics also includes HI-score and running score with brilliant sound effects.

KB/JS VIC 20 UNEXP £5.95

CRAWLER

All M/C version of Centipede

JS VIC 20 Unexp. £5.95

3D TIME TREK

At last a 3D game for the VIC! Although badly wounded you are determined to seek and destroy the marauding space pirates who have now dispersed around the galaxy in search of fresh prey. A brilliant Startrek game with a difference — spectacular 3D graphics and real arcade actions.

JS VIC 20 16K £5.95
JS COMMODORE 64 £5.95

KRAZY KONG

An E-XPANDE-D screen, large graphics, rolling barrels, hammer, fireballs, lifts, handbags and umbrellas as you try to rescue the damsel Kong has abducted. Spectacular collapse of Kong's lair in the fourth screen. Uses all 21K of your expanded Vic for this 100% M/C thriller. Complete with high score table.

KB/JS VIC 20 16K £7.90



24 HR. CREDIT CARD SALES HORLEY (02934) 6083

Overseas 50p post & packaging

TRADE ENQUIRIES WELCOME,
GENEROUS DISCOUNT

PAYMENT BY CHEQUE, P.O., ACCESS/VISA
ANIROG SOFTWARE
8 HIGH STREET
HORLEY, SURREY

THOUGHTS

The computer print-out below contains some sort of logical reasoning as to the positioning of the various symbols.

Without the correct, vital missing piece the computer malfunctions and orders you 20 King Prawn Balls from the local takeaway instead of booking two weeks for you and your mother in the Seychelles.

No doubt some would be more than tempted to insert the wrong piece and get a liking for Chinese food in great quantities, but can you work out which piece logically fits into the gap anyway?

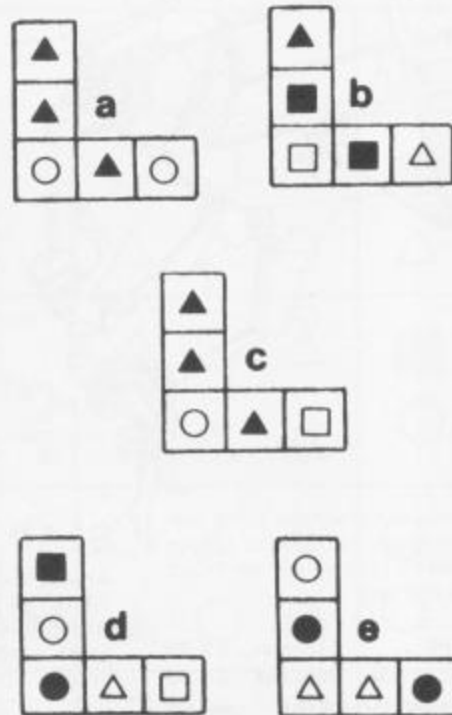

○	■	■	○	○	○	□	○	○	■	■	△
□	■	▲	○	□	○	□	○	○	■	▲	△
△	●		○	□	○	□	▲	○	■	▲	△
●	●		○	□	○	□	▲	○	■	▲	△
■	●				○	□	▲	○	■	▲	△
▲	△	○	▲	□	○	□	▲	□	■	▲	△
○	△	○	▲	△	▲	△	▲	□	●	▲	△
○	△	○	▲	△	▲	△	▲	□	●	▲	△
□	□	□	■	△	▲	△	■	□	●	○	□
□	□	□	■	△	▲	△	■	□	●	○	□
△	□	□	■	△	▲	△	■	□	●	○	□
△	○	□	■	●	■	△	■	□	●	○	□
●	○	△	●	●	■	●	■	△	●	○	□
●	○	△	●	●	■	●	■	△	△	○	□
■	▲	△	●	●	■	●	●	△	△	○	□
■	▲	△	●	●	■	●	●	△	△	○	□

Answer on page 112.

The Cheapest Rampacks In The World

AVAILABLE NOW

ZX SPECTRUM 32K RAMPACK £39.95

Simply plugs into user port at rear of computer and increases your 16K Computer instantly to 48K

- Fully Compatible with all accessories
- No need to open computer and invalidate guarantee
- Why send your computer away and wait weeks for upgrade
- Fully cased, tested and guaranteed

ZX81 16K RAMPACK £19.75 ZX81 64K RAMPACK £44.75

All Units: Fully Cased and Guaranteed. Secured No Wobble Design. Fully Compatible with all accessories.

SWEET TALKER

This amazing plug in unit for the 16K and 48K will allow you to easily create synthesised speech. Any word in the English Dictionary (and beyond) is available to you. No more lonely nights. A companion for just £34.95

ZX SPECTRUM 56 WAY CONNECTOR £2.25

PRICES INCLUDE VAT and P&P. Delivery normally 14 days. Export orders at no extra cost.

Send cheque/PO Payable to:-

CHEETAH Marketing Ltd.

359 THE STRAND LONDON WC2R 0HS Tel: 01-240 7939 Telex: 8954958

16K ZX 81 and 32K ZX Spectrum Ram Packs available

From larger branches of **John Menzies**

WE'VE PICKED THE BEST, FORGET THE REST! SPECTRUM/ZX81 SOFTWARE SUPERMARKET

All we do at Software Supermarket is play every Spectrum/ZX81 program we can find, pick out the very best and offer only those to our customers - in our ads and our catalogues.

From over 30 countries you write, praising our free selection service (it's impartial, too: we produce no programs ourselves). You say we save you plenty - in postage and mistakes.

And we're quick. *We usually send your order out on the same day we get it.* Faulty tapes, if any, replaced at once.

OUR NEW CATALOGUE IS OUT NOW. Here's a few - the best of the new, the all-time greats. Free catalogue with every order. You've got a great computer: we've got the great programs.

Mail order only, please. If we had to run a shop, we wouldn't have time to run all the programs.

48K SPECTRUM ONLY

TRANSYLVANIAN TOWER *"Enthralling and addictive" (PCW). An excellent game at a reasonable price" (PCN).* Stunning 3D graphic adventure. Fight (and shoot) your way through the 500 3D rooms in Count Creepie's castle. Combines adventure and arcade games with great skill. We can't give it up! (R. Shepherd) £6.50.

TEST MATCH *"Amazing 3D animated graphics. Watch 'em bowl, hear and see them bat, watch the fielders run!"* Choose your own teams, or use the England/Australian teams in the computer. Clear on-screen instructions. And ONE DAY CRICKET on the 'B' side, too. (CRL) £5.95.

BLACK CRYSTAL *"An excellent graphics adventure" (S. User).* The massive 180K of program, 'loads' from 2 cassettes in 6 chapters. You must solve each of the 6 stages to defeat the Lords of Chaos. Real-time monster battles, 16 command keys. Instruction manual, (Carnell) £7.50.

THE HOBBIT *"Takes first place for quality and value for money" (S. User) "A marvellous game...should set the standard" (ZX Comp).* Free 285 p illustrated book contains clues to help you. 30 beautiful full-screen pictures; 500 word vocabulary; 16 page instruction manual: it took 4 people 18 months to write! (Melbourne House) £14.95

RESCUE *"Excellent...the best adventure game I have ever played" (PCN)* 20 page clearly written on-screen manual leads you to very ingenious 3 stage adventure. Four skill levels. Full information on screen plus a map when you need it! Great fun. (CRL) £5.95.

TRADER *"Great fun...much more entertaining than the usual adventure" (Your Computer).* Great spaceships, pretty maps, animated graphics - a big adventure that loads in 3 parts. *"Outstanding" (P.C.T.).* (Quicksilver) £9.95

PIMANIA *"Amusing and brilliant...the graphics are excellent" (S. User).* A wonderfully witty adventure, great graphics and music and you could win the £6,000 Golden Sundial of Pi. (Automata) £10.00

ANY SPECTRUM

LET 'E.T.X.' TALK TO YOU *The clearest speech we've ever heard in this "adventure/graphic arcade game utilizing every byte of computing power in the Spectrum" (Abbex).* Enchanting graphic adventure: 16 landscapes: 1400 power zones: 4-levels: 16-page on-screen manual: up to 9 players: it's amazing what a Spectrum can do. E.T.X. will run in 16K, but without speech. Use keyboard or Kempston/AGF joystick. (Abbex) £5.95.

FROGGY *The best frog there is, we reckon. This game uses so much memory, you even have to unplug your printer. Loads in 2 parts. As you get better, the game gets harder. Just great. (DJL) £5.95*

JUNGLE FEVER *Escape down the pigmy death-run. Smashing full-screen animated graphics as you leap raging waterfalls, swing on a rope across deep pits, dodge spiders and poisoned blow darts. Good sound, too. On-screen lives, score, hi-score with name, time left. Some of the best graphics we've seen. (A&F) £6.90.*

MONSTERS IN HELL *Can you dig fast enough to escape from the Mad Monk's monsters? Vampires, followed by ghouls, clones, demons and more chase you successively up and down above the very realistic flames of Hell. Very exciting game. (Softtek) £5.95.*

JET-PAC *Absolutely brilliant graphics from a new company. Control your test pilot spaceman with his jet-pack as you build your spaceship, fuel it up and take off for a new planet. All the time avoiding the nasties and collecting treasure! Wonderful! 1 or 2 players. Keyboard or Kempston joystick. (Ultimate) £5.50*

HEATHROW *Air Traffic Control. If you've outgrown your flight simulator, get in charge at Heathrow. Land your planes safely using your radar and stack displays. Watch out for rogues. 7 skill levels, including demo. (Hewson) £7.95*

WINGED AVENGER *"Hard to beat" (CVG) "One of the best Sinclair games so far" (PCW)* Very fast 'PHOENIX', 7 play levels, 3 attack waves, laser shield: mothership with smart bombs. A best-seller. (Work Force) £4.50

3D TANX *Shoot the enemy tanks from your moving 3D turret. 3 play levels: accurate ballistics: 1 or 2 players: pause: demo game: training program: even plays God Save The Queen. (DK'tronics) £4.95*

FAUST'S FOLLY *The first adventure we've seen that's worth playing in 16K. It's great and it's graphic! Loads in 2 parts: clear instructions: then a smashing adventure with directions, inventory, look, score, save. (Abbex) £5.95*

ZX81 OWNERS

Special 16K ZX81 versions of 5 of these programs are available. Use the coupon to order. Free 12-page ZX81 only catalogue with order or phone for catalogue only.

BLACK CRYSTAL	£7.50	WINGED AVENGER	£4.50
TRADER	£9.95	FROGGY	£5.95
PIMANIA	£8.00		

CHARGE PROGRAMS TO ANY VISA CARD CALL 01-789 8546 (24 hours)

To: Software Supermarket, 87 Howard's Lane, London, SW15 6NU.

If you do not want to cut this magazine, write your order out carefully on plain paper and quote this number (PCG1)

I own a 16K Spectrum 48K Spectrum 16K ZX81 (please tick).

I enclose my Cheque/PO for £..... payable to Software Supermarket. Please use block capitals. If we can't read it, you won't get it.

Name

Address

Postcode

Phone, if any, in case we have a query

Program Name	Computer	Price
		£
		£
		£
		£
		£
		£
POSTAGE	U.K. Add 55p only per order	£0.55p
AND	EUROPE. Add 55p for each program	£
PACKING	OUTSIDE EUROPE. Add £1 for each - program airmail	£
TOTAL		£

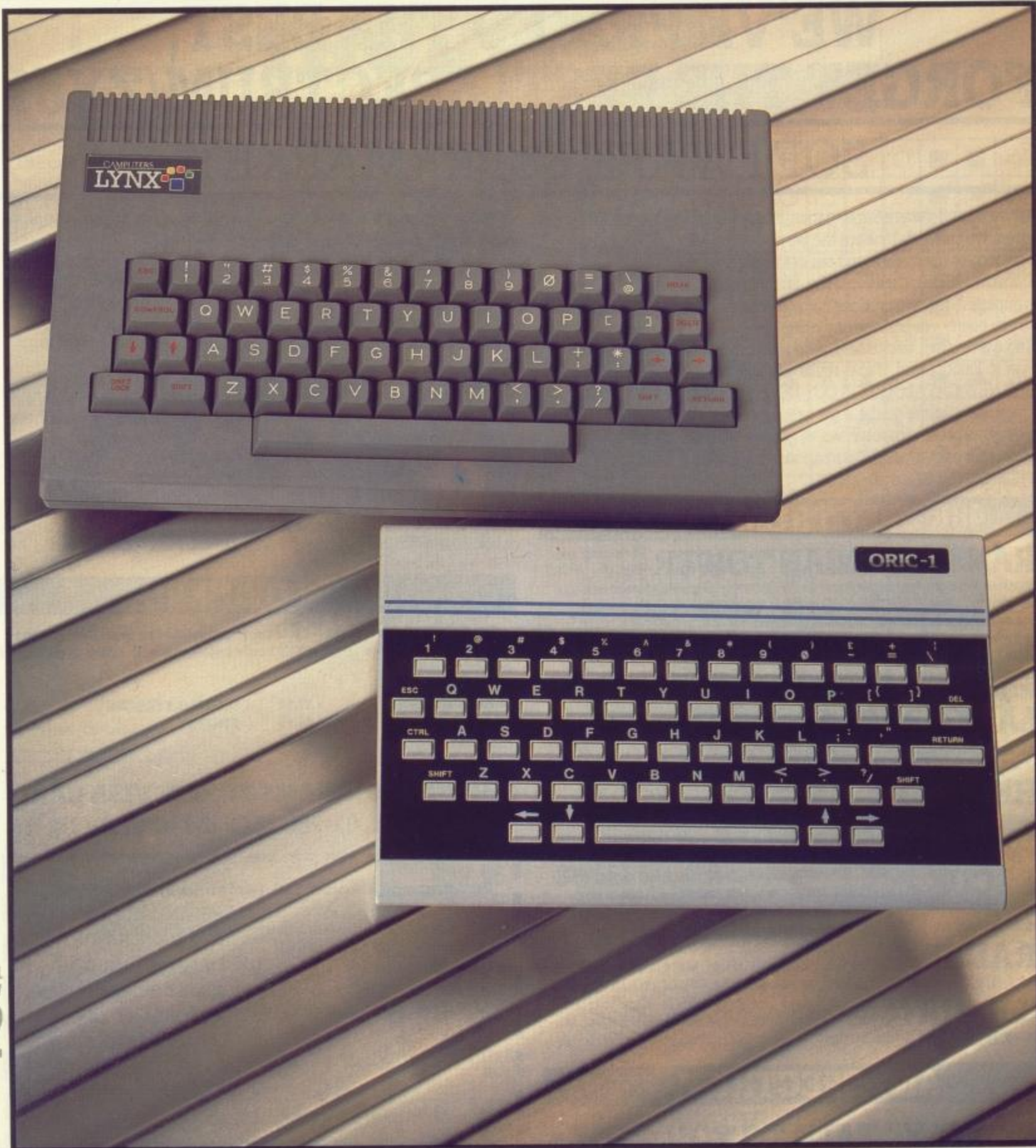

SPECIAL
REVIEW
32

MAKING MICROWAVES

The appearance of the Oric-1 has demonstrated once again the almost comical inability of British micro manufacturers to launch a new machine properly. Funded by British Car Auctions and using the considerable experience of Tangerine Computers, the Oric is aimed at the fastest-growing sector of the micro market: the sub £200 home computer.

The delivery difficulties that dogged both the BBC micro and the Sinclair Spectrum should have alerted Oric to the pitfalls ahead. But the new company observed its rivals' mistakes, then promptly repeated them.

As a result of this short-sightedness, reviews have already appeared in some magazines that will have dissuaded a large number of prospective purchasers from buying. These reviews have contained wrong information and have failed to mention any of the Oric's strong points. This is no reflection on the journalists involved — there is no way they could have done a proper job with the material.

A BASIC ASSET

First of all, let it be said that the Oric-1 represents extremely good value for money. It is a 16k colour and sound machine, with Centronics printer interface and RGB monitor socket fitted as standard. The price? Under £100.

I suspect that most people will go for the 48k version. At £170, it is slightly dearer than the 48k Spectrum. Indeed, it seems inevitable that the Spectrum will be Oric's main rival.

In our review machines ROM chips were not fitted; instead, there were two EPROMs. All references to 'ROM' in this review should take this into account.

Measuring 280 x 175 x 52mm, the Oric weighs in at 1.1kg. The keyboard has 57 keys, described as possessing 'tactile feedback'. They are a sort of halfway house between a full keyboard and the Spectrum 'dead flesh' keys. The keyboard is considerably less cluttered than the Spectrum's, with a maximum of two functions per key. The cursor control keys

are sensibly arranged on either side of the space bar.

On power-up, the display is in TEXT mode with the caps lock on. This is important as all keywords and variables must be entered in upper case. Any attempt to user lower case is met with '?SYNTAX ERROR'. Variable names can be of any length, but only the first two characters are recognised. Great care must be taken when choosing variable names as the Oric is fussy about what it will accept.

Despite the fact that only the first two characters are significant, reserved words anywhere in the variable title will stop execution of the program. Unfortunately, there are a lot of reserved words, and the characters that make them up occur in many descriptive names. You cannot have a variable called 'SCORE', for example, as that contains the Boolean operator OR. TO crops up in 'TOTAL'. And it is all too easy to overlook combinations including ON, AND, IF. The manual is reticent on this subject. It warns against the use of 'PIG' or 'PIPES' as they both contain PI, but then gives 'JONI' as an example. This contains the reserved word ON and thus doesn't work. This will prove irritating.

The Oric uses an extended version of Microsoft Basic. Unlike the Sinclair dialect, this does not use 'tokenised' keywords. All these have to be entered in full.

This Basic is an extremely good implementation, with features not often found on more expensive computers. As on the Spectrum, computed GOTOs and GOSUBs are supported. A line like GOTO A*100 is quite in order, assuming you have given A a value earlier in the program.

Structured programming purists will be glad to see that you can GOTO or GOSUB a label. Define COUNT as, say, 500 and you can quite happily GOSUB COUNT at any time. This makes renumbering of a program considerably easier. You simply change the initial value assigned to the subroutine, rather than going through the whole program line by line.

A word of warning to Sinclair users, however. The Oric requires you to hit

line numbers exactly. On the Spectrum you can GOTO 499 even if there is no such line; execution will continue from the next line. On the Oric this will halt the program.

Generally, the Oric Basic has more to recommend it than Sinclair's version. Other commands supported by Oric, but not by the Spectrum, include REPEAT ... UNTIL, DEEK and DOKE, CALL, DEF USR, FRE, IF ... THEN ... ELSE, LOG, ON ... GOTO/ GOSUB, SPC, TRON and TROFF. There are a few more that apply to HIRES mode only and are thus not strictly comparable.

In addition to TEXT mode, there are three modes for graphics on the Oric: LORES0, LORES1 and HIRES.

For low-resolution graphics, TEXT mode can be retained. Or you can select either of the two LORES commands.

COLOUR SPLASH

Screen resolution is theoretically 28 lines of 40 characters. But in most cases the far left column cannot be used as it contains the attribute controlling the background colour for each row.

Colours can be set globally, using Sinclair-style INK and PAPER commands. They can also be set locally by POKEing or PLOTting attributes onto the screen. If colours are set globally, you should note that INK and PAPER will change the whole screen instantly, without a CLS command.

When POKEing or PLOTting on screen, take care that codes are entered at a blank area of the screen. Failure to do this will mean that any character already there is overwritten and replaced by a space. When working in LORES0, the alternate characters can be accessed by using PRINT CHR\$(9) and the standard set regained with CHR\$(8).

In HIRES mode, the screen is divided into pixels with a resolution of 240 x 200. You are not limited in the number of colours displayed, and the Oric gives more flexibility than does the Spectrum in changing colours. Each attribute will work on an area one character square in width by one

**LATEST MICROS INCLUDE A
SERIOUS RIVAL TO THE SPECTRUM
AND A HIGHLY UPGRADABLE
HOME COMPUTER. STEVE MANN
AND MAGGIE BURTON REVIEW
THE ORIC AND THE LYNX**

Access

SHARP

SOLO SOFTWARE

MZ-80K
MZ-80A

See the new range of high-quality

Adult Games

and

Adventure Series

DRAGON CAVES

A 3-dimensional trip through a maze of over 1,000 chambers. Hidden deep in Dragon Caves is the Magic Amulet stolen from you by the Dragon's slaves. This Amulet must be found and removed from the Caves together with any other treasures that you may discover. In the maze there are several creatures, some of whom you must kill and others who will help you—if they feel like it. The only exit from the Caves is patrolled by a fearsome Dragon who you must defeat to escape with the Amulet. Superb 3-D graphics and realistic monsters make this a must for all owners of Sharp machines.

Price £9.95.



TOMBS OF KARNAK

A complex game of battles and discovery through a honey-comb labyrinth. First you are allotted a character which will determine your chances in the maze of 50 tombs. Next, you must confront the Guardian of the Tombs and the Quartermaster where you can barter for the armour and weapons that you will need. Then you start your journey through the Tombs of Karnak inhabited by an assortment of lethal beings who you must avoid or kill. Gory details of all battles are displayed on the screen—not for the squeemish amongst you. Characters from this game can be saved on cassette for use in further adventures.

Price £9.95

Business Programmes

DAYBOOK

A simple and effective sales or purchase daybook system for the small company or self-employed person. Can be used for amounts including or excluding VAT. VAT calculations will either compute VAT content if included in the amount or work out the correct amount that should be added. Full print-out and data storage facilities included in this useful business system.

Price £29.95



Twin-pack Games

Five-a-Side Soccer. A computer soccer game with a difference. You control a team of five players against the computer. You can name each team at the start of the match (choose your favourite team). Players controlled by the computer will move individually and you can select to move either the whole team at once or each player separately. The first team to score ten goals wins the match.

Tracker. You need to plan your route most carefully as you track the animals in this field. You are forbidden to cross your own tracks or move outside the playing area. The speed slowly increases as time goes by PANIC!!!

Price £9.95

Don't forget—our prices are fully inclusive—NO HIDDEN EXTRAS.

Send for our extensive catalogue NOW

Solo Software
51, Broad St., Worcester WR1 3LR
Telephone (0905) 26524

pixel in depth. So you can have 200 lines of alternating colours down the screen.

The definition is generally very good, with each colour sharp and distinct. Characters can be plotted onto the high-resolution screen using CHAR. And there is provision for three lines of text to be entered at the bottom of the screen.

Drawing is simplicity itself. Move the cursor to the relevant place with CURSET followed by the pixel coordinates and what is described in the manual as an 'FB' number. 'FB' stands for foreground or background, and thus lines or points can be plotted or erased.

Relative moves are handled by CURMOV, which has the same syntax. CIRCLE draws what should be a circle but appears to be an ellipse.

Oric supports eight colours. The advertisements rather misleadingly claim 16 but this just means eight foreground and eight background.

USER'S FRIEND

There is only one level of brightness. Against this must be set the fact that the Oric is extremely flexible in dealing with text formats. Characters can be normal or double size, flashing or steady. And this is achieved with a minimum of fuss by using the CTRL key.

It is easy to define your own characters, using either the standard or the alternative character set. Characters are unusual in that they are defined on an 8 x 6 grid, with the leftmost two columns always being blank.

For anyone used to the weedy BEEPs produced by the Spectrum, the Oric's sound facilities will come as a revelation. In addition to the arcade-style, preprogrammed noises such as PING, SHOOT, ZAP and EXPLODE, the Oric has three tone channels and a noise channel. You can manipulate the latter to produce effects that are limited only by your imagination. With a range of six octaves, some impressive music can be obtained.

Sound generation is controlled by the MUSIC, SOUND and PLAY commands. The output is defined with MUSIC and SOUND and the envelope by PLAY. The envelope determines the 'shape' of the sound, so you can decide whether it starts sharply like a guitar or smoothly as on an organ. There are seven shapes which can achieve some stunning effects.

The sound commands are relatively complex but the results are well worth the time and experimentation.

Volume can be set in SOUND and MUSIC statements in the range 1 to 15. One thing you have to remember is to include a PLAY 0, 0, 0, 0 program line - otherwise the last note played will continue indefinitely.

Sound is definitely one of the Oric's strong points. It is not on a par with the BBC machine. But it could well be

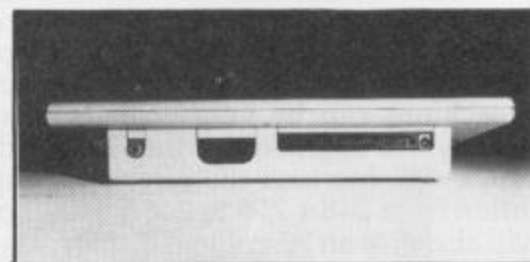
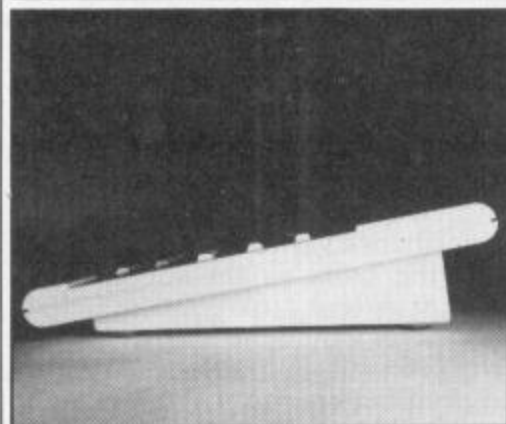

Top: the Oric-1 keyboard is less cluttered than the Spectrum. Left: space-age profile and handy tilt for typing. Above: RGB socket and Centronics interface built in.

WHAT WILL IT COST?

Oric 16k	£99.95
Oric 48k	£169.95
Oric communications modern	£79.00
Oric microdrive	not yet available

TECHNICALITIES

Processor:	6502A
RAM:	16k or 48k
ROM:	16k
Keyboard	57 key, tactile feedback ASCII, auto-repeat
Screen	domestic TV, provision for RGB colour monitor
Disk	microdrive, not yet available
Language	Basic in ROM

a deciding factor if you are hesitating between buying an Oric or a Spectrum.

To conclude, the Oric is an extremely good machine and one that represents extraordinarily good value for money. There is no doubt that it will prove to be a strong rival to the Spectrum in what is an extremely competitive sector of the market.

That said, I think the Spectrum may be a better machine for an absolute beginner. The graphics facilities are easier to handle on Sinclair's machine and the Spectrum manual, though far from perfect, is more helpful than Oric's. Sinclair's tokenised keywords are also probably easier for the beginner.

There are some glaring faults. In each of the four models I looked at, EPROMs were installed instead of ROMs and the Basic contained some annoying errors. I had assumed that these would be corrected before the machines were sent to customers. But it appears that some Orics have been sold through the Spectrum (no relation) retail chain. Presumably Oric will replace these faulty models - under the Sale of Goods Act, the customer is entitled to either a new machine or money back.

When the present bugs have been dealt with, and if Oric rewrites its manual to a higher standard, then the Oric-1 should become a best-selling success.

SM

The Lynx is enjoyable to use. It can produce impressive visual effects easily and has a good range of useful, if slow, functions. It also has lots of potential: as a good home computer, as a CAL machine or as a small business micro.

If you bought one now, you would find you could have a lot of fun with it. But the Lynx has had production problems. First, the machine itself was late. There is little software as yet. And there are no definite dates for other hardware to come. Its popularity will depend on how fast manufacturer Computers can produce these, and on the Lynx offerings from the various software houses.

The machine reviewed here is the standard 48k model. 92k, 128k and 192k versions are available and smaller machines can be fully upgraded internally. An upgrade to either 128k or 192k will increase the screen resolution from 248 x 256 to 248 x 512. It will also give an 80-column display.

The actual measurements of the machine are 34.5cm wide, 21.5cm from front to back and 6.5cm at the highest point.

When you first switch on, the Lynx prints its logo, complete with a little pawprint, at the top left of the screen. Under this comes the prompt 'Ready!' and a 'greater than' sign followed by a flashing block cursor.



The Lynx: a proper keyboard

The display is quick to appear and very crisp. Initial tuning is very simple and, once set, it rarely drifts off frequency. The only problem is that the display is rather too sensitive to the position of the TV leads. Jerking this or loosening it slightly – as can happen when the TV gets knocked – can cause the screen to waver. The colours are very vivid and crisp and they don't drift when the machine is tuned. Full upper and lower case lettering is provided directly from the keyboard.

Performance varies from TV to TV. I found the Lynx would not produce colour at all on a nine-year-old Ferguson (neither would the Spectrum), but it worked well with a Sony Trinitron and even better with a small Hitachi portable. If in any doubt, do consult your dealer.

The Lynx provides eight colours, including black and white. These are coded from 0, which is black, to 7,

which is white. You can use the colour's name as well as its number. I found that this improved program readability.

PROTECT is a command which gives some interesting visual effects. The Lynx sends colour signals as a mixture of three colours: red, blue and green. If you type PROTECT RED, everything in red already on the screen cannot be cleared or overprinted. But any new characters or lines with an element of red in their colours will have the red removed.

You can also protect subcolours like magenta or cyan, which means you can print on the screen in only one colour. PROTECT 0 (black) returns you to a three-colour mix again. Protecting white will stop anything from being written on, or erased from, the screen.

It can be unnerving if you forget that anything already on the screen in the protected colour cannot be moved. It looks as if the computer has crashed (hard crash, I mean) if you have listed a program and then run it with a PROTECT statement before a CLS statement.

Colour mixing is possible using a find chequered graphics character (CHR\$(242)) as it is on the Spectrum. You can do this only in squares, but the crispness of colour makes it very striking.

You can also define your own char-

BALL BY BALL

Test Match Simulation for 48K Spectrum

"Ball by Ball" is based upon our original "TEST-MATCH" program still available for the ZX81.

"Ball by Ball" will simulate either an entire test series or a one day limited over series. The simulation is very realistic as users of our ZX81 version will already know.

This program is for serious students of the game of cricket. There are no little men running around the screen. You pick the teams and grade the strengths and weaknesses of each player. Progress of the game is seen through the comprehensive scoreboard plus an accompanying ball by ball narrative.

Acting as captain of both sides you can intervene with new instructions to your teams at any time.

Our promise: If you like cricket you will never get bored with this program.

Features:

- Real time electronic scoreboard.
- Ball by ball comments.
- Full scoreboard of current match.
- Bowling averages for series.
- Batting averages for series.
- One day match option.
- Changes in weather allowed for.
- Action controlled by you as captain.
- Save game in progress.
- Hard copy option for record purposes.

Cassette includes two copies of program plus audio commentary plus demonstration match in progress.

'Ball by Ball' for 48K Spectrum £5
'TEST-MATCH' for 16K ZX81 £4

Incl. VAT, Packing & Postage.

VIDEO
SOFTWARE LIMITED

Stone Lane, Kinver,
Stourbridge,
West Midlands
Tel: 038-483 2462

PANCOM

...for the best of Atari 400-800 software

Zaxxon 16Kd/32Kc	26.50	Starcross 32Kd	27.95
Dig Dug ROM	24.75	Snooper Troops II 48Kd	27.50
Donkey Kong ROM	33.95	Legionaire 40Kd	24.95
Miner 2049 ROM	28.45	Voyager 32Kd	16.95
Airstrike 16Kc/24Kd	13.95	Moon Patrol 16Kc	16.95
Preppie II c/d	23.75	Shootout & OK Galaxy 16Kc	13.75
Choplifter 48Kd/16K Rom	24.50/27.95	Quix ROM	24.75
Earthquake 1906 16Kc	16.95	Conflict 2500 32Kc	10.50
Repton 48Kd	27.50	Andromeda (New Improved) 32Kd	20.75
Shamus Case II 16K c/d/ROM	23.50/28.50	Demon Attack 16K ROM	27.50
Spitfire Ace 32Kc/40Kd	24.50	Dog Daze 8Kc	15.50
Wingman 32Kc/40Kd	24.50	Eastern Front 1941 16Kc	20.45
Mountain King 16K ROM	27.95	Protector 32Kc	22.95
Boulders & Bombs 16K ROM	27.95	Sneakers 32Kd	20.75
Moon Shuttle 16Kc/32Kd	26.50	Jeepers Creepers 32Kd	18.95
A.C.E. 4Kc	7.50	Encounter & Questar IV 24Kc	15.95
Stones of Sisyphus 40Kd	23.95	Starbase Hyperion 32Kc/32Kd	16.95/18.95
Necromancer 32K c/d 16K ROM	23.50/28.50	Andromeda Conquest 16Kc	12.50
Shaft Raider 24Kc/32Kd	18.75	Alien Garden 16K ROM	27.95
Sprite Maker 64 c	6.95	Stellar Shuttle 16Kc/24Kd	20.50
Superfront c	6.95	Mission Asteroid 40Kd	20.75
Super Skramble c	9.95	Mouskattack 40Kd	20.75
Pinball 32Kc/32Kd	23.75	Dr Goodcodes Cavern 48Kd	20.50
A.E. 48Kd	24.50	Sky Blazer 32Kd	21.95
Survivor 16K c/d	24.95	Ultima II 48Kd	42.65
Fort Apocalypse 32K c/d 16K ROM	23.50/28.50	Lunar Lander 32Kd/24Kc	14.25/10.25
Gorf 16K ROM	28.50	Planet Miners 24Kc	10.95
Black Hole c	5.50	Buried Bucks 16Kc/24Kd	20.95
Hellcat Ace 32K c/d	24.95	Star Sentry 24Kc/32Kd	20.95
Claim Jumper 16K c/d 16K ROM	23.50/28.50	Jumpman 48K c/d	28.50
Xenon Raider 32Kc/32Kd	13.95	Pharaohs Curse 32K c/d 16K ROM	23.50/28.50
Baja Buggies 16Kc/24Kd	20.75	Speedway Blast 16K ROM	28.50

More than 400 titles available. Send 50p for lists. Extensive stocks Atari VCS titles at best prices. All items 60p postage etc extra.
PANCOM, 6 TRANBY DRIVE, GRIMSBY, SOUTH HUMBS.
Tel: (0472) 694196 Mon to Fri 9am-5.30pm; Sat 9am-12pm.

DRAGON 32



THE RING OF DARKNESS

The game created to be the most complete, enthralling, addictive and detailed adventure ever written for the Dragon 32. A whole graphic world (of nearly 3000 travel days) with kings, princesses, mad jesters and dangerous quests will unfold before you. Across ocean, river, mountain and forest you travel to trade in many towns and dare the depths of vast dungeons (more than 9 levels deep with over 20 different creatures in hi-res 3-D graphics), in search of fortune and the hidden curse of the Dark Ring. Many hours of mystery, suspense and raw excitement await you.

"The most impressive adventure tested ... soon displaced breakfast TV in our house." Your Computer (April)

DRAGON TREK

Your starship has just entered quadrant 6-8. You are surrounded by 8 battle cruisers of the Klingon Empire. Do you fight or run? They launch a salvo of photon torpedoes. You're HIT! Get a damage report. It's OK, the shields are holding, the next move is up to you, but be quick or they will attack again. Hi-res graphics, onboard computer and lag time interaction will have you zapping Klingons till the stardate 2477.

"Excellent value for money." Your Computer

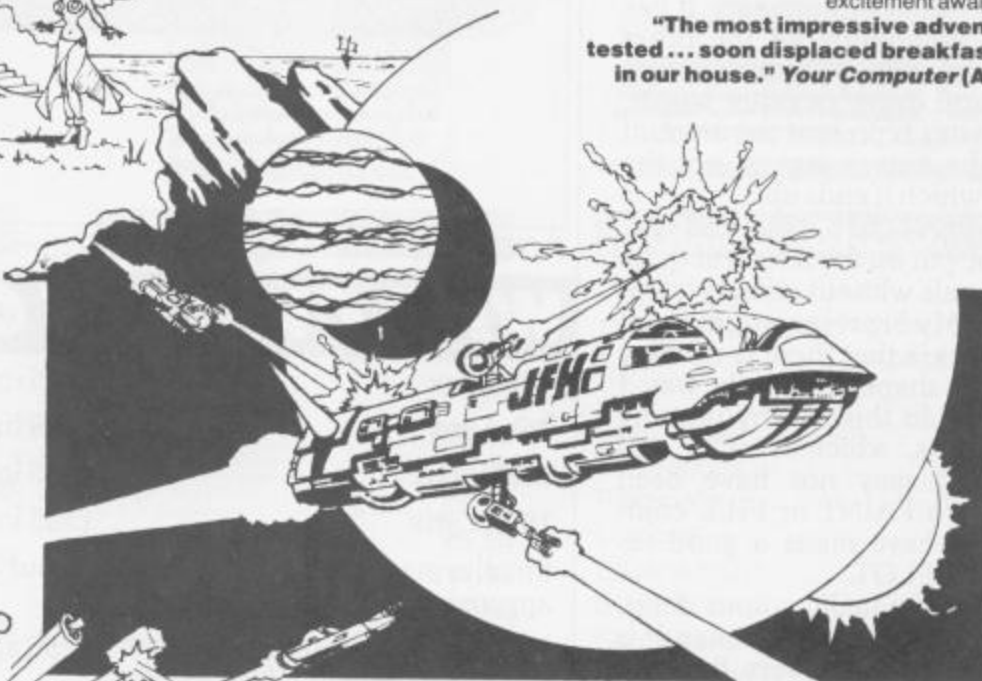

PEPPER'S GAME PACK

Huge blue mushrooms, mad wizards, bouncing bricks, chessboard strategy, doomed space shuttles and mind-teasing codes. They're all to be found on this great compendium of six games (Mushroom Muncher, Nad the Necromancer, Pepper's Breakout, Chessboard Tracker, Chameleon Run and MasterBrain).

ARTIST'S DESIGNER

Produce intricate designs in hi-res graphics and save them on cassette. Full list of features include text merging, joystick or keyboard control, circles, paint and shape replication. Ideal for home video captions, education, charts and diagrams.

All prices include p&p, VAT and the WINTERSOFT guarantee of quality and reliability.

Available from Boots and good Software outlets

Post coupon now to:

WINTERSOFT
Dept G, 30 Uplands Park Road, Enfield,
Middx. EN2 7PT

Please rush me copies of (tick box)

- | | | |
|--------------------------|---------------------------|--------|
| <input type="checkbox"/> | The Ring of Darkness..... | £10.00 |
| <input type="checkbox"/> | Dragon Trek..... | £6.99 |
| <input type="checkbox"/> | Pepper's Game Pack..... | £7.95 |
| <input type="checkbox"/> | Artist's Designer..... | £6.99 |

I enclose cheque/PO for: £.....

Name.....

Address.....

WINTERSOFT

SOFTWARE

Dealer enquiries welcome

Tel: 01-3675 5720

acters. The Lynx character matrix is 6 x 10, which is unusual. It leads to rather elongated lettering but is not unattractive.

The Lynx's screen resolution – 256 x 248 – allows some impressive drawing effects. DOT, DRAW, MOVE and PLOT are the relevant commands. DOT puts a dot on the screen at the specified coordinates. DRAW puts a line on the screen from the last point plotted, or the last position of the graphic cursor, to the point specified. MOVE simply moves the invisible graphic cursor to where you tell it to go. PLOT is rather unnecessary: it has five modes combining all the other graphic commands along with a relative move and draw. In other words, the coordinates represent the amount by which the cursor moves, not the position at which it ends up.

Line drawing is crisp, clear and fast. Lines can be put on the screen at quite steep diagonals without an ugly 'stepping' effect. My big reservation about Lynx graphics is that there is no easy way to fill a shape. The only way I could find to do this was by plotting individual dots, which is slow and inaccurate. It may not have been possible, but a PAINT or FILL command would have made a good replacement for PLOT.

Pixels are individually colour definable. When the DOT command is used, they prove to be very fine and clear in any colour.

OPEN WINDOW

One interesting idea is the use of PRINT@ and WINDOW. Both use columns two pixels wide. PRINT@ uses rows to the highest resolution of 248 to put letters exactly where you want them on the screen. So you can mix text and graphics tidily. WINDOW specifies the size of the text area. You specify the first and the last column +1, and the first and last row +1, to change the part of the screen on which you want to print.

Some fascinating things can be achieved here by using WINDOW in conjunction with PROTECT. Again, I have one reservation: a quick normalising command would have been handy to reset the window to its default. As it is, you have to remember the coordinates of the normal text window and use those numbers to put things back to normal.

The VDU is another Lynx oddity. This uses CHR\$(ASCII) codes 0 to 31 to perform cursor movements and other graphics commands. It is also used for the power-up beeping noise. You can use PRINT CHR\$ to do the same thing, so the VDU is rather unnecessary. It is, however, quicker to enter than PRINT CHR\$.

Three of the facilities here are really striking. The first is VDU 12 – overwrite. This is like the Spectrum's OVER command and is turned off by inputting VDU 20. Secondly, there's

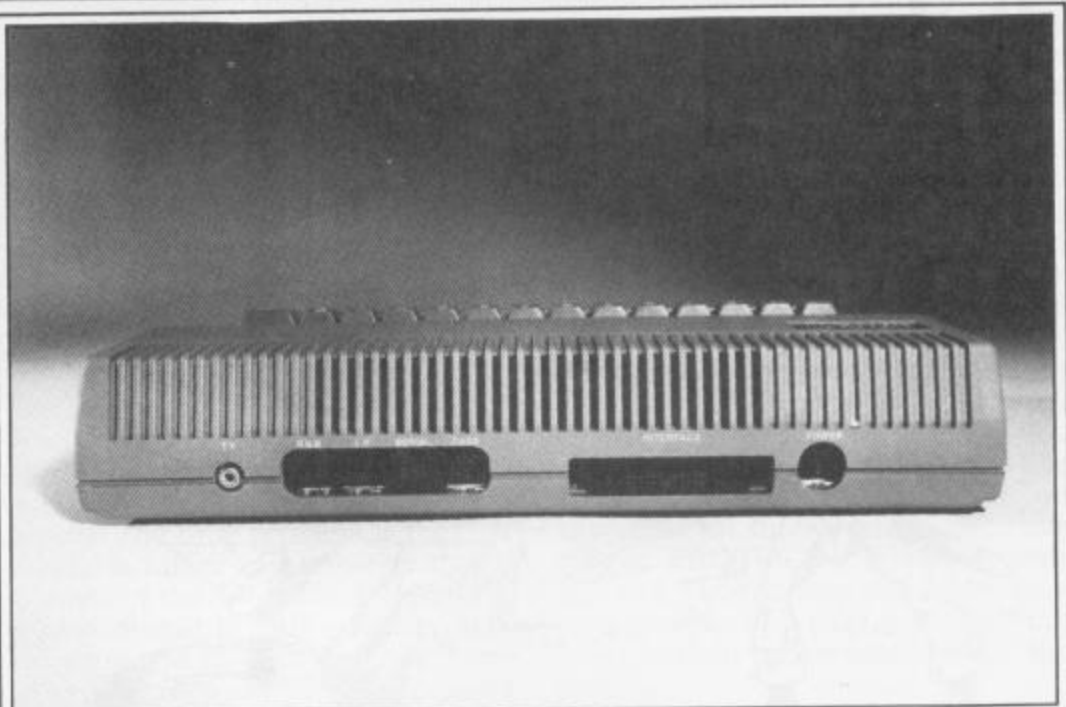

RGB, composite video, RS232 – all come as standard

WHAT WILL IT COST?

48k Lynx	£225 inc VAT
96k Lynx	£299 inc VAT
128k Lynx	£345 inc VAT
192k Lynx	£395 inc VAT

Smaller machine upgrades will work out at approximately the same overall price.

Computers single disks	£250 approx
Computers twin disks	£400 approx
RS232 lead	not available
Printer	£60 approx
Light pen	not yet available
CP/M	not yet available

TECHNICALITIES

CPU:	4 MHz Z80A
RAM:	48k (16k graphics, 16k user) expandable to 192k total
ROM:	16k
I/O ports:	expansion bus, cassette, RS232, RGB, composite video
Disks:	single or twin, SS/DD, 250k/drive
Languages:	Basic; Pascal and Forth to come

VDU 24 – double-height characters (turned off by VDU 25). You can obtain striking effects by mixing single- and double-height text. Lastly, and more subtly, you can employ superscript and subscript on text. This simply means moving the cursor up or down to give an overlapping effect.

The other VDU codes are for such things as carriage return, colour change, line feeds and backspace. I'll make a huge criticism here: the screen does not scroll.

Sound is based on a digital/analogue conversion principle and is used with two commands: BEEP and SOUND.

BEEP is followed by three figures broken up by commas. They stand for

wavelength, number of cycles and volume. Volume is specifiable from 0 to 63, and wavelength and number of cycles from 0 to 65535. The wide parameters make for an impressive range of sounds.

SOUND is a machine code-based command. You can POKE several consecutive addresses with appropriate values, type in SOUND and the first of these addresses. The computer will read them and convert the values to sounds, stopping when it reaches a value of 0. This could conceivably be used to synthesise speech.

You can incorporate machine code into Basic programs by prefixing each line with CODE. INP and OUT read

GAMES



ATARI

ATARI 400 (16K Basic) ... £145.00
 ATARI 800 (48K Basic) ... £289.00

Package Deals –

(1) 400 (16K) + Basic + Manuals
 + Recorder + Joysticks + 5
 blank cassettes + Demo/
 Games £199.00
 (2) 400 (48K) + all above
 items £284.00
 (3) 800 (48K) + all above
 items £339.00
 (4) 800 (48K + Basic + Manuals
 + Disk Drive + Joystick + 3 blank
 disks + Demo Disk £574.00
 Latest Programs –
 Necromancer (C/D) £24.95
 Fort Apocalypse (C/D) £24.95
 Pharaoh's Curse (C/D) £24.95
 Preppie II (C) £24.49
 Time Warp (C/D) £14.95
 Escape from Perilous
 (C/D) £14.95
 Miner 2049er (ROM) £29.95
 Zaxxon (C/D) £27.50

SORD M5

Sord M5 £189.95
 Graphic Basic £34.95
 Basic F £34.95
 FALC £34.95

All prices include VAT



SPECTRUM

Spectrum (16K) £99.95
 Spectrum (48K) £129.95
 ZX Printer £39.95

Software –

Knot in 3D £5.95
 3D Tunnel £5.95
 ETX £5.95
 All Diddums £5.50
 The Hobbit £14.95
 Superchess (16K) £6.99
 Superchess (48K) £7.95
 + 100's more Programs

DRAGON 32

Dragon 32 £169.00

Software –

Space Race £7.95
 Hi-Res Cartridge £25.30
 Dream Assembler £10.95
 Bonka £8.95
 Chess £7.99
 Droids £7.99
 Dragon Mountain £4.95
 Star Jammer £7.95

Oric I £169.00
 ZX81 £39.95
 Ace £89.00
 Sharp MZ80A £499.00
 Epson HX-20 £462.00
 Epson QX-10 £1995.00



COMMODORE 64

Commodore 64.... } Call
 1541 Disk Drive... } for new
 } low price

Programs –

Centropods £5.99
 Pakacuda £5.99
 Cyclons £5.99
 Escape MCP £5.99
 Superfont £6.95
 Spritemaker £6.95
 Motormania £8.95

VIC 20

Vic Pack (inc. Vic/Recorder/Intro
 to Basic/4 Games) £139.95

TV GAMES

Latest Atari cartridges –

Spider Fighter, River Raid,
 Megamania £26.95 each
 Donkey Kong, Wizard of Wor,
 Gorf, Carnival, Centipede £24.95
 each
 Jedi Arena, Action Force,
 Reactor £27.99 each

Latest Intellivision cartridges –

Nova Blast, Ice Trek, Dracula,
 Tropical Trouble £25.95 each
 Vectron, Solar Sailor £29.95 each

COMING SOON –

COLECO + VECTREX TV
 GAMES

24 Gloucester Road, Brighton
Tel: Brighton 698424

or send data from/to specified Z80 parts.

A machine code monitor can be accessed from Basic by typing MON; it is exited by typing 'J'. This includes a breakpoint facility as a debugging aid.

On the subject of Lynx Basic, I've got no choice but to express stern reservations. Some of the effects which can be obtained with ease are really striking, but the overall structure is not in keeping with the reasoning behind it. At first sight it looks fantastic from a programming view, but using it for a while reveals serious disadvantages.

David Jansons, who designed Lynx Basic, has had a lot of experience of Microsoft and TRS-80 Basic. 'I don't like them,' he said. His aim in putting together a highly non-standard Basic was to make it 'as structured as possible'. Considering he put the original interpreter together in little over four months, it's quite an achievement. But it has been regularly amended since the machine was announced in September.

It includes some very odd qualities indeed, the reasoning behind which seems a little strange. First and foremost, it won't allow multi-statement lines. The next oddity lies in the number of loops and conditionals provided. Unusual facilities include, most notably, the ability to change the cursor character and the rate at which it flashes.

Debugging is made easier not only by

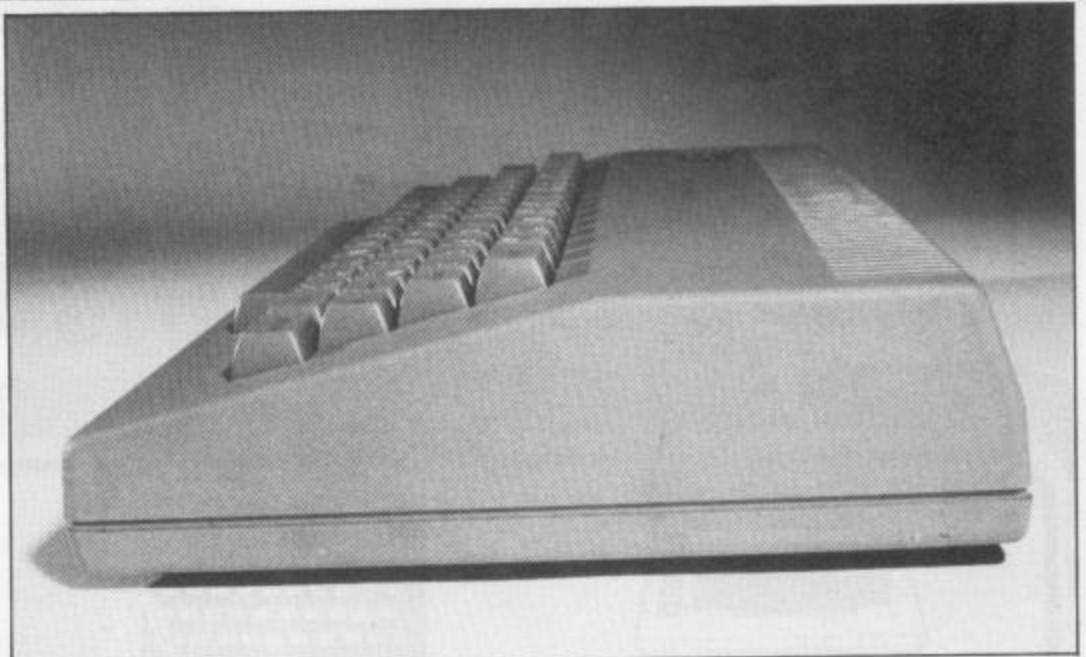

The Lynx's casing is neat and stylish

a flow trace but also by a command SPEED. The latter sets the rate of program execution, so you can slow down the program lines to see exactly what's going on. Editing is fairly simple.

Lynx Basic has several omissions which appear to have been replaced by unnecessary trimmings. It repeats itself and thus leaves out more important things. The lack of a reset key makes it possible to get into a terminal crash very easily - for instance, if you get stuck in an input loop you cannot use ESCape to get out of it and you

have to switch the machine off. A little thought here would have made all the difference.

Computers has made dealer agreements with Spectrum Computer Centres and with Lasky's. No plans for more dealers are in the air as Computers does not want stock-flow problems. It plans to have produced 40,000 Lynxes by the end of this year.

A 12-month warranty is tacked onto the package, but this excludes labour. Servicing after that will be carried out by subcontractors and by 'one of the retailers'.

MB

Mr. Chip

SOFTWARE

SPECIAL
REVIEW
40

VIC 20 GAMES AND UTILITIES

SKI-Sunday - Guide your skier down the forested course, through the slalom gates, avoiding the many hazards, but watch out for the ice.

POLARIS - You are in command of a nuclear sub, destroy as many enemy ships and planes with your missiles, in 90 seconds.

Both these games are in multi-colour, with many sound effects and tunes £5.50

JACKPOT - Own your own fruit machine, just like the real thing, with nudge, hold and re-spin, can you win the jackpot? You will be amazed by the graphics, colour's and many sound effects, with nine different tunes, a full machine code program, a very compulsive game..... £5.50

MINI-ROULETTE - PONTOON - HI-LOW

Three great games of chance for the VIC, try to beat the computer, hours of fun, full colour, sound effects and tunes..... £5.50

DATABASE - create your own files and records on tape..... £7.50

BANK MANAGER - Computerise your bank account..... £5.00

SUPER BANK MANAGER - A full feature version any memory size, but needs 3K expansion..... £7.50

M/C SOFT - Machine code Monitor and Disassembler, any memory size..... £7.50

COMMODORE 64 GAMES AND UTILITIES

LUNAR RESCUE - Our own version of that popular arcade game..... £7.50

PONTOON - ROULETTE - ACE'S HIGH
More powerful versions, that make three great games of chance for the 64..... £7.50

M/C SOFT 64 - Assembler and Disassembler, with decimal to hex converter, everything our program for the VIC will do and more..... £7.50

BANK MANAGER 64 - As our Super Bank Manager, but for the 64..... £7.00

Full documentation with all utility programs.

Other software available for the VIC and Commodore 64, send for free brochure, including **RABBIT SOFTWARE** for the VIC, at our Special Offer of £7.50 each or buy two or more at £7.00.

Send Cheques/PO's to: **MR. CHIP SOFTWARE**

Dept PCG, 1 NEVILLE PLACE, LLANDUDNO, GWYNEDD, LL30 3BL. Tel: 0492 49747

WANTED: HOT SHOT SOFTWARE WRITER'S, PHONE AND ASK US, ABOUT OUR FAIR DEAL POLICY AND TOP ROYALTIES.

DEALER ENQUIRES WELCOME

WINDOW ON ANOTHER WORLD



Cruise through the deepest reaches of space in a life and death struggle to decide the fate of the galaxy. Match wits with mighty mages in the final battle for supremacy of the planet Xarg. Test your driving skills on the tracks at Monte Carlo and Monza. Or just relax on a Sunday afternoon with a round or two at your local golf course.

Salamander Software offers a wide range of games for the Dragon 32, ORIC, BBC Model B and Tandy 32K microcomputers. Whatever your age, whatever your taste, Salamander Software has the program for you!

**"Why can't all software
come up to this standard?"**
— Computer and Video Games

DRAGON 32 and TANDY 32K:

Dragon Trek £9.95.
Wizard War £7.95.
Golf £7.95. Grand Prix £7.95.
Vulcan Noughts and Crosses £7.95.
Games Compendium D1 £7.95.
Star Jammer £7.95.
Super Skill Hangman £7.95.
Nightflight £7.95.
The Salamander Graphics System £9.95.
Franklins Tomb £9.95.
Everest £7.95.
Grid Runner £7.95.

BBC MODEL B:

Dragon Rider £7.95.
Tanks! £7.95.
Games Compendium B1 £6.95.
Games Compendium B3 £6.95.
EDG Graphics Package £24.95.

ORIC-1

Oric Trek £9.95.
Oric Games Compendium £7.95.

Cheques or postal orders payable to:
SALAMANDER SOFTWARE, Dept. C,
27 Ditchling Rise, Brighton, East Sussex BN1 4QL.
Tel: 0273 771942
Send SAE for a full Catalogue

Salamander Software



GREAT NEW SOFTWARE DEAL

Buy 'n Try - the sensible way to shop for software. Simply buy any item from our software range. Try it out at home. If it's not exactly what you expected, then we'll buy it back for a full 80% of the price you paid against another purchase of equivalent or greater catalogue value any time within 1 month of purchase.

Which means you can keep right up to date with the latest software and games releases without making costly mistakes.

How it Works

Example: Buy a game for £10. If it's not as good as you thought, then we'll buy it back for £8 against your choice of another game worth £10 or more. Just send us the difference. There's just one simple rule we can only agree to buy back software that's in working order.

Look at our super selection and complete the order form to take advantage of the hottest software deal ever, or telephone your order to Software Centre on 01-487-5974, quoting your Access/Barclaycard number (24-hour telephone service).

B.B.C. MICRO

	Mem	Reg'd	Supplier	Code No	Price
Space Pirates	16K		Bug Byte	02B001	£8.00
Space Warp	32K		Buy Byte	02B002	£9.00
Golf	32K		Bug Byte	02B003	£5.50
Dragon Quest 1	16K		Bug Byte	02B004	£11.50
Fruit Machine	B		Bug Byte	03B006	£5.50
B.B.C. Airlift	B		Bug Byte	02B007	£5.50
Polaris	32K		Bug Byte	02B008	£5.50
B.B.C. Chess	32K		Bug Byte	02B009	£8.00
B.B.C. Backgammon	A/B		Bug Byte	02B010	£8.00
B.B.C. Multitile	16K		Buy Byte	02B011	£15.00
B.B.C. Micro Derby	A/B		Bug Byte	02B012	£5.50
Swoop B/A	32K		Micropower	24B029	£7.99
Alien Destroyers	32K		Micropower	24B030	£7.99
Galactic Commander	32K		Micropower	24B031	£7.99
Timetrek	32K		Micropower	24B032	£7.99
Laser Command B/A	32K		Micropower	24B033	£7.99
Astro Navigator B/A	32K		Micropower	24B034	£5.70
Chess B/A	32K		Micropower	24B035	£7.99
Footer B/A	32K		Micropower	24B036	£7.99
Adventure			Micropower	24B037	£7.99
Cowboy Shootout	32K		Micropower	24B038	£6.85
Munchyman			Micropower	24B039	£6.85
Seek			Micropower	24B040	£6.85
Eldorado Gold B/A	32K		Micropower	24B041	£6.85
Roulette B/A	32K		Micropower	24B042	£5.70
Reversi 2 B/A	32K		Micropower	24B043	£5.70
Filer			Micropower	24B044	£10.30
Micro Budget			Micropower	24B045	£7.99
Constellation B/A	32K		Micropower	24B046	£6.85
Disassembler			Micropower	24B047	£6.85
World Geography	32K		Micropower	24B048	£6.85
Where B/A	32K		Micropower	24B049	£6.85
Junior Maths Pack	32K		Micropower	24B050	£6.85
Star Trek/Candyfloss	A or B		I.J.K. Software	33B001	£6.50
6 Games	A or B		I.J.K. Software	33B002	£4.50
Mutant Inv/Breakout	A or B		I.J.K. Software	33B003	£6.50
Beep Beeb B or A	32K		I.J.K. Software	33B004	£4.50
Beebmunch B or A	32K		I.J.K. Software	33B005	£6.50
Super Hangman B or A	32K		I.J.K. Software	33B006	£4.50
3D Maze B or A	32K		I.J.K. Software	33B007	£4.50
Invaders A			I.J.K. Software	33B008	£5.50
Invaders B or A	32K		I.J.K. Software	33B009	£7.50
Wordpro B or A	32K		I.J.K. Software	33B010	£10.50
Atlantis/Scramble	32K		I.J.K. Software	33B011	£7.50
Flags	32K		I.J.K. Software	33B012	£4.50
Hyperdrive	32K		I.J.K. Software	33B013	£6.50
Strato Bomber	32K		I.J.K. Software	33B014	£7.50
Creative Graphics	A/B		Acornsoft	53B051	£9.95
Arcadians	B		Acornsoft	53B052	£9.95
Sliding Block Puzzles	B		Acornsoft	53B053	£9.95
Snapper	B		Acornsoft	53B054	£9.95
Desk Diary	A/B		Acornsoft	53B055	£9.95
Cube Master	B		Acornsoft	53B056	£9.95
Tree of Knowledge	B		Acornsoft	53B057	£9.95
Lisp	A/B		Acornsoft	53B058	£16.85
City Defence			Bug Byte	02B059	£7.50
Space Invaders			Bug Byte	02B060	£7.50
Galaxy Wars			Buy Byte	02B061	£7.50
Asteroid Belt			Comp. Concept	60B073	£7.80
Space Hawks			Comp. Concept	60B074	£7.80
Golden Baton			Digit. Fantasia	61B075	£10.30
Time Machine			Digit. Fantasia	61B076	£10.30
Arrow Death 1			Digit. Fantasia	61B077	£10.30
Arrow Death 2			Digit. Fantasia	61B078	£10.30
Pulsar 7	32K		Digit. Fantasia	61B079	£10.30
Circus	32K		Digit. Fantasia	61B080	£10.30
Feasibility Experiment			Digit. Fantasia	61B081	£10.30
Frogger			I.J.K.	33B088	£7.50
Croaker			Micropower	24B108	£7.99
Dragon Rider			Salamander	62B109	£7.95

B.B.C. MICRO cont.

	Mem	Reg'd	Supplier	Code No	Price
Tanks			Salamander	62B110	£24.95
Compenices & Statements			Gemini	63B115	£19.95
Home Accounts & Budget			Gemini	63B116	£19.95
Decision Maker			Gemini	63B117	£5.95
Stock Control System			Gemini	63B118	£19.95
Selective Mailing List			Gemini	63B119	£19.95
Commercial Accounting			Gemini	63B120	£19.95
BBC Word Processing	32K A or B		Gemini	63B121	£19.95
Beebcalc			Gemini	63B122	£19.95
Moonraider B/A	32K		Micropower	NEW	£7.99
Galactic Commander B/A	32K		Micropower	NEW	£7.99
Spacemaze B/A	32K		Micropower	NEW	£6.85
Maze Invaders B/A	32K		Micropower	NEW	£5.70
Star Trek A or B			Micropower	NEW	£5.70
Killer Gorilla B/A	32K		Micropower	NEW	£7.99
Croaker B/A	32K		Micropower	NEW	£7.99
Barrage B/A	32K		Micropower	NEW	£7.99
Labyrinths of LaCoshe B/A	32K		Micropower	NEW	£7.99
Painter B/A	32K		Micropower	NEW	£6.85
Caveman Adventure	A or B		Micropower	NEW	£6.85
Yahtzee B/A	32K		Micropower	NEW	£5.70
Wall B/A	32K		Micropower	NEW	£5.70
Mastermind	A or B		Micropower	NEW	£4.55
Music Processor B/A	32K		Quicksilver	NEW	£14.95
Algebraic Manipulation B/A	32K		Acornsoft	NEW	£9.95
Arcade Action B/A	32K		Acornsoft	NEW	£11.65
Cube Master B/A	32K		Acornsoft	NEW	£9.95
Forth B/A	32K		Acornsoft	NEW	£16.85
Word Hunt B/A	32K		Acornsoft	NEW	£11.90
Sphinx Adventure B/A	32K		Acornsoft	NEW	£9.95
Peeko Computer B/A	32K		Acornsoft	NEW	£9.95
Rocket Raid B/A	32K		Acornsoft	NEW	£9.95
Meteors B/A	32K		Acornsoft	NEW	£9.95
Missing Signs B/A	32K		Acornsoft	NEW	£11.90
Number Balance B/A	32K		Acornsoft	NEW	£11.90
Sentence Sequencing B/A	32K		Acornsoft	NEW	£11.90
Planetoid B/A	32K		Acornsoft	NEW	£9.95
Super Invaders B/A	32K		Acornsoft	NEW	£9.95
Painting B/A	32K		BBC Soft	NEW	£10.00
Fun Games B/A	32K		BBC Soft	NEW	£10.00
Music B/A	32K		BBC Soft	NEW	£10.00
Beebmon	A or B		Micropower	NEW	£10.30
Draw	A or B		Micropower	NEW	£10.30
Chemistry	A or B		Micropower	NEW	£6.85
World Geography	A or B		Micropower	NEW	£5.95
Physics	A or B		Micropower	NEW	£6.85

COMMODORE 64

Monopole	Rabbit	13K002	£9.99
Grave Robbers	Rabbit	13K003	£9.99
Sprite Editor/Graphic Generator	Rabbit	13K004	£9.99
Adventure Pack 1	Rabbit	13K005	£9.99
Attack on Mutant Camels	Llamosoft	52K006	£8.50
Rox 64	Llamosoft	52K007	£4.95
Gridrunner	Llamosoft	52K008	£8.50
Colonels House	Rabbit	13K009	£9.99
Grand Master Chess	Audiogenic	16K012	£17.95
Renaissance	Audiogenic	16K013	£8.95
Motor Mania	Audiogenic	16K014	£8.95
Super Skramble	Terminal	NEW	£9.95
Star Trek	Interceptor	NEW	£7.00
Panic 64	Interceptor	NEW	£7.00
Frogger 64	Interceptor	NEW	£7.00
Centropods	Rabbit	NEW	£5.99
Pakacuda	Rabbit	NEW	£5.99
Escape MCP	Rabbit	NEW	£5.99
Cyclons	Rabbit	NEW	£5.99
Lunar Lander	Channel 8	NEW	£9.95
Superfont	English Soft	NEW	£6.95
Spritemaker	English Soft	NEW	£6.95
Vixplode - 64	Albraso	NEW	£8.50

NB. Software Centre is not a software library.

SINCLAIR ZX81 cont.

Mem Req'd	Supplier	Code No	Price
	ICL	27E016	£3.95
	ICL	27E017	£3.95
	ICL	27E018	£3.95
	ICL	27E019	£3.95
	ICL	27E120	£3.95
	ICL	27E121	£3.95
	Psion	28E122	£4.75
	Psion	28E123	£4.75
	ICL	27E124	£4.95
	ICL	27E125	£4.95
	ICL	27E125	£4.95
	ICL	27E127	£4.95
	ICL	27E128	£4.95
	ICL	27E129	£4.95
	ICL	27E130	£20.95
	ICL	27E131	£4.95
	Psion	28E132	£5.95
	Psion	28E133	£5.95
	ICL	27E134	£6.95
	ICL	27E135	£6.95
	ICL	27E136	£6.95
	ICL	27E137	£6.95
	ICL	27E138	£6.95
	ICL	27E139	£6.95
	ICL	27E140	£6.95
	ICL	27E141	£6.95
	Psion	28E142	£6.95
	Sinclair	20E143	£6.95
	Sinclair	20E144	£7.95
	Sinclair	20E145	£7.95
	Sinclair	20E146	£9.95
	Sinclair	20E147	£9.95
	Quicksilva	12E148	£3.95
16K	Quicksilva	12E149	£3.95
16K	Quicksilva	12E150	£3.95
16K	Quicksilva	12E151	£3.95
16K	Bug Byte	02E175	£10.00
16K	Bug Byte	02E176	£4.00
	Bug Byte	02E177	£8.00
	Bug Byte	02E178	£5.00
	Bug Byte	02E179	£6.00
	Bug Byte	02E180	£6.50
	Bug Byte	02E181	£6.50
	Bug Byte	02E182	£9.00
	Bug Byte	02E183	£5.00
	Bug Byte	02E184	£8.00
16K	Bug Byte	02E185	£17.50
	Sinclair	20E186	£6.95
	Sinclair	20E187	£4.75
	Sinclair	20E188	£4.75
	Sinclair	20E189	£4.95
	Sinclair	20E190	£4.95
	Sinclair	20E191	£4.95
	Sinclair	20E192	£4.95
	J K Greye	32E001	£3.95
1K	J K Greye	32E002	£3.95
1K	J K Greye	32E003	£4.95
16K	J K Greye	32E004	£4.95
16K	J K Greye	32E005	£4.95
16K	Addictive	50E193	£5.95
16K	Artic	25E194	£3.95
16K	Artic	25E195	£3.95
16K	Artic	25E196	£6.50
16K	Artic	25E197	£3.95
16K	Artic	25E198	£9.95
16K	Artic	25E199	£9.95
1K	Artic	25E200	£2.95
	Artic	25E201	£9.95
	Artic	25E206	£3.95
1K	Artic	25E207	£6.00
	Artic	25E208	£6.50
	Artic	25E209	£5.95
	Artic	25E210	£14.95
	Artic	25E211	£7.00
	Bug Byte	02E212	£5.00
	Bug Byte	02E213	£4.00
	Bug Byte	02E214	£8.00
	Bug Byte	02E215	£10.00
	Hewson	70E216	£5.95
	Hewson	70E217	£5.95
	Microgen	06E218	£3.95
	Microgen	06E219	£3.95
	Microgen	06E220	£3.95
	Microgen	06E221	£3.95
	Microgen	06E222	£3.95
	Microgen	06E223	£3.95
1K	Microgen	06E224	£3.95
	Microgen	06E225	£3.95
	Quicksilva	12E226	£3.95
	Quicksilva	12E227	£3.95
	Quicksilva	12E228	£3.95
	Quicksilva	12E229	£9.95
	Quicksilva	12E230	£3.95
	Quicksilva	12E231	£9.99
	Gemini	63E232	£7.95
	Gemini	63E233	£5.95
	Gem Software	NEW	£4.95
	Gem Software	NEW	£4.95

BUY 'N TRY MEANS 80% OFF YOUR SECOND PURCHASE

*** Personal callers welcome come along see our super selection!**

VIC 20

Mem Req'd	Supplier	Code No	Price
	Adda	01V001	£38.95
	Adda	01V002	£28.95
	Adda	01V003	£28.95
16K	A.S.K.	14V004	£8.95
16K	A.S.K.	14V005	£8.95
8K	A.S.K.	14V006	£8.95
16K	A.S.K.	14V007	£8.95
3K	Rabbit	13V008	£9.99
	Rabbit	13V010	£6.99
	A.S.K.	14V012	£8.95
	A.S.K.	14V013	£8.95
	Rabbit	13V014	£4.99
3K	Rabbit	13V015	£4.99
16K	Rabbit	13V016	£19.99
16K	Rabbit	13V019	£14.99
8K	Navajo	19V020	£12.95
	Creative	19V021	£14.95
	Creative	19V022	£14.95
	Creative	19V023	£14.95
	Creative	19V024	£14.95
	Creative	19V025	£14.95
	Audiogenic	16V026	£24.95
	Audiogenic	16V027	£19.95
8K	Audiogenic	16V028	£7.95
16K	Audiogenic	16V029	£12.95
	Audiogenic	16V030	£19.95
3K	Audiogenic	16V031	£7.95
	Audiogenic	16V032	£19.95
	Audiogenic	16V033	£14.95
8K	Audiogenic	16V034	£19.95
	Audiogenic	16V035	£19.95
	Audiogenic	16V036	£6.95
	Audiogenic	16V037	£6.95
	Audiogenic	16V038	£8.95
	Audiogenic	16V039	£7.95
	Audiogenic	16V040	£6.95
3K	Audiogenic	16V041	£6.95
3K	Audiogenic	16V042	£7.95
3K	Audiogenic	16V043	£8.95
	Audiogenic	16V044	£7.95
	Audiogenic	16V045	£7.95
	Audiogenic	16V046	£8.95
	Audiogenic	16V047	£7.95
	Audiogenic	16V048	£7.95
3 or 8K	Audiogenic	16V049	£7.95
	Audiogenic	16V050	£7.95
	Audiogenic	16V051	£19.95
	Audiogenic	16V052	£19.95
	Audiogenic	16V053	£19.95
	Audiogenic	16V054	£19.95
	Audiogenic	16V055	£19.95
3K	Audiogenic	16V056	£4.95
	Audiogenic	16V057	£48.95
	Imagine	05V149	£5.50
	Imagine	05V150	£5.50
	Imagine	05V151	£5.50
16K	Audiogenic	16V058	£8.95
	Imagine	05V059	£5.50
	Romik	10V072	£9.99
	Romik	10V073	£9.99
	Romik	10V074	£9.99
	Romik	10V075	£9.99
	Romik	10V076	£9.99
	Romik	10V077	£9.99
16K	Bug Byte	02V078	£7.00
	Bug Byte	02V079	£7.00
	Bug Byte	02V080	£7.00
	Bug Byte	02V081	£7.00
	Bug Byte	02V082	£7.00
	Bug Byte	02V083	£7.00
	Bug Byte	02V084	£7.00
	Commodore	04V103	£4.99
	Commodore	04V104	£4.99
	Commodore	04V105	£4.99
	Commodore	04V106	£4.99
16K	Commodore	04V107	£19.95
8K	Commodore	04V108	£19.95
8K	Commodore	04V109	£19.95
8K	Commodore	04V110	£9.99
8K	Commodore	04V111	£9.99
8K	Commodore	04V112	£9.99
8K	Commodore	04V113	£9.99
8K	Commodore	04V114	£9.99
8K	Commodore	04V115	£9.99
3K	Commodore	04V116	£4.99
3K	Commodore	04V117	£4.99
3K	Commodore	04V118	£4.99
8K	Commodore	04V119	£9.99
8K	Commodore	04V120	£9.99
	Know your own I.Q.		

CALLING DEALERS

If you want a bit of the action and a share of the success ... call us right away.

COPYRIGHT WARNING: ALL LISTED PROGRAMS ARE PROTECTED BY COPYRIGHT

VIC 20 cont.

	Mem Req'd	Supplier	Code No	Price
Know your child's I.Q.	8K	Commodore	04V121	£9.99
Know your own personality	8K	Commodore	04V122	£9.99
Robert Carrier Menu Planner	8K	Commodore	04V123	£9.99
Vic Money Manager	8K	Commodore	04V124	£9.99
Vic Road User & Highway Code	8K	Commodore	04V125	£9.99
B.B.C. Mastermind	8K	Commodore	04V126	£9.99
Type & Tune		Commodore	04V135	£4.99
Programmers Aid Cart.		Commodore	04V136	£34.95
Machine Code Monitor Cartridge		Commodore	04V138	£34.95
Missile Panic		Titan	22V141	£6.00
Road Runner		Titan	22V142	£5.00
Android Attack		Titan	22V143	£5.00
Space Hopper		Titan	22V144	£5.00
Star Wars 2		Titan	22V145	£5.00
Mawai Attack		Titan	22V146	£5.00
Space Wars/Battle Zone		Titan	22V147	£5.00
Space Fortress		Romik	10V135	£9.99
Space Attack		Romik	10V136	£9.99
Innovative 1		Melbourne H	65V149	£5.95
Innovative 2		Melbourne H	65V150	£5.95
Innovative 3		Melbourne H	65V151	£5.95
Wizard & Princess		Melbourne H	65V152	£5.95
Tornado		Quicksilva	12V153	£5.95
Harvester		Quicksilva	12V154	£7.95
Pixel Power		Quicksilva	12V155	£7.95
Trader		Quicksilva	12V156	£14.95
Subspace Striker		Quicksilva	12V157	7.95
Starquest		Quicksilva	12V158	£7.95
Moons of Jupiter		Romik	10V159	£9.99
Grand Master Chess	8K	Audiogenic	16V160	£17.95
Choplifter (cart)		Audiogenic	16V161	£24.95
Apple Panic (cart)		Audiogenic	16V162	£24.95
Serpentine (cart)		Audiogenic	16V163	£24.95
Mangrove		Audiogenic	16V164	£7.95
Country Garden	8K	Audiogenic	16V165	£7.95
Kaktus	8K	Audiogenic	16V166	£7.95
Rabbit Call		Rabbit	13V167	£19.99
Abductor		Llamosoft	52V168	£6.00
Blitzkrieg		Llamosoft	52V169	£4.95
Gridrunner		Llamosoft	52V170	£6.00
Andres Attack		Llamosoft	52V171	£8.00
Database Management System		Gemini	63V172	£19.50
Invoices & Statements		Gemini	63V173	£19.95
Home Accounts & Budget		Gemini	63V174	£19.95
Decision Maker		Gemini	63V175	£5.95
Stock Control System		Gemini	63V176	£19.95
Selective Mailing List		Gemini	63V177	£19.95
Commercial Accounting		Gemini	63V178	£19.95
Critters		Rabbit	NEW	£5.99
Anti Matter Splatter		Rabbit	NEW	£5.99
Skramble		Rabbit	NEW	£5.99
English Invaders		Rabbit	NEW	£5.99
Pakacuda		Rabbit	NEW	£5.99
Escape MCP		Rabbit	NEW	£5.99
Cyclons		Rabbit	NEW	£5.99
The Catch		Rabbit	NEW	£5.99
Paratroopers		Rabbit	NEW	£5.99
Vixploie		Abrasco	NEW	£8.50
Android Attack		Abrasco	NEW	£9.50
Fly Snatcher		Abrasco	NEW	£7.50
Alien Hunter		Abrasco	NEW	£7.50
Double Trouble		Abrasco	NEW	£9.50
Catcha Troopa		Abrasco	NEW	£7.50
Skramble		Sumlock	NEW	£7.95
Jumpin Jack		Sumlock	NEW	£7.95
Triad		Sumlock	NEW	£7.95
Griptrap		Sumlock	NEW	£7.95
Astro Fighters		Sumlock	NEW	£6.95
Chopper		Sumlock	NEW	£6.95
Destroyer		Sumlock	NEW	£7.95
Gunfight		Sumlock	NEW	£6.95
Space Rescue		Sumlock	NEW	£6.95
Space Bomber & Man on the Run		Sumlock	NEW	£6.95
Puzzle Pack		Sumlock	NEW	£6.95
Starship Escape		Sumlock	NEW	£9.95
Data Pack		Sumlock	NEW	£8.95
Scorpion		Sumlock	NEW	£7.95
Multitron		Sumlock	NEW	£7.95
At the Circus		Sumlock	NEW	£5.95

ATARI

	Mem Req'd	Supplier	Code No	Price
Bug Off			34G052	£21.99
The Eliminator	32K	Adventure Intl	34G053	£17.99
Preppie	16K	Adventure Intl	34G054	£21.99
Sea Dragon	16K	Adventure Intl	34G055	£25.49
Stratos	16K	Adventure Intl	34G056	£25.49
Tutti Frutti	16K	Adventure Intl	34G057	£17.99
Temple of Asphai	32K	Automated Simuls	35G058	£29.75
Upper Reaches of Asphai	32K	Automated Simuls	35G059	£14.75
Invasion Orion	24K	Automated Simuls	35G060	£18.50
Hellfire Warrior	32K	Automated Simuls	35G061	£29.75
The Keys of Acheron	32K	Automated Simuls	35G062	£14.75
Danger in Drindisti	32K	Automated Simuls	35G064	£14.75
Datestones of Ryn	32K	Automated Simuls	35G065	£14.75
Rescue at Rigel	32K	Automated Simuls	35G067	£22.00
Star Warrior	32K	Automated Simuls	35G068	£29.75
Crush, Crumble & Chomp	32K	Automated Simuls	35G069	£22.00
Ricochet	16K	Automated Simuls	35G070	£14.75
Monster Maze		Automated Simuls	35G072	£29.75
Platter Mania		Automated Simul	35G073	£29.75
Alien Garden		Automated Simuls	35G074	£29.75
Action Quest	16K	J V Software	36G075	£22.00
Ghost Encounters	16K	J V Software	36G076	£22.00
Journey to the Planets	32K	J V Software	36G077	£22.00
Gorf	16K	Roklan Corp.	37G078*	£33.25
Wizard of Wor	16K	Roklan Corp.	37G079*	£33.25
Battle of Shiloh	48K	Strategic Simuls	38G080	£31.00
Tigers in the Snow	40K	Strategic Simuls	38G081	£31.00
Firebird	4K	Gebelli Software	39G082*	£29.50
Embargo	8K	Gebelli Software	39G083*	£33.00
Guardian of the Gorn	32K	In-Home Software	40G084	£22.00
Sentinel 1	24K	In-Home Software	40G085	£22.00
Pool 400	16K	Innovative Design	41G086*	£29.50
Choplifter	16K	Broderbund	42G087*	£29.95
Stellar Shuttle	32K	Broderbund	42G088	£23.55
Moon Shuttle	16K	Datasoft Inc.	43G089	£31.40
Zaxxon	16K	Datasoft Inc.	43G090	£31.40
Astro Chase	32K	First Star Software	44G091	£22.00
Venus Voyager	16K	English Software Co.	45G092	£19.95
Baja Buggies	16K	Gamestar	46G093	£22.00
Claim Jumper	16K	Synapse Software	47G094	£27.50
Claim Jumper	16K	Synapse Software	47G095*	£29.95
Shamus	16K	Synapse Software	47G096	£27.50
Shamus	16K	Synapse Software	47G097*	£29.95
Picnic Paranoia	16K	Synapse Software	47G098	£27.50
Picnic Paranoia	16K	Synapse Software	47G099*	£29.95
Necromancer	16K	Synapse Software	47G100	£27.50
Necromancer	16K	Synapse Software	47G101*	£29.95
Survivor	16K	Synapse Software	47G102	£27.50
Survivor	16K	Synapse Software	47G103*	£29.95
Shamus II	16K	Synapse Software	47G104	£27.50
Shamus II	16K	Synapse Software	47G105*	£29.95
Stargate Courier	16K	Synco	48G106*	£27.50
Laser Ants	16K	Synco	48G107	£18.50
Laser Ants	16K	Synco	48G108*	£26.75
Astron IX	16K	Synco	48G109	£18.50

* Denotes cartridge

BUY WITH CONFIDENCE TRY AT YOUR LEISURE

When we send your software order, you'll find a return address label and a list of the buy-back prices for each item ordered.

Remember, we are pledged to buy back your software against a new purchase of equivalent or greater catalogue value, provided you purchase it from us. And you get a full month to decide whether to keep your software or benefit from the buy-back option.

Of course, if you wish to return two or more software items against the purchase of a more expensive item ... then provided that their initial purchase price does not exceed that of the new program you want ... we'll be happy to help.



SOFTWARE CENTRE 128 WIGMORE STREET LONDON W1 Tel 01-487-5974

BRANCHES: LEICESTER
30 New Walk Leicester.
Tel (0533) 532704.

ILFORD
426 Cranbrook Road,
Gants Hill, Ilford, Tel 01-554-6574.

SOUTHAMPTON
The Software Centre, 112 East Street,
Southampton, S01 1HD, Tel 0703-24703.

Please rush me the following programs, and put me on the Software Centre mailing list for program up-dates and great special purchase offers. I confirm that I shall not attempt to copy any program bought from Software Centre.

Name Code No Price

Name Code No Price

Name Code No Price

Cheque () Postal order () enclosed.

Total order value £

Please debit my Access () Barclaycard () in the sum of £ Account no.

My computer is (make) Model

Memory Peripherals

Name

Address

Post code Customer Tel. No

Signed Please allow up to 14 days for delivery. P.C.G.1

SINCLAIR OWNERS READ THIS FROM

SPECTRUM CHESS Dare you face The Turk

The original Turk was an eighteenth century automation, a life-size mechanical figure resplendent in Turkish costume and seated behind a wooden cabinet on which a chess board and pieces were placed. OCP now offer you the twentieth century equivalent of that Turk - a chess-playing computer program.

The Turk challenges you to a game of chess!

MANY OPTIONS INCLUDE:

- 6 LEVELS OF DIFFICULTY
- DEMONSTRATION MODE
- BOARD EDITOR
- GAMES PRINTOUT FACILITY
- BLITZ CHESS AGAINST THE CLOCK
- TWO PLAYER MODE
- UNFINISHED GAMES CAN BE STORED
- RECOMMENDED MOVE

FULL INSTRUCTIONS PROVIDED



MACHINE CODE...IT MAKES ALL THE DIFFERENCE...

Please order to: Oxford Computer Publishing Ltd., P.O. Box 99, Oxford

Please rush me **Chess The Turk** at £8.95 each. Spectrum only
Send cheque, postal order or ACCESS No. to above address. Or
telephone order with ACCESS No. to (0753) 888866

NAME

ADDRESS

..... POSTCODE 

PCG

DUCKWORTH PERSONAL COMPUTING

a new series
written and edited by Nick Hampshire

VIC Programmes 1

This book contains the following games and utilities:
Breakout—Find the Word—Space Pirates—Vic Vic—Birds Demo—Rhino—
Do-Ray-Me—Sound Effects—Arrow—Tank v UFO—Landmine—Spacewar—
Joystick Test—Define Keys—USA Song—Digiclock—Leap Frog—Rubik Cube—
Boss—Sketching 1—Sketching 2—Kaleidoscope—Hi-Res Demo—Bandit—
Moon Lander—Circle Demo—Hi-Res Plot—Hangman—Gomoko—Supermind—
Conquest—Hi-Res Aid—Tinymon—Racer—Car Race—Tape Search
ISBN 0 7156 1706 0 £6.95

Spectrum Programmes 1

A basic book for every user of the Spectrum - containing the following
games and utilities:
Find the Word—Space Pirates—Arrow—Landmine—Tank v UFO—Digiclock—
Leap Frog—Rubik Cube—Boss—Kaleidoscope—Bandit—Moon Lander—Gomoko—
Supermind—Conquest—Racer—Car Race—Black Hole—Space Amaze—
Labyrinth—Psychiatrist—Cavern—Dictator
ISBN 0 7156 1704 4 £6.95

VIC Graphics

This book provides the reader with an introduction to programming techniques used
to generate graphics displays on a Commodore VIC. Topics covered include:
Using colour—Two dimensional shape plotting—Shape plotting—Shape scaling and
stretching—Shape movement—Shape rotation—Plotting using matrix manipulation—
Three dimensional shape plotting
VIC Graphics is a must for every VIC user who wishes to use the machine to its
maximum graphics display potential.
The Commodore Super Expander is required to run the programmes in this book.
ISBN 0 7156 1702 8 £6.95

Spectrum Graphics

Same as above, but for the Spectrum.
ISBN 0 7156 1700 1 £6.95

Other titles in this series include **VIC Revealed**, **BBC Programmes 1**,
Dragon Programmes 1, **BBC Graphics**, **Dragon Graphics** and
Commodore 64 Revealed. Accompanying cassettes available from the publisher.
Write in for the descriptive leaflet.



DUCKWORTH

The Old Piano Factory 43 Gloucester Crescent London NW1 7DY
Tel: 01-485 3484

THE ORIC 1 PROGRAM BOOK

Vince Apps

50 programs of games, educational and
business use for all current versions.

£5.95 128 pages

You can run an obstacle race, save a
maiden from the dark knight, protect
cities from attack.

Using High Resolution Graphics
you can draw graphs, plot circles, weave
webs, make fireworks.

Budding programmers can
peek into memory, redefine characters,
input machine codes.

Available through bookshops or cheque/p.o. to

PHOENIX PUBLISHING ASSOC
14 VERNON ROAD BUSHEY
HERTS WD2 2JL

Price **£5.95** plus 55p post/pack.

NAME

ADDRESS

..... Postcode

NEW

FREE
GAME

SPIRE

FREE
GAME

MIDSUMMER MADNESS

For a limited period only, you can buy any TWO of our
VIC 20 or DRAGON 32 games for the ridiculous sum of
ONLY £5 (including VAT, postage & packing)

As if this were not enough - we are GIVING AWAY a
free MINEFIELD game to all our customers. This
means that you can buy our two best-selling games -
BUNNY & ZEPPELIN - for only £5 and you will receive
on the same cassette a copy of MINEFIELD - absolutely
FREE.

If you have ALREADY bought goods from us, do not
worry, you can still take advantage of our offer. Simply
send £1 to cover cost of cassette and P&P and we will
send your FREE game by return of post.

VIC 20 games

AMAZING
BUNNY
ZEPPELIN
BALLOON
DIGIT
SPACE ATTACK
SPACED OUT
HUNTER
TAXMAN
BATTLESTAR
BLACK JACK
MINEFIELD

Orders to

SPIRE
Computer Services
59 Blackthorne Ave
Strawberry Fields
Whitby
South Wirral
L66 2UN
The creators of

DRAGON games

LABRYNTH
AVALANCHE
PANIC
RED DEVIL
BLOCKBUSTER
DODGEM
SALVO
BREAKOUT
MINEFIELD
COMMODORE 64
available soon



(see for catalogue)

A guide to some books to help you through the micro maze

TURN OVER A NEW LEAF

WHAT TO READ IN MICROCOMPUTING, A SELECTIVE BIBLIOGRAPHY WITH ANNOTATION BY C SAIADY AND A V STOKES, PUBLISHED BY GOWER PUBLISHING COMPANY AS A 103-PAGE PAPERBACK AT £9.50

This is an admirable attempt to help more micro users decide what books suit them best.

The bibliography lists more than 400 books, dividing them into four main categories: background, languages, specific micros, and hardware and software. It also lists them by publisher, by author, and by title and comments on who would find them useful.

It provides a good guideline as to what is now available – there are, for instance, 26 titles beginning 'Basic ...'

At £9.50 it is quite costly. But it does put the micro book market into perspective, and may save its price. **Cyndy Miles**

LEGAL CARE FOR YOUR SOFTWARE BY DANIEL REMER, PUBLISHED BY ADDISON WESLEY AS A 247-PAGE PAPERBACK AT £11.95

Now that you have turned your brainwave into a software product that is bound to be the ultimate money-spinner, how do you know that you are not going to be ripped off?

To be honest, you don't. At any time prior to, during and after your product hits the streets, every shark around will be nosing about after a fast buck.

Legal Care for Your Software tries to cover this problem in detail by looking at patent law, copyright, trade secrets, trademarks, copy protection, contracts, and limited liability.

Unfortunately, it only deals with the legal aspects and implications of the US legal system. Someone has yet to produce an equivalent version for Britain.

The basic problem both here and in the US is that software usually has a short life. So safeguarding your software with legal methods involves careful examination to discover which methods should be used. Copyright is one, but has drawbacks in that it only covers 'an original expression of an idea' and not the idea itself.

This means that any public domain or copied sections are not copyright, even if the rest is.

If a copyright does not cover all your needs, you can take out a patent – but registration can take up to two years.

Bearing in mind the price of *Legal Care for Your Software*, I would recommend it only to the most serious of people. Even then, it should be used in conjunction with a lawyer. **Nic Jones**

CHOOSING A MICROCOMPUTER



CHOOSING A MICROCOMPUTER BY FRANCIS SAMISH, PUBLISHED BY GRANADA AS A 140-PAGE PAPERBACK AT £4.95

Shopping for a micro can be a big headache. That's where this book, and others like it, can help.

'Try before you buy,' warns

the author. 'Don't buy any micro through mail order unless you have been able to inspect the machine beforehand,' he adds.

There are 13 chapters in all. They skim over a wide span of subjects – hardware, software, technology, programming, and other relevant matters – to give a general feel of the micro market. A glossary of computer jargon rounds everything off.

Although supposed to be aimed at both home and business users, the book tends to favour business. In the last chapter, for instance, the home user loses out when a list of business packages is given.

Another problem which besets all books of this nature is that they can get out-of-date quickly.

But if you need some rough guidelines before reaching for your chequebook, *Choosing a Microcomputer* isn't bad value. **Wendie Pearson**

COMPUTER LANGUAGES AND THEIR USES BY GARRY MARSHALL, PUBLISHED BY GRANADA AS A 108-PAGE PAPERBACK AT £5.95

No one can say that this book alienates the newcomers. With the opening line 'A computer language is a language for communication with a computer', it takes a stand among the not-too-advanced users.

Garry Marshall takes you through Basic and out the other side to Prolog, Gino-F, Comal and Lisp.

There's a discussion of language development before a comparison of Basic with the other languages. There is also an explanation of how those languages can be used with databases, 3-D graphics, and simulation.

The instructions are made clear with program listings and diagrams, and

techniques are explained and reviewed.

The book is written in so light and easy a way that even new users will get a broad understanding of what they can do with their micros. **CM**

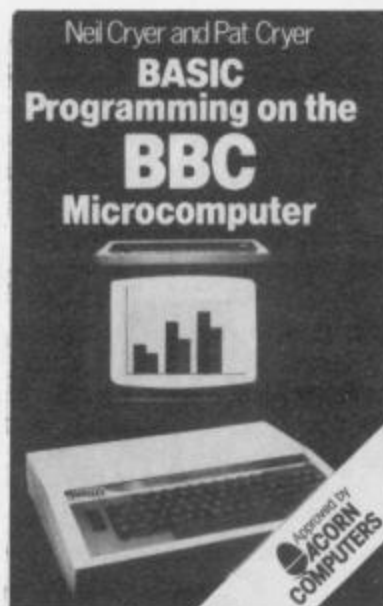

BASIC PROGRAMMING ON THE BBC MICROCOMPUTER BY NEIL AND PAT CRYER, PUBLISHED BY PRENTICE HALL INTERNATIONAL AS A 195-PAGE PAPERBACK AT £5.95

Three cheers. The authors have spotted that using variables such as X, Y, and Z complicates the issue. You could easily replace 'oil filter' for X, 'oil' for Y, and 'labour' for Z.

This book puts Basic in plain English, rather than making it look like a mathematical mess. It takes you from scratch and must surely be the toddlers' guide to learning Basic.

Chapter 9, Animation for Games, had me glued to the spot, learning how to create animated snakes and bouncing balls. And it continues to be very readable when it explains mathematical functions and string handling, file handling, programmable characters and sound.

The cherry on the top is the mine of information in the glossary and index. This book is well worth the investment. **WP**

KIPPER WILLIAMS PLAYS AROUND



Games and Puzzles from SHIVA

Brainteasers for BASIC Computers
Gordon Lee

A collection of 50 baffling brainteasers designed to be non-machine-specific.

ISBN: 0 906812 36 4 £4.95

Games to Play on Your Spectrum
Martin Wren-Hilton

A number of games and utilities to amuse or amaze you.

ISBN: 0 906812 28 3 £1.95

Spectrum Special 1
Ian Stewart & Robin Jones

A cassette of 10 programs to run on the 16K or 48K Sinclair Spectrum.

ISBN: 0 906812 42 9 £5.95

Computer Puzzles: for Spectrum & ZX81.
Ian Stewart & Robin Jones

A book of exciting puzzles to run on the Sinclair ZX Spectrum or ZX81

ISBN: 0 906812 27 5 £2.50

Games to Play on Your Oric-1
Czes Kosniowski

Games, puzzles and entertaining programs written specifically for the Oric-1.

ISBN: 0 906812 48 8 Available soon

Spectrum Special 2
Ian Stewart & Robin Jones

A further collection of puzzles and games, many with educational value.

ISBN: 0 906812 44 5 £5.95

THOUGHTS
48

Available from bookshops or direct from

Shiva Publishing Limited

4 Church Lane, Nantwich, Cheshire CW5 5RQ

Telephone: (0270) 628272



Together the ORIC-1 Micro and IJK Software bring you the dawning of a new era...

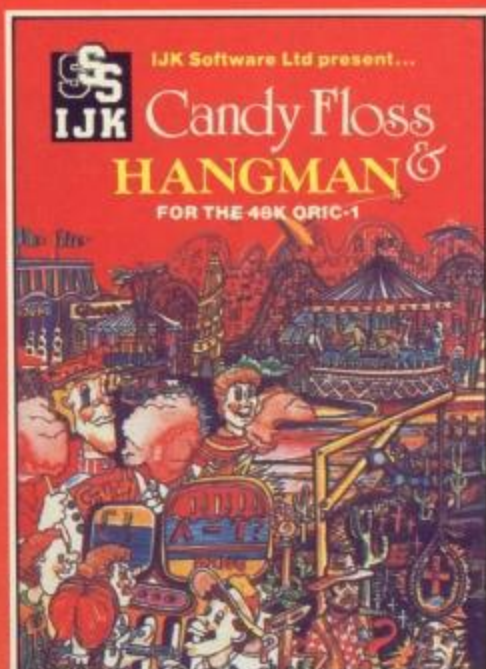

As Fleet Commander in the Xenon Space Academy, you must protect your home planet RADON from the AARDS, PARATRONS, and the ZORGON Battle Star! If you want a 100% machine code multi stage arcade game with the smoothest, meanest action around, this is the one for you - you will not buy a better arcade style game.
For the 48K ORIC-1 ONLY
Only £8.50 inc.

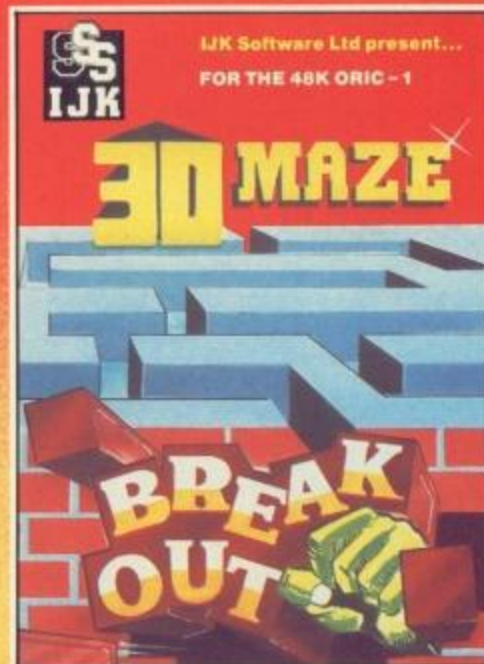

Two top educational games proven as best sellers on the BBC Micro put together here on one cassette for twice the fun on the ORIC-1 Micro for the 48K ORIC-1.
Only £7.50 inc.



Two classic games reproduced here for your ORIC-1 Micro to test your mental agility and reflexes to the full.
For the 48K ORIC-1 ONLY
Only £7.50 inc.

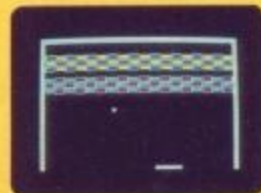

ALL PRICES FULL INCLUSIVE OF VAT AND P&P - NO MORE TO PAY

All advertised software is in stock NOW and will be despatched within 48 hours of receipt of order.

★ **SPECIAL INTRODUCTORY OFFER - DEDUCT £2 FROM TOTAL WHEN ORDERING 3 CASSETTES!**

IJK Software Limited



24 HOUR ANSAFONE

9 King Street, Blackpool, Lancs.
Telephone (0253) 21555



CHALLENGE

'Captain Kirk to Enterprise - we're trapped inside a vintage 1983 Welsh computer. Scotty, can you beam us up? Come in.'

'I'm sorry Captain. But thuh ship's in thuh grip of a tarrible force culled Basic, which is holding us and you inside the computer and leaving control of all ar lyves to thuh whim of sum 20th Century computer boffin. All ye can du is sit tight and hope thuh computer boffin knows what he's a-doin.'

'Thanks loads, Scotty. Remind me about this next time you need a wage rise. Kirk out.'

Yes, indeed. Captain Kirk and his crew have been trapped on magnetic tape and stuffed into 20th century computers by large numbers of people. The latest of these is Salamander Software's stuffing of the good ship and her crew into the Dragon 32.

The game allows you, your Dragon and its joystick to steer the ship through a variety of obstacles and strange alien encounters. You must help the starship Enterprise complete its five-year mission.

HOW TO WIN

Well, knowing how to 'win' at Star Trek has as much to do with knowing how to play video games as it does to do with knowing about the TV series that has spawned so many computer versions of the game.

In this game, the only new civilisation you are likely to find is the good old Klingons'. As the game opens, you are told that 'a force of Klingons has invaded federation space. Your mission is to rid the galaxy of this menace. Three starbases are standing by.'

The best advice is to read the manual thoroughly. You may think you know the Enterprise well. But she is a complicated ship and will need all your expert knowledge and advice to survive the hard times ahead of her.

VIDEO VERDICT

This is a must for Star Trek fans who have entered the Dragon. It neatly combines the adventure game-style text formats with some arcade action involving the Dragon joystick. A good game for both beginners, because it's challenging, and for experts - because it is so complicated you will spend a long time trying to figure out all its angles.

Price: £9.95 from Salamander Software.

Media: cassette. **Requirements:**

Dragon Data 32 with joystick.

Language: Basic.

STAR TREK



TRIK

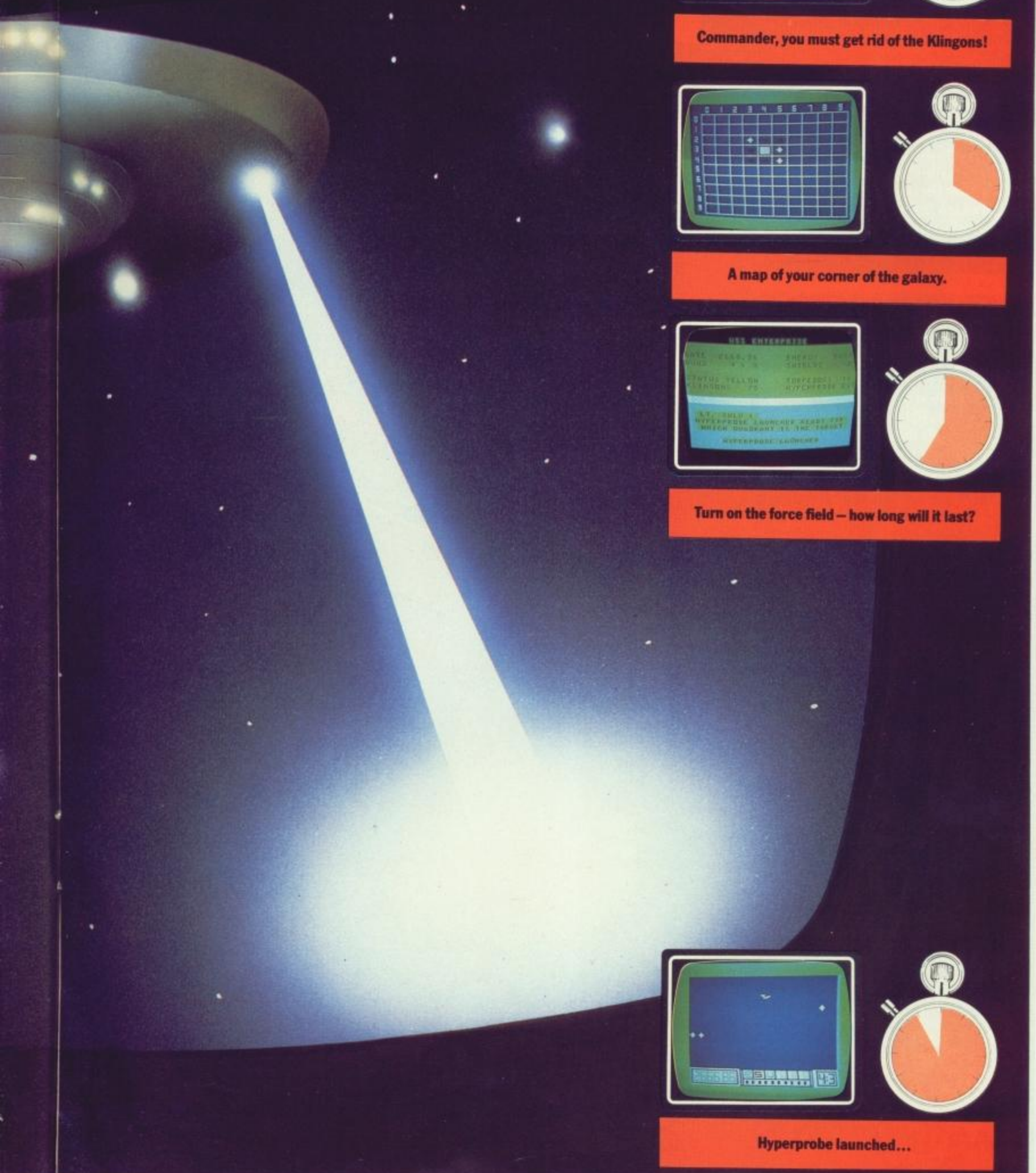

Commander, you must get rid of the Klingons!



A map of your corner of the galaxy.



Turn on the force field — how long will it last?



Hyperprobe launched...

CHALLENGE

You are, believe it or not, a frog.

As a proud member of the amphibian race, you must get yourself across a highway, then a river and safely on to your comfortable lily pad.

The players of other video games might be 'green' with envy at this seemingly simple task, but there are real hazards to prevent you from hopping your way home. The highway is full of frog-squashing traffic. The edge of the road is riddled with starving snakes. And the waters are crawling with crocodiles.

There is a bonus in your river-crossing challenge. A lady frog is languishing on one of the logs – and you get extra points from rescuing the damsel in distress and taking her home to your lily pad.

HOW TO WIN

The trick in this BBC version of the popular video game is to get an idea of the response time of your keys. Once you know how quickly the frog is going to move after you press the key (hint: it's slower than you think), you will be in a good position to get through the traffic section.

Once you get to the other side of the road, you will be relatively safe for a few moments – providing you keep a sharp eye out for the snake that patrols that side of the road.

Next comes the challenge of the logs. You will notice there are three rows of logs moving parallel to one another. The first row moves from right to left, the second from left to right and the third from right to left again.

If you miss the lady frog the first time it comes round, you can hop back and forth between the logs until you do. Don't let yourself hit the right or left of the screen, where you'll meet an untimely end.

When you are near the other side, you must look closely to make sure there are no crocodiles lurking near your lily pad. If you are successful, there will be a little fanfare.

VIDEO VERDICT

This is a good implementation of the classic amphibian video game. The controls could perhaps be more responsive than they were. But a little time spent getting the feel of the keys should solve the problem.

Price: £8.00. **Media:** cassette.
Distributors: A & F Software, 839 Hyde Road, Gorton, Manchester, M18 7JD, and most BBC micro dealers that stock A & F programs. **Requirements:** standard BBC micro and cassette recorder.
Language: machine code.

FROGGE

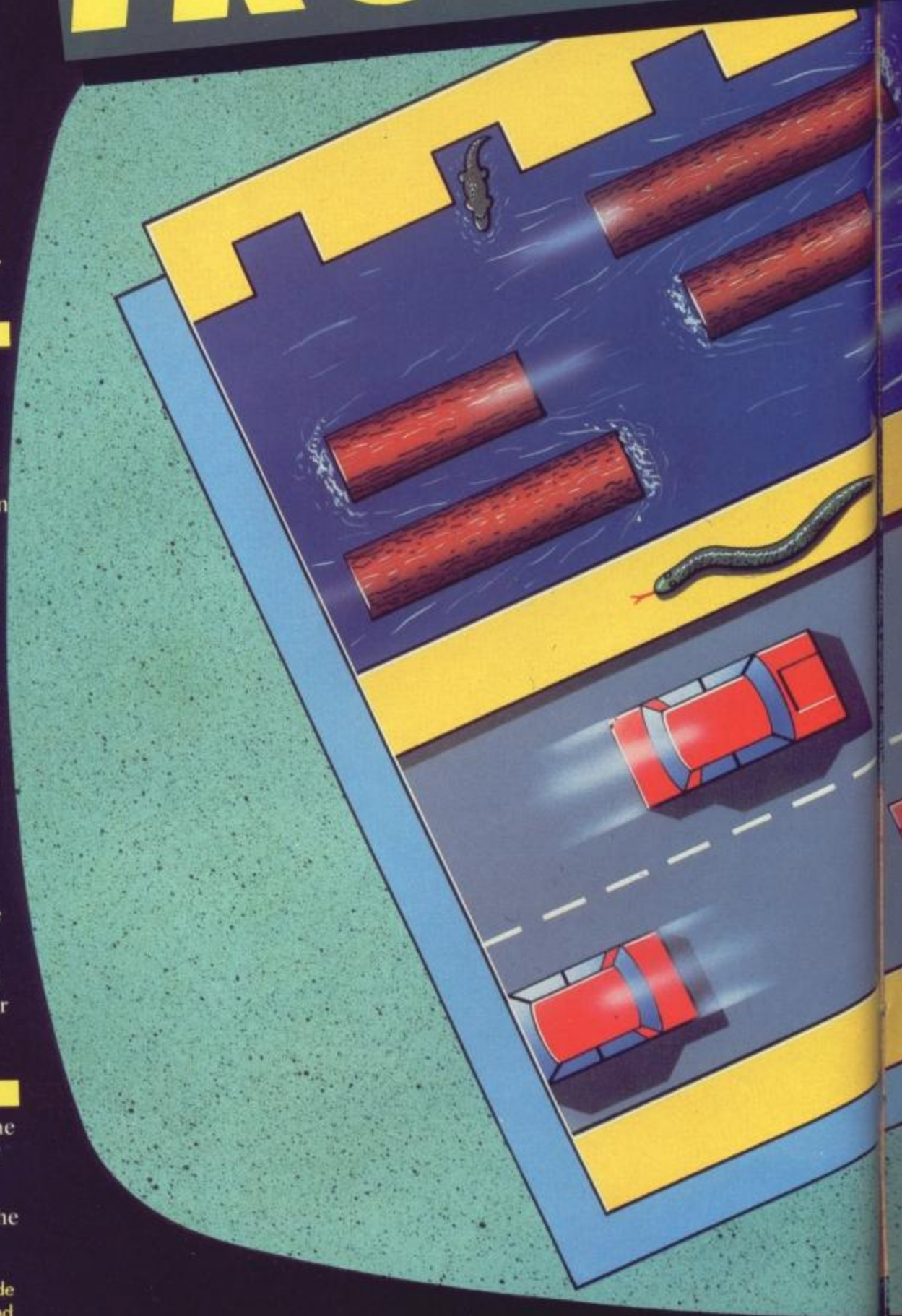

ER



Just follow the instructions. Simple, isn't it?

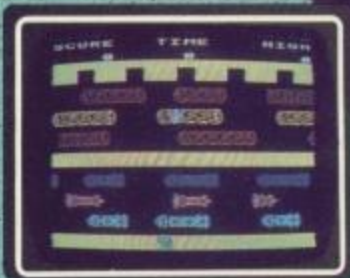

There she is, your lady frog. Run, run, run.



Don't let that snake surprise you. It's dangerous.



G-asp! Better luck next time — perhaps.

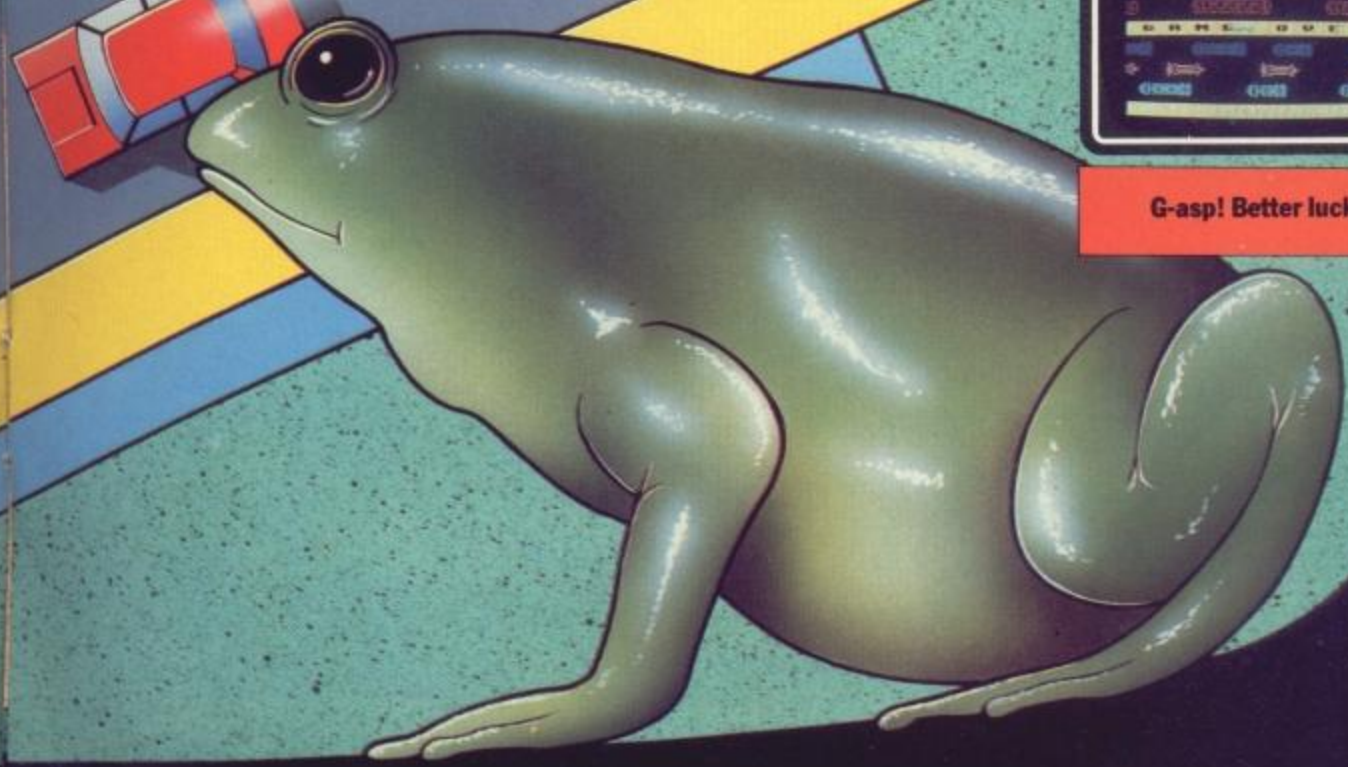

CHALLENGE

Flying the balloon in Pulsar Software's Up, Up and Away for the Atari computer would be easy – if there weren't kids with slingshots, lightning bolts from foreboding black clouds, windmills, kites and small planes all trying to pull you out of the sky.

So the main challenge is simply a matter of staying alive. If your balloon is hit by something, or runs out of fuel, it will deflate and plummet like a stone.

HOW TO WIN

Keep your eyes open and your hands tightly on the joystick. You will have to be careful from the moment you take off.

The first danger you are likely to face is the kid with the slingshot. For some reason, that kid feels the need to sling arrows at your innocent little balloon (the rotter). You can move quickly, by thrusting the joystick hard to the right, and try to avoid the shot. Alternatively, you can manoeuvre round it once the shot has been taken.

If you manage to make it past the kid, you will have either a storm or a crazy aerobatic pilot to face. The pilot seems to move completely at random. He is happy to hit your balloon with his propellor and cause your eventual downfall. As for the storm, unless you are careful a bolt of lightning will strike you with a crack of thunder.

Avoiding the previous slings and arrows was relatively simple. You will have to keep practising your manoeuvres to avoid the plane. The storm clouds are best survived by moving quickly into the spot between two clouds.

At the lower skill levels, the windmill should not pose too much of a hazard. Later, it can take considerable dexterity to survive. The trick here is to be travelling high enough and fast enough so that you don't get sucked down to the ground by the force of the suction generated by the windmill.

The kite is perhaps the trickiest challenge for beginners, but actually one of the easiest to figure out. You must restrain yourself from flying past the kite until its owner moves the kite to the right.

VIDEO VERDICT

A nice simple game without too much violence. Something to quietly get frustrated with when you have had it up to your eyeballs with the Star Raiders, Space Invaders and Pacmen.

Price: £21.95 from Pulsar Software.
Requirements: standard Atari 800/400. **Media:** cassette or disk.
Language: machine code.

UP, UP AND AWAY



GAMES

AND AWAY



Flying high – but beware that kid and the deadly kite.

ACTION
FREEZE
55

CHALLENGE

This is Space Invaders with a difference. You are a gopher and hordes of insects are invading your space. They are threatening to destroy your very own Kaktus (sic) what you planted with your own two paws.

These aren't just any old desert insects. The bugs in Kaktus (note the mild pun here and feel free to laugh any time) release acid drops. These will kill you if you get hit by them, and will destroy the cactus if you are not careful.

Since your very *raison d'être* is to protect the poor embattled cactus, it is not surprising that you should put your life on the line to save it. To ward off the pesky insect invaders, you must shoot through the hole at the top of your burrow and kill them. Your exact weapon is not clear – and gophers are not generally noted for their marksmanship.

If the bugs do manage to break through the ground above your head you can shoot them through that break in the ground.

HOW TO WIN

If you know how to win at Space Invaders, figuring out Kaktus should be no great problem. Like the shields in Space Invaders, the ground above your head can serve as an alternative place to fire through. It can also serve as a protection from the bugs blasting down on you.

You can move out of the hole and face the bugs from above ground. But unless you are highly dexterous in keeping away from the bugs, this is sheer video suicide.

If you stay above ground for too long, you run the chance of having a mole cover your hole over with dirt, trapping you in the land of the small stinging beasts. So the best strategy remains shooting from below the hole. Take advantage of any holes that are blown in the ground by using them as portals through which to blast the acid-dropping critters.

You get three lives. So you can afford to take a few chances on the first one, and perhaps pop up to the ground to rack up a few points. Then become more conservative in your play with the other two lives.

VIDEO VERDICT

A nice variation on the theme. The concept of acid-dropping insects, armed gophers and marauding moles must be ranked among the more inventive introduced for games on the Vic 20. You will need an expanded Vic to run the game – at least 8K. It will support a joystick.

Price: £7.95. **Media:** cassette.

Distributors: Audiogenic.

Requirements: expanded Vic (8K).

Language: machine code.

KAKTUS

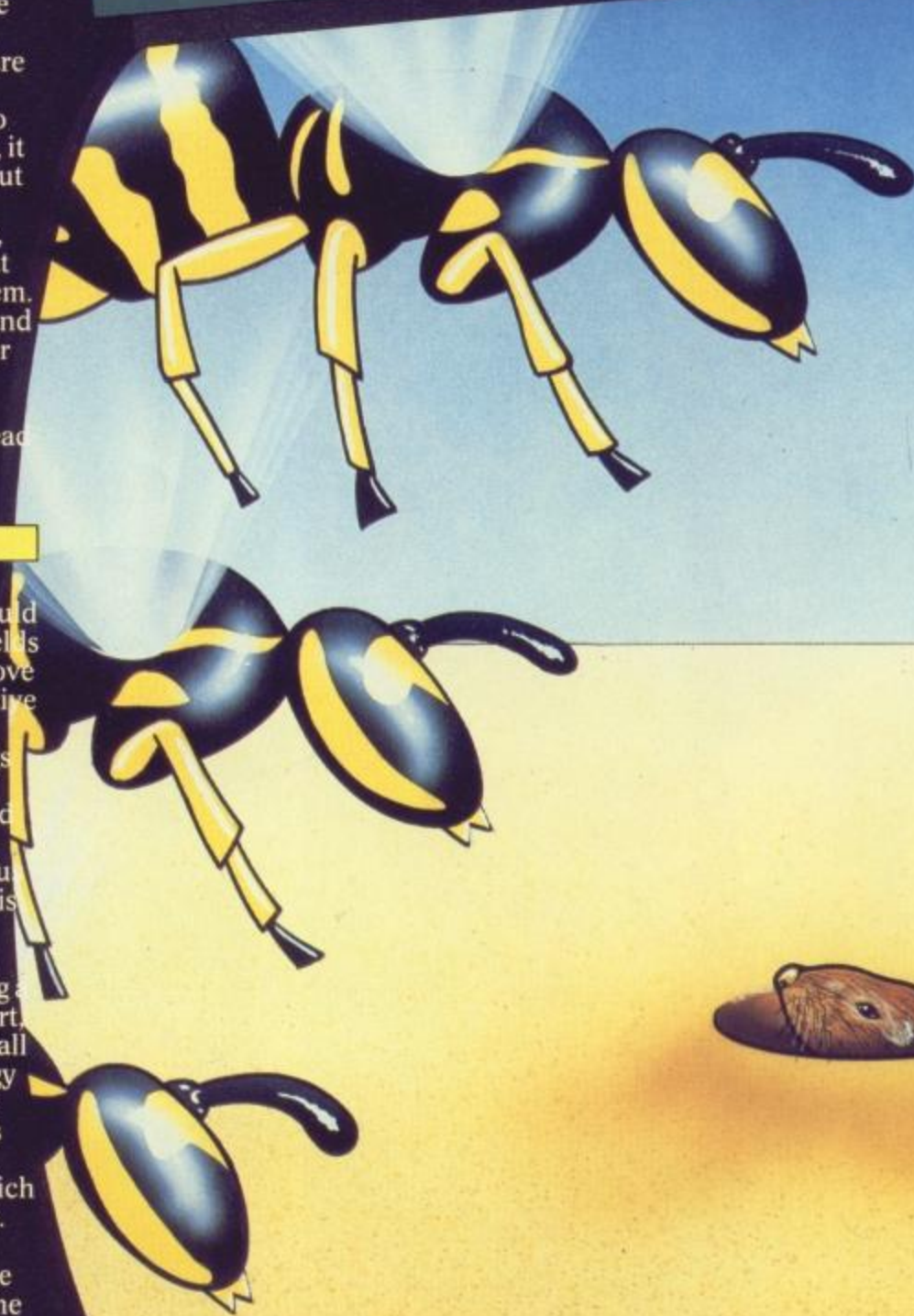
ACTION
FREEZE

56

S



Patience is a virtue when loading cassette-based programs

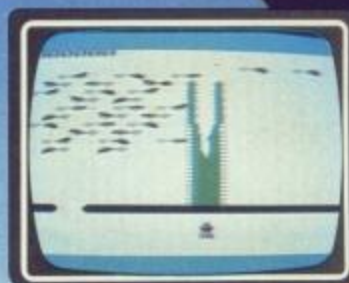

...but the screen jumps to life as you battle the bugs.



Watch that mole! You won't get a second chance.



Too late. The kaktus will soon lose its sole defender.

CHALLENGE

Flying is never an easy business. And the good folks at Oric have not deigned to make it easier with their new Oric Flight program.

You are the pilot. You control the plane. And you are responsible when it crashes – oops, I mean when it lands safely.

The Oric flight manual is a rather thin document – three pages in all. But it gives you all you need to know about the art of flying.

Think you can do it? Wait. 'Below the main screen the various instruments are provided in an easy-to-read digital form,' the manual explains. 'The artificial horizon is shown as an artificial horizon display if you are currently banking the aircraft in order to turn around. As it represents the actual visible horizon, it slants in the opposite direction to your banking.'

Well, now that we've all read out flight manuals and looked up all the tough words in our pilot's glossaries it's time to hit the skies.

HOW TO WIN

Your best friend in this game is your instrumentation, and Oric Flight's instruments are relatively non-standard issue. That doesn't mean you have a non-standard friend. Ordinary aircraft gauges and dials can be quite confusing and Tansoft's decision to represent them as digital readouts makes flying that much easier.

Start by getting your bearings. They are given as a number in the bearing readout at the bottom left-hand corner of the screen. North is 0 degrees, East 90 degrees, South 180 degrees, West 270 degrees. You must land exactly in an East-West direction.

The usual flying rules apply, as well. Keep your nose and throttle high during take-off, but bring back both once you have finished your climb. The ascent and descent rates are given in feet per second. When ascending, keep an eye on your fuel as you can fly only a certain time before you need to refuel. And running out of petrol at 30,000 feet is never fun.

VIDEO VERDICT

A good flight simulator for the Walter Mitty jet pilot set. Perhaps not as realistic as some, but the 3D action replay of your crash at the end of the game is enough to unnerve and challenge even the bravest of pilots. Entrance fees to the PCG Oric flying school are surprisingly reasonable ...

Price: £21.95 from Tansoft Software.
Requirement: 48K Oric-1. **Media:** cassette. **Language:** Basic/machine code.

FLIGHT



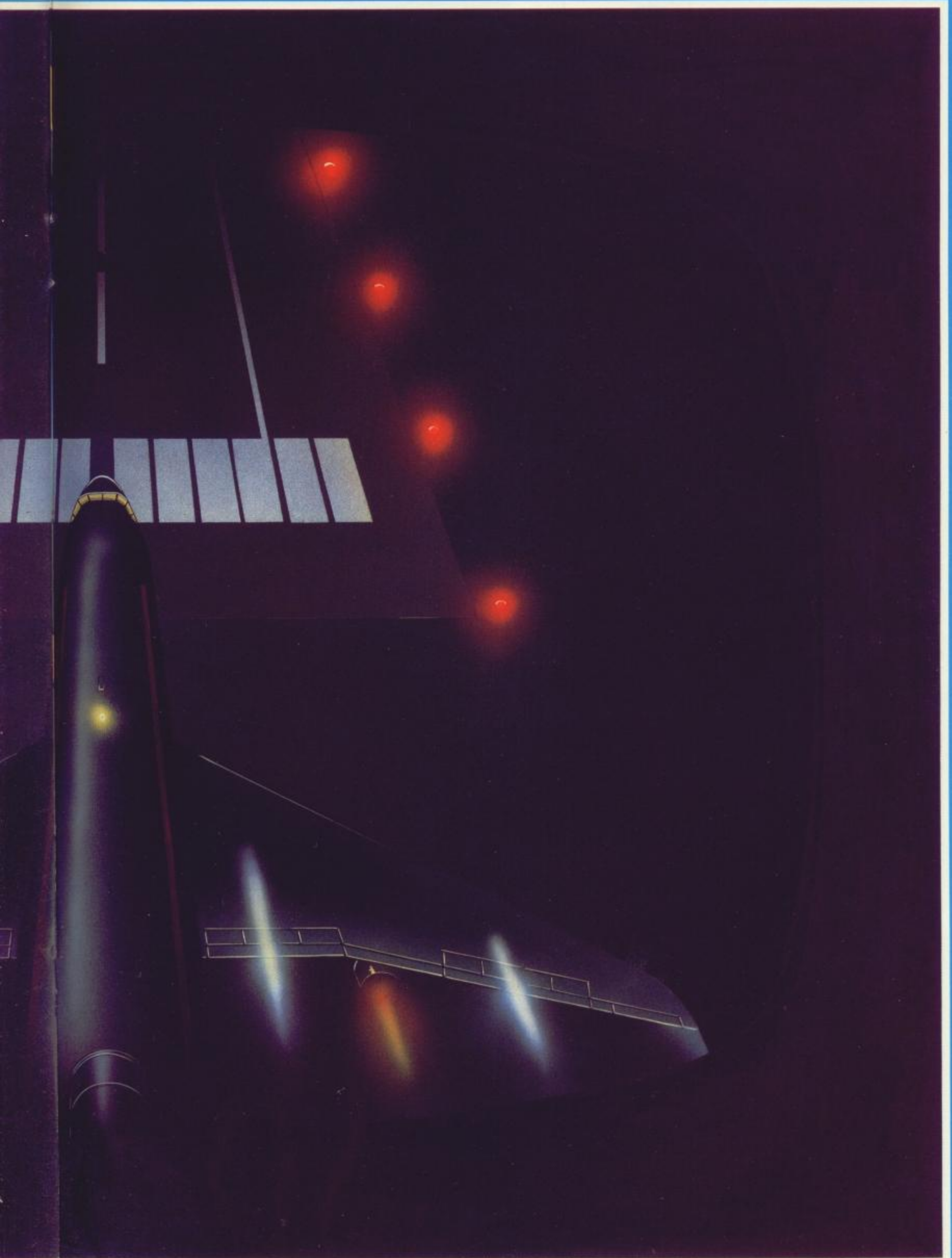

CHALLENGE

In Hungry Horace, the first of our blue friend's adventures, Horace wants nothing more than a little food to see him through his stroll in what seems to be a rather large park.

Unfortunately, there are few concession stands and food outlets in the park – most people seem content to bring their own lunches. Horace has absent-mindedly forgotten to make one of his own. So he decides to steal other people's lunches. It's your job to help him.

Horace's efforts to cadge cuisine are opposed by the park's guards who pursue him from the moment the game starts. His only defence is to ring the park alarm bells that send the guards scurrying in every direction looking for the cause of the trouble.

In Horace Goes Skiing, our intrepid hero wants merely to make his way across the road to rent skis and then move on to the slopes. He wants to show off his schussing to all the young Horacettes sunning themselves in the cool video slopes of Mount Spectrum.

In Horace and the Spiders, Horace laughs in the face of adversity as he survives – we hope – the dangers of bridge and mountain to battle a pack of deadly spiders.

For Horace novices, we will personally tackle our friend's first adventure: his food-snatching farce in Hungry Horace.

HOW TO WIN

Very carefully ... There are a few dead ends in Hungry Horace mazes. You will find Horace trapped and ready for easy capture by the park's guards if you lead him into one of those dead ends.

You must make sure Horace is never farther away from an alarm bell or exit than the guard chasing him. Make sure also that you don't get mixed up as to which button is moving Horace to which place. In moments of panic you may be likely to send poor old Horace into the waiting arms of a park guard.

The best advice is simple observation. You will soon find that some patterns work better than others in moving you through various mazes.

VIDEO VERDICT

A Spectrum classic. It's a pretty safe bet that the spiders will regret the day they met Horace and we will soon see the lovable blue blob's next episode.

Price: £5.95. **Media:** cassette.

Distributors: WH Smith and Sinclair dealers. **Requirements:** 16K Spectrum.

Language: assembler.

HUNGRY



Y HORACE

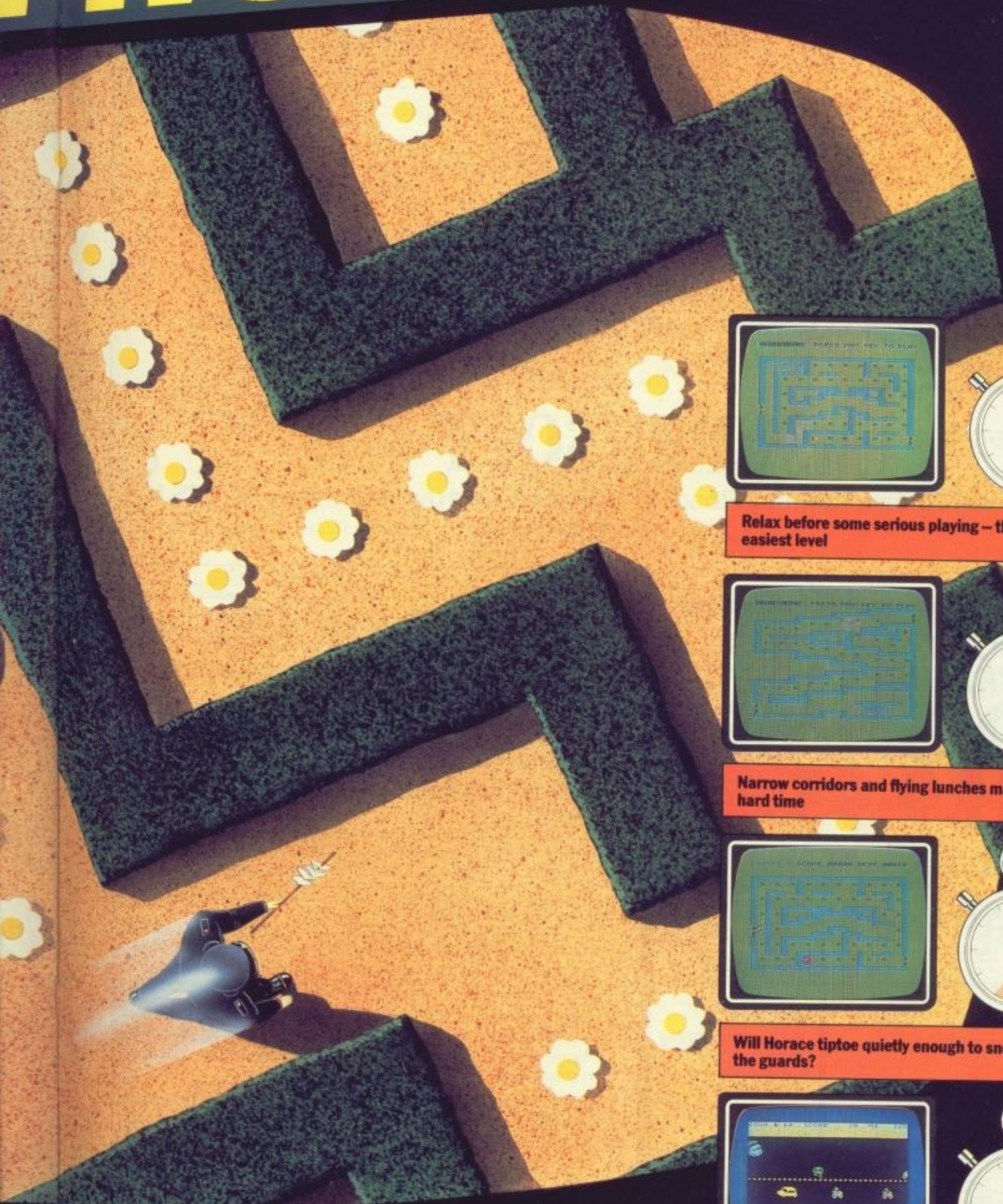

Relax before some serious playing – this is the easiest level



Narrow corridors and flying lunches make for a hard time



Will Horace tiptoe quietly enough to sneak past the guards?



Horace is unaware of trouble ahead in 'Horace Goes Skiing'

NUMBER ONE FOR FUN!

That's right! We've got the games that other software companies can only imagine.
So if you've got a Commodore 64 make a note of these titles:

**TANK ATAK
MANGROVE
CRAZY KONG
STIX
KAKTUS**

You can buy them direct from SUPERSOFT (at £8 plus VAT each, postage & packing included). Or else visit your local dealer or any larger branch of Boots.

SUPERSOFT

Winchester House, Canning Road, Wealdstone, Harrow, Middlesex HA3 7SJ
Telephone: 01-861 1166

**DON'T MISS THIS
INCREDIBLE OFFER!**

50 GAMES



£9.95

YES, 50 GAMES! on cassette for all the following:

GALACTIC ATTACK	MAZE EATER	SUBMARINES
SPACE MISSION	ORBITTER	ROCKET LAUNCH
LUNAR LANDER	MOTORWAY	PLANETS
PLASMA BOLT	FORCE FIELD	BLACK HOLE
STARTREK	NIM	DYNAMITE
RADAR LANDING	TUNNEL ESCAPE	DO YOUR SUMS
ATTACKER	BARREL JUMP	DERBY DASH
GALACTIC DOGFIGHT	CANNONBALL BATTLE	SPACE SEARCH
ZION ATTACK	OVERTAKE	UNIVERSE
INVASIVE ACTION	SITTING TARGET	HATS
OKO	SMASH THE WINDOWS	TANKER
BOGGLES	SPACE SHIP	PARACHUTE
PONTOON	JET FLIGHT	JETMOBILE
SKI JUMP	PHASER	HIGH RISE
HANGMAN	INTRUDER	THE FORCE
OLD BONES	INFERNO	EXCHANGE
THIN ICE	GHOSTS	

**sinclair
SPECTRUM**

apple (ON DISC & CASSETTE)

ACORN ATOM

BBG

DRAGON

ATARI VIC 20

SHARP

ORIC-1

NEW BRAIN

ZX81 LYNX



POSTAGE FREE TO U.K.
ORDER DIRECT TO:

U.T.S.
P.O. Box 96
53, LINCOLN GROVE
HARROGATE
NORTH YORKSHIRE
HG3 2UZ

PLEASE SEND ME _____
CHEQUE ENCLOSED, VALUE _____
NAME _____
ADDRESS _____
POSTCODE _____ PCG1

**cut &
post
now**

62 GAMES

★ STAR SOCCER ★

The ACTION Game with the Thrills of Real Football

Choose your team formation from 3-2-5, 4-2-4, 4-3-3, or 4-4-2. When the game starts, it's up to you to plan your moves and outwit your opponents. See the results played out by fast machine code routines on a birds-eye view of the pitch.

Make the split-second decisions that professionals have to!

Do I make the short safe pass and maybe let the defence regroup? Or do I try the long defence-splitting ball and risk an interception? Has my winger got the speed to take on the full-back and beat him? Do I try a long shot to catch the goalie off his line, or shall I give the ball to a team-mate in a better position?

The more games of 'STAR SOCCER' that you play, the more skilful you will become. You'll learn how to set up goal-scoring opportunities, and how to get yourself out of tight corners. You'll develop your own style of play, and find out which formation suits you best.

Side 1 features a SUPER LEAGUE competition between 8 top British teams: Aberdeen, Aston Villa, Celtic, Liverpool, Man Utd, Rangers, Spurs and West Ham. 28 games in all and the league table is automatically maintained for you.

Side 2 replays the WORLD CUP finals. It's a knock-out competition between England, Scotland, Northern Ireland, Italy, West Germany, France, Brazil, and Argentina. Lots of excitement with sudden-death extra time in drawn games.

**It's amazing how so much is packed into 16K!
Available now for ZX SPECTRUM Only £5.95**

Watson Software Services Ltd (Dept A1)

**1 Ivy Cottages, Long Road West,
Dedham, Colchester, Essex CO7 6EL**

(Trade enquiries welcome)



Algray
software



COLOUR GENIE
SOFTWARE

ALGRAY House, 33 Bradbury Street, Barnsley
ALGRAY South Yorkshire S70 6AQ, England

SKRAMBLE

Superb graphics, sound and action combine to make a superb action, arcade style game with an added bonus - Land your craft on level and you could win £100.

Colour Genie £8.95

GENMON

Guide your green spotlight through the Genies mind and implant thoughts directly with this machine-code monitor

Colour Genie £12.95

The Exterminator

Stage 1: Kill the birds, but they have guided missiles to help them.

Stage 2: Run out of the safe area, pick up the eggs and get back to the incinerator

Colour Genie £7.95

KONG

You may have seen Kong in the arcades, if not a giant ape has stolen your girl now you must rescue her avoiding the obstacles thrown at you

Colour Genie £8.95

COMPETITION FOR SKRAMBLE

Present competition entries for £100 prize etc should be sent to Algray for 31 July 83. A new competition will start shortly!

Double Agent

Your mission is to steal the plans. A role playing game in real time, so be prepared to fight or flee, to bluff, but do it quickly

Colour Genie £12.95

Fortress of Evil

An "adventure" that gives a 3-D view of the room. Your quest is to find the wizard and slay him. Using the objects you find along the way

Colour Genie £7.95

The Graphics Master

Release the potential of your Colour Genie with this easy to use method of using the programmable characters.

Colour Genie £7.95

All prices quoted inc VAT, p&p etc
- No extra to pay!!

COLOUR VIDEO GENIE - ONLY £194

INCLUDING DELIVERY AND FREE PROGRAM

Algray
software

Algray House
33 Bradbury Street
Barnsley
South Yorkshire
S70 6AQ
0924 278181

Yes I would like the following software

.....

I enclose a cheque/P.O./Access

Name

Address

.....

.....

..... Tel. No.

POSTAL BARGAINS FOR BIG GAME HUNTERS!



If you want the kind of excitement that keeps your nerve ends jangling try CDS, the games for big game hunters. But look out – it can be dangerous!

These great CDS Games are yours for only £5.95 each including post and packing. Send the coupon now.



... AND WE'LL KEEP ON COMING TO GET YOU ...
WAIT AND SEE



GOBBLE A GHOST
Moving around and gobbling up dots sounds easy. But not when 4 ghosts are constantly trying to destroy you. Kill or be killed – the 4 power pills are your answer. It's all a question of who gets who first...



CATERPILLAR
The giant caterpillar is coming to get you, helped by a horde of weird creatures. Destroy it segment by segment, blast a way through the mushrooms, kill off the ugly creatures. But don't relax... there's danger everywhere!



LEAPFROG
A frog meets many dangers on his way home. Like 4 lanes of fast moving traffic, a swirling log-filled river, plus diving turtles, frog-eating snakes and nasty alligators. Do you have the skills to see him home safely?



REVERSI
Two players locked in combat... one plays black, the other white. Only one colour will dominate. But which? Quick thinking is the key to this exciting game of skill and strategy. Especially when you challenge the computer itself.

To: CDS Micro Systems, Mail Order Dept., P.O. Box 93, Doncaster, South Yorkshire DN4 5LX

PLEASE RUSH COPIES OF THE GAMES I HAVE TICKED

- Gobbie a Ghost Caterpillar Leapfrog
 Reversi Painter Bozy Boa

Name _____

Address _____

Postcode _____

I ENCLOSE CHEQUE/P.O. FOR

£ _____

IN FULL PAYMENT



BOZY BOA



3D PAINTER

BOZY BOA
It's hectic being a boa in an English country garden. If you're lucky you'll find juicy beetles and snails. Quick left then right and in between the flowers. In a couple of hours you'll be box-eyed like me!

3D PAINTER
The bonus score is ticking away as you help the panicky painter paint the 3D maze. Can you finish before it hits zero? Will the computer outwit you? And look out – the game goes faster as you get better!



CDS Micro Systems

FOR BIG GAME HUNTERS

P.O. Box 93, Doncaster, South Yorkshire DN4 5LX

ALL CDS GAMES WORK ON THE 16K and 48K SPECTRUM

ALSO AVAILABLE FROM W. H. SMITH, BOOTS AND OTHER MAJOR COMPUTER STORES IN THE UK. TRADE ENQUIRIES WELCOME.

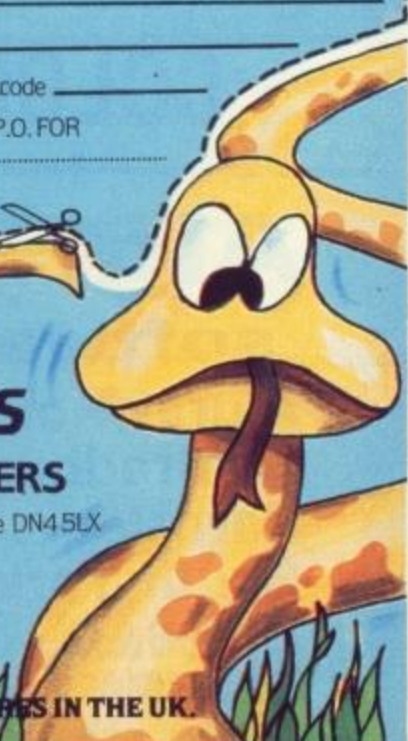

GAME FREAKS

If you want **JOY STICK** with us
(Commodore Approved)



In 3 months our Quick-Shot Joysticks have become the best sellers for VIC and Atari Home Computers. We now have a range of conversions allowing you to use the Quick-Shot for your BBC Computer, Oric and Spectrum.

For more information contact
DAVE BISHOP on: 01-203 6366

VULCAN ELECTRONICS

HI-TECH MICROSOFT

presents a new and exciting game for the Sinclair SPECTRUM 16K and 48K
£5.50 inc. p&p

LOCH NESS MONSTERS

For years now the legend of the Loch Ness monster has been in existence. There is said to be a whole clan of them living in the murky depths of Loch Ness. Well, we do not know if this is true, but in our game it certainly is. Our monsters swim around the Loch searching for food. All you have to do is catch them before you find yourselves on the menu. Beware of the reeds!
Full on-screen instructions. 100% machine code. Full musical sound. An exciting game that will bring hours of fun and enjoyment to all the family.

Dragon owners do not despair - A version for your machine is coming soon.

Trade and export enquiries very welcome.

Phone Angle on 0304 821495 now for the best dealer discounts available. Our range of software for the Jupiter Ace is still readily available, 3K or 19K. Send S.A.E./or phone for details.

HI-TECH MICROSOFT

**FREEPOST WHITFIELD
DOVER
KENT
TEL. 0304 821495**

Please send me:

- Information about The Jupiter Ace software 3K/19K. Please send S.A.E.
- More information about Loch Ness Monsters 16K/48K. Please send S.A.E.
- Please send me Loch Ness Monsters I enclose cheque/postal order made payable to HI-TECH for £5.50. Cheque/PO No. _____

Name _____
Address _____
Postcode _____

Programmers read this:

Are your programs getting **WORLD WIDE DISTRIBUTION**? If not we still require amazing programs for all makes of micro, good royalties paid. Send us your masterpiece on cassette with a S.A.E. to above address for quick evaluation.

ADDISON- WESLEY

A NEW NAME IN COMPUTER GAMES

In July, we're launching an exciting new series of games books for a wide range of home micros.

See us on
Stand 10 at
the Acorn User
Exhibition

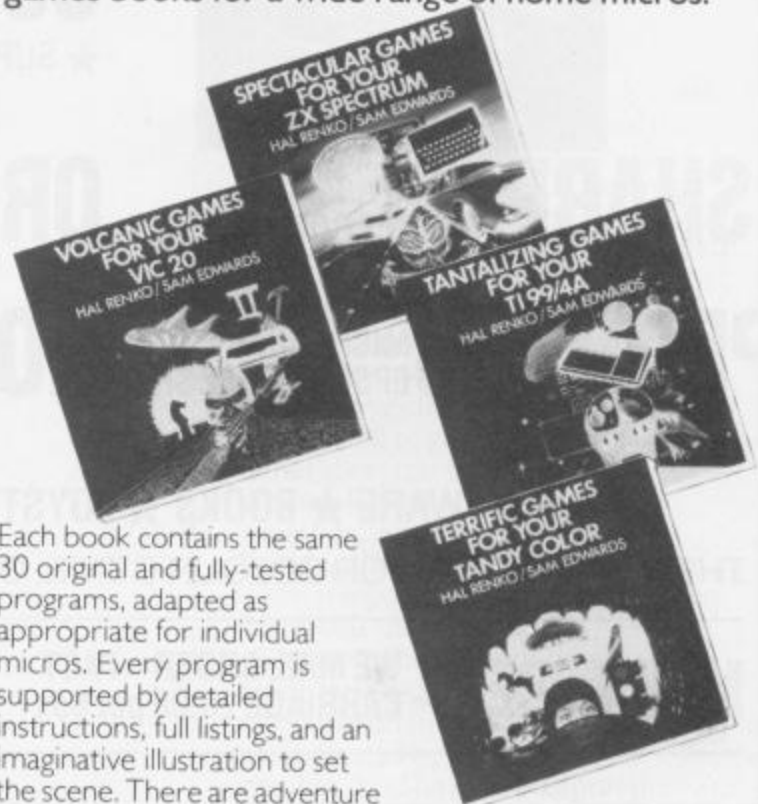

Each book contains the same 30 original and fully-tested programs, adapted as appropriate for individual micros. Every program is supported by detailed instructions, full listings, and an imaginative illustration to set the scene. There are adventure games, games of strategy and chance, puzzles, quizzes and competitions for all the family, mind-stretchers, and food for thought. Most are short enough for the average user to type in without too much difficulty, although some of the longer and more complex games require a little more work - but the end result makes it all worth while.

Coming in July

SPECTACULAR GAMES FOR YOUR ZX SPECTRUM		
192 pages	0 201 14667 3	£3.95
TANTALIZING GAMES FOR YOUR TI 99/4A		
192 pages	0 201 14669 X	£3.95
TERRIFIC GAMES FOR YOUR TANDY COLOR		
192 pages	0 201 14668 1	£3.95
VOLCANIC GAMES FOR YOUR VIC 20		
192 pages	0 201 14666 5	£3.95

Coming in September ...

ASTOUNDING GAMES FOR YOUR APPLE II		
192 pages	0 201 14674 6	£3.95
AWESOME GAMES FOR YOUR ATARI 400		
192 pages	0 201 14670 3	£3.95
DYNAMIC GAMES FOR YOUR DRAGON		
192 pages	0 201 14673 8	£3.95
SENSATIONAL GAMES FOR YOUR ZX81		
192 pages	0 201 14672 X	£3.95

From bookshops and computer stores everywhere, or by mail order direct from Addison-Wesley at the address below. There's no extra charge for postage and packing.



Addison-Wesley Publishers Limited
53 Bedford Square, London WC1B 3DZ

Phone
0533
532991

Open
Mon-Sat
9.30-5.30

ARCADE COMPUTERS

37 & 38 Second Floor,
The Silver Arcade, Leicester



SHARP PC1251, PC1500
POCKET COMPUTERS

COLOUR GENIE ONLY **£194**

★ SUPERB VALUE ★ SEND FOR FREE COLOUR BROCHURE ★

- ALSO -

ORIC-1 48k **£149.95**

UNREPEATABLE
LOW PRICE

PRINTERS MICROLINE, EPSON, SEIKOSHA **MONITORS** 9" or 12" HI-RES **SANYO** DATA RECORD £44 + £4 carr.

SOFTWARE ★ BOOKS ★ JOYSTICKS ★ UPGRADES ★ ACCESSORIES

THE VERY LATEST FOR COLOUR GENIE, ORIC, DRAGON, VIC-20, VIC-64, ZX81, SPECTRUM

MAIL ORDER - WE MAIL ORDER - FAST
CARRIAGE £6.00 per box



FREE EXPERT ADVICE ON ALL
YOUR SYSTEM REQUIREMENTS

From the people who really know... **JOYSTICKS**

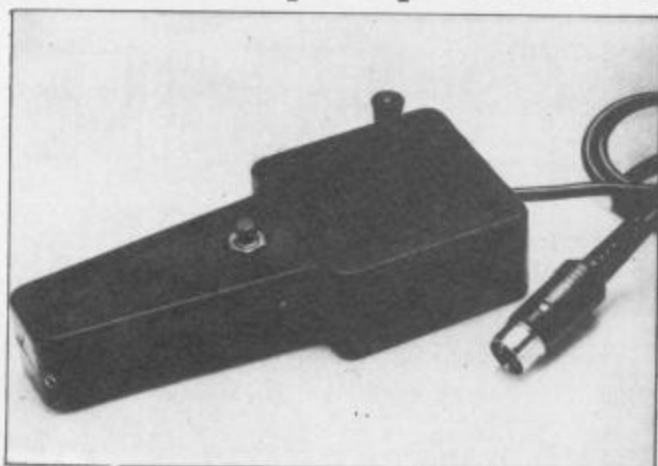

NEW

We are pleased to announce our new self-centring J7 micro-switch joysticks for computers including: VIC, ATARI, ZX81, Spectrum and others. All versions normally have the VIC 9 pin D plug configuration and are compatible with these and similar computers. The same joystick plugs into our ZX81 and Spectrum interfaces (available late June). Unlike some of the large, stiff and cumbersome joysticks available, the J7 gives precise, light and rapid operation. 4 high quality long-life micro switches give the same positive click operation as good keyboards and the whole mechanism is rated at several million cycles.

JOYSTICKS FOR: DRAGON, TANDY, BBC, VIC, ATARI, SPECTRUM, ZX81

Professional and industrial joysticks

Despite the success of our computer joysticks the major part of our business is still our wide range of high quality joysticks for all applications, from computer aided design and control panels to electric wheel chains and earthmoving equipment. In the event of even our extensive range not meeting particular requirements we build special versions quickly and economically. Recent special joysticks include single and dual axis units, 3 times normal size for a flight simulator, ruggedized versions for helicopter use and contactless units for a complex military radar system. Whatever your joystick requirement, please contact us for further information. We regret, however, that we are unable to handle direct sales for small quantities of the J6 or J7 computer joysticks - please contact your dealer.

TRADE AND EXPORT ENQUIRIES INVITED



FLIGHT LINK CONTROL LTD
UNIT 12, THE MALTINGS, TURK STREET,
ALTON, HANTS.
Telephone: Alton (0420) 87241 Telex: 858623 Telbur

GAME Backgammon
MACHINE ATOM

ATOM
BACK-
GAMMON

BY PETER ROBINSON

Backgammon players should appreciate this game. It's nicely crash-proofed and makes good use of the Atom's high resolution graphics.

It is assumed that the user knows how to play backgammon. So if you don't know how to play you will need a set of rules.

It requires the full memory expansion on the Atom - 12K RAM. All play is against the computer, which moves the black pieces. You are allowed to go first; but if you'd rather give your micro a chance, press the zero key when the prompt of 'your turn' appears on the screen. Pressing this key at any other time when it is your turn lets the computer know you can't move.

To move, you use numbers in accordance with a pair of white dice displayed on the screen. Illegal moves are indicated by a tone from the speaker. You have to position the cursor (which appears under the bottom right triangle) under the piece you want to move using the '[' and ']' keys. You then press the number key corresponding to the dice value you wish to move. This moves the piece the required number of points.

If one of your pieces is 'hit', it will appear on the bar. You will be unable to move the cursor until all your pieces have been moved from there. You can remove your pieces simply by pressing the key with the required number on it. Bearing-off is performed in the same manner as for any other move except that the piece is actually moved off the board.

Our thanks to the Anglia Computer Centre for this listing.

```

C REM *****
1 REM ****BACKGAMMON*****
2 REM ***BY P. POPIKSON***
3 REM *****XCLXXXI*****
4 REM *****
5 REM
9 P=251P.321;CJSREFFES;STA450;RTS;J;P.36
10 CLEAR;C=25000
20 F.A=10T01;S2S.2;MOVE10;A;DRAW222;A;N.
25 F.A=11T02;S2S.2;MOVEA.10;PLOTS;A.182;N.
30 F.A=1T01;Z=0;F.A=-16T00;IFA>6Z=16
40 MOVE(A*16+3+2);112;PLOT(7-(1-(A*2)))*2);(A*16+11+B+Z);182
50 MOVE(A*16+3+2);60;PLOT(7-(A*2))*2);(A*16+11+B+Z);10;N.N.
60 MOVE;10;DRAW;182;DRAW220;182;DRAW220;10;DRAW;10
70 MOVE;9;DRAW;163;DRAW221;163;DRAW221;9;DRAW;9
80 MOVE;8;DRAW;184;DRAW222;184;DRAW222;8;DRAW;8
90 F.A=1T01;MOVE(10+A);10;DRAW(10+A);182;N.
100 DIMPP26;F.A=0T02;PPA=0;N.;PP1=20;PP6=5;PP8=3;PP12=50;PP13=5
110 PP17=30;PP19=50;PP24=2
115 DIMWW4;B24;V=2800
120 IV=2FFFF7E3C;V!4=E3C7EFFFF;V!8=E3181423C;V!12=E3C428181
122 V!16=E10284444;V!20=E00101010;V!24=E44444438;V!28=E00384444
124 V!32=E44444444;V!36=V!28;V!40=E78444478;V!44=E00444444
126 V!48=E44545C44;V!52=V!44;V!56=V!24;V!60=V!28;V!64=V!32
127 V!68=E00102828;V!72=E7840407C;V!76=E007C4040
150 F.S=1T024;IFPPB<>0 GOS.C;GOS.D
170 N.
200 GOS.W;X=E331C;F.A=0T03;F.B=0T07;?(X+A+B*32)=0
220 X?(A+B*32)=(X?(A+B*32));(V?(R+16+A*9));N.N.;X=E3C5C
230 F.A=0T03;F.B=0T07;?(X+A+B*32)=0
240 X?(A+B*32)=(X?(A+B*32));(V?(B+48+A*8));N.N.
245 B=1
250 IFA=25 D=1
254 X=(12-B)*16+18;Y=10;IFB<7X=X+16
255 IFB>12 X=(B-13)*16+18;Y=184;IFB>18X=X+16
260 L=0+(192+Y)*32+X/8;?L=0;F=L
270 LINK81;E=180
276 IFPP25<>0B=25;G.290
280 IFE=91B=B+1;B=B*25;?L=255;IFB=0B=1
285 IFE=93B=B-1;B=B*25;?L=255;IFB=0B=24
290 D=0;N=0;F.A=7T024;IFPPA<9 N=N+PPA
296 N.;IF N=0 D=1
300 E=E-48;IFE<>W1 IFE<>W2 IFE<>W3 IFE<>W4 IFE<>0 G.250
310 IFE=0;?F=255;G.400
320 IFPPB>90RPPB=0 P.57;G.250
325 IF(B-E)>0 ORD=0;G.330
326 GOS.C;GOS.N;PPB=PPB-1
327 N=0;F.A=1T06;IFPPA<9 N=N+PPA
328 N.;IF N=0 A=0;G.6000
329 G.365
330 IF(B-E)<1 P.57;G.250
335 IFPP(B-E)=5 P.57;G.250
340 IFPP(B-E)>19 P.57;G.250
342 IFPP(B-E)<>10;G.360
343 B=B-E
344 GOS.C;GOS.N;PPB=0;PP0=PP0+10;X=115;Y=108+(PP0/10)*9;B=B+E
346 C=9;S=0;GOS.N
360 IFB<>25 GOS.C;GOS.N
361 IFA=25 X=115;Y=92-PP25+9;C=9
362 PPB=PPB-1;B=B-E;PPB=PPB+1;GOS.C;GOS.N;B=B+E
365 IFE=WW1 WW1=0;G.390
370 IFE=WW2 WW2=0;G.390
375 IFE=WW3 WW3=0;G.390
380 IFE=WW4 WW4=0
390 IFWW1<>0 OR WW2<>0 OR WW3<>0 OR WW4<>0 G.250
399 IFB<>25;?F=255
400 X=E8B1C;F.A=0T03;F.B=0T07;?(X+A+B*32)=0
410 ?(E8B10+B*32)=V?(B+48);?(E8B1E+B*32)=V?(B+16);N.N.;GOS.B
420 IFPP0=0 G.495
425 M=0;F=0;D=0
430 F.A=1T04;S=1;E=85A;IFE=0G.475
440 P=PPE;IFP=10 S=S+3
445 IF P=50 S=0;G.475
450 IF P<10 AND P>1 G.475
460 IFP=1 S=S+2
470 B=0;IF S>M F=A;M=S
475 N.;E=8BF;8BF=0;IFF=0;G.200
476 G.542
495 D=0;N=0;F.A=1T018;N=N+PPA/10
496 N.;IF N=0 D=1
500 M=0;I=0;DO I=I+1;P=PP1;IFP<10 G.524
501 F.A=1T04;S=0;E=8BA;IFE=0G.520
503 IFI+E=25AND D=1 S=200;G.516
504 IFI+E>24 AND D=0 G.520
505 IFI+E>24 AND D=1 S=20;IF I>25-E;S=1;G.516
506 P=PP(I+E);P=PP1;IFD=1G.516
508 IF P=30 S=0;G.520
509 IFP<10 AND P>1 G.520
511 S=(24-I)/6;IFQ=20 AND I>17 S=1
512 IFP=1 S=S+2
513 IFP=10 S=S+2+I/4
514 IF Q=10 AND P=10;S=S+3+I/3
515 IF Q>20 AND P=10;S=S+5+I/3
516 IF S=M S=S+R.X2;G.516
518 IF S>M E=I;F=A;M=S
520 N.
524 UNTIL I=24;E=8BF;8BF=0;IF M=0 G.200
525 IF(B+E)<25 OR D=0;G.542
526 GOS.C;GOS.N;PPB=PPB-10
527 N=0;F.A=19T024;N=N+(PPA)/10;N.
528 IFN=0 A=1;G.6000
530 G.595
542 IFPP(B+E)<>1;G.560
543 B=B+E
544 GOS.C;GOS.N;PPB=0;PP25=PP25+1;X=115;Y=92-PP25+9;B=B-E
546 C=9;S=0;GOS.N
    
```



GAME BOOK COMMON MACHINE *ATOM*

```

560 IFB<>0 GOS.C;GOS.M
561 IFB=0 X=115;Y=108+(PP0/10)*9;C=Q;S=0;P=PP0/10;GOS.M
562 PPB=PPB-10;B=B+E;PPB=PPB+10;GOS.C;GOS.M;B=B-E
595 IFBB1+BB2+BB3+BB4<>0 G.420
600 G.200

4995 E.
5000 CP=PP3;C=0
5010 IFP<10 G=1
5015 IFP>9P=F/10
5020 X=(12-B)+16+13;Y=20;S=-E120;IFP<7X=X+16
5030 IFP>12 X=(3-13)*16+18;Y=19;S=-E120;IFB>1PX=X+16
5035 C=B42;R.
5040 dL=(192-Y)*32+X/8+0;Z=9;IFC=0 Z=0
5050 F.A=1T0 P;F.K=0T07
5060 ??(L+K+32)=(?(L+K+32));(V?)K+2);N.;L=L+S;N.;R.
5100 nIFP=0 R.
5110 L=(192-Y)*32+X/8+0;L=L+(P-1)*6;Z=6;IF C=0 Z=0
5120 F.K=JTO7;?(L+K+32)=(?(L+K+32));(V?(K+Z));N.;R.
5200 WF.A=34T054;MOVEA,86;DRAWA,106;MOVE(A+30),86;DRAW(A+30),106
5210 N.;W1=A.R.X6+1;W2=A.R.X6+1;W3=0;W4=0;IFW2<>W1G.5220
5215 W3=W1;W4=W1
5220 Z=0;GOS.((W1*20)+5230);Z=30;GOS.((W2*20)+5230);R.
5225 bf.A=145T0767;MOVEA,86;PLOT7,A,106;MOVE(A+30),86
5230 PLOT7,(A+30),106;N.;B1=A.R.X6+1;B2=A.R.X6+1;B3=0;B4=0
5231 IFBB1=BB2;BB3=BB2;BB4=BB2
5240 Z=112;GOS.((B3+20)+5230);Z=142;GOS.((B2*20)+5230);R.
5250 X=44;Y=96;GOS.S;R.
5270 X=39;Y=101;GOS.S;X=49;Y=91;GOS.S;R.
5290 X=39;Y=101;GOS.S;X=49;Y=91;GOS.S;X=44;Y=96;GOS.S;R.
5310 X=39;Y=101;GOS.S;Y=91;GOS.S;X=49;GOS.S;Y=101;GOS.S;R.
5330 X=39;Y=101;GOS.S;Y=91;GOS.S;X=49;GOS.S;Y=101;GOS.S;X=44
5340 Y=96;GOS.S;R.
5350 F.X=3Y+049S.10;F.Y=91T0101S.S;GOS.S;N.;N.;R.
5400 sF.A=-2T02;K=2-A.A;MOVE(X+K+Z),(Y+A);PLOT6,(X+Z-K),(Y+A)
5410 N.;R.
6000 P.412;IFA=0G.5100
6010 P." I WIN!""COMPUTERS REIGN SUPREME!""
6020 G.6200
6100 P."CONGRATULATIONS ON A SKILLFUL WIN""
6200 P."DO YOU WANT ANOTHER GAME?"LINK#31;IF?E80=89 RUN
6210 E.
    
```

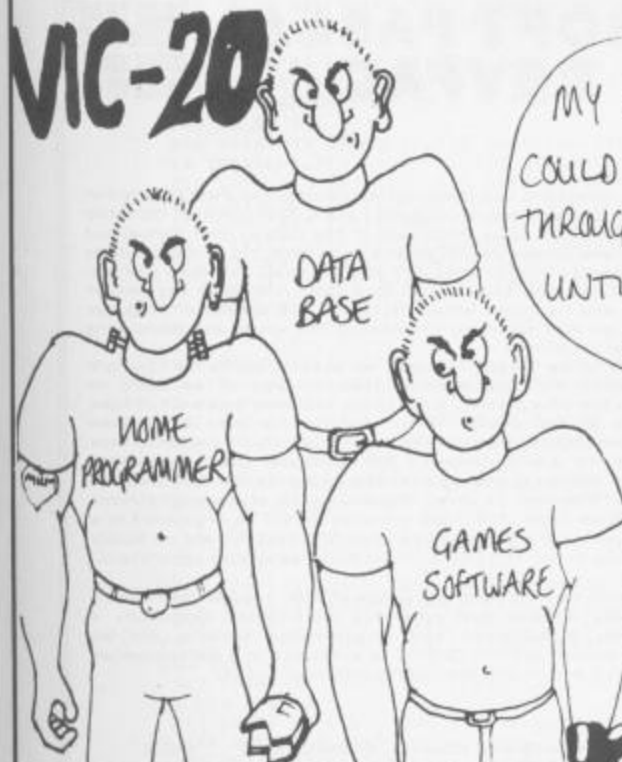
VIC-20



MY BOYS
COULD 'BYTE'
THROUGH ANYTHING...
UNTIL THESE
CAME ALONG!!

£49-99

(INCLUSIVE)

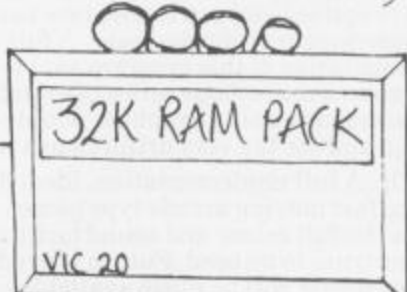

Name _____
 Address _____
 Please send me 32K RAM Pack/s @ £49.99
 Software Number 32K RAM Pack @ £59.99
 I enclose cheque/PO for £ _____
 SEND TO: **PLUS 80 LTD.**
 (No stamp needed) **FREEPOST**
HARROW
MIDDLESEX HA2 0BR
 01-423 6393

* 28159 bytes
 * Allow 7 days

'GEMINI'
SOFTWARE

1. DATA BASE
2. STOCK CONTROL
3. MAILING LIST
4. INVOICE/STATEMENT
5. HOME ACCOUNTS
6. COMMERCIAL A/C

£19.95
(inc)

BUY SOFTWARE AND RAM PACK
TOGETHER FOR £59.99 (inc)



The Wizard's Warriors

- THE WIZARD'S WARRIORS:** A fast moving game that matches developments in your skill as a player by becoming increasingly more devious. By offering to you the full range of options you can choose how to control your warrior through the maze. A full implementation of this program enables such features as a continuous series of sound effects, arcade quality graphics, double-point scoring, and-for the very artful-bonus lives.
- FORTH:** A full implementation. Ideal for writing fast moving arcade type games. Allows the full colour and sound facilities of the Spectrum to be used. Future Microdrive enhancements will be made available.
- ADVENTURE ONE:** Features a save game routine as the game can take months to complete.
- 'A remarkably good version . . . well worth the money.' ...*Sinclair User*...
- MAZEMAN:** A fast action m/c game that reproduces the spirit of the original '...is very accurate and fast.' ...*Which Micro?*...
- CHESS 1.4:** Ten levels of play with this m/c program.
- Good graphic screen display.
- 'In a class of it's own.' ...*Your Computer*...
- INVADERS:** Very fast m/c action. Includes mystery ship and increasingly difficult screens.

Spectrum £4.95

Spectrum £14.95

ZX81 £5.95

Spectrum £4.95

ZX81 £4.45

ZX81 £5.95

ZX81 £4.45

7 MAES AFALLEN, BOW ST., DYFED, SY24 5BA

24hr Ansaphone 0970 828851

JOYSTICK QUESTIONNAIRE

- Does your Joystick Handset have:
- | | |
|---|--------|
| SPRING RETURN TO OFF? | YES/NO |
| SMOOTH GRAPHITE WIPER POTENTIOMETERS? | YES/NO |
| A KEYPAD TO PERFORM MORE FUNCTIONS? | YES/NO |
| A KEYPAD TO SAVE BASHING THE KEYBOARD? | YES/NO |
| FULLY ANALOGUE FUNCTION TO WIDEN ITS USAGE? | YES/NO |
| EXCHANGEABLE OVERLAYS FOR DIFFERENT PROGRAMS? | YES/NO |

SCORE 1 FOR A 'YES' AND 0 FOR A 'NO'

If your score is over 4 then you probably already own a Voltage Delta 14B Handset.
 If your score is less than 4 then answer this question "For the price is it worth having anything less?"



Used for years by DATABASE video game owners these handsets have sprung return, nylon coated steel joysticks with graphite wiper potentiometers for longer life and SM00-00-00-THER control, plus 12 pushbuttons with two extra fire buttons to share the wear. The DELTA 14 comes in two parts. One handset will plug into the 15-way "D" plug to give analogue joystick plus three button functions. The second part is the DELTA 14B/1 adapter box which plugs onto the 15-way "D" and connects to the user port. This gives use of all 12 buttons on the user port using a 3 x 4 strobed matrix. The eighth line is used to select a second joystick which can be plugged into the adapter box. Suggested software routines included with each handset.

MADE IN GREAT BRITAIN

DELTA 14B JOYSTICK HANDSET FOR BBC £10.95
DELTA 14B/1 ADAPTOR BOX AND CABLE £13.95

Cheque or PO with order. Prices quoted INCLUDE VAT, 1st Class Post, immediate despatch - 7 day money back guarantee.

VOLTMACE LTD
PARK DRIVE, BALDOCK, HERTS. Tel: (0462) 894410
 Callers welcome Monday to Friday.

HISOFT PASCAL DEVPAC

Hisoft Pascal 4 is a very fast and powerful microcomputer Pascal compiler that is the result of three years development work. The compiler conforms very closely to Standard Pascal as described in the Pascal User Manual and Report (Jensen/Wirth) and produces Z80 object code directly in one pass; no P-codes to be subsequently interpreted. HP4 is also small (not more than 19K including runtime routines and tables) but this does not imply any lack of power - the compiler and runtimes were written in Z80 assembler language and a great deal of time was spent on increasing the speed and decreasing the size of the critical routines.

We have designed HP4 to be simple to use, very fast, close to Standard Pascal (with extensions) and inexpensive. Thus we see it as being an attractive package in the educational field (from teaching yourself at home to teaching students at university level) and in the area of systems development. To this end Hisoft Pascal 4 is available in both cassette tape and diskette versions for a wide range of Z80 machines. The tape and disk versions are virtually identical except that the cassette version does not support FILES, instead the user is given the ability to store and retrieve any variable to and from tape. The tape version (HP4T) is organised in a manner that makes it very easy to adapt to most Z80 systems and we supply details on how to do this in our HP4T Alteration Guide available separately.

In addition to our Pascal we also have available DEVPAC - a Z80 development package which includes a fast and powerful conditional assembler, a labelling disassembler, a debugger with single-step facility and (on diskette) an extended screen editor. DEVPAC is available in a limited number of formats at the moment and we are working to increase these.

Prices:

HISOFT PASCAL 4 tape version (SHARP M280A/K, NEWBRAIN etc.)	£40.25
HISOFT PASCAL 4 tape version (48K ZX SPECTRUM)	£25
HISOFT PASCAL 4 disk version (SHARP M280A/B/K, SUPERBRAIN, RML380Z, 8" formats etc.)	£46
DEVPAC disk version (Gemini 8805 or 8809 formats)	£46
DEVPAC tape version (ZX SPECTRUM only)	£14

All the above prices are fully inclusive of 15% VAT and P&P within the UK. Add £2 for orders to the mainland of Europe and £4 to other countries.

HISOFT
 60 Hallam Moor
 Liden Swindon
 Wilts. SN3 6LS
 Tel. (0793) 26616

GAME Blaster MACHINE SPECTRUM

SPECTRUM BLASTER

BY ALAN GREEN

```

5 GO SUB 523
10 REM ...Alien Blaster...
20 REM ...C Alan Green ...
30 REM ... 1982 ...*
40 FOR n=0 TO 7:FEAD j:PONE USR "A"+n:j:NEXT n
50 FOR n=0 TO 7:FEAD i:PONE USR "B"+n:i:NEXT n
60 FOR n=0 TO 7:FEAD l:PONE USR "C"+n:l:NEXT n
70 LET a=10: LET s=0: LET q=1
80 LET z=31: LET y=120
90 PRINT AT 12,4:"Do you want instructions?"
95 BEEP .1,2: LET a$=INKEYS:IF a$="y" THEN GO TO 380
96 IF a$="n" THEN GO TO 100
97 IF a$="" THEN GO TO 95
100 BORDER 1: PAPER 1: INK 6: CLS
110 PRINT AT 1,0: BRIGHT 1: INK 3:
-----:AT 19,0:INK 6:
-----
120 PRINT AT 3,2: BRIGHT 1: INK 5:"Score 0":AT 0,16: BRIGHT 1:
INK 5:"High "z$
150 LET c=INT (RND*30)+1: LET b=3
152 IF c<=5 THEN LET w=2000
153 IF c>5 AND c<26 THEN LET w=3000
154 IF c>=26 THEN LET w=1000
155 LET ch=INT (RND*2)+1
160 PRINT AT 18,a: INK 6: A "":AT b-l,c-l: " " :AT b,c:
INK 4:CHR$ (ch+144)
170 LET x=(c*5)+12
180 LET a=a+(INKEYS="2" AND a<=28)-(INKEYS="1" AND a>=1)
190 PLOT x,z: PLOT OVER 1,z
200 IF INKEYS="0" THEN DRAW INK 5:0,y: BEEP .025,20:
PLOT x,z: DRAW OVER 1,0,y: GO TO 260
205 GO SUB w
210 LET b=b+1: BEEP .01,19-b: IF b=19 THEN GO TO 230
212 PRINT AT 18,a: INK 6: A " "
214 LET a=a+(INKEYS="2" AND a<=28)-(INKEYS="1" AND a>=1)
220 GO TO 160
230 BEEP .5,-20
240 PRINT AT 18,c-l: " " : PRINT AT 21,q+2: INK 7:CHR$ (ch+144):
IF q=5 THEN GO TO 300
250 LET q=q+1
260 IF x=(c*8)+4 THEN GO TO 280
270 GO TO 205
280 FOR n=-3 TO -1: PRINT AT b,c: INK 1: INVERSE 1:CHR$ (ch+144):
BEEP .04,5-n: PRINT AT b,c: INK 2:CHR$ (ch+144): BEEP .04,n:NEXT n
290 LET s=s+(c*(ch*2)): PRINT AT 0,8: BRIGHT 1: INK 5:s:
PRINT AT b,c: " " : GO TO 150
300 PRINT AT 10,12: INK 7:"Game Over": IF s>=ss THEN LET ss=s:
PRINT AT 0,21: BRIGHT 1: INK 5:s$
305 GO SUB 600
310 PRINT AT 12,6: INK 6:"Press Y to play again"
320 IF INKEYS="y" THEN CLS: BEEP .3,30: GO TO 70
330 IF INKEYS="n" THEN CLS: STOP
340 GO TO 320
350 DATA BIN 00000000,3IN 00011000,3IN 00011000,3IN 10011001,
BIN 10011001,BIN 11111111,BIN 10000001,BIN 10000001
360 DATA BIN 30111100,BIN 01111110,BIN 11011011,BIN 01111110,
3IN 01011010,3IN 10000001,3IN 01000010,BIN 00100100
370 DATA BIN 30111100,BIN 00100100,BIN 00111100,BIN 01111110,
3IN 11111111,3IN 00100100,3IN 01000010,3IN 10000001
380 BORDER 2:PAPER 2:INK 7:CLS
390 PRINT "ALIEN BLASTER": PRINT AT 0,0:OVER 1:
-----
400 PRINT AT 2,0:"The Aliens are invading your " :AT 4,1:
"system your only hope is to":AT 6,1:"blast them before they land"
AT 8,1:"and colonise the Earth!"
410 PRINT AT 10,1: INVERSE 1: INK 7: FLASH 1:"WARNING..."
420 PRINT AT 12,1:"ONLY FIVE ALIENS HAVE TO LAND":AT 14,1:
"TO TAKE OVER !!!"
430 PRINT AT 16,1:"Press any key for next page"
440 BEEP .1,15: BEEP .1,21: IF INKEYS="" THEN GO TO 440
450 CLS
455 PRINT "ALIEN BLASTER": PRINT AT 0,0:OVER 1:
-----
460 PRINT AT 2,0:"To move base right press " :INVERSE 1:""2:""
470 PRINT AT 4,0:"To move base left press " :INVERSE 1:""1:""
480 PRINT AT 6,0:"Press " :INVERSE 1:""0:"" :INVERSE 0:"" to fire":
PRINT AT 8,0:"There are two different aliens, one scores more than
the other".
485 PRINT AT 12,0:"The aliens are worth more the nearer they are
to the planet."
487 PRINT AT 15,5: INK 5:"B...Raider": PRINT AT 17,5:
" INK 4:"C...Droid"
490 PRINT AT 21,1:"Press any key to start"
500 BEEP .2,5: IF INKEYS="" THEN GO TO 100
510 GO TO 500
520 BORDER 2: PAPER 2: INK 7: CLS
530 PRINT AT 10,9:"Alien Blaster"
540 FOR n=1 TO 40
550 BEEP .1,4: n
560 NEXT n: PAUSE 2: BEEP .5,20: BEEP .1,15: RETURN
600 FOR n=0 TO 2: BEEP .1,10: BEEP .1,15: NEXT n
610 FOR n=20 TO 0 STEP -2
620 BEEP .1,n: NEXT n
630 PAUSE 3: BEEP .25,15: BEEP .25,15
640 RETURN
1000 LET c=c-1: RETURN
2000 LET c=c+1: RETURN
3000 RETURN

```

Well, yes, it is another space-invader type game, but it has redeeming features. It demonstrates many of the special features of the Spectrum, including colour (BRIGHT, FLASH, INVERSE, etc), sound (OK, BLEEP) and user-defined graphics.

The program runs on both 16K and 48K machines and contains full instructions: the usual 'blast the aliens before they kill your grandmother and eat your pet dog'.

Please note that the 'A', 'B' and 'C' in lines 40, 50, 60, 160 and 212 respectively should be entered as graphics A, B and C. Thanks to Neil Marshall for the modifications in lines 212 and 214.

The Plaice for ATARI[®] Users

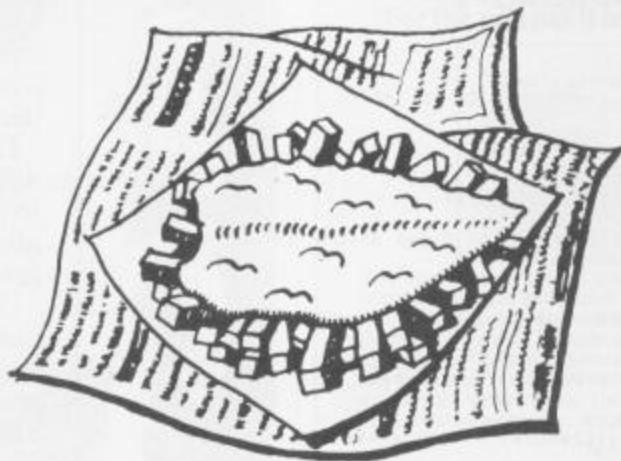

More than just a computer take away, we're the best in the Mid-West for Atari Software and Hardware. Our huge Software stock updates so fast it would be pointless to list. If you've read about it first in those superb American magazines, Computer, Analog or Antic then, if we haven't got it, we can usually get it within days. By the way, we also sell the magazines.

Special Offer
Choplifter Cartridge for Atari 400/800
£24.95 including p-p

Send Cheque or phone your Access or Visa Number.

Within easy reach from the M4 we're

efficient chips

**40 THE MARKET PLACE, CHIPPENHAM,
WILTSHIRE**

**Telephone (0249) 657744
or (0249) 654321 Ext.39**

WILTSHIRE'S BEST for VIC 20/64, ORIC & DRAGON

GAME *Adventure* in 1K

ADVENTURE IN 1K

BY IAN STANSFIELD

```
10 REM*****1k ADVENTURE*****
20 PRINT "YOU ARE IN A CAVERN"
30 PRINT "NORTH, SOUTH, EAST OR WEST?"
40 INPUT AS
50 GOTO 20
```

C VERSION

```
main()
{
char c;
START
printf("You are in a cavern...\n");
printf("North, South, East or West");
c=getchar();
goto start;
}
```

This is the ultimate transportable program. With an absolute minimum of adaptation (or none at all) it will run on any micro you might care to name, apart from those which don't support Basic – but there is only one of those at present. In fact, its transportability is quite sickening.

It is a whole adventure in well under 1K of memory. It will provide hours of fun and entertainment for all the family – as long as they are either schizoid or possessed of an IQ below 30. It is also very easy to understand and modify. Just key it in and RUN.

For the connoisseur, there is also a version written in C, for the sake of a little linguistic variety.



WESSEXSOFT 16 EASTLAKE AVE PARKSTONE POOLE DORSET

STAR TREK (Vic 20)

A 16K adventure type of program with instructions. Take charge of the Enterprise and go out into space in Search of the Klingons.

With full use made of the sound and colour on the Vic and updated information displayed on the screen all the time it becomes a game of intrigue and strategy to outwit your enemy.

Using your warp engines to move around the galaxy and its 64 quadrants to find the Klingons and starbases. Repair and re-fuel your ship. Load up with torpedoes and continue your search.

The 10 levels of play will enable the game to be played in varying degrees of difficulty giving you fewer starbases and more Klingons to destroy. The more damage you receive from the Klingons in combat the more difficult it becomes to defend yourself.

A game of skill and cunning at £9.50 including p/p.

STAR RUN (Vic 20) 16K

You are the pilot of the freighter XR8 loaded with vital equipment for the satellite planet Amethos 10 which is trying to fend off an invasion of aliens from penetrating the inner galactic empire. The satellite planet has developed a malfunction in its gyroptic stabilizers which is causing the planet to spin erratically.

The aliens will try to stop you reaching Amethos 10 but should you run the gauntlet safely then you must land in a docking bay without crashing. The controls are switched over to the cursor controls or joystick.

The XR8 has two laser cannons to help defend itself and in combat the XR8 may be damaged. There are bases along the way to re-fuel and repair.

Not an easy game to play.

There are 9 levels of play and if you found Star Trek easy then this one is for you. £9.50 including p/p.

ALARIANS REVENGE

A fast moving game of wizards and goblins based on a fable. Find the amulet and its stones and save the kingdom from monsters and the evil sorcerer. A very complex game of skill and the facility to save the game to tape has been included to enable the player to re-load at any time and continue where they left off.

A 16K game using U.D.G. full colour and sound. £9.50 including p/p.

SPRITEMASTER (CBM 64)

This program for the 64 will allow the creation of graphics on the screen. This is done one at a time so that they can be changed if desired. The colours can be arranged at the same time. The sprites can be moved around the screen using cursor controls. This helps to give some idea of what the finished creation will look like in certain positions on the screen. It also gives an idea of what the created character will look like in motion.

The sprites can be saved as data to some designated high line numbers and merged with your own program. The program can then be re-numbered to save memory. £6.50 including p/p.

SYNTHESISER (CBM 64)

A program to turn your 64 into a full synthesiser. The range includes three octaves on the first voice. Sustain, attack and decay are used to make the sound very real.

The waveforms can be changed in mid tune by the use of the function key. It is not even necessary to be able to read music but it helps. £4.50 including p/p.

GET YOUR CARDS RIGHT (16-48K Spectrum)

A card game based on the television series where the cards appear face down. The player must decide if the following cards are higher or lower. There is an amount of money to gamble. Wins are paid on getting all the cards right but bonuses are paid for pairs etc.

User defined characters have been used to add realism and the game is ideal for younger players (average age is 10 years). £4.00 including p/p.

PEG IN THE MIDDLE (14-16K Spectrum)

A game of solitaire with the option of horizontal/vertical moves or incorporating diagonal moves for the less experienced player. After 3 attempts to move a blind the player is asked if they want to see a solution.

All legal moves have been covered and it is not possible to cheat. A game for all ages and not as easy to complete as you would think. £4.00 including p/p.

Peg in the Middle/Get Your Cards Right double package at £6.00 for the two.

GEM SOFTWARE

MONSTER MINE by W.E. MacGowan

Escape from the mine, with as much money as you can, but don't get shut in, or caught by the prowling monsters. A very addictive machine code game, with superb graphics and high-score tape-save facility.

Price (Dragon & Lynx)£7.95
Price (Spectrum & ZX81)£4.95

GOLF by Pete Allen

An excellent Basic program, giving you an 18 hole course with handicaps and choice of clubs. A golfing weakness must be specified. Amazing full colour graphics and sound!!

Price (Dragon & Lynx)£7.95

SULTAN'S MAZE by Christopher Hunt

Enter the 3D Maze in search of the Sultan's jewels, but beware, your strength may run out, or, you may come face to face with the Mad Guardian's ghost. A multi-difficulty level game with fantastic graphics and sound.

Price (Dragon & Lynx)£7.95

GAMES PACK III by Christopher Hunt

REVERSI Pit your wits against the Lynx with this easy to learn yet extremely demanding board game. Five skill levels, from novice to grand master.

PONTOON An excellent implementation of a favourite card game in full colour with sound. Lynx is a mean Banker.

SNAKE Guide the snake to the food, but watch out, he will grow and must not eat the wall or himself.

Price (Lynx)£7.95

GEMPACK IV by W.E. MacGowan

Two great machine code action games, with full colour graphics. In **SEA HARRIER** you must land your plane on the aircraft carrier, after dispersing the clouds with chemical bombs, but don't hit the ship!! In **SUB CHASE** you must depth charge the wolf pack without being sunk. Both with 4 levels of play from easy to kamikaze.

Price (Dragon & Lynx)£7.95

LYNX COMPUTING by Ian Sinclair

Excellent book which the beginner will find an invaluable aid, in helping to unravel the LYNX's many varied features!!

Price£6.95

All the above cassettes are available NCW mail order or Access through:

GEM SOFTWARE, UNIT D, THE MALTINGS, STATION ROAD, SAWBRIDGEWORTH, HERTS

Telephone (0279) 723567/723518

NEW

Extend the sound capabilities of your Dragon

DRAGON 32

Dragon 32

SOUND EXTENSION MODULE

- Fully cased module plugs into cartridge port
- Provides 3 channels of sound: 3-note chords and harmonies over 5 octaves
- Uses new BASIC command. No need to 'Peek' or 'Poke'
- Many built-in sound effects (e.g. bomb, laser)
- Music and graphics can occur together without loss of speed
- Based on popular sound generator, AY-3-8910
- Two Input/Output ports included
- User manual provided, with examples



/Cheque/PO to:-

J.C.B. (MICROSYSTEMS)
29 Southbourne Road
Bournemouth BH6 5AE
Tel: (0202) 423973

ONLY
£34.95
inclusive

Write or phone for further details

IF YOU HAVE A BBC MICRO THEN YOU NEED

LASERBUG

is the newsletter of the Independent National BBC Microcomputer Users Group. If you want the best source of information on the BBC Micro you can't do without **LASERBUG**. No matter what your interest - hardware, software, business, games or education then **LASERBUG** has something for you.

Also, **LASERBUG** has available many special offers including dust covers (for computer, monitor, printer, disks), cassette leads and 1.2 ROMS FOR ONLY £5.50 INCLUSIVE - THE CHEAPEST PRICE ANYWHERE! (Members Only)

LASERBUG defies description - send off for a sample copy and you'll find that it sells itself to you. See one and you'll be hooked for life!!

Please supply me with more details about **LASERBUG** and your special offers
 a sample copy for £1.00 and an A4 SAE (17p postage)
 1 UK 12 Month Subscription for £12.00
 1 UK 6 Month Subscription for £6.00
 1 Overseas Surface Mail Subscription for £14.00
(air mail rates on application)

Please send the goods to:

NAME ADDRESS

I enclose a cheque/PO for £ p made payable to LASERBUG.

Please send the form to LASERBUG Dept. Q, 10 Dawley Rd, Colnbrook, Slough, Berks., SL3 0QH.

GAME ENGINE FAILURE MACHINE BBC

BBC ENGINE FAILURE

BY IAN WATT

```

10 REM ENGINE FAILURE BY IAN WATT
20 REM AN ADVENTURE FOR A BBC MICRO
30 DIM E(19)
40 MODE 7:K=3:W=3
50 CLS:PRINT"CHR$129"do you want instructions(Y or N) ?";
Z$=GET$:IF Z$="N" THEN 200 ELSE IF Z$="Y" THEN 60 ELSE 50
60 CLS:VDU 31,0,12,130:PRINT "If the caps lock is not on then put
it"CHR$130"on".
70 FOR Z= 1 TO 5000:NEXT Z
80 CLS:PRINT"CHR$131" You are orbiting round a planet when "
CHR$131"the engines fail."
90 FOR Z = 1 TO 5000: NEXT Z
100 PRINT"CHR$132"you have a limited time before the ship"CHR$132
"burns up in the atmosphere in which to "CHR$132"repair the engines."
110 FOR Z = 1 TO 7500:NEXT Z
120 PRINT"CHR$133"you have to direct the computer to "CHR$133
"manipulate the objects you may come "CHR$133"across."
130 FOR Z = 1 TO 7500:NEXT Z
140 PRINT"CHR$134"the computer has a fairly large number"CHR$134
"of commands therefore if one command "CHR$134"does not work
then try another."
150 FOR Z = 1 TO 10000:NEXT Z
160 PRINT"CHR$130" The program is designed so that only "CHR$130"
"the first three letters of each command"CHR$130"and object need be
typed in, although, if"CHR$130"desired, the full word may be entered."
170 PRINT"CHR$131" N.B. To move, simply type the initial"
180 PRINT"CHR$134 " eg. N for North."
190 FOR Z = 1 TO 15000:NEXT Z
200 RESTORE 1370:FOR I = 1 TO 19:READ z:E(Z)=z:NEXT Z
210 CLS:A=L=0
220 RESTORE
230 W=W+1:IF W>20 AND W<40 THEN PRINT"It is becoming warm."
240 IF W>39 AND W<60 THEN PRINT "It is hot."
250 IF W>59 AND W<80 THEN PRINT "It is very hot."
260 IF W>79 THEN PRINT "The ship is burning up."
270 IF W=100 THEN PRINT "The ship has blown up.":GOTO 850
280 IF A=5 AND E(10)<>0 THEN PRINT "You have been shot by guards.":
GOTO 850
290 IF (E(16)<>16 OR E(17)<>16) AND A=5 THEN PRINT "You have caught
a lethal disease.": GOTO 850
300 FOR B=1 TO A:READ AS:NEXT
310 VDU 31,0,3,130:PRINT AS
320 PRINT"CHR$131"Evident exits:- ";RESTORE 580:FOR C = 1 TO A:
READ D:NEXT:IF D <> 0 THEN PRINT "North:";
330 RESTORE 590:FOR C = 1 TO A:READ D:NEXT:IF D<>0 THEN PRINT":South:";
340 RESTORE 600:FOR C = 1 TO A:READ D:NEXT:IF D<>0 THEN PRINT":East:";
350 RESTORE 610:FOR C = 1 TO A:READ D:NEXT:IF D<>0 THEN PRINT":West:";
360 PRINT"CHR$132"Objects:- ";
370 H=0:RESTORE 730
380 FOR G=L TO 19:READ CS:IF E(G)<>A OR H=4 THEN NEXT ELSE PRINT":";
CS;":":H=H+1:IF H<>2 THEN NEXT ELSE PRINT " " "CHR$132":NEXT
390 PRINT "CHR$133"Inventory:- ";
400 F=0:RESTORE 730
410 FOR G=1 TO 19:READ CS:IF E(G)<>0 AND E(G)<>-1 OR F=4 THEN NEXT
ELSE PRINT":":CS;":":F=F+1:IF F<>2 THEN NEXT ELSE PRINT " "
CHR$133: NEXT
420 VDU 31,0,13,129:PRINT"-----]"
430 VDU 31,0,17,129:PRINT"-----]"
VDU 31,0,15,134
440 INOUT"Command? "B$
450 CLS:VDU 31,1,19
460 IF LEFT$(B$,3)="WEA" OR LEFT$(B$,3)="ENT" OR LEFT$(B$,3)="EXI"
OR LEFT$(B$,3)="EAT" THEN 520
470 IF LEFT$(B$,1)<>"N" THEN 490 ELSE RESTORE 580:FOR C=1 TO A:
READ D:NEXT:IF D=0 THEN 530 ELSE 520
480 IF LEFT$(B$,1)<>"S" THEN 490 ELSE RESTORE 590:FOR C=1 TO A:
READ D:NEXT:IF D=0 THEN 530 ELSE 520
490 IF LEFT$(B$,1)<>"E" THEN 500 ELSE RESTORE 600:FOR C=1 TO A:
READ D:NEXT:IF D=0 THEN 530 ELSE 520
500 IF LEFT$(B$,1)<>"W" THEN 510 ELSE RESTORE 610:FOR C=1 TO A:
READ D:NEXT:IF D=0 THEN 530 ELSE 520
510 GOTO 620
520 A=A+D:IF A=12 THEN 1090 ELSE 220
530 PRINT"No exit!"
540 GOTO 220
550 DATA Control room, Living quarters, Medical quarters,
Teleport terminal, Mine on planet
560 DATA Computer storage banks, Cargo hold, Shuttle bay,
Inside of shuttlecraft, Engine servicing room
570 DATA Weaponry, Right engine, Left engine, Supply depot, Workshop
580 DATA 0,-1,0,0,0,3,0,0,0,-3,0,0,-2,0,0
590 DATA 1,0,3,0,0,0,3,0,0,0,2,0,0,0,0
600 DATA 0,1,0,-2,0,1,0,-2,0,0,-3,-2,0,-3,-2
610 DATA 0,2,-1,0,0,2,-1,3,0,2,3,0,2,0,0
620 M=3:N=0:D=0:IF LEFT$(B$,3)="TEL" THEN 860 ELSE IF LEFT$(B$,3)=
"QUI" THEN 850 ELSE IF LEFT$(B$,3)="HEL" THEN 1040
630 RESTORE 760:FOR I=1 TO 11:READ C$:IF LEFT$(B$,3) = C$ THEN M=I

```

This adventure game will run on either a model A or model B BBC computer.

As adventures go, it is not stunningly unusual but it is fun to play. As with all decent adventures, you need a modicum of patience – but that never did anyone any harm. It has to be said that you can cheat by following the listing closely, but the penalty there lies with your own conscience ...

By way of an outline, you are in a spaceship whose engines have failed while orbiting a planet. The fact that you are in orbit means that you are in danger of burning to a crisp in the planet's atmosphere in just a few minutes. You are the hero/heroine whose job is to repair the ship and save the lives of all the grateful crew.

You must move throughout the ship and on to the planet, picking up objects (which may or may not be useful) as you go. The computer is not above offering its help if you ask it nicely.

HOME COMPUTERS

AQUARIUS

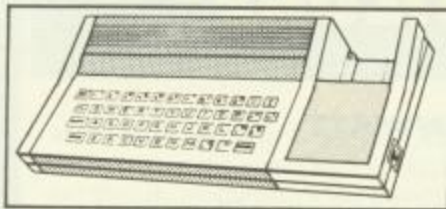

AQUARIUS: The brand new Aquarius Personal Computer is part of Mattel Electronics latest developments in advanced technology and offers full home computing facilities, as well as extensive game play, using a very wide range of plug in cartridges. Since Aquarius is a Mattel Electronics product, it benefits by the company's wide experience of producing high technology equipment, as well as their game programming expertise which is evident from the advanced games which have been produced for the Intellivision. Aquarius costs £79 and comes with microsoft basic built in. It is so simple to use that you'll be writing your first programs within minutes of taking the machine out of its box. You can even record the programs on your own cassette recorder at home, so you can use them again at a later date. Most available domestic tape recorders are compatible with the Aquarius.

A POWERFUL MACHINE: For all its simplicity, it is also very sophisticated. It has a Z80A processor and 8K of built in ROM as well as 4K of RAM, which is user expandable to 52K. It has a display of 40x24 characters, and a graphic resolution of 320x192 with a total character set of 256 (including the complete ASCII set with upper and lower case letters, numbers and additional graphic symbols). The keyboard has 49 full stroke moving keys, unlike some of the cheaper machines which have membrane keyboards. The size of the machine (excluding any of the additional peripherals), is 13"x6"x2".

PERIPHERALS: It is very easy to increase the capabilities of your Aquarius as all the peripherals plug straight into one another. You can add a Printer, a Modem, a Data Recorder, Mini Expander and other items. All of the peripherals are very easy to install and what is more, they're easy to use. But the best news of all is, they're easy to afford.

CPM OPERATING CAPABILITY: The Aquarius is capable of being expanded to 52K RAM and later in 1983 a disk drive will be available for it, with the commercial CPM business operating system. This will allow you access to one of the largest software libraries in the world, with literally hundreds of programs available for you to use.

CARTRIDGES: Various sophisticated programs will be launched on plug in cartridges such as a Visicalc type spreadsheet and a word processor. In addition there will be dozens of games and utilities and alternative languages such as Logo, which combined with the built in microsoft basic gives an unbeatable combination of high quality programming ability.

MATTEL AQUARIUS - £68.70 + VAT = £79

£79

ATARI 400/800



NEW LOW PRICES

ATARI 400/800: With the Atari Personal Computers, you can play the ultimate in T.V. games, teach yourself new subjects or skills, balance budgets, and even write your own computer programs in Basic.

SPECIFICATIONS: Both the Atari 400 and 800 can display in up to 16 colours, each with 16 intensities. They have four independent sound synthesizers for music tunes/game sounds, giving four octaves with variable volume and tone control on your T.V.'s speaker. The display graphics are of amazing quality, having a detailed resolution of 320 x 192, comprising 24 lines of 40 characters. Atari personal computers have a standard 10K ROM operating system. In addition the standard Atari 400 (£149) comes with 16K of RAM, and the expanded version with 48K (£198). The Atari 800 (£299) comes with 48K as standard. Both the 400 and 800 are now supplied with a FREE £40 Basic Programming Kit, which includes the Basic Programming Cartridge, as well as a 120 page Basic Reference Manual and the 184 page Self Teaching Manual by Bill Carris called 'Inside Atari Basic', so you can begin programming straight away, without buying any 'extras'. Even a mains plug is supplied!

OVER 500 PROGRAMS AVAILABLE: The Atari computers are supported by well over 500 programs available for your use, a larger selection than you will find on any other television game or home computer! The wide selection puts Atari way ahead of the competition. Just fill in the coupon and we will be pleased to send you a full price list which gives details of our range of software available for entertainment, home education, programming and home office use. We think you'll agree when we say it's quite impressive.

100 FREE PROGRAMS FROM SILICA SHOP: If you buy your Atari Home Computer from Silica Shop, you will receive a FREE presentation pack of 6 cassettes, containing 100 programs including games, utilities and demonstrations. A 16 page booklet giving full details of all of these programs is available on request. If you have already purchased your computer elsewhere you can buy the set of 6 cassettes for £30. What's more, Silica Shop offer a two year guarantee on all computers as well as a FREE joystick. This adds up to a great offer that we believe can't be beaten or matched by any of our competitors.

ATARI 400 16K - £129.57+VAT=£149
ATARI 400 48K - £172.17+VAT=£198
ATARI 800 48K - £260.00+VAT=£299

£149

VIDEO GAMES

COLECOVISION



THE SYSTEM: The CBS Colecovision offers new standards in video game play. The excellent graphics are well implemented with arcade titles such as Zaxxon, Lady Bug, Gorf, Wizard of Wor, Carnival, Mouse Trap and the lovable Smurfs. The console comes supplied with a three screen arcade quality version of DONKEY KONG. Parker and other companies have also announced ranges of cartridges for Colecovision, to further enhance the wide range of quality titles available for this new television games machine.

THE CONSOLE: The CBS Colecovision video games system has advanced technology which produces superlative graphics resolution and excellent sound effects. The styling of the console and hand controllers has been carefully researched; the console is designed to complement modern hi-tech equipment, and has clear features for easy operation. The hand controllers allow fingertip control via the 8 direction joystick, and feature 2 independent fire buttons. The push button keyboard is used for game selection and for game control with some cartridges. The hand controllers are detachable and are connected to six feet of telephone coil cable, storing neatly away in the console when not in use.

ATARI EXPANSION MODULE: The Atari converter module allows Atari VCS software cartridges to be played on the Colecovision console, allowing owners the freedom to purchase from the extensive range of Atari compatible cartridges. It also means that existing Atari owners can buy the CBS Colecovision games system without discarding their software library. Silica Shop offer part exchange facilities if you wish to upgrade.

TURBO EXPANSION MODULE: The Turbo Driver Expansion Module allows you to actually drive the vehicle that appears on your T.V. screen. The module consists of a steering wheel, dashboard and accelerator pedal. One hand controller is mounted on the dashboard to provide a gear change unit. The module comes complete with a Turbo Driver cartridge, the first of several cartridges to make use of the module, which provides all the action of sitting in the driving seat. This facility is unique to CBS Colecovision.

HOME COMPUTER EXPANSION MODULE: The Home Computer Module scheduled for late 1983, allows conversion of the games unit into a sophisticated Home Computer. This flexibility of design is an important feature of the CBS Colecovision System.

COLECOVISION - £127.82 + VAT = £147

£147

VECTREX



THE SYSTEM: Vectrex is a totally unique Home Arcade System, which has been exclusively designed and engineered to duplicate real arcade game play. Complete with its own monitor display, Vectrex won't cause any arguments over the use of the family's television because it has its own built in screen.

THE SCREEN: Vectrex does not use ordinary display techniques, instead it uses vector scanning to control the images on the screen. With this scanning method, the gun only updates the area of the screen that has changed, whereas a normal T.V. re-transmits the ENTIRE screen 50 times a minute. It is this that gives Vectrex its speed, and means that very little computer power is required for screen control, and the results provide very fast responding and clear images. These 'Vector Graphics' are used in several arcade games such as Asteroids and Battlezone, to give you incredibly high resolution and quality. Vectrex brings all of this from the arcade right into your living room. The Vectrex screen is capable of displaying 80 columns by 40 lines, which is significant to the extensive developments planned for the system.

EXCITING SOUNDS AND ELECTRONICS: Vectrex has an advanced microprocessor with more speed and power and exciting effects than many home video games systems.

REAL ARCADE CONTROLS: Vectrex has a unique control panel, similar to those used in many real arcade games, with 4 concave action buttons and a full 360° self centering joystick. This control panel has a 4 foot detachable cord for maximum player freedom.

REAL ARCADE GRAPHICS: Vectrex has its own 9 inch vertical screen and unlike a conventional T.V. screen, uses advanced display technology to achieve brilliant, high resolution imagery and superb game play never before possible. The Vectrex display provides special effects too, such as 3-D rotation and zooming in and out, which a regular T.V. cannot match. Using a black and white monitor, each Vectrex game comes supplied with its own coloured plastic screen overlay to add to the excitement of game play. The range of Vectrex cartridges (£21.95 each), gives a good selection of arcade games such as Berzerk, Scramble, Rip-Off and Bomber Attack. Vectrex comes complete with a fast paced 'Minestorm' game built into memory.

VECTREX: Vectrex has an advanced state-of-the-art microprocessor with more speed than other T.V. games.

VECTREX - £129.57 + VAT = £149.00

£149

WHO ARE SILICA SHOP?

Silica Shop are one of the leading specialist suppliers of Video Games & Personal Computers. We consider that our service, to those who already own or to those who are interested in any products in our range, cannot be matched by any other supplier. Just look at what we have to offer:

- * **SHOP DEMONSTRATION FACILITIES** - we provide full demonstration facilities at our shop in Sidcup, so that you can get 'hands on' experience of our range.
- * **SHOP OPENING HOURS** - we are open from Monday to Saturday 9 am - 5.30 pm, but close at 1 pm on Thursday's and Sun on Friday's.
- * **FREE MAIL ORDER** - we are a specialist mail order company and are able to supply goods direct to your door at no extra cost.
- * **FREE FIRST CLASS DELIVERY** - all orders are sent 'Door and Packing FREE', most of them being despatched by FIRST CLASS POST within 24 hours of us receiving your order details. If you require overnight delivery, this can be arranged at a charge of £3 for items under £50, or alternatively £5 for items over £50.
- * **MONEY BACK GUARANTEE** - if you are totally dissatisfied with your purchase, you may return it to us in good condition within 15 days for a full refund.
- * **PART EXCHANGE** - we will offer you up to one third of our current selling price in part exchange on your old Mattel Intellivision or Atari console (and related cartridges), if you decide to buy a new video game or personal computer from us.
- * **SECONDHAND GOODS** - we sell secondhand Atari & Atari compatibles/cartridges (with a full 1 year guarantee), at two thirds of our normal retail price.
- * **COMPETITIVE PRICES** - both our prices and services are very competitive. We are never knowingly undercut and will normally match any bona fide price quoted by our competitors, providing they actually have the goods in stock. We will also send the order to you free and packing free!
- * **HELPFUL ADVICE** - our specialist sales staff are always available to give you advice on the suitability of various computers or T.V. games.
- * **SERVICE REPAIRS** - are available on all machines in our range, often allowing you to return your machine to your own home after you buy it.
- * **ATARI SERVICE CENTRE** - we are now an authorised Atari service centre and can therefore accept repairs on all Atari equipment (TV Games and Computers) from if you do not originally purchase it from Silica Shop. All repairs during the manufacturer's 12 month warranty period will be completed FREE OF CHARGE.
- * **2 YEAR GUARANTEE** - we offer a 1 year extension on some manufacturers 12 month guarantee, including Atari Personal Computers.
- * **VIDEO GAMES AND COMPUTER CLUBS** - we offer a full information service on all video games and computers in our range. Advanced information on many new developments is often included, as you are always kept informed. We now issue regular newsletters on software releases so make sure that you join our club.
- * **OVERSEAS ORDERS** - we regularly send goods overseas and use various dispatch services. Please let us know your requirements and we will give you a quotation.
- * **PAYMENT** - we accept Access/Bankcard/Visa/American Express/Debit Card credit cards, as well as cash, cheques, postal orders, ODD or Post Office Travellers' cheques.
- * **CREDIT FACILITIES** - we also offer credit facilities with varying payment over 12, 24 or 36 months. Please send for our FREE literature and a written quotation.

01-309 1111

SILICA SHOP

SILICA SHOP LIMITED, Dept ZPCG 0883,
 1-4 The Mews, Hatherley Road, Sidcup, Kent, DA14 4DX
 Telephone: 01-309 1111 or 01-301 1111

VIDEO GAMES

ATARI

ATARI VCS (2600) - THE NO 1 BRAND LEADER IN THE U.K.

ATARI: The Atari Video Computer System known as the Atari VCS or the 2600 has now become the T.V. game brand leader. In the U.K. there are over 700,000 owners of the VCS with access to a range of over 200 different plug in cartridges, each having a multitude of different variations and difficulty levels. Every system comes complete with the main console, two individual joystick controllers, a pair of paddle controllers, aerial splitter, mains adaptor and a 27 game Combat cartridge. It gives you bright crisp graphics, realistic sound effects and even specially designed circuits for the protection of your Television Set.

SECONDHAND GAMES: We currently have several secondhand Atari VCS units in stock which we are selling for only £49 (inc VAT). This price includes the Console, with Combat Cartridge and all the accessories, as well as a 12 month guarantee. We also have stocks of several secondhand cartridges many at half price (all with 12 months guarantee). We will normally buy back secondhand units and cartridges at one third of our standard price.

EXTENSIVE CARTRIDGE RANGE: The Atari VCS is so popular that in addition to Atari's own cartridges, there are over 150 compatible cartridges, produced by at least a dozen different third party manufacturers. Silica Shop has one of the largest cartridge selections available in the U.K. Our range of over 200 titles (printed either side of this column), includes items in stock now, as well as many of the new releases for later in 1983.



SILICA ATARI CLUB: Silica Shop has over 20,000 Atari VCS club members registered on our computer. As a specialist company we are able to obtain advance information about new developments and send detailed catalogues to all of our club members, enabling them to evaluate new products before they buy. This is a totally FREE service, to receive your copies complete the coupon below.

SERVICE CENTRE: Atari International (UK) Inc has recently appointed Silica Shop as an authorised Atari Service Centre. This means that we can now service your Atari VCS or 400/800 (under guarantee if applicable), whether or not you purchased it from us.

VCS COMPUTER KEYBOARD: A keyboard will soon be launched to convert the VCS into a fully programmable home computer. For further details, join our club by completing the coupon below. We will then let you know when further information is available.

STARPATH SUPERCHARGER: The supercharger plugs into the cartridge socket of your VCS and expands its RAM almost 50 fold, from 128 to 6,272 bytes. This increased memory adds vivid high resolution graphics capabilities and significantly lengthens the game playing time. Supercharger has a range of multi-load games (at £19.45 each), these offer the facility to play a game in several distinct parts (great for adventures), the next section being loaded when you have completed the previous one, thus enhancing the game play. For further information please complete the coupon below.

ATARI VCS CONSOLE - With Combat Cart & Accessories £68.70+VAT = £79.00

- | | | | | | | | | | | | | | | | | |
|--|--|--|--|---|---|--|---|---|---|---|--|--|--|--|---|---|
| ACCESS Atari
Aerial Splitter
Joysticks
Keyboards
Mains Adaptor
Paddles | ATARI
3-D tic tac toe
Adventure
Air/Sea Battle
Asteroids
Backgammon
Basic Math
Basic Program
Basketball
Basketball (In/s)
Berzerk
Bowling
Brain Games
Breakout
Casino
Centipede
Checkers
Chess
Circus
Codelbreaker
Combat
Concentration
Defender
Demons/Diamonds
Dig Dug
Doggerel
E.T.
Football/soccer
Fun with Noes
Galaxian
Golf
Gravitar
Hangman
Haunted House
Human Cannon
Hunt & Score
Indy 500
Jungle Hunt
Kangaroo
Keychain Capers
Math G Prize
Maze Craze
Min Golf
Missile Command
Ms Pac-Man
Night Driver
Olympics
Othello
Outlaw
Pac-Man
Phoenix
Pitfall
Pole Position
Raiders of L.A.
Sky Dive
Slot Racers
Soccer
Space Invaders
Space War
Star Raiders
Street Racer
Superman | ACCESS Int'l P
Extra Lead
Joysticks
Le Stick
Pointmaster
Quick Shot
Redball
Starfighter
Straight Stick
Trackball
Triga Command
Vic Command
Wico
Zircon | ACCESS Misc
Video Storage
Units | ACTIVISION
Barnstorming
Boxing
Bridge
Chopper Cmd
Dolphin
Dragster
Elduro
Fishing Derby
Freeway
Grand Prix
Ice Hockey
Kaboom
Keychain Capers
Laser Blast
Megamania
Onix
Pitfall
Plaque Attack
River Raid
Robotnik
Seaquest
Skiing
Sky Jinks
Spider Fighter
Stampede
Starmaster
Tennis | ARCADE
Lost Luggage
Recumbent
Shark Attack
Steel Shot
Space Covers
Space Chase | ATARI/Comd
Super Breakout
Surround
Swordquest E
Swordquest F
Tennis (In/s)
Vanguard
Volleyball (In/s)
Werlock
Yars Revenge | PARKER/Con
Emp Strks Bk
Frogger
Incredible Hulk
James Bond 007
Jedi Arena
Lord of Rings
Popeye
Q-Bert
Reactor
Rtn of Jedi 1
Rtn of Jedi 2
Sky Skipper
Spiderman
Super Cobra
Tutankham | CBS/Coleco
Blus Print
Carnival
Donkey Kong
Gorf
Mousetrap
Smurf
Solar Fox
Turbo
Venture
Wings
Wizard of Wor
Zaxxon | IMAGIC
Atlantis
Cosmic Ark
Demon Attack
Dem. Attack II
Dragonfire
Fire Fighter
No Escape
Riddle of Spx
Scuba
Starstorm
Star Voyager
Trick Shot
Zona | M-NETWORK
Adv of Iron
Air Raiders
Burger Time
Comp Revenge
Frog & Flies
Hrnl Soccer
Lock 'n' Chase
Space Attack
Tron Dlv Disc
Winter Olymp | PARKER
Action Force
Amide | SPECTRVISION
Chall of Naxar
Chase Syndrome
Cross Force
Gangster Alley
Glactic Tactics
Manga
Master Builder
Phaser Patrol
Tape Worm | SUPERCHGR
Comunist Mut
Dragonstmpsr
Escape from M
Fire Ball
Killer Satellite
Phaser Patrol
Suicide Mission | TELESYS
Cocoonz
Cosmic Creeps
Demoltn Herby
Fast Food
Ram - It | TIGERVISION
Jawbreaker
King Kong
Miner 2049er
Polaris
River Patrol
Threshold | ZIMAG
Cosmic Corridor
Disaster
Immiss & Aggs
I want my Mom
Pizza Chef
Quest for Gold
Tally Ho
Tanks no Tanks |
|--|--|--|--|---|---|--|---|---|---|---|--|--|--|--|---|---|

£49

£79

ACCESSORIES

We stock a wide range of accessories for the Atari VCS and 400/800 personal computers. The same accessories can be used on the Commodore VIC range of computers. The Wico range can also be used with the Texas Instruments computers on purchasing a special adaptor. To give you an idea of the range available, just take a look at the following list:



TRACKBALL: A directional control which is similar to a jet fighter joystick.

WICO RED-BALL: An arcade type joystick with a red ball handle, it features 2 fire button locations, one at the base and one on the stick. It comes supplied with 4 grip pads for easier table top use.

WICO STRAIGHT - STICK: The main feature of this joystick is its arcade style, bat handle grip. It also has 2 fire buttons. Four grip pads included for table top use.

WICO TRACKBALL: A true arcade style trackball for use with your Atari or Commodore VIC. This product is designed to give arcade control in your living room.

12' EXTENSION LEAD: A 12' extension for Atari and Atari compatible joysticks for greater player freedom.

LE STICK: A mercury filled joystick specially made for one handed operation, with thumb fire button.

QUICK - SHOT: This joystick features a contoured handle grip, thumb trigger and optional base fire button. It is supplied with 4 sure foot suction grips.

STARFIGHTER: Neat and compact with a small direction stick. Metal interior for added strength.

VIDEO COMMAND: With a tapered handle, this joystick is for one handed use. It has



MATTEL INTELLIVISION



MATTEL INTELLIVISION: The Mattel games unit is a most versatile T.V. game which offers 3-D graphics quality for only £98. Each cartridge comes with 2 overlays which fit over the unique hand controller giving easy directions for game play. Using the handset's control disc, objects

can be moved accurately in 16 directions giving a realistic simulation of lifelike movement.

VOICE SYNTHESIS: The Intellivoice unit, price £49, is used with special cartridges where high quality synthesised male and female voices feature as part of the game play.

NEW MATTEL CARTRIDGE RELEASES: Why not complete the coupon below and join the Silica Mattel Owners Club and receive our FREE news bulletins and 16 page catalogues detailing new Mattel releases. There will soon be over ninety cartridges available for the Mattel, and a small selection from these is listed below:

MATTEL: Arctic Squares, Burger Time, Buzz Bombers, Chess, Cloudy Mountain, Loco Motion, Mission X, Mystic Castle, Sharp Shot, Solar Sailor, Space Shuttle, Vectron, Winter Olympics.

ACTIVISION: Happy Trails, Pitfall, Stampede.

CBS: Blue Print, Carnival, Donkey Kong, Gorf, Mousetrap, Smurf, Solar Fox, Turbo, Venture, Wizard of Wor, Zaxxon.

IMAGIC: Buzzer, Dracula, Ice Trek, Nova Blast, Safecracker, Swords & Serpents, Tropical Trouble, White Water.

PARKER: James Bond 007, Lord of the Rings, Popeye, Q-Bert, Spiderman, Star War, Super Cobra, Tutankham.

COMPUTER KEYBOARD: In July/August 1983, Mattel will be launching their new £89, 49-key computer keyboard attachment called 'Lucky' which is fully programmable and has microsoft basic built in. It will transform your Master Component into a home computer. The adaptor also accepts a 6 note polyphonic music synthesiser and full size 49-key piano keyboard that will make learning music as easy as playing games.

MATTEL CONSOLE £85.22 + VAT = £98.00

£98

VIDEO GAME CLUB

In a fast moving market like video games, it is difficult to keep up to date with all the developments that take place. With new programmes and accessories being introduced at a fast rate by several different manufacturers, it is impossible to get all the information you require from one manufacturer alone. It is for this reason, that we have set up owners clubs for the more popular video games and home computers, to keep you fully up to date with what is going on with your particular machine. As far as we know, Silica Shop are the only company to offer such clubs, but that is not surprising since we are the specialists. We currently have FREE clubs for the Atari VCS, Atari 400/800 home computers, and Mattel Intellivision. Soon we will have clubs for Colecovision, Aquarius and Vectrex. So if you own one of these machines, fill in the coupon opposite, and we will enrol you FREE OF CHARGE in the club relevant to your computer or video game.

01-309 1111

SILICA SHOP

SILICA SHOP LIMITED, Dept ZPCG 0883,
1-4 The Mews, Hatherley Road, Sidcup, Kent, DA14 4DX
Telephone: 01-309 1111 or 01-301 1111

FREE LITERATURE

FREE LITERATURE - Please send me your FREE LITERATURE and catalogues on the following items:

OWNERS CLUB - I already own the following products, please enrol me in your FREE club:

Mr/Mrs/Miss: Initials: Surname:

Address:

Postcode: ZPCG 0883

FREE LITERATURE

THE SPECTRUM GAMES COMPANION

Bob Maunder

LINSAC

**ONLY
£5.95**

ISBN 0 907211 02 X

'The Spectrum Games Companion' is the latest addition to the series and is aimed at the games player and programmer alike. Twenty-one games designed specifically for the ZX Spectrum are included, with clear instructions on entry and play. Each program is explained fully with complete details on how it is designed and written. Introductory chapters show how to set up and use the Spectrum and how to create your own games. Later sections cover number games, word games, board games, simulation

games, dice games, card games and grid games. If you want to enjoy your ZX Spectrum and learn its secrets at the same time then this is the book for you!

Bob Maunder is co-author of 'The ZX80 Companion' and author of 'The ZX81 Companion'. He is a Senior Lecturer in Computer Science at Teesside Polytechnic, holds an MSc degree in Computer Science, and is a Member of the British Computer Society.

The Spectrum Games Companion is available from good book shops, or send £5.95 to:

**LINSAC, (P.C.G.) 68 Barker Road,
Middlesbrough, Cleveland TS5 5ES**

Postage is free within the U.K. —
add £1 for Europe or £2.50 outside Europe.

Linsac's ZX Companion series has received excellent press reviews:

"Far and away the best" — *Your Computer*

Thoughtfully written, detailed and illustrated with meaningful programs ... outstandingly useful" — *EZUG*

ZX81 HIGH RES GRAPHICS

- * Full 256 x 192 pixels
- * Extended Sinclair Basic commands
- * Comprehensive Manual
- * Screen copy to printer
- * User defined graphics

See reviews in Personal Computer World and Sinclair User. This is a fast, easy to use hardware add on for the ZX81 that extends its graphics facilities beyond even the Spectrum!!

ONLY £30 incl. VAT&P

BBC BREADLINE

Plugs into the user port and brings out all the connections to wire sockets (8 Data + 2 Handshake + 2 Power). It has on board, 8 LEDs with darlington drivers, 8 switches and one solderless bread-boarding socket (165mm x 55mm) (guaranteed for life) IDEAL for developing interfaces and peripherals etc.

ONLY £27.50 incl. VAT&P

AVAILABLE MAIL ORDER FROM

NOTTING DALE TECHNOLOGY CENTRE

191 FRESTON ROAD, LONDON W10 6TH 01-969 0819

GAME ENGINE FAILURE MACHINE BBC

```

640 NEXT I:IF M<>0 THEN 660
650 PRINT"I do not understand you.":GOTO 220
660 RESTORE 730:DS=RIGHTS(BS,3):FOR J=1 TO 19:READ CS:CS=LEFTS(BS,3)
670 FOR K=4 TO 15:IF LEFTS(DS,1)<>" " AND CS=MIDS(DS,2,4) THEN N=1
680 IF CS=MIDS(DS,2,4) THEN O=J ELSE DS=RIGHTS(BS,K)
690 NEXT K:NEXT J:IF O<>D THEN 700 ELSE PRINT "Pardon?":GOTO 220
700 IF N=1 THEN PRINT"Learn to tyoe."
710 ON M GOTO 780,990,940,970,1090,1130,1170,1200,1240,1270,1300
720 GOTO 220
730 DATA BLUE BUTTON,RED BUTTON,YELLOW BUTTON,LIGHT-BLUE,LIGHT-RED,
LIGHT-YELLOW
740 DATA ASTRAGEM,SHUTTLECRAFT,FLOPPY DISK,ZAPPERGUN,SPACESUIT,
SCREWDRIER,PANEL,LEVER
750 DATA JEWEL-SOCKET,WATER,TABLET,PLIERS,PCB
760 DATA PRE,GET,DRO,INS,WEA,ENT,EXI,UNS,PUL,DRI,EAT
770 PRINT "I cannot do that.":GOTO 220
780 IF O<>3 THEN 770
790 IF O=2 AND E(15)=16 THEN 1330
800 IF O=2 AND E(5)<>1 OR O=1 AND E(4)=1 OR O=3 AND E(6)=1
THEN PRINT"The ship has blown itself up.":GOTO 850
810 IF O=3 AND E(4)=1 THEN PRINT"A yellow light comes on.":
E(4)=16:E(6)=1:GOTO 220
820 IF O=1 AND E(6)=1 THEN PRINT"A pcb has just materialised in part
of the ship.":E(16)=16:E(19)=10:GOTO 220
830 IF O=1 OR O=3 THEN PRINT"Nothing happens.":GOTO 220
840 PRINT"The teleport has been activated.":L=1:E(5)=16:GOTO 220
850 VDU 23;11,0;0;0;31,5,23:PRINT"Press space to start again.":
IF INKEYS(50)=" " VDU 23;11,255;0;0;0;:GOTO 40 ELSE VDU 31,5,23:
PRINT" ":IF INKEYS(50)=" " VDU 23;11;255;0;0;0;
0;:GOTO 40 ELSE 850
860 IF L=0 OR A<> 4 AND A<>5 THEN 770
870 IF A=4 THEN A=5 ELSE IF A=5 THEN A=4
880 PRINT"O.K.": GOTO 220
890 IF O<7 OR O=8 OR O=13 OR O=14 OR O=19 THEN 770
900 IF F=4 THEN PRINT"I am carrying too much.":GOTO 220
910 IF E(O)<>A THEN 930
920 E(O)=0:GOTO 890
930 PRINT "I do not see it here.":GOTO 220
940 IF E(O)<>0 AND E(O)<>-1 THEN PRINT "I am not carrying it.":GOTO 220
950 IF H=4 OR A=1 THEN PRINT"I do not see a place to put it.":GOTO 220
960 E(O)=A:GOTO 890
970 IF O<>9 AND O<>7 AND O<>15 THEN 770
980 IF E(O)<>D AND E(O)<>-1 THEN PRINT"I do not have it to insert.":
GOTO 220
990 IF A<>1 AND O=9 OR O=7 AND E(15)<>0 OR O=15 AND A<>10 THEN PRINT
"I do not see a place to insert it.":GOTO 220
1000 IF O=7 THEN E(O)=16:E(15)=-1:GOTO 890
1010 IF O=9 THEN 1030
1020 IF O=15 AND E(18)=0 THEN E(O)=16 ELSE 770
1030 PRINT "A red light comes on.":E(5)=1:E(4)=16:E(9)=16:GOTO 220
1040 IF A=9 AND E(9)=0 THEN PRINT "Try inserting the floppy disk.":
GOTO 220
1050 IF A=13 THEN PRINT"Try unscrewing the panel.":GOTO 220
1060 IF A=2 OR A=3 THEN PRINT"A tablet taken with water prevents the
catching of a lethal disease.":GOTO 220
1070 PRINT"There is no help available to give.":GOTO 220
1080 PRINT "Your pet ORIGOVK has mistaken you for an intruder and
killed you.":GOTO 850
1090 IF O<>11 THEN 770
1100 IF E(O)<>0 AND E(O)<>-1 THEN PRINT"I am not carrying it.":GOTO 220
1110 IF E(O)=-1 THEN PRINT"I am already wearing it.":GOTO 220
1120 E(O)=-1:GOTO 890
1130 IF O<>8 THEN 770
1140 IF A<>8 THEN 930
1150 IF E(11)<>-1 THEN PRINT"You have been destroyed by nerve gas.":
GOTO 850
1160 A=9:GOTO 220
1170 IF O<>8 THEN 770
1180 IF A<>9 THEN PRINT"I am not inside it.":GOTO 220
1190 A=8:GOTO 220
1200 IF O<>13 THEN 770
1210 IF A<>13 THEN 930
1220 IF E(12)<>0 THEN PRINT"I need a screwdriver.":GOTO 220
1230 E(14)=13:E(13)=16:GOTO 890
1240 IF O<>14 THEN 770
1250 IF E(14)<>A THEN 930
1260 PRINT "A blue light comes on.":E(4)=1:E(5)=16:GOTO 220
1270 IF O<>16 THEN 760
1280 IF E(O)<>0 THEN PRINT "I do not have any water.":GOTO 220
1290 E(O)=16:GOTO 380
1300 IF O<>17 THEN 760
1310 IF E(O)<>0 THEN PRINT"I do not have a tablet.":GOTO 220
1320 GOTO 1290
1330 PRINT "Congratulations----The ship is now fully operational."
1340 Q=100-W:IF Q<X THEN X=Q
1350 PRINT"Score=";Q;" Best score=";X
1360 GOTO 850
1370 DATA 1,1,1,16,16,16,5,8,6,11,14,9,13,16,15,2,3,7,16

```

6 NEW GAMES FOR YOUR

commodore 64

**INTERCEPTOR
MICRO'S**

PRESENTS

SEND S.A.E.
FOR FULL LIST OF GAMES



2 NEW GAMES FOR YOUR ATARI 400/800-16K

NEW GAME FOR YOUR BBC MODEL B



NEW VIC 20 GAMES

Mr, Mrs, Miss _____					
Address _____					
Quantity	Item	Total		Item	Total
	Scramble 64	£7.00		Galaxzions VIC 20	£5.00
	Star Trek 64	£7.00		Fantazia VIC 20	£6.00
	Frogger 64	£7.00		Crazy Kong VIC 20	£6.00
	Panic 64	£7.00		Frog VIC 20	£4.00
	Crazy Kong 64	£7.00		Alien Attack VIC 20	£6.00
	Spriteman 64	£7.00		Vic Rescue VIC 20	£5.00
	Fighter Pilot	£7.00		Penny Slot VIC 20	£4.50
	Wordhanger	£5.00			
	Intruders	£5.00			
	Jupiter Defender	£6.00			

Send Cheque/P.O. with Order to: Interceptor Micro's, Lindon House, The Green, Tadley, Hants.

Postage & Packing .50p

PC GAMES

STOP PRESS 1 NEW VIC 20 FALCON FIGHTER STOP PRESS STOP PRESS
ONLY £6.00

GAME *Flashback*
MACHINE *Atari*

**ATARI
FLASHBACK**

BY G CHEUNG

```

10 REM **FLASHBACK BY GWK CHEUNG
20 REM
30 DIM A$(1),P$(19),Z$(19),N$(18),PCE(),N3C(),NWC(),NTE():GOTO 90
40 REM
50 REM **SF FOR RANDOM NUMBERS
60 FOR J=1 TO N:N(CJ) = INT(RND(0))+L+1:NEXT J:RETURN
70 REM
80 REM **SETTING UP MUSIC NOTES
90 FOR J=1 TO 8:FEAD F1:N(CJ) = F1:NEXT J:DATA 31,63,95,127,159,
191,223,255
100 REM
110 REM **M/C TO SET UP PLAYERS
120 FOR J=1 TO 19:HEAD PB:P$(J,J) = CHR$(PB):NEXT J:Z$ = P$:
Z$(9,9) = CHR$(255):Z$(16,16) = CHR$(60)
130 DATA 104,104,133,204,104,133,203,169,0,160,0,145,203,200,
192,255,208,249,96
140 HS = 0:REM **FESET HIGH SCORE
150 GOSUB 620
160 L = LEV*2+N = LEV+3 :GOSUB 60
170 REM
180 REM ** SET UP DISPLAY FOR GAME
190 GRAPHICS 18:PKE 710,0:POKE 711,15
200 REM
210 REM **NE (J) = NUMBERS IN BLACK NWCJ) = NUMBERS IN WHITE
220 FOR J=1 TO 8:NB(CJ)=144+J:NWC(J)=208+J:NEXT J
230 REM
240 REM ** POSITION OF NUMBERS ON SCREEN
250 S=PEEK(56)+256+PEEK(561)+4: S=PEEK(5)+256+PEEK(5+1)
260 FOR J=1 TO 4:F(CJ)=S+60+4+J: P(4+J)=S+140+4+J: NEXT J
270 FOR J=1 TO 4:FOKE P(CJ)+NB(CJ):NEXT J
280 POSITION 3,0: ? #6: "Flashback":POSITION 2,10: ? #6:
"HIHSCORE=";HS
290 REM
300 REM ** SOUND VIBRATIONS
310 GOSUB 1000: SOUND 0,0,0,0:POKE 53760,4:POKE 53761,168:
POKE 53765,168:POKE 53760,254:POKE 53764,123
320 REM
330 ** MOVING PLAYERS
340 FOR I=1 TO X4:POKE 53251,I:NEXT I
350 FOR I=1 TO X3:POKE 53250,I:NEXT I
360 FOR I=1 TO X2:POKE 53249,I:NEXT I
370 FOR I=1 TO X1:POKE 53248,I:NEXT I
380 SOUND 0,0,0,0:FOR I=70 TO 0 STEP -1:SOUND 2,8,10,10:NEXT I
390 GOSUB 1160
400 K=1
410 REM
    
```

This game is rather like the well known Simon Says game. It uses good colour and sound, and provides a full range of difficulty levels.

As it runs in under 16K it is ideal for either Atari 400 or 800. Depending on the level of difficulty, between four and eight numbers are displayed in coloured rectangles.

These flash in a random sequence, together with a sound of characteristic pitch. The player then has to follow the sequence by pressing the right numeric keys. As the game goes on, the sequences get longer. A high score of number sequences remembered is kept.

As a program it is nicely written, and it uses machine code to speed up responses to input. The flashing numbers are produced by POKEing directly into screen RAM.

83

NEW: Speech & Music for ZX81 & Spectrum!
ZXM SOUND BOX

ZXS SPEECH SYNTHESISER

£29.95

£32.50



- 3 channel sound chip gives a huge range of possible sound effects. Programmable pitch, level, envelope and noise source.
- For the ZX81 or Spectrum - no adaptor needed.
- Just plug it in. Other peripherals or Ram Pack can be plugged into the ZXM.
- Built in amplifier and loudspeaker.
- Audio in/out socket, can be used to amplify the Spectrum 'beep'.
- 9-pin I/O socket can be used with cheap Atari/Commodore type joysticks.
- Comprehensive manual includes many example routines.

- For the ZX81 or Spectrum - no adaptor needed.
- Let your computer talk back!
- 'Allophone' synthesis gives an unlimited vocabulary.
- Active filtering for improved speech quality.
- Other peripherals or RAM Pack can be plugged into the ZXS.
- Output to normal audio amplifier or to our ZXM Sound Box.
- Manual gives full details on how to use the ZXS, with many examples.

And Don't Forget Our Books;

EXPLORING SPECTRUM BASIC: £4.95 The book of answers. Explains Spectrum BASIC programming techniques in more depth than was possible in the Sinclair manual, illustrated by over 50 full programs. 192 pages.

THE EXPLORERS GUIDE TO THE ZX81: £4.95 The book for the ZX81 enthusiast. Games, application and utility programs plus much useful information on machine code and hardware. "Immediate and lasting value" (PCW).

All prices include U.K. carriage and VAT where applicable. Overseas customers add £1.50 per item for surface mail.

TIMEDATA Ltd. 16 Hemmells, Laindon, Basildon, Essex. SS15 6ED Tel.: (0268) 418121

TIMEDATA

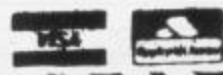

ORIC
SOFTWARE

TANSOFT

NEW



ORICMON

A complete machine code monitor including mnemonic assembler/disassembler, block move and verify, trace and slow-motion run and full cassette handling, plus manual. £15.00 inc VAT and 90p postage and packing 16k or 48k

ORIC MUNCH

Our best arcade game yet. Can you fight off the ghosts, eat the power pills and catch the elusive fruit. An exciting game that will keep you amused for hours. £7.95 inc VAT and 40p postage and packing 48k

MULTI-GAMES PACK 2

A set of new exciting and challenging games. Hangman, Moonlander, Substrike, Roadrace and 3D Link 4. £6.90 inc VAT and 40p postage and packing 48k

HOUSE OF DEATH

If you were baffled by Zodiac you will be terrified by House of Death. Can you discover the secret of the haunted house and escape with your life? £9.99 inc VAT and 40p postage and packing 48k

ORIC BASE

This is a database system used for the maintenance of personal and small business information. It is supplied on cassette with a comprehensive manual. A sophisticated query language is used to manipulate data and allow reports to be printed, data to be sorted or moved about and running totals to be kept. A Macro command facility allows the creation of application specific command strings which can be used easily by non-technical personnel. Requires a 48k machine. Price: £14.50 including VAT and 90p postage and packing.

ZODIAC

A traditional adventure game in which the player has to find the 12 cunningly hidden signs of the Zodiac which lead him to greater treasures. The player manipulates objects through simple sentences which the program can understand and can ask for his score at any time. A save game feature is also included. Requires a 48k machine. Price: £9.99 including VAT and 40p postage and packing.

ORIC-CHESS

Using high resolution graphics to display the chess board this package will play a challenging game of chess with five levels of skill. The computer looks ahead for its own moves plus its opponent's. The skill level dictates how far the computer looks ahead although at the expense of more time. All chess rules including Castling and En Passant are obeyed. Requires a 48k machine. Price: £9.99 including VAT and 40p postage and packing.

ORIC FORTH

This is a cassette-based implementation of FIG-FORTH, the language distributed by the Forth Interest Group in the United States. It has been extended to utilise the graphics and sound capabilities of the Oric. It is supplied with an editor and a full Forth assembler. A 96-page manual is included in the package. A demonstration music program is also supplied. Requires a 48k machine. Price: £15.00 including VAT and 90p postage and packing.

ORIC OWNER MAGAZINE. £10

Why should you subscribe to *ORIC OWNER*? Your Oric 1 is one of the most powerful low-cost computers on the market today. *Oric Owner* is the only magazine totally dedicated to the Oric and its supporting hardware and software. From issue to issue *Oric Owner* is able to bring you in-depth information on the Oric, advance news on the latest add-ons, superb programs to try and 'behind the scenes' interviews with the engineers who designed it. If you wish to keep ahead of the latest developments and news on the Oric then *Oric Owner* is essential. At only £10 for a year's subscription of 6 issues (£15 for overseas readers) can you afford to be without *Oric Owner*? **SUBSCRIBE TODAY!**

Calling all Software Writers.

If you can write top quality games, business or utility software we want to hear from you. Haven't got an Oric? Convince us of your capability and we will supply one!

Dealer Enquiries Welcome

Please send me	Quantity	Total
ORIC FORTH at £15.00		
ORIC BASE at £14.50		
ZODIAC at £ 9.99		
ORIC-CHESS at £ 9.99		
ORICMON at £15.00		
HOUSE OF DEATH at £ 9.99		
3D LINK 4 at £ 6.90		
ORIC MUNCH at £ 7.95		
ORIC OWNER MAGAZINE at £10.00		
82 GAMES	TOTAL	

● Please include money for postage. This amount varies with each item.

Please allow 28 days for delivery

All cheques payable to:
TANSOFT LTD
3 CLUB MEWS
ELY
CAMBS
CB7 4NW

Please send me latest price list

Name _____

Address _____

GAME *Flashback* MACHINE *Atari*

```

420 REM ** COMPUTER SEQUENCE DISPLAY
430 FOR J=1 TO K
440 POKE P(N(J)),N(N(J)):JJ=N(J):GOSUB 1190:POKE P(N(J)),N(N(J)):
GOSUB 1230:NEXT J
450 REM
460 REM **PLAYER SEQUENCE INPUT
470 OPEN #1,4,0:"*":POKE 764,255:FOR J=1 TO K
480 GET #1,X:IF X=49 OR X>L+48 THEN 480
490 Y=X-48:POKE P(Y),N(Y):JJ=N(J):GOSUB 1190:POKE P(Y),N(Y)
500 IF Y<>N(J) THEN CLOSE #1:GOTO 800:REM ** CHECK FOR PLAYER ERROR
510 NEXT J:CLOSE #1
520 REM
530 REM ** CHECK FOR END OF SEQUENCE
540 K=K+1:IF K>N THEN GOTO 560
550 GOSUB 1160:GOTO 430
560 LEV=LEV+1:IF LEV>6 THEN 880

570 L=LEV+2:N=LEV+3:GOSUB 60:
580 FOR I=1 TO L:POKE P(L),N(N(I)):FOR D=1 TO 10:SOUND 0,N(I),10,10:
NEXT D:SOUND 0,0,0,0
590 POKE P(L),N(N(I)):FOR D=1 TO 10:NEXT D:NEXT I:T=T+K-1:
FOR D=1 TO 50:NEXT D:GOTO 400
600 REM
610 REM ** INITIAL DISPLAY
620 GRAPHICS 3:POKE 710,146:POKE 712,146:POKE 752,1:LEV=1
630 BE=PEEK(550)+PEEK(561)*256+4
640 POSITION 1,1:?"FLASHBACK BY GWK CHEUNG"
650 POKE BE+2,7:POKE BE+3,6
660 POSITION 2,3:?"FOLLOW THE COMPUTER BY HITTING KEYS 1-8
(DIRECT INPUT)."
670 ?:"THE GAME WILL BEGIN WHEN 4 RECTANGLES ARE DISPLAYED ON
THE SCREEN."
680 ?:"THE GAME IS OVER WHEN THE PLAYER MAKES AN ERROR OR HAS
SUCCESSFULLY REPEATED THE SERIES OF "?
690 ?:"NUMBERS AT THE FINAL LEVEL."
700 ?:"SELECT INITIAL LEVEL:"
710 POSITION 1,16:?"LEVEL":POSITION 1,17:?"press start"
720 POKE BE+18,6:POKE BE+19,6:POKE BE+20,6
730 IF PEEK(53279)=5 THEN LEV=LEV+1:REM ** CHECK SELECT KEY
740 IF LEV>6 THEN LEV=1
750 POSITION 7,16:?"LEV:N=6*LEV
760 IF PEEK(53279)=6 THEN RETURN:REM ** CHECK START KEY
770 FOR D=1 TO 50:NEXT D:GOTO 730
780 REM
790 REM **SCORE DISPLAYS
800 GRAPHICS 18:POKE 53277,0
810 POSITION 5,3:?"#6:"AAHHHHH!" :GOSUB 1100
820 POSITION 2,7:?"#6:SCORE":T+K-1
830 POSITION 2,9:?"#6:"rats!"
840 GOSUB 1130:GOSUB 1160:FOR I=53248 TO 53251:POKE I,0:NEXT I
850 T=0:GOTO 150
860 REM
870 REM ** REMOVE PLAYERS
880 FOR I=0 TO X1:POKE 53248,X1-I:SOUND 0,X1-I,10,10:NEXT I
890 FOR I=0 TO X2:POKE 53249,X2-I:SOUND 0,X2-I,10,10:NEXT I
900 FOR I=0 TO X3:POKE 53250,X3-I:SOUND 0,X3-I,10,10:NEXT I
910 FOR I=0 TO X4:POKE 53251,X4-I:SOUND 0,X4-I,10,10:NEXT I
920 REM
930 REM ** CONGRATULATE PLAYER
940 GRAPHICS 18:POKE 710,146:POKE 712,146:POKE 53277,0
950 POSITION 2,5:?"#6:"WELL DONE!!"
960 POSITION 2,7:?"#6:SCORE":T+K-1
970 GOSUB 1130:GOSUB 1160:GOTO 150
980 REM
990 REM **P/M GRAPHICS SUBROUTINE FOR 4 RECTANGLES
1000 X1=67:X2=100:X3=133:X4=166
1010 A6 = PEEK(106)-16:POKE 54279,A6:PM3=256+A6
1020 POKE 623,4:FOR I=53256 TO 53259:POKE I,3:NEXT I
1030 POKE 559,46:POKE 53277,3
1040 FOR I=53248 TO 53251:POKE I,0:NEXT I
1050 D=USR(ADR(P3),PMB+512):D=USR(ADR(P3),PMB+768)
1060 POKE 704,98:POKE 705,22:POKE 706,182:POKE 707,70:REM **COLOURS
OF RECTANGLES
1070 D=USR(ADR(Z3),PMB+542):D=USR(ADR(Z3),PMB+670):D=USR(ADR(Z3),
PMB+798):D=USR(ADR(Z3),PMB+926):RETURN
1080 REM
1090 REM **ERROR SOUND EFFECTS
1100 FOR I=70 TO 196:SOUND 0,I,12,15:POKE 712,I:POKE 710,I:
NEXT I:SOUND 0,0,0,0:RETURN
1110 REM
1120 REM **UPDATE HIGHSCORE
1130 IF T+K-1>HS THEN HS=T+K-1:RETURN
1140 REM
1150 REM **DELAY
1160 FOR D=1 TO 500:NEXT D:RETURN
1170 REM
1180 REM **MUSICAL NOTES
1190 FOR D=1 TO 16:SOUND 0,NT(CJJ),10,15:NEXT D:SOUND 0,0,0,0:RETURN
1200 FOR I=1 TO 6:SOUND 0,NT(CJJ),10,15:NEXT I:RETURN
1210 REM
1220 REM **FLASH DISPLAYS
1230 FOR D=1 TO 10:NEXT D:RETURN

```

COMPETITION-PRO JOYSTICK

PRECISION GAME CONTROL!



Outstanding Features

• Self centring stick • Super Strong nylon and steel construction, built to last. • A total of 8 directions plus 2 large fire buttons. • Arcade proven moulded leaf switches ensure incredible reliability. • For ZX Spectrum complete with stylish interface which simply plugs into the Spectrum expansion port (with or without printer) ONLY £24.99 inc. VAT. • Full range of joystick compatible software for Spectrum Available from W H Smith, Boots and leading computer shops or direct from us. • For VIC 20, Commodore 64, Atari 400 and Atari 800 only £14.50 inc. VAT.

Now Available

Conversion Tape I Only £4.95 - Converts seven leading arcade games to run with the Kempston Joystick: Horace Goes Skiing - Sinclair, Hungry Horace - Sinclair, Flight Simulation - Sinclair, Arcadia - Imagine, Penetrator - Melbourne House, Spectres - Bug Byte, Space Zombies - Mikrogen.

Also

Conversion Tape II Only £4.95 - Converts: Orbiter - Silversoft, Escape - New Gen, Tanx - DK Tronics, Centipede - DK Tronics, Spectral Invaders - Bug Byte, Cruising On Broadway - Sunshine, Frezzy - Quicksilva (Early Versions).

SOLE UK DISTRIBUTOR

KEMPSTON

MICRO ELECTRONICS

Dept 180a Bedford Road, Kempston, Bedford MK42 8BL

I wish to order the following:

Hardware

- Spectrum Joystick inc. interface £24.99
- Spectrum Joystick interface £15.00
- VIC 20, Commodore 64, Atari 400/800 Joystick £14.50

Spectrum Software

- | | | |
|---|-------------------|--------|
| <input type="checkbox"/> Astro Blaster | 16K Quicksilva | £4.95 |
| <input type="checkbox"/> Blind Alley | 16K Sunshine | £4.95 |
| <input type="checkbox"/> Cosmic Guerilla | 16K Crystal | £5.95 |
| <input type="checkbox"/> Cosmos | 16K Abbex | £5.95 |
| <input type="checkbox"/> Cyber Rats | 16K Silversoft | £5.95 |
| <input type="checkbox"/> ETX | 16K Abbex | £5.95 |
| <input type="checkbox"/> Frezzy | 16K Quicksilva | £4.95 |
| <input type="checkbox"/> Frogger | 16K DJL | £5.95 |
| <input type="checkbox"/> Galaxians | 16K Artic | £4.95 |
| <input type="checkbox"/> Gulpman | 16K Campbell Sys. | £4.95 |
| <input type="checkbox"/> Jet Pac | 16K Ultimate | £5.95 |
| <input type="checkbox"/> Joust | 16K Softek | £5.95 |
| <input type="checkbox"/> Knot in 3D | 48K New Gen | £5.95 |
| <input type="checkbox"/> Mazeman | 16K Abersoft | £5.95 |
| <input type="checkbox"/> Meteoroids | 16K Softek | £4.95 |
| <input type="checkbox"/> Night Flite | 16K Hewson Cons | £5.95 |
| <input type="checkbox"/> PSSST | 16K Ultimate | £5.95 |
| <input type="checkbox"/> 3D Tunnel | 16/48K New Gen | £5.95 |
| <input type="checkbox"/> Time Gate | 48K Quicksilva | £6.95 |
| <input type="checkbox"/> Slippery Sid | 16K Silversoft | £5.95 |
| <input type="checkbox"/> Spookyman | 16K Abbex | £4.95 |
| <input type="checkbox"/> Conversion Tape I | Kempsoft | £4.95 |
| <input type="checkbox"/> Conversion Tape II | Kempsoft | £4.95 |
| <input type="checkbox"/> Spectrum Joystick interface only | | £15.00 |

Please tick appropriate boxes.

Prices include P&P and VAT. Overseas prices add £4.00 P&P Total £

Cheques/Postal Orders should be made payable to Kempston (Micro) Electronics Ltd.

Name _____ Signature _____

Address _____

Please debit my Access/Visa* Account No. * Delete as applicable



CHAMPIONS!

The smash hit FOOTBALL GAME

for the
DRAGON 32, SPECTRUM 48,
BBC B and ZX81 16k

available on cassette for
£6.95 (ZX81 £5.45)
by return of 1st class
post from

PEAKSOFT

7 HAWTHORN CRESCENT
BURTON-ON-TRENT
(0283) 44904

COULD YOU BE THE NEXT BRIAN CLOUGH?

Take your team from the 4th Division to the European Cup! Features 4 divisions, promotion, relegation, transfers, injuries, suspensions, weekly results and league tables, reserve team, crowd trouble, and all the fun, drama and frustration of managing a league club.

If you don't give two hoots for football, you'll be hooked. If you're a fan, you'll be playing all night! One of the most entertaining games currently available — it's the one that we play!

LIONHEART (Dragon only) £5.45 — Unique, two-part romp. Arcade-style action as you assemble your army, pursued by the ruthless Prince John, switches to colourful graphics adventure as you land in the Holy Land to mount your Crusade against the Sultan Saladin.

DEATH'S HEAD HOLE (Dragon/BBC B) £5.45 — Our highly-acclaimed adventure. Lead a mission of mercy into a Mendips pothole. When you discover who's down there, you'll wish you'd stayed at home! "Breaks new ground in home computer simulations" — Dragon's Teeth.

DON'T PANIC! (Dragon only) £3.45 — Two classic adventures at an incredible price, to launch our new Bargain Bytes series. Features Towers of Death and The Ice Kingdom. Villains and hazards galore.

HANG IT! (Dragon only) £5.45 — 1,000 (yes, 1,000!) posers on British place names in this family word game. Set your own problems option.

OCTOPUSSY (ZX81 16K only) £3.45 — Rescue the treasure from the boat... but look out for Octopussy's deadly tentacles!

All prices include post and packing. Clip the coupon, or simply note your name, address, computer and programs required on the back of your cheque.

Computer..... Please send me

Name

Address

GAME Aircraft Lander
MACHINE Video Genie

**VIDEO GENIE
 AIRCRAFT
 LANDER**

BY P BAILEY

```

1 REM *** AIRCRAFT LANDING SIMULATOR ***
2 REM *** BY P.E BAILEY ***
3 REM *** DATE 3/11/82 ***
10 GOTO 9000
90 REM *** UTILITY SUBROUTINES ***
100 REM *** SHORT DELAY ***
110 FOR J = 1 TO 50 : NEXT J : RETURN
200 REM *** LONG DELAY ***
210 FOR J = 1 TO 500 : NEXT J : RETURN
300 REM *** END OF PAGE ***
310 PRINT : PRINT "PRESS <NEW LINE> TO CONTINUE"
320 X$ = "" : X$ = INKEY$ : IF X$ = "" THEN 320
330 IF ASC(X$) <= 15 THEN 320
340 CLS
350 RETURN
400 REM *** CALCULATE COMPONENTS OF VELOCITY ***
410 RA = AD * C1
420 VX = AS * SIN(RA)
430 VY = AS * COS(RA)
440 RETURN
1000 REM *** APPROACH TO AIRFIELD
1010 GOSUB 5000
1020 GOSUB 2000
1030 IF PZ <= 3 THEN GOTO 1200
1040 GOSUB 4000
1050 GOSUB 5000
1060 GOTO 1010
1200 REM *** AFTER TOUCHDOWN ***
1210 GOSUB 3000
1220 IF LF = 1 THEN 1400
1230 PRINT : PRINT "TOUCHDOWN"
1240 GOSUB 5000
1250 GOSUB 6000
1260 GOSUB 4000
1270 IF LF = 2 THEN 1600
1280 IF LF = 3 THEN 1800
1290 GOTO 1250
1400 REM *** FATAL CRASH ***
1410 CLS
1420 X$ = "" : X$ = INKEY$ : IF X$ = "" THEN 1400
1430 PRINT : PRINT "FATAL CRASH"
1440 GOSUB 110
1450 PRINT : PRINT "STRINGS(12,32)"
1460 GOSUB 110
1470 GOTO 1420
    
```

Here's a realistic and challenging simulation for 16K Video Genie owners. The idea is that you are piloting an aircraft down a runway, allowing for crosswinds. The aim is, of course, to land safely.

It can be a bit unnerving to play as the responses to your controls are intentionally delayed. Small corrections or small cross-winds can cause dramatic effects. The instructions contained in the program are clear and well set out, but it may be worth making a separate note of these as they are rather a lot to remember in one go.

You can select the strength of wind against which you wish to fly. A zero cross-wind will make the landing easier as you will not have to use the 'roll' controls. Apart from roll, you control pitch and throttle. You can land safely only in certain control limits. Once you have landed you have to straighten up the aircraft and apply the brakes - if you run out of runway you crash!



SPECIAL PRICE
ORIC 48K
£149.95 (inc VAT)
 POST FREE IN UK
LIMITED OFFER

ORIC SOFTWARE
 Dept PCG(1), 118 Worcester Rd, Malvern, Worcs, WR14 1SS
SPECIALIST SUPPLIERS OF ORIC SOFTWARE

AVAILABLE NOW
SOFTWARE CATALOGUE
FREE WITH EVERY PURCHASE

OR send £1.00 which will be deducted from your first order

This is a Comprehensive catalogue of software just for the ORIC computer, with descriptions and titles for all the software we have available. Some of the titles are listed here.



£149.00 inc VAT

- Uses Easily Replaceable Ink Cartridges
 - Includes Serial and Parallel Interfaces
- Creates beautiful graphics in red, blue, green and black, plus prints alphanumerics. Built-in commands simplify drawing and plotting. Text mode prints 40 or 80 characters per line at 12 characters/sec. Software controls additional character sizes and rotation.

85

Postage & packing 50p (1 to 7 cassettes)

AIRLINE	48K	£7.95
GRAIL	48K	£6.95
ZODIAC	48K	£9.95
JOGGER	48K	£6.95
BIORHYTHMS	48K	£5.95
FLIGHT	48K	£7.95
SYNTHESIZER	48K	£7.95
MULTIGAMES - 5 Games	48K	£7.95
MORIA	48K	£6.95
CHESS	48K	£9.95
DALLAS	48K	£7.95
ORIC BASE - Database	48K	£14.95
FORTH	48K	£17.95
WORD PROCESSOR	48K	£17.95
ORIC MON	48K	£14.95
ORIC MUNCH	48K	£7.95
HOUSE OF DEATH	48K	£9.99

(Dealership enquiries welcome - apply on letterhead)

Return to: **ORIC SOFTWARE**, Dept PCG(1), 118 Worcester Rd, Malvern, Worcs, WR14 1SS. Tel: Malvern (06845) 62467

I have a 16K Oric _____
 48K Oric _____

My Software interests are:
 Home - Business - _____
 Games - Education - _____
 Other (Please specify) _____

Mr/Mrs/Miss/Ms _____
 Address _____
 Postcode _____
 Cheque enclosed _____
 Please debit my Access/Visa, AMex, Dclub - with £ _____
 No _____

SOFTWARE WRITERS: Lump sum or royalty payments.
 Send tapes & details. (Tapes not returned unless return postage is included.)

GAME *Aircraft Lander*
MACHINE *Video Genie*

85

```

1480 CLS :
      PRINT "THE FLIGHT RECORDER HAS BEEN RECOVERED"
1490 PRINT "THE FINAL FLIGHT DETAILS WERE AS FOLLOWS"
1500 GOTO 9000
1600 REM *** OFF RUNWAY AFTER GOOD LANDING ***
1610 CLS
1620 IF PY > 0 THEN
      PRINT "YOU HAVE GONE OFF THE END OF THE RUNWAY."
      PRINT "TRY USING YOUR BRAKES NEXT TIME."
1630 IF ABS(PX) > WR THEN
      PRINT "YOU ARE OFF THE SIDE OF THE RUNWAY."
      PRINT "ISN'T IT WIDE ENOUGH FOR YOU?"
1640 IF AS <= 10 THEN
      PRINT "LUCKELY THERE IS ONLY MINOR DAMAGE AT THIS SPEED"
1650 IF AS > 10 AND AS <= 25 THEN
      PRINT "SERIOUS DAMAGE TO YOUR AIRCRAFT, BUT YOU SURVIVE"
      PRINT "TO SCAPE YOUR PASSENGERS TO DEATH AGAIN"
1660 IF AS > 25 THEN
      PRINT "DISASTER - FATAL CRASH"
1670 PRINT
1680 PRINT "DETAILS OF THE FLIGHT WHEN YOU LEFT THE RUNWAY:--"
1690 GOTO 9000
1800 REM *** GOOD LANDING ***
1810 PRINT "CONGRATULATIONS CAPTAIN - A SAFE LANDING"
1820 GOTO 9000
2000 REM *** UPDATE POSITION AND SPEED IN THE AIR ***
2010 PX = PX + GX
2020 PY = PY + GY
2030 PK = PX + GK
2040 PT = PY + KC
2050 PL = PL + BC
2060 AS = AS + Z + SGN( TC ) - AS
2070 AD = AD + RL
2080 VZ = 1 + CTC - 5 + AS + SGN( PT + CL )
2090 GOSUB 400
2100 GZ = VZ
2110 GY = VY + MY
2120 GK = VX + MX
2130 CD = AENE VX/VY + CZ
2140 RETURN
3000 REM *** CHECK FOR CRASH ***
3010 IF ABS(PL) > FT
      OR PT > IF OR PT < 0
      OR ABS(AD) > FT
      OR AS < 45 OR AS > 55
      THEN LF = 1 :
      PRINT "CRASH ON LANDING"
3020 IF ABS(PX) > WR OR PY > 0 OR PY < -LP
      THEN LF = 1 :
      PRINT "OFF RUNWAY"
3030 GOSUB 200
3040 RETURN
4000 REM *** UPDATE DISPLAY ***
4010 HT = -PY - 10 + PX - WR : RD = -PX - WR
4020 HD = HT + 1 : IF HD < -PY THEN HD = -PY
4030 IF HD < 5000 THEN HD = 5000
4040 FOR I = 0 TO 4
4050 YD = -PY - 1 + 500
4060 C(I,1) = LD : C(I,5) = RD
4070 C(I,2) = YD : C(I,4) = YD
4080 C(I,3) = HT : C(I,6) = HT
4090 NEXT I
4100 C(10,1) = -PX : C(10,2) = -PY : C(10,3) = HT
4110 C(11,1) = -PX : C(11,2) = -PY - LH : C(11,3) = HT
4120 A1 = 64/WR : A2 = 64.5 : A3 = 17.5 : A4 = 51
4130 FOR I = 0 TO 11
4140 AD = C(I,1) - 233/HD
4150 R(I,1) = INT(C(I,1) * AD * A1 * A2)
4160 R(I,2) = INT(C(I,2) * AD * A3)
4170 NEXT I
4180 ON ERROR GOTO 4250
4190 FOR I = 500 TO 896 STEP 64
4192 PRINT "CHANGES"
4194 NEXT I
4196 PRINT "SPRINGS(63,128)"
4200 FOR I = 0 TO 11
4210 SET ERC(I,1) = R(I,2)
4220 NEXT I
4230 ON ERROR GOTO 0
4240 GOTO 4260
4250 RESUME NEXT
4260 PRINT "INTEGRALS"
      TAB(0) : INT(CD+C5)
      TAB(1) : INT(CD+C5)
      TAB(2) : INT(CD+C5)
      TAB(3) : INT(CD+C5)
      TAB(4) : INT(CD+C5)
      TAB(5) : INT(CD+C5)
      TAB(6) : INT(CD+C5)
      TAB(7) : INT(CD+C5)
      TAB(8) : INT(CD+C5)
      TAB(9) : INT(CD+C5)
4270 RETURN
5000 REM *** CHECK CONTROLS ***
5010 XS = ""
5020 XE = INKEYS
5030 IF XS = "" THEN RETURN
5040 IF ASC(XS) > 47 AND ASC(XS) < 58 THEN TC = VAL(XS) : RETURN
5050 IF XS = "F" THEN BC = -1
5060 IF XS = "G" THEN BC = 0
5070 IF XS = "H" THEN BC = 1
5080 IF XS = "M" THEN NC = 1
5090 IF XS = "K" THEN NC = 0
5100 IF XS = "D" THEN NC = -1
5110 RETURN
5500 REM *** CONTROLS AFTER LANDING ***
5510 XS = ""
5520 XE = INKEYS
5530 IF XS = "" THEN RETURN
5540 IF XS = "P" THEN RC = 1
5550 IF XS = "E" THEN RC = -1
5560 IF XS = "C" THEN RC = 0
5570 IF XS = "B" THEN FD = 2
5580 RETURN
6000 REM *** AFTER TOUCHDOWN ***
6010 PT = 0 : RL = 0 : PZ = 0
6020 GOSUB 500
6030 PX = PX + VX
6040 PY = PY + VY
6050 IF ABS(PX) > WR OR PY > 0 THEN LF = 2
6060 AD = AD + 40 + 40 + (SGN(AD) * SGN(PT))
6070 AS = AS - FD : IF AS <= 0 THEN LF = 1
6080 GOSUB 400
6090 RETURN
9000 REM *** INITIALISATION ***
9010 CLEAR 100 : DEFINT I-K
9020 DIM C(11,6) : F(11,2)
9030 CLS : PRINT TAB(20) "AIRCRAFT LANDING SIMULATOR" : PRINT
9040 INPUT "DO YOU REQUIRE INSTRUCTIONS (Y/N)?" : XS
9050 PRINT
9060 IF XS = "N" THEN 9290 ELSE IF XS = "Y" THEN 8000
9070 INPUT "PLEASE TYPE Y OR N?" : XS : GOTO 8060
9080 CLS
9090 PRINT
      "IT IS DARK AND RAINING. YOU ARE APPROACHING THE AIRPORT WITH
      300 PASSENGERS ON BOARD AND YOUR CO-PILOT HAS JUST BECOME
  
```

D-I-Y
86

SPECIAL OFFER!
Deduct £1 per cassette or disc when ordering 2 or more.

THE BEST BBC MICRO SOFTWARE

PRODUCED BY AN INDEPENDENT SOFTWARE HOUSE

— TOP QUALITY MACHINE-CODE PROGRAMS —

BBC



CENTIPEDE (32K) £7.95 Cassette

Incredible arcade type game featuring mushrooms, snails, flies, spiders and the centipedes of course. Excellent graphics and sound. 6 skill levels, hi-score, rankings, bonuses, and increasing difficulty as the spiders become more active and the number of mushrooms increases.

"Visually this game compares well with the arcade version, being colourful and clear."

... YOUR COMPUTER



FROGGER (32K) £7.95 Cassette

Not just another version of Frogger... this is the proper high-quality version that you've been waiting for. Graphically brilliant, with gaping-mouthed crocodiles, diving turtles, and frogs that flex their legs as they jump along. Increasing difficulty, hi-score, responsive controls, sound effects, flies and bonus frogs.

●●● NEW RELEASE ●●●



ROAD RUNNER (32K) £7.95 Cassette

The only full feature machine-code version of the arcade game available for the B.B.C. micro. Features include: scrolling screen, radar display, checkpoint flags, fuel gauge, smoke screens, 6 skill levels, rankings, increasing difficulty, and sound effects.

Suitable for use with keyboard or joysticks.

●●● NEW RELEASE ●●●



ALIEN DROPOUT (32K) £7.95 Cassette

Based upon the arcade game of ZYGON, but our version improves upon the original arcade game itself. You have to shoot the aliens out of their "boxes" before the "boxes" fill up. Once full, the aliens fly down relentlessly, exploding as they hit the ground. Suitable for use with keyboard or joysticks.

"Do not be fooled by their placid appearance - these moths are out to get more than the clothes in your wardrobe." ... YOUR COMPUTER



SPACE FIGHTER (32K) £7.95 Cassette

Arcade-style game based upon features from DEFENDER and SCRAMBLE. 5 types of menacing alien fire at you and may attempt to ram you. Separate attack phases, fuel dumps, repeating laser cannon, asteroids, smart bombs, hi-score, rankings, 6 skill levels, sound effects.

"A thoroughly enjoyable program, well worth the money..."

... HOME COMPUTING WEEKLY.



GALAXIANS (32K) £7.95 Cassette

Fast action version of the popular arcade game. 4 types of Galaxian (in 3 initial screen formations) swoop down individually or in groups of two or three. 6 skill levels, high score, rankings, bonus laser bases and increasing difficulty. Superb sound effects and graphics.

"Both... are well-produced, with colourful graphics, responsive controls and the usual bunch of extra-terrestrials." ... YOUR COMPUTER



INVADERS (32K) £7.95 Cassette

Superb version of the old classic arcade game, including a few extras. 48 marching invaders drop bombs that erode your defences, and two types of spaceship fly over releasing large bombs that penetrate through your defences. Increasing difficulty, high score, superb graphics and sound.



FRUIT MACHINE (32K) £7.95 Cassette

Probably the best fruit machine implementation on the market. This program has it all... HOLD, NUDGE, GAMBLE, spinning reels, realistic fruits and sound effects, multiple winning lines. This is THE fruit machine program to buy.

"The graphics are very good and with a little imagination you might be able to convince yourself you are in Las Vegas." ... YOUR COMPUTER

DEALERS

DEALERS

DEALERS

DEALERS

DEALERS

All our programs are available at all good dealers including:-

- ELTEC COMPUTERS, 217, Manningham Lane, Bradford.
- BUCON LIMITED, 18 Mansel Street, Swansea.
- WEST COAST PERSONAL COMPUTERS, 47 Kyle Street, Ayr.
- BYTEWARE LIMITED, Unit 25, Handyside Arcade, Newcastle.
- MICROSTYLE, 29 Belvedere, Lansdown Road, Bath.

- MICROSTYLE, 47 Cheap Street, Newbury, Berks.
- SIR COMPUTERS LTD., 91 Whitechurch Road, Cardiff.
- ELECTRONEQUIP, 36-38 West Steet, Fareham, Hants.
- MICRO MANAGEMENT, 32 Princes Street, Ipswich.
- 3D COMPUTERS, 230 Tolworth Rise South, Tolworth, Surbiton, Surrey.

+ MORE THAN 30 OTHER DEALERS IN THE U.K. AND OVERSEAS.

WE PAY 25% ROYALTIES FOR HIGH QUALITY PROGRAMS



SUPERIOR SOFTWARE

Dept. YC8,
69 Leeds Road, Bramhope, Leeds.
Tel. 0532-842714

DISC SOFTWARE AVAILABLE NOW

All our programs are ready for despatch on 5 1/4" discs at £11.95 each.

WE GUARANTEE THAT:

- (1) All our software runs correctly on all current operating systems and BASIC ROMs.
- (2) All our software is available before we advertise.
- (3) All our software is despatched within 48 hours by first class post.
- (4) In the unlikely event that any of our software fails to load, return your cassette or disc to us and we will immediately send a replacement.

LOOK FOR THE
ULTIMATE
SIGN FOR THE
ULTIMATE GAMES



**PSSST for 16 or 48K
SPECTRUM**

Little vermin, leave my planet alone, Oyl sucking the life from my Thyrgodian Megga Chrisanthoodi, making her shrink, wilt and die. I'll soon put a stop to their little game, quick Spray-O-Mustn't die, mustn't die, there! Take that and that. I'll hold you little, little... Quickly, get the super space slug spray, and then the leech laser. Quick, Quick. They breed so fast, can't hold them back for long. Hurry!... Hurry!... Arrgggg!...
PSSST... The ULTIMATE Challenge. sound effects, amazing smooth high resolution visual graphics, and that totally new addictive concept and all those features you come to expect from the ULTIMATE GAME people.
PSSST... Go grow yourself a REAL game. Now you know why 'ULTIMATE PLAY THE GAME'.

JET PAC for 16 or 48K SPECTRUM

The 'Acme Interstellar Transport Company' is delivering Spaceship kits to various planets throughout the Galaxy, and as chief test pilot, all you have to do is assemble the Rockets and thrust on to your next destination. You might just Bull as you don't often get the chance of a free trip across the Galaxy, and space travel is, oh, so expensive, now's your chance to get rich! You might just as well stop off on several planets on your journey, collect the odd sack of precious gems, elements or gold, and take them back with you. Upon landing, you will find yourself equipped with the very latest Hydrovac Phasers, to blast any nasty, mean, little aliens who might object to your visit. And my! do those aliens get upset, when you collect all of their valuables, and sneak off, without so much as a by-your-leave.
JET PAC Arcade standard, 100% machine code, incredible sound effects, amazing smooth high resolution visual graphics, the totally new addictive concept and all those extra features you expect from the ULTIMATE GAME people.
Now you know why 'ULTIMATE PLAY THE GAME'.
JET PAC The game to play all the way.
Design: 'ULTIMATE PLAY THE GAME'



Dealership enquiries welcome, phone (0530) 411485



ULTIMATE
These games should be available from W. H. SMITH, JOHN MENZIES, BOOTS, other larger department stores and all major software retailers, alternatively send the coupon to ULTIMATE PLAY THE GAME for immediate dispatch. Subject to availability, you should receive your order within 3 days of posting.
£5.50 each including VAT, first class postage and packing

ULTIMATE PLAY THE GAME is a trade name of Ashby Computers & Graphics Ltd.

Post this coupon now, to **ULTIMATE PLAY THE GAME**, The Green, Ashby de la Zouch, Leicestershire LE6 5JU

Please send me the following:

JET PAC **PSSST**

KEMPSTON joystick information

Enclose PO/cheque for £

Name

Address

GAME Aircraft Lander
MACHINE Video Genie

86

```

INCONSCIOUS* SO YOU MUST LAND THE AIRCRAFT ALONE. TO BE HONEST"
8100 PRINT
*HE WAS NOT DOING A GREAT JOB BEFORE HE PASSED OUT.
YOU ARE IN LEVEL FLIGHT AT AN ALTITUDE OF 1000M BUT ONLY 20 KM
FROM THE FAR END OF THE RUNWAY. YOUR AIRCRAFT IS POINTING IN"
8110 PRINT
*THE CORRECT DIRECTION BUT ANY CROSSWIND WILL CAUSE A DEVIATION
FROM THIS PATH."
8120 GOSUB 510
8130 PRINT
*YOU MUST LAND WITH AN AIRSPEED OF ABOUT 50 M/S WITH NO
APPRECIABLE ROLL OR PITCH. ROLL MUST BE LESS THAN 3 DEGREES
AND PITCH BETWEEN 0 AND 5 DEGREES. SINCE THE RUNWAY IS 2000 M"
8140 PRINT
*LONG THE DISTANCE INDICATOR MUST SHOW LESS THAN THIS FIGURE ON
TOUCHDOWN. SIMILARLY THE RUNWAY IS 100 M WIDE SO THAT IF THE
DEVIATION IS GREATER THAN 50 M ON TOUCHDOWN YOU WILL MISS THE
RUNWAY."
8150 PRINT:PRINT
*AFTER TOUCHDOWN YOU MUST USE THE RUDDER TO CORRECT THE
DIRECTION OF TRAVEL AND THE BRAKES TO STOP BEFORE YOU REACH
THE END OF THE RUNWAY (THIS IS INDICATED BY A DISTANCE READING)"
8160 PRINT
*OF COURSE, IF YOU FAIL TO STOP OR TO CORRECT YOUR DIRECTION (WHICH
MAY NOT BE 0 WHEN LANDING IN A CROSSWIND) YOU WILL CRASH."
8170 PRINT : GOSUB 310
8180 PRINT
*YOU CAN SEE THE RUNWAY LIGHTS AHEAD AND IN THE DISTANCE THE
LIGHTS OF THE CITY YOU HOPE TO AVOID.
FOUR INSTRUMENTS GIVE THE FOLLOWING INFORMATION:
=
8190 PRINT
*AIRSPEED SPEED IN M/S
BEARING DIRECTION IN WHICH AIRCRAFT IS POINTING. 0 IS
STRAIGHT AHEAD. POSITIVE VALUES TO THE RIGHT
PITCH POSITIVE VALUES WHEN THE AIRCRAFT'S NOSE IS UP"
8200 PRINT
*ROLL POSITIVE VALUES CLOCKWISE. ROLL CAUSES BANKING WHICH
CHANGES THE AIRCRAFT'S BEARING.
ALT HEIGHT ABOVE THE GROUND IN M.
DISTANCE FROM FAR END OF THE RUNWAY IN M
DEV SIDEWAYS DEVIATION FROM CENTRE OF RUNWAY"
8210 GOSUB 310
8220 PRINT
*IN FLIGHT YOU HAVE THE FOLLOWING CONTROLS:
=
F ROLL TO LEFT
G MAINTAIN ROLL AT THIS LEVEL
H ROLL TO RIGHT
M NOSE UP (INCREASE PITCH)
K MAINTAIN PITCH AT THIS LEVEL
D NOSE DOWN (DECREASE PITCH)
=
8250 PRINT
*0-9 THROTTLE CONTROL
EACH SETTING HAS A TERMINAL VALUE OF SPEED WHICH IS
REACHED EVENTUALLY. E.G. 5 = 150 M/S, 2 = 50 M/S.
LANDING IS USUALLY ACHIEVED ON SETTING 2."
8240 GOSUB 310
8250 PRINT
*AFTER TOUCHDOWN ONLY THE FOLLOWING HAVE EFFECT:
=
E RUDDER LEFT
R RUDDER RIGHT
B APPLY BRAKES
=
N.B. ALL CONTROLS HAVE A DELAYED EFFECT ON A LARGE AIRCRAFT."
8260 PRINT
* IN GENERAL THEY HAVE AN EFFECT ON THE SECOND DISPLAY AFTER
PRESSING A KEY.
=
GOOD LUCK.
=
8270 INPUT "DO YOU WANT TO SEE THESE INSTRUCTIONS AGAIN?"X1
8280 GOTO 8060
8290 PI = 3.14159
8300 CL = PI / 180 : C2 = 100 / PI
8310 CS = .5
8320 LF = 0 : *LANDING FLAG
8330 PZ = 1000 : *ALTITUDE
8340 PY = -2E4 : *DISTANCE FROM AIRFIELD (TO END OF RUNWAY)
8350 PX = 0 : *LATERAL DEVIATION FROM GLIDE PATH
8360 RL = 0 : *ROLL
8370 PT = 0 : *PITCH
8380 AS = 150 : *AIRSPEED
8390 AD = 0 : *AIR DIRECTION
8400 GOSUB 400
8410 CLS
8420 PRINT
*PLEASE SELECT WINDSPEED AND DIRECTION. A DIRECTION OF 0 MEANS
THAT THE WIND IS BLOWING STRAIGHT AT YOU AND THIS GIVES THE
EASIEST LANDING SINCE YOU DO NOT NEED TO ALTER ROLL OR BEARING."
8430 PRINT
*THE DIRECTION SHOULD BE BETWEEN -90 (FROM THE LEFT) AND +90
(FROM THE RIGHT). A WIND SPEED OF 5 IS A LIGHT BREEZE* A SPEED
OF 30 IS A GALE.
=
8440 INPUT "WIND SPEED (M/S)"X2
8450 INPUT "WIND DIRECTION (DEG)"Y1
8460 MY = "X0 * COS(X1 * C1)"
8470 MX = "X0 * SIN(X1 * C1)"
8480 GZ = Y2 : GY = Y1 + MY : GX = VX + MX
8490 TC = 5 : *THROTTLE CONTROL
8500 BC = 0 : *BANKING CONTROL
8510 NC = 0 : *NOSE UP/DOWN CONTROL
8520 RC = 0 : *RUDDER CONTROL
8530 FOR I = 0 TO 9 : READ TSC(I) : NEXT I
8540 DATA 0,25,50,75,100,150,200,250,275,300
8550 TT = 20 : *YAW TOLERANCE
8560 RT = 3 : *ROLL TOLERANCE
8570 TP = 5 : *PITCH TOLERANCE
8580 LR = 2000 : *RUNWAY LENGTH
8590 WR = 50 : *RUNWAY WIDTH
8600 WD = 5E4 : *DISTANCE TO HORIZON
8610 CLS
8620 PRINT 3 3:
*AIRSPEED BEARING PITCH ROLL ALT DIST DEV"
8630 PRINT 3 3:
*... ..
8640 GOTO 1000
8800 REM *** FINAL DETAILS ***
9010 PRINT
9020 PRINT "SPEED = "I ASJ "M/S"
9030 PRINT "DIRECTION = "I AD: "DEG"
9040 PRINT "DISTANCE FROM END OF RUNWAY = "I ABS(PY) "M"
9050 PRINT "DISTANCE FROM CENTER OF RUNWAY = "I ABS(PX) "M"
9060 PRINT "PITCH = "I PT: "DEG"
9070 PRINT "ROLL = "I RL: "DEG"
9080 XB = "" : X8 = INKEY$ : IF X8 = "" THEN 9080
9090 END

```

LLAMASOFT!!

MORE THAN JUST A PRETTY PACKET!

VIC 20



ABDUCTOR ★

A classic new space game! ZAP the swirling alien hordes before they ram you - and abduct your humanoids! Survive the assault for long enough and you'll get an extra stage on your spaceship with double firepower! Awesome unexpanded VIC Action.

£6.00 - 50p P&P



GRIDRUNNER ★

Finally true arcade quality on the unexpanded VIC! Shoot down the segmented DROIDS invading the grid. Beware of the pods and zappers! The awesome speed, sound, and graphics gives you the best bang available for unexpanded VIC.

£5.00 - 50p P&P



ANDES ATTACK (8K) ★

Your spacecraft must attack the descending aliens and frustrate their evil intent. Fly your Ramjet fighter over the Andes mountain range and protect your llamas from kidnap by hostile UFO's. Features 5 kinds of UFO, controls include up, down, reverse, fire, thrust and smart bomb. Entirely in machine code. Requires 8K expansion and joystick.

£8.00 - 50p P&P



TRAXX (8K + EXPANSION) ★

This is VIC 20 cross breed between the now famed 'Pacman' and the game 'Quix'. All in machine code, fast and fun with joystick controls, uses Hi-Res colour graphics. 8K or larger expansion needed.

£6.00 - 50p P&P
complete with instructions



VIC 20



BLITZKRIEG ★

As seen at the Commodore show and reviewed by the Daily Telegraph. Fly your Vulcan Bomber over the enemy city, destroy the buildings. 25 levels of play, uses Hi-Res colour graphics and plays Rule Britannia between waves.

£4.95 complete with instructions



LASER ZONE ★

Experience Laser Zone - an utterly NEW totally ORIGINAL masterpiece of Video games design. Learn to control two spaceships at once. Feel the EXHILARATION as, after 10 hours of practise, you control the two ships so that they function as a smooth, co-operative team! Feel the raw POWER as you lunge for the electro button and BLAST your enemies into expanding clouds of SPACE JUNK!! Feel the humiliation as a carelessly aimed BLAST slams into the side of your last remaining ship!! Only

£6.00 - 50p P&P

COMMODORE 64



ATTACK of the MUTANT CAMELS ★

Planet earth needs you! Hostile aliens have used genetic engineering to mutate camels from normally harmless beasts into 90 foot high, neutronium shielded, laser-spitting death camels!! Can you fly your tiny, manoeuvrable fighter over the mountainous landscape to weaken and destroy the camels before they invade the human stronghold! You must withstand withering laser fire and alien UFOs. Game action stretches over 10 screen lengths and features superb scrolling, seamless 1/2 player actions and unbelievable animation! Play this game and you'll never be able to visit a zoo again without getting an itchy trigger finger! Awesome m/c action!

£8.50 - 50p P&P



ROX-64 ★

Rox is a challenging game involving the defence of your lunar base from a deadly meteor shower. Rox-64 includes amazing sprite graphics displays and spacy sound effects and an awesome 'mothership' display if you win the game. Top 10 scores are tabled along with their names. This program shows just what can be achieved using only Commodore 64 basic. Study the listing and learn to use sprites and sound on this outstanding machine.

£4.95 - 50p P&P

Post to LLAMASOFT SOFTWARE DEPT PCG
49, Mount Pleasant, TADLEY, BASINGSTON mp

NAME & ADDRESS	GAME	QTY

PLEASE ADD 50p TO ALL ORDERS



GRIDRUNNER - 64 *

The No 1 best game for the VIC has been improved for your COMMODORE 64! Gridrunner is a smash hit in the VIC. Now experience the lightning-fast challenge of the grid on the 64. Features 31 skill levels and excellent sound and graphics. Sore trigger finger FREE WITH EVERY GAME!!!

£5.00 - 50p P&P

SPECTRUM



GRAPHICS CREATOR (16K) *

Not just another character editor! Allows you to define not only the 21 user definable characters. Also allows you to change the entire 96 character ASC11 set. Creates BYTES files ready for you to load into your own programs. Includes advanced Reflect, Invert, Field commands etc. Complete with full documentation. Bin the BIN statement and use Graphics Creator with its easy on-screen cursor editing.

£2.95 - 50p P&P



BOMBER (16K) *

Yes a full feature version of the popular game. Blitz, supplied for the 16K or 48K Spectrum. For only

£2.95 - 50p P&P



HEADBANGER (48K) *

Colourful new game starring Chico the headbanger who you must guide to riches through an ever increasing shower of heavy metal. Gain bonuses for headbanging but be sure to take an aspirin when the pain gets too much! Basic - m/c to speed up the action. Great graphics, nice animation. Will even drive William Stuart system's voice synthesiser to produce speech output. Can you attain the grade of 'Rocker Class 1' or will you be 'Barry Manilow Class 5'? Start headbanging to-day and find out. £4.95



SUPERDEFLEX (48K) *

Bounce 'Sid' the space invader, around the screen into the power pods, keeping away of course from the devil who chases you around the screen. Steer with your Deflex shields, but beware the mines or you may be buried alive! Superb graphics and fantastic sound on the 48K Spectrum

£4.95 - 50p P&P



FOR VIC-20 (8K) and Commodore 64
FOR VIC-20: £6.00
FOR CBM 64: £8.50

ZX81



CENTIPEDE (16K)

The ORIGINAL game from the ORIGINAL author. This is the identical program to that being sold by other companies for three times our price. The game has received ecstatic reviews in the computing press. Program has 30 speed levels and ever increasing Centipede hordes. Tables top 10 scores and names. Why wait to pay more!

£1.95 - 50p P&P

ATARI 400/800



TURBOFLEX

Superb ultra-fast and totally new ball game. Uses ATARI's unique features to the full. Incorporates superb colour/sound effects and uses Player/Graphics. Tables top 10 scores along with Scorers name.

£6.00 - 50p P&P



GRIDRUNNER

100% machine code version of the best selling VIC/COMMODORE 64 game. Runs on any ATARI (16-48K). Blinding speed and superb graphics. Experience ATARI quality without paying ATARI prices. GRIDRUNNER for ATARI is just £8.50. Supplied on autoboot cassette. Discover the fastest and most exhilarating blast-em-up game ever devised.

£8.50 - 50p P&P



QTY	COMPUTER	PRICE

LLAMASOFT!! Computer Software

Dept PCG, 49 Mount Pleasant, Tadley, Basingstoke, Hants. RG26 6BN

Tadley 07356 4478

TRADE ENQUIRIES WELCOME

If your software's not on the menu, they won't be ordering it.

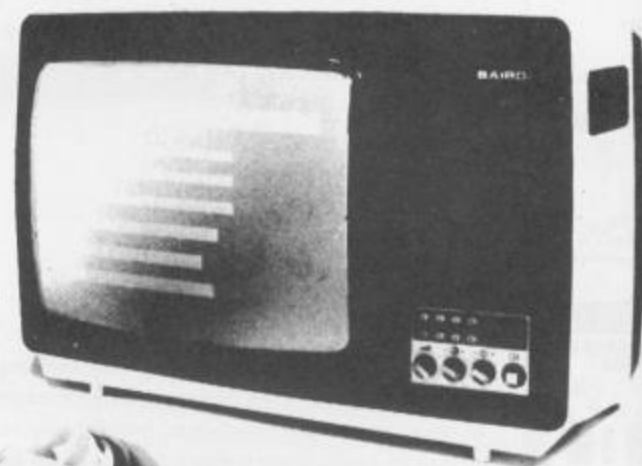

How would you like to sell your programs to thousands of genuine, enthusiastic and committed users?

If you're a professional supplier, how would you like to get rid of all those merchandising headaches on your general and games software?

And how would you like to do all this from just one cassette?

Micronet 800 makes all this possible.

When this huge database for microcomputers was launched just a few months ago, it attracted thousands of enquiries from educational, business and home users. Users who could see the huge new vistas opened up by linking them with Micronet 800...an 'Aladdin's Cave' of hundreds of programs which can be downloaded to machines like the BBC Micro, ZX Spectrum, ZX81, Apple II, Tandy TRS80, and PET...hundreds of thousands of pages of news, reviews, product data and prices from the computer world and from *Prestel*...and an electronic mailbox for exchanging messages and ideas with other users right across the country.

All this for around a modest 15p a day. Subscribers are linked by telephone through a modem...making it the fastest and most direct means of selling your software downline to genuine and serious buyers.

Right now, Micronet 800 is looking for further general and games software to add to its enormous library. This is an opportunity which authors and suppliers, professionals and hobbyists, simply can't afford to ignore.

Get on-line today and find out what you stand to gain from Micronet 800.



Phone Robin Wilkinson, Software Manager on Peterborough (0733) 237111, or send your disk or cassette together with the coupon to Micronet 800 to the address below.*

micronet
800

Micronet 800
Bushfield House
Orton Centre
Peterborough PE2 0UW

Name _____
Address _____

_____ Tel: _____
Name of Program _____
Type of Program _____ Type of Micro _____
<input type="checkbox"/> Please tick box if you are interested in becoming a Micronet 800 subscriber.

*We cannot return cassettes or disks unless a stamped addressed envelope is enclosed.

SCREEN SCROLL

SPECTRUM · ZX81 · ORIC 1 · BBC

GAME: GREAT BRITAIN LIMITED (48K)
SUPPLIER: SIMON HESSEL SOFTWARE
PRICE: £5.95
MACHINE: SPECTRUM
(VERSIONS ALSO AVAILABLE FOR ZX81 AND BBC)



I'm assured that the 16K ZX81 version of this is number 10 in the ZX software library. It's a colourful and sophisticated management game that gives you the chance to play at being prime minister of our sceptred isle. The idea is to stay in power for as long as possible. So you must end each five-year term in a popular state.

To start the game, you key in your name and then choose the party you represent - Labour, Conservative, Liberal or Social Democrat. This is not a decision to be taken lightly. I found that a Labour government always started on a much worse footing than the rest, particularly Tory. When the preliminaries have been completed, you are presented with a rundown of the current state of affairs.

Simon Hessel does stress that this is a game and not a simulation. But plenty of variables are taken into consideration - inflation and unemployment being the key elements. Each year begins with these two factors being updated along with the exchange rate, your popularity rating and the balance of the national account. Their movement depends on your performance in the previous year. There are three ways in which you can control these figures.

First you must set the levels of income tax, corporation tax, VAT and excise duties on tobacco, alcohol and petrol. These will determine your total income at the end of the year. They will also affect unemployment, inflation and your popularity rating.

Next you must set the levels of social benefits, including child allowance, pensions and unemployment benefits. The populace are particularly sensitive to any of these, especially to

pensions falling behind inflation. Finally, you are given the opportunity to plough money into some worthy cause in the hope that a social reform will be recognised. At the end of the year, news flashes will appear on the screen concerning riots or party revolts which may force you to revise your policies.

After five years an election takes place. You may be given the chance to outline your manifesto for the following term. This involves apportioning 1,000 points between four areas of social concern: inflation, unemployment, overseas aid, and law and order. Then you sit and watch as the results clock up.

Dick Olney

GAME: STOCK EXCHANGE (16/48K)
SUPPLIER: ASL SOFTWARE
PRICE: £4.50
MACHINE: ORIC 1

Company	Var.	S.P.	1	2	3	4
1) Ewing Oil	0	100	0			
2) ASL SOFTWARE	0	100	0			
3) Yoric Micros	0	100	0			
4) Sinclair Toys	0	100	0			
5) Larder Cars	0	100	0			
6) Borg Sports	0	100	0			
7) Ferrari Micros	0	100	0			
8) Mothercare	0	100	0			
9) Black Inc.	0	100	0			

PL: £ 5000
 B-BUY S-SELL X-PASS

This game came to me on the other side of Dungeons of Intrigue, but is being sold as a separate piece of software with an 'Etch-a-Sketch' program on the other side. The same difficulties in loading were experienced as with Dungeons, but after changing some program lines I eventually got it up and running.

The aim of the game is to make a killing on the stock market. You start with £5,000 and have the option of buying or selling shares in a range of companies like Ewing Oil, Yoric Micros, Sinclair Toys, Borg Sports, ASL Software and Mothercare.

I started by sinking all my cash into Yoric and ASL - and 'sinking' is the right word, because share prices in these companies promptly plummeted. I then spread what was left of my funds a bit more evenly, and gradually began to recoup my losses.

For each turn you have the option of buying, selling, or leaving things as they are; shares held, market fluctuation and cash in hand are all updated automatically.

One thing that began to annoy me was the fact that fluctuation in share prices seemed to be much too random

- it was very hard to discern any market trends. I enjoyed playing Stock Exchange but it didn't hold my attention for too long. It's the sort of game that is fun to play once or twice, but I can't see it proving addictive. Any number from one to four can play.

Steve Mann

GAME: ARCADE ACTION
SUPPLIER: ACORNSOFT
PRICE: £11.90
MACHINE: BBC

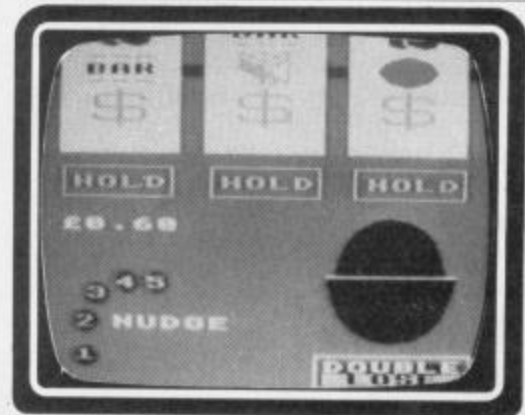

I must admit I am generally suspicious of multi-games packs, since they often disguise low quality. Perhaps surprisingly, after the way it approached the Atom software, this is the only such package that Acornsoft is offering for the BBC micro. It contains a selection of old favourites including Invaders and Breakout.

Invaders is a one- or two-player game with nine skill levels. Each player may choose a different level of play, which is a novel feature even for stand-alone Invaders. The game moves smoothly and quickly, with plenty of flying saucers and all the standard features. The invaders and saucers seem very large and are quite easy to hit at the start. But so is your base. They speed up quite dramatically when there are only a few left, and the last remaining invader really does move like a rocket.

Breakout is also of good quality and is attractively colourful. As well as the standard game there are three optional features: double bat, moving walls, and captive balls. Any combination can be chosen, giving a set of eight different games. As in many versions of Breakout, the bat moves quite slowly in normal mode. In this game, pressing the shift key gives double speed, a feature that I liked.

The third game on the cassette is another early arcade original, Dodgem. You move a car through a maze of six concentric square tracks with four crossing points between them. A computer-controlled car is travelling in the opposite direction and determined to get you. This ver-

SCREEN SCROLL

BBC · VIC 20

93 → sion is completely standard, with the favoured 'Z', 'X', '.' and '/' keys for movement and the space bar for acceleration.

Finally, we have an interesting variation on the game where you must avoid crashing into your own tail, now immortalised in the film *Tron*. Snake is a one-player game in which you guide a small white square around the screen attempting to eat 'food'. If you don't reach the food in time, it fades away. If you do eat it, your points are increased and the tail which follows the course of your dot grows a little. You end up with a long snake behind you. If at any point you guide the dot (now the head of the snake) into it or into the boundary lines, a life is lost. Each game consists of three lives. Snake is an interesting and surprisingly addictive variant of a stunningly trivial game. **DO**



Strategy, rather than zapping the enemy, is the theme of Harvester. It is intriguing rather than exciting, depending on planning more than fast hand-to-eye coordination.

Up to four people can play, each driving a harvester which gobbles dots scattered about the screen.

When the game is RUN, the screen fills up with coloured dots known as parcels of Boosterspice. The distinctive harvesters for each player are placed at random. To the right of the screen are simple direction codes: 1 for up, 5 for down, 8 for north east, and so on. You make a move by typing

in your personal code (A-D) and the direction code of your choice. You can take as much time as you like to make up your mind, and then use the Delete key to change it. Hitting RETURN makes the move.

The harvester trundles off, gobbling dots in your chosen direction as far as it can go, to a pleasant musical accompaniment. It stops when it hits the edge of the screen, meets another harvester or runs out of dots. Moving in a direction which is thus barred, without any dots left to gobble, ends the round.

The player's score is then reduced to zero and other players' scores are carried over the next round.

The strategy is to try to munch a line of dots in such a way that your opponent is isolated in as small an area as possible.

The graphics are simple but effective and include a rather powerful screen flash routine in the second half if you fail. The sound effects also work well. Harvester's biggest appeal is the fact that it is a game for the intellect rather than a sublimated desire to zap other entities. **Karl Dallas** → 97

GAME: HARVESTER

SUPPLIER: PIXEL

PRODUCTIONS

PRICE: £7.95

MACHINE: VIC-20



DJL SOFTWARE

DEPT SP, 9 TWEED CLOSE, SWINDON, WILTS SN2 3PU

Tel: (0793) 724317 Trade enquiries welcome

Export Orders: Please add £1.00 per tape airmail

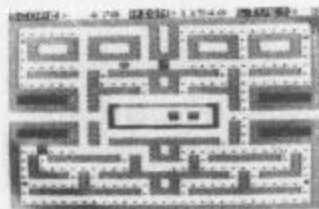

ZUCKMAN ZX81 (16K)

- * ALL MACHINE CODE (10K)
- * FOUR INDEPENDENT GHOSTS
- * HIGH-SCORE 'HALL OF FAME'
- * AUTHENTIC ARCADE ACTION
- * TITLE/DISPLAY MODE
- ONLY £5.95 INC. P&P



FROGGY ZX81 (16K)

- * MOVING CARS, LOGS, TURTLES
- * ALLIGATORS, DIVING TURTLES
- * FOUR 'SCREENS' OF ACTION
- * ALL ARCADE FEATURES
- * ENTIRELY MACHINE CODE
- ONLY £4.95 INC. P&P

★ NEW ZX Spectrum ★ FROGGY 16K or 48K

SPECTRUM VERSION OF ARCADE GAME WITH FULL ARCADE FEATURES:

- ★ Fabulous Hi-Res Colour Graphics
- ★ Authentic Sound Effects + 3 Tunes
- ★ 3-D Logs, Swimming & Diving Turtles
- ★ 3 Lanes of Multi-coloured vehicles
- ★ On-screen Score, Hi-Score, Time-bar
- ★ Snake, Alligators and Baby Frog
- ★ 'Top 5' High-Score initials table
- ★ Demonstration Game routine

Your home-sick frog must leap across a busy main road, then onto logs and turtles in the river to reach safety of the river-bank frog-homes. THIS MACHINE-CODE GAME MUST BE SEEN TO BE BELIEVED!!

ONLY £5.95 INC. P & P



Save £1.00

Save £1.00

Attention Vic 20 Owners

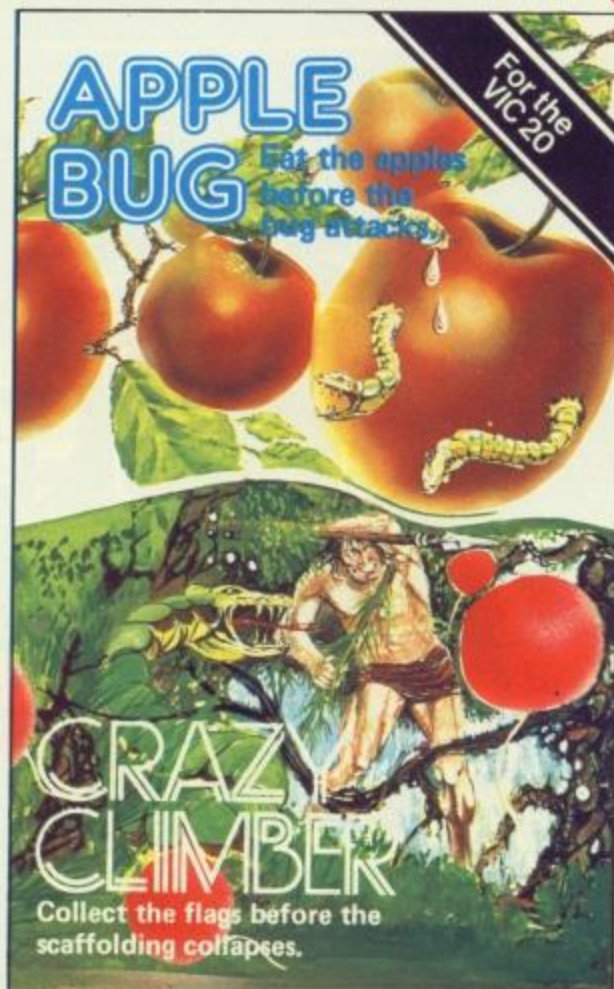
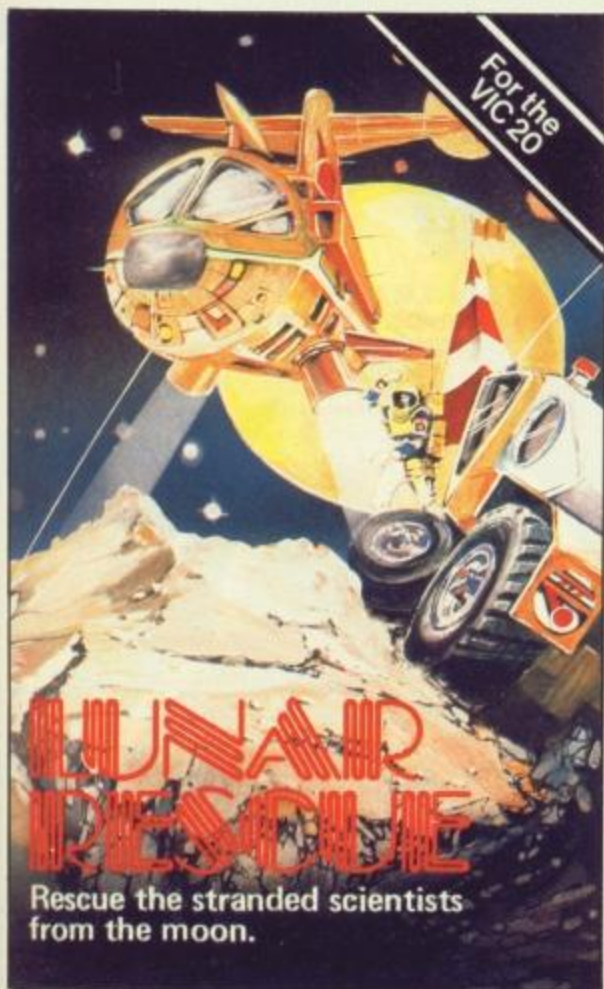

Introducing LYVERSOFT

High Quality WINNING GAMES

STOP PRESS!

NOW AVAILABLE FOR ANY VIC-20

DEMON DRIVER. Guide the Demon Car down the road and avoid the killer obstacles.

LUNAR RESCUE. Rescue the stranded scientist from the moon.

Simply complete the coupon below, indicating the number of copies required in the boxes provided, and post now to:

LYVERSOFT
 66 Lime St,
 Liverpool L1 1JN
 or ring our Hot Shot Credit Card Sales Line on 051-708 7100

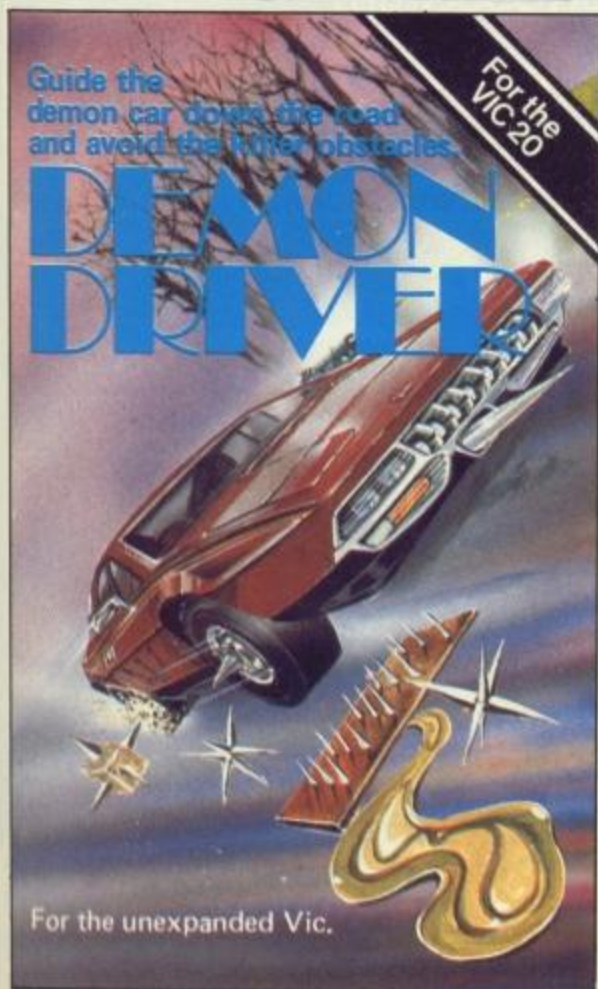

- VIC-20 Machine Code Monitor @ £14.95 each
- Lunar Rescue @ £5.95 each
- Demon Driver @ £5.95 each
- Applebug/Crazy Climber (2 pack) @ £5.95 each
- Nuclear Attack/Grand Prix (2 pack) @ £5.95 each
- Hearts & Diamonds/Hi-Lo (2 pack) @ £5.95 each
- Space Assault @ £5.95 each-For 3K & 8K VIC-20

For any VIC-20

Please debit my Access/Barclaycard (delete as necessary)

Card Number

I enclose Cheque/PO for £

Name

Address

Free Postage mainland UK only

MCP 06/83

NOW AVAILABLE FROM W. H. SMITH & SON, JOHN MENZIES AND BOOTS



TRANSYLVANIAN TOWER

A spectacular 3-D maze adventure for the 48K Spectrum

RICHARD SHEPHERD SOFTWARE

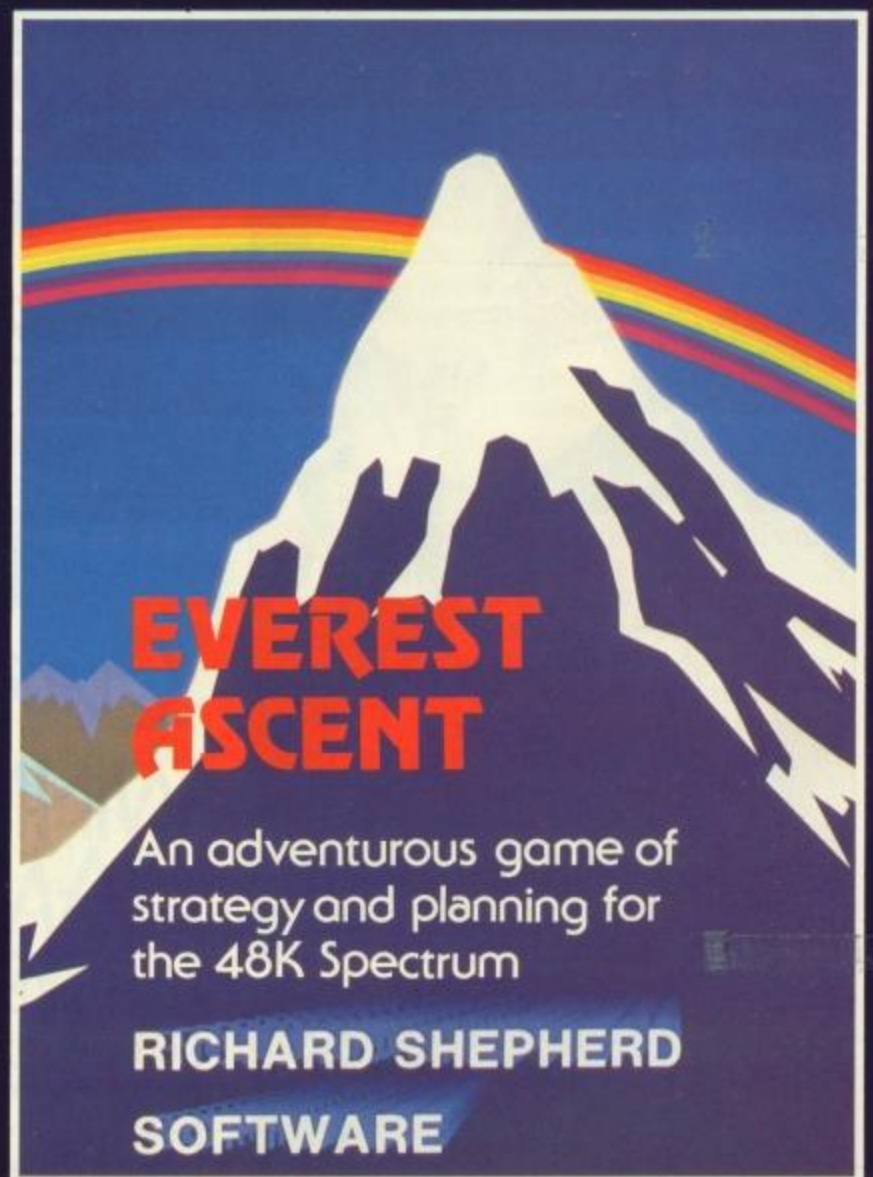

EVEREST ASCENT

An adventurous game of strategy and planning for the 48K Spectrum

RICHARD SHEPHERD SOFTWARE

TRANSYLVANIAN TOWER

A spine chilling adventure ... enter via the dungeons ... navigate your way through 500 3-D rooms ... survive the swooping vampire bats ... reach the terrifying top ... and rid the world of the evil Count Kreepie!

Can you survive the top of The Tower?

Full save routine for use during the hours of darkness!

48K Spectrum. **£6.50.**

Also available by mail order

SHIP OF THE LINE

Command a sailing ship ... juggle your supplies, crew and firepower ... fearlessly battle your way up the admiralty ladder, bribe Sea Lords as necessary ... until you make First Sea Lord! Full save routine. 48K Spectrum. **£6.50.**



EVEREST ASCENT

Conquer the world's highest peak in defiance of all the obstacles, men and nature can throw at you ... survive avalanches ... cross bottomless crevasses ... cope with wayward Sherpas — but don't run out of supplies!

Full save routine. 48K Spectrum. **£6.50.**

Also available by mail order

SUPER SPY

A global spy chase through complex puzzles, coded messages and 3-D mazes. Follow Dr. Death's trail ... locate his secret island ... discover the entrance to his lair ... but it doesn't end there! A different solution every game. Full save routine. 48K Spectrum. **£6.50.**

RICHARD SHEPHERD SOFTWARE

Dealers: Generous discounts available

Credit Card Hotline 0628 21107

All programs are sold subject to the condition that they may not, by way of trade or otherwise, be lent, hired out, resold or otherwise circulated without the written permission of Richard Shepherd

DISCOUNT: BUY TWO GET £1 OFF
BUY THREE GET £2 OFF
BUY FOUR GET £3 OFF

ALL PRICES INCLUDE VAT & FIRST CLASS UK POSTAGE
OVERSEAS ORDERS ADD £1.50 FOR AIR MAIL

48K EVEREST ASCENT	at £6.50	£
48K TRANSYLVANIAN TOWER	at £6.50	£
48K SUPER SPY	at £6.50	£
48K SHIP OF THE LINE	at £6.50	£
DEALER PACK	—	—
	DISCOUNT	—
	TOTAL	£

a) I enclose cash/cheque/P.O. payable to Richard Shepherd Software

b) Debit my ACCESS/VISA Card No.

with the sum of £ Signature

NAME ADDRESS

SEND IMMEDIATELY TO: RICHARD SHEPHERD SOFTWARE
FREEPOST (no stamp needed), MAIDENHEAD, BERKS, SL6 5BY

SCREEN SCROLL

UNEXPANDED ACE · APPLE II · COMMODORE 64 · SPECTRUM

GAME: MICRO MAZE

SUPPLIER: HI-TECH

PRICE: £6.50

MACHINE: UNEXPANDED ACE

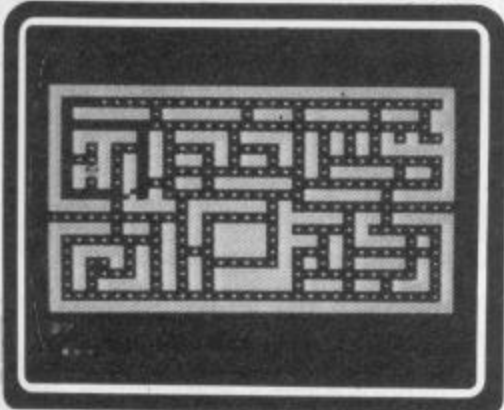

Again the instructions are confused between upper and lower case. Once this is sorted out, loading is straightforward.

Micro Maze is a simple Pacman-style game. You roam the maze, eating as many radioactive dots as you can, while keeping an eye open for the pursuing monsters. If you manage to clear one maze of all the dots, the screen clears and you move onto a higher level – with the monsters getting quicker, and much more likely to catch you. That's all there is to it – there are four levels of skill and you automatically move onto the next level as you clear the screen. You also have a choice of three mazes.

I found this game surprisingly enjoyable. Its best friends would hardly call it sophisticated, and the graphics are somewhat on the simple side. But it is surprisingly addictive and certainly worth a look if you own an unexpanded Jupiter Ace. SM

GAME: LUNAR LEEPER

SUPPLIER: SIERRA VISION

PRICE: £19.95

MACHINE: APPLE II

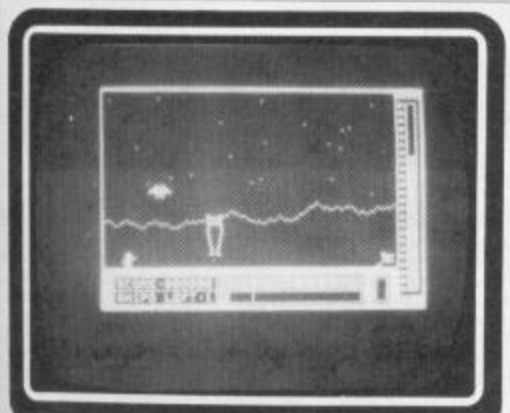

What a relief to play a game, get thrashed, collapse in heaps of laughter and then try again... and again... and again. If you are like me, you will laugh at the wrong times and forget what you are doing. It gives the program an extra advantage as you laugh away another life.

You are a spaceship above the moon, running out of fuel, and your shipmates are stranded on the surface. All you have to do is pick them up – by the head. Easy, you may think. Well, it would be if only the Lunar Leepers with their voracious appetites would stop eating the castaways and spaceships.

Once you have completed this task, stage two begins. Your mission: to boldly go where no spaceships should ever be and (fans of *The Perishers* cartoon strip will love this) shoot the eyeball in the sky. As luck would have it, the eyeball is at the end of a cave defended by Trabants.

The game is on one disk with accompanying fold-over instruction card. The instructions are brief but accurate and the game allows a keyboard, joystick or Atari joyport for controls. If the keyboard is selected, the player is asked to define which keys are to be used during play. Once into the game, the graphics and sound are excellent.

Starting at level one of eight, the play is relatively easy, as long as you suppress the odd chortle. In fact, it is worth making a few mistakes just to see the results. As you move up through the levels, more Leepers and spaceship-like Trabants hinder your mission. Eventually, Trabants become unkillable. This may be unfair but it does increase the excitement.

I so enjoyed this game that I assumed I was biased. But I coerced a couple of non-game players to have a go. Result? Addiction. Nigel Cross

GAME: MOTOR MANIA

SUPPLIER: AUDIOGENIC

PRICE: £8.95

MACHINE: COMMODORE 64

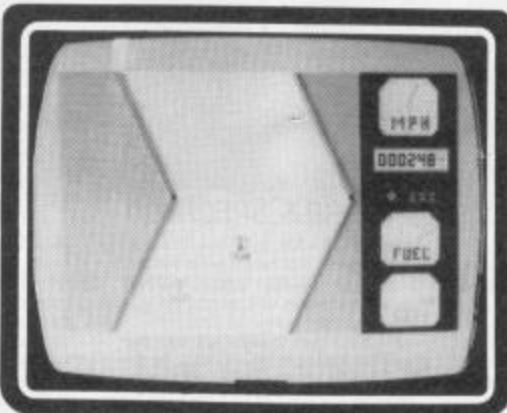

The Commodore 64 is very strong on sound, high-resolution graphics and colour. It deserves to have programs which will exploit these qualities.

Car-driving games are sufficiently testing to be a challenge while not being as frustrating as aircraft simulations. Choosing one of nine levels of difficulty, you steer your car around a track which includes motorway sec-

tions, ordinary roads and dirt track tests.

You will meet hazards – including slick patches and avalanches of boulders – on the way. You have to pass other road users, and the local ambulance crosses your path. There are realistic engine noises as you drive, and a constantly changing speedometer. You also have to keep an eye on a gauge which tells you if you are driving too slowly to keep your battery charged and on a fuel gauge that warns you to call in at a garage before you run out of petrol.

All this is complicated by hazards such as logs in the middle of the road – hitting one will cause your engine to overheat, signified by a flashing light followed by an oil warning light. If you fail to get to a garage in time, your engine dies. And there are potholes to make your steering go haywire.

Each map section completed earns an extra 1,000 miles. If you clock up 5,000 miles you get an extra car to add to the five you start with. If you still have four cars in the garage at this time, you score a massive 10,000 miles.

Motor Mania is a first-class arcade game of absorbing interest, and requiring considerable skill. It is a pity that it comes on cassette, even if a cartridge would be more expensive. This is because this is a game likely to be in great demand in the home, and waiting for the cassette to load will prove frustrating. Barry Miles

GAME: ARCADIA

SUPPLIER: IMAGINE

PRICE: £5.50

MACHINE: SPECTRUM

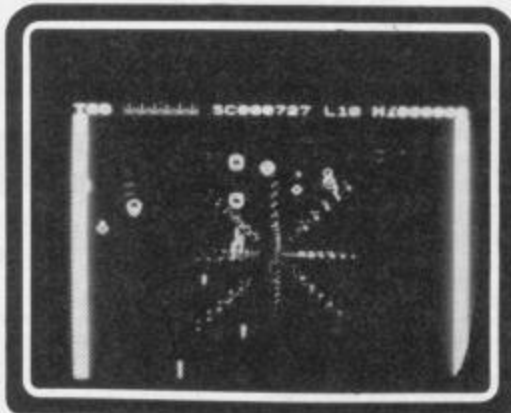

Now this really is something special... The bright young things at Imagine have confidently pledged themselves to the production of totally original arcade-style software for a variety of home machines – no Pacman rip-offs here.

First impressions of Arcadia are of a high degree of professionalism. The colourful cassette insert credits the game and graphics designers; take a

SCREEN SCROLL

SPECTRUM · BBC

97 bow, D Lawson and M Butler. Arcadia also offers a lifetime guarantee. If one of their games fails to load it will be replaced at once, free of charge. This is certainly a step to be encouraged. Instructions for setting up are clear and concise, and there's a touch of sly humour in that the alien beasties you are battling against belong to the Atari-an Empire. Of course, it could just be coincidence...

The object of the game is fairly standard zap-the-alien stuff. The alien fleets attack in waves, and there is a timer at the top of the screen. If you manage to destroy a whole fleet before the timer reaches zero, another replaces it. Conversely, if the fleet fails to destroy your ship (the Arcadia) in this time limit, it will break off the attack and home a new wave.

There is a wide choice of control keys, so it is easy to configure the keyboard to suit your particular finger-span. There is also a 'freeze' facility: any key on the top row halts execution, enabling you to take a break.

Arcadia is very deceptive in the early stages. Playing the game for the first time, it is highly unlikely you'll get

past the initial stage of fairly ordinary-looking alien ships. But as you improve you can appreciate the truly stunning graphics. There are 12 different waves of attackers: mutant butterflies, birds, spinning circles, octopus-type shapes, even a mini-Centipede game. If you manage to get through four levels intact, you get an extra ship (you start with five). I am told that there is someone out there who has reached the 53rd level, a claim I find hard to believe as the Atari Empire is no soft touch.

This cassette really does show that, given sufficient imagination, Spectrum graphics can match up to almost any other machine around. **SM**

GAME: PHILOSOPHER'S QUEST

SUPPLIER: ACORNSOFT

PRICE: £9.99

MACHINE: BBC

This is one of a pair of adventures which Acornsoft has included in its range of BBC software. The other one is called Sphinx Adventure. I suspect it is the easier of the two, although I haven't yet seen it. Philosopher's Quest is an interesting and complex

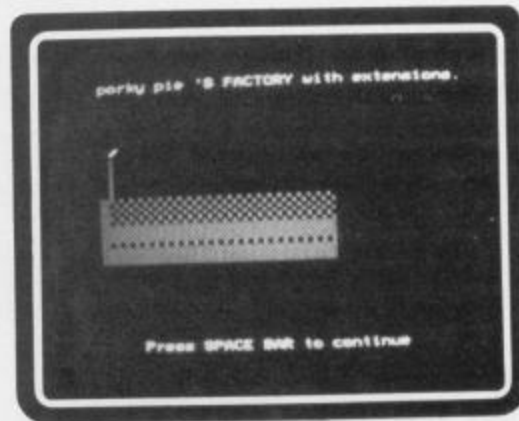

adventure with a fairly standard vocabulary.

The Ancient Mariner and his albatross make an early appearance. And in one room you apparently cease to exist! The text is varied, but without the humour of some adventures. It has the advantage of not repeating the full description of a room every time.

This game is one which would appeal only to the most patient adventurer, and could provide months of mental turmoil even for the most experienced. As you might have guessed, I hadn't got very far by the time this review was completed, but I haven't given up yet! **DO**

Brace yourself for a new generation of software



FOR 16/48 K SPECTRUM

3D TUNNEL - 16K/48K Spectrum
A full action graphics game to test your skill and nerve. What lies in the depths of the tunnel? Flying bats, leaping toads, scurrying rats, crawling spiders all appear in the depths of the moving tunnel. The 48K version also holds a surprise in store! **ONLY £5.95** Compatible with Kempston and AGF Joysticks. "3D Tunnel contains some of the most impressive graphics you're likely to see on the Spectrum". Computer and Video Games.



FOR 16K-SPECTRUM

ESCAPE - 16K Spectrum
You'll need plenty of stamina to escape the dinosaur infested maze. You'll have to find the axe and break out of the maze, but the Triceratops will be looking for you and the Pteranodon could swoop down on you at any time! **ONLY £4.95** "One of the best and most original games we have seen for the Spectrum so far" Sinclair User.



FOR 48 K SPECTRUM

KNOT IN 3D - 48K Spectrum. This is an action game, that needs nerve and quick reactions! Hurting through a void, your task is to travel as long as possible, scoring points along the way. Be careful though as you will have to avoid your own trail and those of up to four chasers. As trails are left you will have to thread your way through, but don't forget - the more trails the less space for manoeuvring. You will be terminated when you finally get caught in 'The Knot'. Compatible with Kempston, AGF and Mikrogen Joysticks. **ONLY £5.95**.



FOR 16K ZX81

3D DEFENDER - 16K ZX81
Fancy yourself as a spacefighter? Here's your chance to find out how good you would be in defending your home planet. A fast moving machine code game in 3D with meteors, stars, explosions, plasma blasts, photon beams and of course alien space craft to look out for! Your cockpit display will show shield strength, altitude, proximity, forward radar and your score. **ONLY £4.95** "Another 3D winner" Sinclair User.



FOR 16K ZX81

3D MONSTER MAZE - 16K ZX81
The ultimate 3D maze game for your ZX81, not only do you have to find your way out of the maze but you'll have to watch out for the T.Rex - it will actually run towards you when it sees you! Fast moving machine code graphics. **ONLY £4.95** "If I had to choose just one program to impress an audience with the capabilities of the ZX81, the 3D Monster Maze would be the one without doubt" ZX Computing.

Also available: **FULL SCREEN BREAKOUT** - 1K ZX81. **ONLY £1.95**.

REVIEWS
98



Please rush me:	Price	Cheques/PO payable to New Generation Software
<input type="checkbox"/> 3D Tunnel 16K/48K @ £5.95 inc.	_____	Name _____
<input type="checkbox"/> Escape @ £4.95 inc.	_____	Address _____
<input type="checkbox"/> 3D Defender @ £4.95 inc.	_____	_____
<input type="checkbox"/> 3D Monster Maze @ £4.95 inc.	_____	_____
<input type="checkbox"/> Full Screen Breakout @ £1.95 inc.	_____	_____
Please tick box	Total inc.	
New Generation Software The Brooklands 15 Sunnybank Lycombe Vale Bath Avon BA2 4NA		
All games written by Malcolm Evans-The 3D expert. For instant despatch phone 01-930 9232 and quote your credit card number.		

New Generation Software

STARTTECH

Absolutely
the lowest
prices!



VIC 20

16K RAM PACK

£28.95

Including VAT and Postage and Packing.

Tick for further information

- VIC 20 PRODUCTS
- COMMODORE 64

All prices subject to availability or change without notice.

PLEASE SEND ME

VIC 20 16K RAM PACK

Qty

Price

£28.95

TOTAL

(24hr. ANSAPHONE SERVICE)

Name _____

Address _____

I enclose Cheque, P/O for

CREDIT CARD ACCESS BARCLAY CARD

P.C.G.1

STARTTECH

208 Aigburth Rd, Aigburth, Liverpool L17.051 727-7267



List now includes NEW Apple II E

**Inc VAT
and
Net carriage**

Apple IIe 64K	625.00	722.00
Apple Disk + Controller	275.00	319.00
Apple Disk without Controller	199.00	229.00
Micro-Sci Disk + Controller (A40)	275.00	319.00
Micro-Sci Disk without Controller (A40)	199.00	229.00
Zenith 12" Monitor	69.00	84.00
Apple 80 Column Card IIe	60.00	70.00
Apple 80 Column Card IIe + 64K Expansion	145.00	167.00
Bit 3 Full View 80 Column Card	175.00	205.00
Multiplan	159.00	185.00
Quickfile IIe	49.00	58.00
Applewriter IIe	99.00	116.00
TV Modulator	11.50	13.00
Dos 3.3 Toolkit	35.00	42.00
Epson RX80 Printer	269.00	315.00
Epson FX80 Printer	379.00	443.00
Epson MX100 Printer	425.00	495.00
Apple Interface for Epson	75.00	86.00
Visicalc 3.3	121.00	140.00
Visitrend/Plot	159.00	185.00
Visifile	139.00	162.00

**NEW SOFTWARE (ON CASSETTE)
DRAGON**

Dragon Magic No. 1 — 12 BASIC programs including BRICKOUT, 3-D EFFECT and useful household programs that start where the manual leaves off	6.04	6.95
Dragon Magic No. 2 — 10 more advanced programs in electronic magazine format to take you deeper into basic programming including PSYCHIC TEST, VALLEY BOMBER, etc.	6.04	6.95
Dragon Wordprocessor (EDITEXT) (for Dragon 32 + Printer)	11.96	13.75
BBC MICRO (MODEL B) Twin Joysticks (true analogue) (uses analogue port)	13.00	16.00
Vogon Attack (with super graphics) + Shuttle Lander, Towers of Hanoi, Robot Battle and Four in a Row	6.04	6.95
BBC Games Tape 2 — includes: Death Castle, Adventure Maze, Battleships, Mastermind, Rat Shoot, Number Invaders and Computer Hangman	6.04	6.95
7 Educational games for 6-10 yr olds	5.17	5.95
SPECTRUM 9 Educational Programs for 4-7 yr olds	5.17	5.95
RESEARCH MACHINES Single Joystick for RM 480Z	9.57	11.00



Cash with order

**MICROMAIL LTD., P.O. BOX 34 (DEPT. PCW),
Leighton Buzzard LU7 8SJ
Telephone: (0525) 376600
Barclaycard/Access accepted.**

DRAGON/ATOM/ORIC-1

ADD LOW-COST I/O POWER WITH A VIA BOARD

Drive extra I/O devices, from LEDs & switches to extra peripherals. Link 2 micros for data/program transfer, spool listings to a second micro to print/save etc. (see TEVLINK below).

HARDWARE: 6522 VIA provides 16 I/O lines + control, serial port, 2 timers, interrupt register. I/O, voltage & interrupt lines taken to 26-way IDC plug for easy connection to peripherals etc. Connectors available for Dragon, Atom; Oric 6522A version should be out soon. The Board may be interfaced to most other 6502/6809 micros, and may be shared between m/c's by changing the plug-in connector.

SOFTWARE: 'TEVLINK' package provides 2-machine parallel link (2 Boards needed), overall speed about 8K DATA bytes/second with error checking. A PRINT SPOOLER is included (only 1 Board needed): connect printer port to VIA board on receiving micro and use normal LIST/PRINT etc.

Dragon/Atom cassette.....	£7.75
Assembled board + Atom connector.....	£18.75
Assembled board + Dragon connector.....	£18.75
Assembled board only — for your interface.....	£14.00
Atom connector.....	£4.00
Dragon Connector.....	£6.00

PROFESSIONAL QUALITY DRAGON SOFTWARE:

TML-DATABASE: A flexible, general-purpose data filing and retrieval program, with an "Auto-Reminder" feature for birthdays, appointments etc, plus a powerful search facility. M/code program..... £9.75

TML HOME ACCOUNTS: Record and analyse your income and expenditure by User-defined groups. Four levels of classification. Also suitable for small business applications..... £7.75

ORIC: TEVROG'S KINGDOM: A real-time "classic style" adventure for the 48K Oric..... £5.75

★ Other software and hardware available soon ★

WANTED!! Good software (games & serious) for royalties or outright purchase. Send for details.

MAIL ORDER ONLY. SEND FOR LISTS/DETAILS
All prices fully inclusive of VAT, p&p etc.



Tevward Microtech Ltd.
(Dept. PCG), 403 Dallow Rd., Luton LU1 1UL
Telephone: (0582) 418906

PCG



CompUtopia
LIMITED

At last — a Printer for every Pocket!

**MICROMAX — SPECIAL
INTRODUCTORY OFFER
ONLY £69 + VAT**

**SPEED SELECTABLE . . .
SERIAL OR PARALLEL
INTERFACES AND
CABLES AVAILABLE FOR:
SINCLAIR ZX81 . . .
SPECTRUM . . . VIC . . .
DRAGON ETC . . .**

**UP TO 24 STANDARD OR
ENHANCED CHARACTERS
PER LINE . . .**

s.a.e. please for details to 30 Lake Street, CA5/83
LEIGHTON BUZZARD, Beds. Tel: 0525 376600

SCREEN SCROLL

ATARI · IBM PC · APPLE II

99- **GAME: EASTERN FRONT**
SUPPLIER: ATARI PROGRAM EXCHANGE
PRICE: £23.99
MACHINE: ATARI

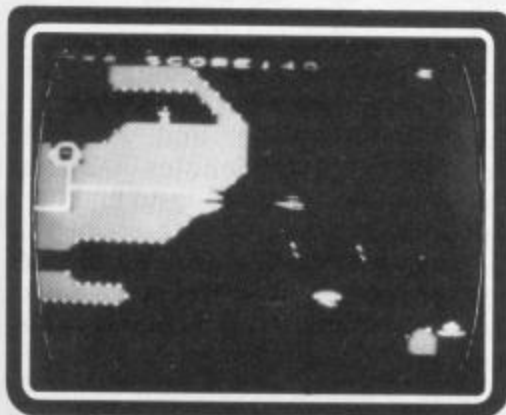

This is one of a large selection of packages distributed by Atari but written by non-Atari personnel. Atari does apparently pay quite good royalties if the program sells and it's a good way of making available software which might otherwise never be published. Eastern Front has achieved such success that creator Chris Crawford has been given a job with Atari's elite software team in California.

The game is a one-player simulation of the German invasion of Russia during World War II, in which you have the job of controlling the German forces. The playing field is a map of Western Russia, covering three or four screens' length in each direction. Using a joystick, you move a purple square around the map, which scrolls over if you reach the edge of the screen.

Russian military units are seen as red squares, and German ones as white. To identify any unit and its strength, you must position your purple square over it and press the fire button on your joystick. Each turn you may give up to eight orders to each German unit. These amount to instructions for movement in a particular direction. They are given by pressing the fire button whilst your square frame is in position over the appropriate unit, and – keeping the button pressed – moving the joystick in the direction you wish the unit to move (not diagonally).

When you have completed your orders, pressing the start button initiates the procedure which figures out their results. A unit will not carry out all your orders exactly for a number of reasons. Firstly, it may come into conflict with an enemy unit by trying to move into the other's space. In this case, the result of the conflict will be determined by the fighting strength of each unit along with various random

factors, and one unit will be forced to withdraw. Associated with this is the inability, under certain conditions of, your unit to move through a Russian unit's zone of control.

Secondly, a German unit cannot move into a space already occupied by a friendly force, and will merely wait until the other has moved. Finally, the number of spaces which a unit can move each turn is limited by its own nature (infantry or tank regiment), the terrain it is crossing and the season of the year. The game runs from 22 June 1941 to 29 March 1942, with each turn representing one week; the current date is displayed at the top of the screen.

Your score appears in the bottom left hand corner and is reassessed each turn, the idea being to end the game with the highest score possible out of 255. Since this score fluctuates in both directions, there is no point in playing part of a game. As there is no game-save feature, you will have to leave your computer on or allocate several hours each time you boot up the disk.

The graphics are the most obviously impressive feature, with the colours changing according to the season. There can be no doubt that this is a fine piece of programming. **DO**

GAME: ULYSSES AND THE GOLDEN FLEECE
SUPPLIER: SIERRA ON-LINE
PRICE: £25.30
MACHINE: IBM PC
(VERSIONS ALSO AVAILABLE FOR APPLE AND ATARI)



'You must become Ulysses,' says the manual. 'Your task: to find the Golden Fleece and return it to the King. The perils are many, your foes powerful. But with courage, logic, intuition and luck, you can survive and take with you the secrets of sorcerers. Now, sit back, close your eyes, and I'll spin a spell to open time's portals ...'

The game is for one player and is set in a number of locations, including the King's town, a tavern, a shop and Colossal Island. Each location has its own picture, which comes on the

screen when you get there – in the time I was playing, I found at least 20. In each of these places you will bump into people – guards, sailors, shopkeepers – or stumble across objects to take on your quest.

If you stumble across a mysterious floating bottle, for instance, you just type GET BOTTLE. The item is then added to your baggage and disappears from the picture.

You start off in the town. From there, you can move north, south, east or west. You may speak to anyone you meet, to see whether they have any helpful information. Robbers may steal some or all of your possessions. You may be able to buy something – or you may find that what you thought was money isn't legal tender here.

The instruction book does not tell you much about what you can or cannot do. Part of the fun is finding out for yourself, and you will need to use your imagination to find the right commands. The game certainly has a sense of humour. When I was unable to get any sense from a guard, I typed in KILL GUARD. The response was 'That wouldn't be nice. Besides, he's bigger than you'.

I was not particularly impressed with the graphics – I've seen better on micros such as the Apple or Atari. But only a mad millionaire is going to buy an IBM PC for games. This game, and others like it, will be played by the boss in the evenings. It could give a new meaning to 'working late at the office tonight, dear'. **Mike Whitney**

GAME: THE DARK CRYSTAL
SUPPLIER: SIERRA ON-LINE
PRICE: £
MACHINE: APPLE II



This is an adventure game in the great tradition. You are Jen, last of the Gelfling race which was exterminated by the evil Skeksis. They control the land with the aid of the powerful Dark Crystal, damaged centuries ago when a shard broke off and was lost. Now you must find the shard, heal the crystal and defeat the Skeksis.

Getting the game up and running

SCREEN SCROLL

APPLE II · ORIC 1

101 → could not be simpler. You gently shove the disk in the drive and boot. The first picture on the screen shows Jen sitting on a rock playing his pipes. From then on, it's up to you.

The game is sixth in the Sierra-Online Hires Adventure series and uses the same code as the previous ones. I found it more frustrating than its forerunners, and more arbitrary. One classic example is the time I was spotted by a bat with a crystal eye. It took only one bat-sighting, followed a few turns later by the appearance of one of the Garthim (invincible nasties) to hammer home the message that Bats Meanz Garthim. I got killed that time.

After rebooting and retracing my steps from the map I had drawn so carefully, I was spotted by another bat. I was only two moves away from the hill where the Landstriders grazed, so I headed for it and arrived just in time. Then up came a Garthim. To my intense displeasure, I discovered that being in the presence of Landstriders – who get their kicks in life by kicking the life out of Garthim – makes not one bit of difference. You wind up just as dead.

In an adventure game there are very few situations in which an operator error can cause a problem. In the case of the Dark Crystal, the need to load each picture-file from disk means you could confuse disks, causing a 'file not found' error. The same problem could occur when you move from one disk to another. In both cases, the program explains what the machine thinks might be happening.

It is best if you play this on a colour TV as it loses most of its appeal in mono. However, since it is based on the American TV standard, the colours are blurry.

Richard King

GAME: ZODIAC

SUPPLIER: TANSOFT

PRICE: £9.99

MACHINE: ORIC 1

Zodiac is a full-length adventure for the 48K Oric. Using slow format, the program loaded successfully, but took half an hour to do so.

This features a very large vocabulary and uses the large memory to very good effect. It's a standard text adventure. You start in a small hut and wander through various locations re-

trieving treasure. There are six valuable objects to be retrieved and it will take you a long time to complete the whole game – Tansoft reckons five hours for a seasoned adventurer and 50 or more for the novice.

There is a good range of locations and plenty of detailed description. If you find yourself in a room, the Oric will tell you that it has high ceilings, a sturdy mantelpiece and exquisite panelling, which denotes that the house owner has good taste and high financial standing. You are not restricted to simple verb/noun instructions. You can add descriptive adjectives which will affect the way the computer carries out your orders.

Music is added at relevant points of the adventure – at one location you come across a radio that is playing the theme tune from the Archers. This detracted from my enjoyment as the sound did terrible things to the screen display. I assume that production Orics are now free from this annoying feature.

Sound bugs aside, this is a very nice piece of software. I am not an adventure addict, but I think this is a game I would return to.

SM → 11

TRIONIC

TRIONIC IN-HOME ENTERTAINMENT CENTRE
144 Station Road Harrow Middlesex
Tel: 01 861 0036
(Open 10am to 6pm Monday-Saturday)

save ££££ save ££££ save ££££ save ££££ save ££££

Just fill in the coupon below and present it to TRIONIC when making your next purchase to CLAIM 5% OFF ALL Atari Commodore and Sony Equipment (Atari 400/800, VIC 20/64, Sony Televisions/Videos/Hi-Fi/Walkmans) AND All Computer Software & Accessories.

We have one of the BEST Video Libraries in HARROW – Rental £2.00 per night. You can also rent Sony Television & Video from us.

I DEMAND 5% OFF Name: _____
My Total £..... Address: _____
Purchase Saving _____
£..... Tel. No: _____

save ££££ save ££££ save ££££ save ££££ save ££££
Mutilate this Magazine!!!
Fill in the coupon and CLAIM 5% off!!!

BUFFER MICRO SHOP

310 STREATHAM HIGH ROAD, LONDON SW16 6HG
Tel: 01-769 2887

Open Tues-Sat 10.30 am to 5.30 pm (Closed Mondays)

Software from all the best suppliers
Over the counter
Plus growing range of peripherals
See it 'n try it before you buy it

SAE appreciated for catalogue – but please specify for which computer

DRAGON

ZX SPECTRUM

ZX81

The World's Greatest Range Of
SINCLAIR SOFTWARE
Pioneers in 1981 – way head today

BBC-ACORN

VIC 20

KEYBOARDS * ADD-ONS * CASSETTES * BOOKS

NEW! – BUFFER CLUB for regular customers. Special Offers – Lectures – Foreign Trips – Software Promotions. Ask for details of membership on your next visit.

MEMBER OF THE COMPUTER TRADE ASSOCIATION – YOUR FAIR DEAL GUARANTEE

VISA - ACCESS - AMERICAN EXPRESS - DINERS CLUB
ALL CARDS WELCOME

sbd

Software

Choose from over 100 titles with the SBD Summer Collection



Apple Panic	£22.00	Mission Asteroid	£12.95	Legacy of Llylgamyn (3rd Scenario)	£26.95
Bandits	£22.00	Mystery House	£14.95	Zork I	£29.95
Beer Run	£17.95	Mouskattack	£22.00	Zork II	£29.95
Blade of Blackpoole	£24.95	Napoleon's Campaign	£45.00	Zork III - new	£29.95
Cannonball Blitz	£22.00	Olympic Decathlon	£22.00		
Cartels & Cutthroats	£29.95	Pegasus II	£19.95	ATARI	
Castle Wolfenstein	£22.00	Pest Patrol	£19.95	Bandits (48K disk)	£22.00
Choplifter	£24.95	Phantoms Five	£17.95	Crossfire (disk or cass.)	£19.95
Computer Foosball	£17.95	Photar	£22.00	Cyclod (48K disk)	£17.95
Computer Air Combat	£45.00	Pinball	£22.00	Frogger (disk or cass.)	£22.00
County Fair	£22.00	Pursuit of the Graf Spee	£45.00	Golf (cass.)	£14.95
Cranston Manor	£22.00	President Elect	£29.95	Jawbreaker (disk or cass.)	£19.95
Crossfire	£19.95	Repton	£24.94	Lunar Leeper (disk)	£19.95
Critical Mass - new	£24.95	Robot War	£29.95	Maurauder (disk)	£22.00
Cytron Masters	£29.95	S.E.U.I.S.	£29.95	Mission Asteroid (disk)	£14.95
David's Midnight Magic	£24.95	Sargon II Chess	£24.95	Mouskattack (disk)	£22.00
Dark Crystal - new	£24.95	Scrabble	£21.70	Snake Byte (48K disk)	£17.95
Epoch	£22.00	Skiing 3D	£17.95	Sneakers (48K disk)	£17.95
Escape from Rungistan	£17.95	Snack Attack	£22.00	Space Eggs (48K disk)	£17.95
Falcons	£22.00	Snake Byte	£17.95	Soft Porn Adventure (disk)	£19.95
Flight Simulator	£26.00	Sneakers	£17.95	Threshold (disk)	£24.95
Fly Wars	£17.95	Soft Porn Adventure	£19.95	Ulysees & the Golden Fleece	£24.95
Free Fall	£17.95	Space Eggs	£17.95	Wall War - new	£24.95
Frogger - new	£22.00	Swashbuckler	£24.95	Way Out (48K disk)	£24.95
Galactic Gladiators	£25.95	Threshold	£24.95	Wizard & Princess (disk)	£22.00
Guadal Canal Campaign	£45.00	Time Zone	£55.00		
Gorgon	£24.95	Track Attack	£22.00	IBM	
Hadron	£22.00	Twerps	£17.95	Call to Arms	£24.95
Jawbreaker - new version	£19.95	Type Attack	£24.95	Crossfire	£19.95
Kabul Spy	£22.00	Ultima II	£37.50	Frogger	£22.00
Laff Pak	£22.00	Ulysees & the Golden Fleece	£22.00	Mouskattack	£22.00
Lemmings	£17.95	Way Out	£24.95	Ulysees & the Golden Fleece	£22.00
Lunar Leeper	£19.95	Way Navy	£22.00	Wizardy	£39.95
Marauder	£22.00	Wizard & the Princess	£22.00	Zork I	£29.95
Minotaur	£22.00	Wizardy	£28.95	Zork II	£29.95
		Knights of Diamond (2nd Scenario)	£21.00	Zork III	£29.95

All prices plus VAT @ 15%

FOR ACCESS/BARCLAYCARD/AMEX ORDERS,
PHONE OUR GAMELINE ON



01-870 9275
(24 hour service)

KRAFT JOYSTICKS

Apple Joystick **£42.00**

The Kraft Joystick features "free-floating" and "spring-centreing" stick modes, giving versatility and precision performance suitable for both business and computer games applications, as well as many paddle applications. Superior button placement easily permits simultaneous firing action virtually impossible with other "thumb-oriented" joysticks.

Atari-compatible Joystick **£13.95**

Kraft's high quality, "digital" Joystick features finger-tip control and accuracy for higher scores and much longer life. It is plug-in compatible with Atari VCS, Atari 400/800, Commodore Vic-20, Commodore 64, and Texas Instruments 99/4a.

To SBD Software, FREEPOST, OSIERS ROAD, LONDON SW18 1BR.

Telephone: 01-870 9275 (24 hours)/01-870 9386

Please send me the following items:

Description	Price	VAT	Total
Add 75p for Postage and Packing			0.75

I enclose cheque/postal order for Grand Total £

Please debit my Access/Barclaycard/Amex (delete as app.) Number

Exp Date

Name

Address

£20

SCREEN SCROLL

SPECTRUM · DRAGON 32 · ZX81 · BBC

102 → **GAME: FOOTBALL MANAGER**
SUPPLIER: ADDICTIVE GAMES
PRICE: £5.95
MACHINE: SPECTRUM

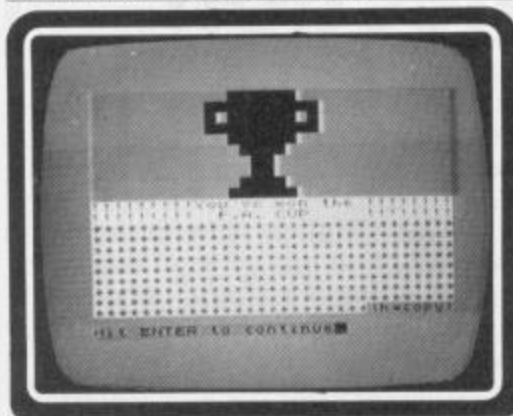

When I first received this game, I spent the best part of a weekend playing it. Since then, I have returned to it more often than any other.

The object of the game is to pilot your chosen team from division four to the league championship, on the way winning the FA Cup as often as possible. The game mirrors reality in that a good Cup run will give you greater attendances, hence more money at the gate. Conversely, losing too many games cuts your income and can result in you getting the sack.

You have a maximum of 16 players in your squad and can buy or sell as the situation dictates, borrowing from the bank as necessary. You can change players' names to suit your own foibles and prejudices. Unfortunately, your players must have names of eight letters or less, including initial, so there's no room for Kenny Dalglish.

Loading Football Manager for the first time, you are invited to enter your name and then choose a team from the 64 on offer. No matter which team you choose, you start the game in division four – which must be particularly galling for Liverpool fans. If your favourite team is not represented, you can select any of the others and then change the name. You select your skill level from a choice of seven, ranging from beginner to genius. You then choose your team's colours – this is not too realistic as you are restricted to black or white – and the game begins.

The truly addictive quality of this game is the remarkable way it mirrors a real football manager's problems. Each player in your squad is rated between 1 and 5 in skill. This rating affects his price in the transfer market and his cost to you in wages. In addition, each has an energy value of 20 or less. Each game played reduces this value by one, while resting the

player for one game boosts his energy by 10. Your team's performance will depend on values obtained from the skill and energy ratings of the players, plus a morale factor. Lose games and this goes down, making you more likely to lose again. This is identical to a real team's performance.

So far, the game is purely textual. Now the fun begins. Having selected the most suitable team for the forthcoming game (you have a dossier on your opponents' skills, morale and energy), you have to sit back, biting your nails like any real manager, while the game is played. This is done in a series of goalmouth scrambles. Successful shots are greeted by an electronic scoreboard flashing 'GOAL!' and the match score is displayed.

It should be stressed that this is not a short game – there are 15 games in a season, plus the various rounds in the FA Cup. To get from division four to the league championship at any of the higher skill levels is going to take you a week of playing every day. **SM**

GAME: PIMANIA
SUPPLIER: AUTOMATA
SOFTWARE
PRICE: £10

MACHINE: SPECTRUM
(OTHER VERSIONS AVAILABLE FOR DRAGON, ZX81 AND BBC)

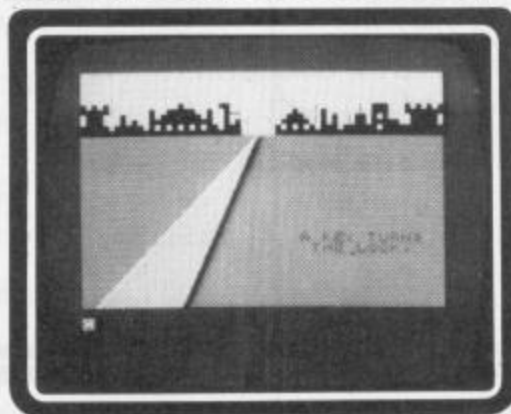

I'm not too sure that Christian Penfold and Mel Croucher should be allowed to walk the streets. Both of them are obviously warped ...

What we have here is a world where saxophones turn into hang-gliders, where red herrings swim across the bottom of the screen blowing bubbles of derision, and where snatches of music confuse, hinder and occasionally help you. Along the way you'll be greeted by a blatant appeal for cash – they promise to send you a T-shirt, but what makes you think you can trust them? Throughout your adventures you'll be involved with the Pi-Man who will give you presents of useful things like blackboards, then next minute rob you blind.

It's a game that encourages all that is noble in the human spirit – namely naked, ravaging greed. The prize is a specially designed £6,000 gold and diamond sundial. Whoever wins it will certainly deserve it, but will undoubtedly be a gibbering lunatic by then.

Seeing as there's so much at stake, I'm not going to tell you too much – why should I help you get rich? Suffice it to say that it's an adventure. But the objects are not your run-of-the-mill swords, magic rings and potions – you pick up TV dinners, cans of worms, handfuls of valium ...

The object is to get through the Gate of Pi, which will reward you with a place name and date. Turn up at the appointed time and an Automata person will hand over the goodies.

There are potential clues in everything, probably even in the horrendous 'disco single' on the other side of the program tape.

The Pi-Man does a mean hokey-cokey. The animation makes nonsense of the fact that the Spectrum is a slow computer. And the cassette case should carry a government health warning: this game can damage your brain. It would appear that Automata staff are not expecting an early winner – if no one shows up on the first date set they promise to return at the same time on the same day of every year until the prize is won. **SM**

GAME: MONSTERS
SUPPLIER: ACORNSOFT
PRICE: £9.95
MACHINE: BBC

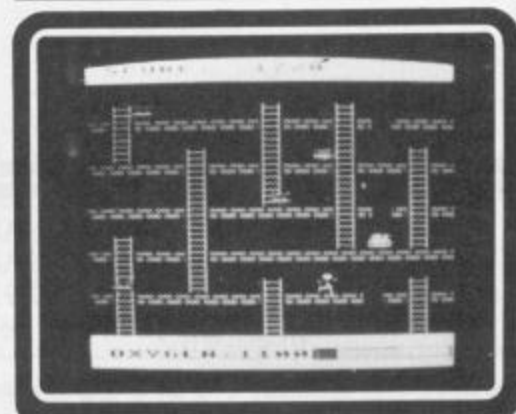

One of my arcade favourites is a game called Space Panic. Monsters is an exact reproduction of the original, right down to the sound effects.

You control a neatly drawn little man who runs around five floors linked by various configurations of ladders while being chased by monsters. As you might guess, the idea is to kill all the monsters as quickly as possible. Instead of a weapon, the little man is equipped with a spade with which he can dig and fill in holes. **11**

SHARDS SOFTWARE

189 ETON ROAD, ILFORD, ESSEX IG1 2UQ

We proudly introduce...
for the Dragon 32...

'EMPIRE'

THERE IS NO HIDING PLACE

- * Enthralling new game for your Dragon 32
- * Exciting game of strategy for one player
- * Destroy the evil Dragon Empire before it conquers the world
- * Includes 7 world maps and on screen scoring
- * 8 levels of difficulty
- * Automatic playing feature ... sit back and watch the world being overwhelmed
- * 100% high resolution graphics with machine code
- * No joystick needed
- * Full printed instructions
- * Available for only £6.95 (inc. VAT) from your local dealer or by mail order at the above address



QUEST

MICROSOFTWARE



SIMPLY THE BEST

Momentum is building fast with the **BLACK HOLE** High Score **COMPETITION**. Leading score so far is an amazing 2530 sent in by Russell Capel of Swindon Village, Glos.

When we designed the **BLACK HOLE** we decided to provide a real challenge for the player - and we appear to have succeeded since very few people have managed to pass the 'magic' barrier of 1000. Could YOU be the next?

Our second game, **VIOLENT UNIVERSE**, is now available and will run on any Spectrum. In addition to having the same addictive and challenging qualities as The Black Hole, and another totally original game plan, the **VIOLENT UNIVERSE** offers a complete visual experience with its animated graphics and violent explosive effects.

QUEST - A NEW DIMENSION IN SPECTRUM SOFTWARE - The battle could be yours ... but it won't be easy!

THE BLACK HOLE and **VIOLENT UNIVERSE** are available from **QUEST, 119 THE PROMENADE, CHELTENHAM, GLOS** at £5.50 each

or from your
local software retailer
For details please ring

0242-583661



New from ...

MIKRO-GEN

SPECTRUM Software

COSMIC RAIDERS (16K) £5.95

You - the only remaining pilot of the "Earth Defence Fleet" - have the daunting task of defending the Earth from attack by alien beings that have already set up a base of their own on earth.

- * Radar Scanner display in hi-res *
- * Full colour and sound effects *
- * From the author of Spectrum 'Scramble' *
- * 100% machine code *



SPACE ZOMBIES (16K) £5.95

Shooting through space you are ambushed by a fleet of Space Zombies flying at you in formation, swooping and diving at you. Destroy them, if you can! But in destroying them, you attract more to the area, and the game gets progressively harder.

- * Full screen hi-res graphics *
- * 1 or 2 players * Joystick option *
- * Three playing speeds *

MINES OF SATURN and RETURN TO EARTH £5.95

Mines of Saturn While piloting a routine orbit of Saturn you are caught up in a radiation storm which forces you into the giant planet's rings. Your energy drained, you make a forced landing on the planet's surface. Luckily you crashed near an abandoned mining base and you set off in search of some di-lithium crystals to refuel your stranded space ship. Can you do it?

Return to Earth Having escaped from your previous dilemmas, you reach Earth Station 1, but fail to make radio contact. You effect a safe if harrowing manual docking. On entry you find it deserted, and the control room destroyed. You must explore the station and find some way to alert Earth of your predicament, but beware, many of the rooms are identical, there is extensive damage, and signs of alien intruders.



Graphic Adventure (48K) MAD MARTHA £6.95



Poor little Henry is the hen-pecked hero of this domestic tale. One night he can take no more. He steals his wages from his wife's purse, sneaks out of the house being careful not to wake the baby or trip over the cat, and heads for the bright lights to have some fun. Trouble is he runs out of money. His only way to raise some cash is to gamble his few remaining pounds on the spinning wheel of the roulette table. Just as Henry is getting into his evening his wife - Mad Martha - has noticed his absence. Realising Henry has absconded with the housekeeping she sets out after him with an axe. Guess what part you play in this happy tale? That's right, you're Henry. Watch out for that axe!



Access or Visa Card holders
please telephone (0344) 27317 (9am - 6pm)

Please add 40p per order for post & packing

Name _____ Address _____

Cosmic Raiders Space Zombies
 Mines of Saturn/Return to Earth Mad Martha

MIKROGEN, Dept PCG, 24 Agar Crescent, Bracknell, Berkshire, RG12 2BK

QUESTION

WHERE CAN I BUY

NEWBRAIN 'A' 32K	FOR	£268.00
NEWBRAIN 'AD' 32K	FOR	£298.00
SINCLAIR ZX81 1K	FOR	£48.00
SINCLAIR SPECTRUM 16K	FOR	£99.00
SINCLAIR SPECTRUM 48K	FOR	£129.00
ORIC-I 48K	FOR	£168.00
SINCLAIR ZX PRINTER	FOR	£39.00
SINCLAIR ZX81 RAM PACK	FOR	£28.50
SEIKOSHA GP-250X PRINTER	FOR	£260.00
SEIKOSHA GP-100A PRINTER	FOR	£215.00
SANYO SCM12H GREEN MONITOR	FOR	£100.00
SANYO SCM12N GREEN MONITOR	FOR	£85.00

CARRIAGE: 1 item £4.00, 2 items £3.50 each, 3 items £3.00 each, 4 or more FREE

ANSWER:-



WHY NOT COME IN AND SEE US
AT OUR NEW SHOP
44 NEW BRIGGATE, LEEDS 1
NEXT TO THE GRAND THEATRE

MICROCELL COMPUTER SYSTEMS

New Brain

APPOINTED STOCKIST

FOR ACCESS PHONE ORDERS, PLEASE RING (0532) 681366

MICROCELL COMPUTER SYSTEMS, 44 NEW BRIGGATE, LEEDS 1, YORKSHIRE

NAME _____		PLEASE SEND ME	
ADDRESS _____		_____	
_____		_____	
_____		_____	
SIGNED _____		TOTAL £ _____	
FOR OUR COMPLETE PRICE LIST		+ CARRIAGE £ _____	
PLEASE TICK <input type="checkbox"/>		TOTAL ENCLOSED £ _____	
PLEASE DEBIT MY ACCESS NO		_____	

SCREEN SCROLL

BBC · VIC 20

104 ➤ So he must dig a hole, wait until a monster falls into it, and then quickly fill the hole in before it can crawl back out. The unfortunate creature falls to the floor below and dies. The 'X' and 'Z' keys control horizontal movement, '.' and '/' vertical, and 'D' and 'F' digging and filling.

In the first frame there are three red monsters, which look like huge tomatoes. If you kill all the monsters, a little tune is played and a new frame appears. This time there are five red tomatoes. From the second frame onwards, any monster who manages to climb out of a hole mutates into a more devastating form. A red one turns green, and a green one turns white. The green and white ones are different, incidentally, and don't look at all like tomatoes.

Green monsters must fall through two vertically aligned holes, and whites through three. If any monster falls on top of another they are both destroyed. In addition to this, the green and white monsters are much smarter than the red ones and will follow you around relentlessly so that it is difficult to find time to dig any holes.

Your oxygen level is shown by a red and yellow bar at the bottom of the screen; this gets progressively shorter throughout the frame. When it reaches red the little man tires and eventually crashes to the floor and dies. This is not a real problem in the first few frames. Later on, when you may find yourself tackling several green and white monsters, it becomes vital.

As have said, Acornsoft's Monsters is high quality. The responses, graphics and sound effects are impeccable, making for one of the best games around. **DO**

GAME: KAKTUS
SUPPLIER: AUDIOGENIC
PRICE: £7.95
MACHINE: VIC 20

The good news is that this is a good, challenging game that makes imaginative use of the Vic's graphics. The bad news is that you need at least an 8k expansion to run it.

A cactus in the centre of the screen is being eaten by wasps and hornets. You are a gopher who must scamper from left to right in a tunnel under the

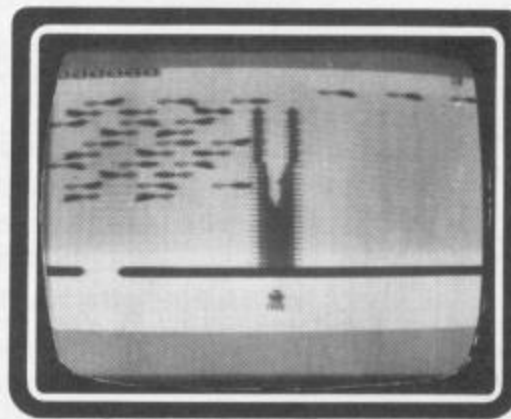

cactus, shooting at the insects to protect it.

When the game begins, the graphics are invariably off centre. You can move them back with the cursor controls – but take care not to move them too far.

There are more than enough hazards in this game to keep you on your toes. The insects release acid drops which can erode the ground over your burrow. If they hit you, you are killed. On the other hand, this does provide extra holes to fire through. As gopher, you are allowed to come out of the burrow. But you

➔ 109

BBC 32K — FINANCIAL GAMES — SPECTRUM 48K



GREAT BRITAIN LTD
You are P.M. and Chancellor of 'Great Britain'
 ACORN USER: "Highly enjoyable"
 ZX COMPUTING: "A challenging game"
 MICRO UPDATE: "A dream for megalomaniacs"

You must select the Party you wish to represent and your aim is to stay in office for as long as possible. You must control inflation and unemployment, maintain the exchange rate, introduce social reforms and stay popular. The game is split into sectors: country profile, shopping basket, budget day, reform opportunities, manifesto, and most important election nights (a telling time).

A COMPLEX GAME THAT YOU WILL NOT TIRE OF IN A HURRY

£5.95



INHERITANCE
Gt. Uncle Arbuthnot is dead. You stand to inherit!!
 PERSONAL COMPUTER WORLD: "Well presented and good value for money"

A 2 part game. Prove your financial acumen in Part 1 by investing wisely at the stock and metal markets; if desperate try the casino or the horse races. If you are successful you will enter the world of big business in Part 2. Find the secret formula for paradise cola; manufacture and market the drink; cope with strikes, fires, frauds, cash shortages, etc. Your ultimate aim is to become a millionaire!

A MAMMOTH GAME PACKED FULL OF FEATURES

£5.95



THE WORLD TRAVEL GAME
A game for 1 or 2 players, full of danger and excitement

Your aim is to collect 6 souvenirs from around the world (from Russia to Falklands) in the shortest possible time. Cope with HIJACKS, STRIKES, THIEVES, CASH SHORTAGES, BANKRUPTCIES, BAD WEATHER, ETC... World Map & full instructions supplied.

BBC ONLY: £6.95 on cassette

★SPECIAL OFFER TO COMPUTER ANSWERS READERS: 2 GAMES FOR £10.95: 3 GAMES FOR £16.95

SIMON W. HESSEL SOFTWARE Dept PCG
 15 Lytham Court, Cardwell Crescent, Sunninghill, Berks
 Telephone: Ascot 25179

24HR DESPATCH — ONE YEAR GUARANTEE — MONEY BACK IF NOT SATISFIED

VIC-20 GAMES

SOFTWARE FROM AMERICA

FROM
£2.65 EACH
IN SIX PAC

FROGGER. Incredible animation in this high performance graphics experience. Frogs, trucks, cars, boats, logs, turtles and lily pads all combine to give your brain a real workout. **£4.95.**

3D MAZE. The ultimate maze game features brain power not fire power. A visually breath-taking 3-dimensional display with a tormenting time factor as the 4th dimension. **£4.75.**

NEW YORK BLITZ. It seems a shame that the only way to safely land your nuclear bomber is to totally obliterate the city, but that's the way it goes. **£4.95.**

ROBOT MOUSE. In this futuristic homicidal game you collect atomic cheese from the floor of the space maze avoiding the mean malfunctioning androids who kill on contact. **£4.50.**

SPACE SHUTTLE. Test your reflexes to the maximum as you attempt to rescue dumb scientists from the lunar surface. Beware of the exploding asteroids in this hectic challenge. **£4.50.**

BUG DIVER. In this highly original game, as a mere beetle you've gotta be fast to avoid the angry carnivorous fish whilst stealing their precious eggs. Their favourite meal is raw beetle. So watch out! **£4.75.**

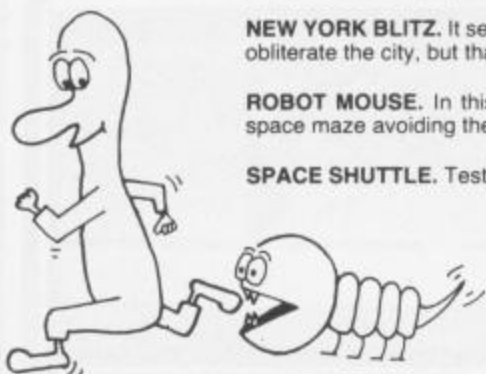

NOW FOR THE FIRST TIME IN UK.....

Six famous arcade quality games use machine code, Hi-res multi-color graphics, exciting sound effects, for any VIC-20, keyboard or joystick.

Available now in UK direct from manufacturer only thru our **super fast mail order service**, or 24hr credit card sales line. All games supplied on cassette with written money back guarantee.

Galactic Software

LAMBROOK RD. SHEPTON BEAUCHAMP. SOMERSET. TA19 0LZ

INTRODUCTORY OFFER

Any 2 games **£7.90**
Any 4 games **£12.95**

ALL 6 GAMES £15.90
(That's only £2.65 each!)

MONEY BACK GUARANTEE

Please rush me copies of (tick box) PCG1

- | | |
|---|--|
| <input type="checkbox"/> FROGGER | <input type="checkbox"/> ROBOT MOUSE |
| <input type="checkbox"/> 3-D MAZE | <input type="checkbox"/> SPACE SHUTTLE |
| <input type="checkbox"/> NEW YORK BLITZ | <input type="checkbox"/> BUG DIVER |

I enclose a cheque/PO for £.....

Name

Address

.....

.....

Tel: 0460 40744



JABBERWOCKY SOFTWARE

We're absolute bottom...in the
boredom stakes!

Fed up with hopping, blasting
and getting nowhere?

Try a game from Jabberwocky
Software...absolutely non-boring!



PAC-MAN



FROGGER



BORING
TEXT
ADVENTURE



SPACE
INVADERS



A
JABBERWOCKY
GAME

OUR SOFTWARE TAKES TIME TO WRITE

ENQUIRIES TO: JABBERWOCKY SOFTWARE,
610 WASHWOOD HEATH ROAD, BIRMINGHAM, B8 2HG. 021-326 6394

SCREEN SCROLL

VIC 20 · ATARI 800 · DRAGON 32

107 are then much more likely to be hit by the acid drops. You are also in danger of being trapped above ground by the occasional mole which may close up the entrance to the burrow.

The game ends when all three lives are gone or when the insects succeed in eroding the base of the cactus so that it falls.

You control the game with a joystick or with easy-to-use keys. Note that the L key, which is used to fire, does not repeat if held down.

Kaktus is sufficiently interesting to interest players who have become bored with variations on the alien attack theme. The graphics are simple but effective, and the mole provides enough of a 'wild' element to add to the general interest. **Karl Dallas**

GAME: PREPPIE

SUPPLIER: ADVENTURE

INTERNATIONAL

MACHINE: ATARI 800

PRICE: £21.99

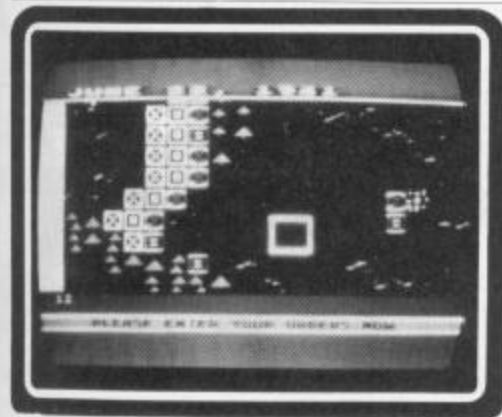

GAME: FROGGER

SUPPLIER: ON-LINE INC

PRICE: £22.75

MACHINE: ATARI 800

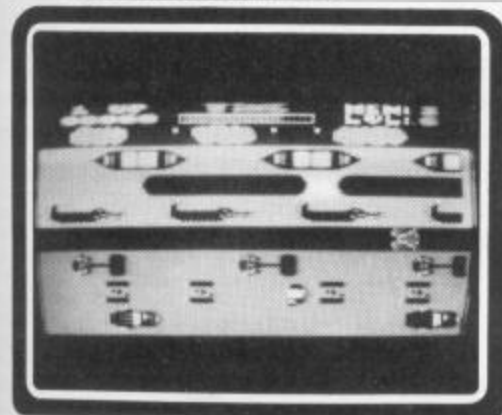

These two are essentially the same game, both being glossy versions of the arcade favourite. Frogger, as you might guess by the name, is the original copyright version, while Preppie is an amusing variation.

For any of you who have yet to sample its delights, Frogger involves manoeuvring a frog first across a busy road and then across a river to reach a

home base at the top of the screen. There are four lanes of traffic on the road, two lanes in each direction, and the speed of this increases as the game progresses. The frog must avoid touching any of the vehicles. On the river the opposite applies, since the frog must leap onto moving streams of logs, turtles and crocodiles to get across. Believe it or not, the frog drowns if it falls in the water.

Things are made more difficult by deadly snakes which wander across the grass between the river and the road, and by various creatures which lie in wait at your home base ready to gobble you up.

The version of Frogger for the Atari is fairly true to its ancestry, except that it is only a one-player game, and each game consists of five frogs. There are 'lady frogs' which wait on logs for your control (which is presumably a gentleman frog) to escort them home. Leaping on top of this frog of the fairer sex allows you to control the happy pair as if they were a single creature. The game has two speeds.

Preppie has a similar layout but with only three lanes of traffic on the road and on the river. In fact, the road is a fairway and is populated with lawnmowers, golf cars and bulldozers. The river starts off with boats only on it, but logs and crocodiles appear later on. Instead of a frog, you control a young student - 'preppie' is a US term for rich spoilt kids who have attended public school. The preppie's name is given in the story which accompanies the game as Wadsworth Overcash.

Because of a bizarre college tradition, Wadsworth has to retrieve golfballs on a very dangerous course. In the first frame there is only one golfball. It lies on the other side of the green, and must be retrieved and carried back to the starting zone. As the game progresses more balls appear. Only one ball can be carried at a time and there is a time limit. Incidentally, instead of a snake threatening you in the central reservation there is a giant frog!

Preppie can be played by one or two players using either one or a pair of joysticks. In both Preppie and Frogger the graphics are superb, and they both include melodic but repetitive tunes. The music can be turned off without losing the other sound effects by pressing SELECT on Frogger or SHIFT and 'M' on Preppie.

I like both of these games, and to be honest there is not much to choose between them. Preppie wins out in terms of presentation, but the long sequences between each term make it slower. It also includes the option of

starting at any level between one and nine, which can be useful once you start to master the game. **DO**

GAME: THE KING (ORIGINALLY SOLD AS DONKEY KONG)

SUPPLIER: MICRODEAL

PRICE: £8

MACHINE: DRAGON 32

This is a version of the curiously named arcade game 'Donkey Kong'. The scenario is an old warehouse where a huge gorilla (clearly a relative of King Kong) is holding a young woman prisoner. Each of the four frames has a different configuration of horizontal girders linked by ladders, with the belligerent ape and his terrified captive at the top.

To start with, your job is simply to climb from the bottom of the screen to the top and rescue the girl. This is complicated by the endless supply of barrels which are consistently hurled at you by the gorilla.

You use the joystick to control a little character who leaps when you press the fire button. Apart from jumping over the barrels, your only defence is to smash them with a mallet, of which two are available at different levels of the screen.

These mallets will destroy the fireballs which wander about the place. But possession of them is temporary, and you cannot climb any ladders while holding one.

If you reach the top on the first frame the scene changes. Now you run over eight 'plugs' symmetrically positioned in the structure. These then disappear - causing the girders to collapse and the gorilla to fall to the floor. This time there are no barrels but plenty of fireballs.

As the game goes on, all sorts of further hazards appear. These include conveyor belts, furnaces and lifts, each demanding a different strategy.

I have always felt this game was one of the most interesting and challenging around, and this version is one of the best you'll find on a micro. It offers two different playing speeds, for one or two players, with the option of a 'practice' game in which you get 12 men instead of three. Full instructions are available at the beginning.

Three copies of The King are included on the tape, giving three colour schemes. The third is in the highest resolution graphics. It is thus less colourful than the other two, but was my favourite, with crisp detailed graphics almost up to the standard of its arcade peer. If I had to recommend one arcade type game to a Dragon owner, this is the one I'd choose. **DO**

UPGRADE YOUR SPECTRUM to 48k

with an EASY TO FIT DELTA-RAM KIT

SPECTRUM

1 £33

SPECTRUM

2 £26

Each kit contains step by step instructions for easy, trouble-free installation within your Spectrum case. Prices include p. & p. and V.A.T.

FREE with every order the UNIQUE DELTA CHIPCHEK Memory Diagnostic Cassette worth £3.50

All you need to do is cut out this coupon, tick the appropriate box, enclose your cheque or Access No. and we'll do the rest.

Name

Address

Postcode

Access Number

Make cheques payable to Servodata Ltd.



DELTA RESEARCH LIMITED
15 Church Street, Basingstoke, Hants RG21 1QG
Tel: 0635 45373



50 games for your micro

For a limited period we are offering 50 first class arcade games for the following micros at a special introductory price

- Spectrum 16/48K£8.99
- Dragon 32£8.99
- Oric 1 48K£8.99
- ZX 81 1K£4.99
- ZX 81 16K.....£5.99

As a further offer to readers of this magazine only we will give a FREE DATA CASSETTE with every tape ordered

Other tapes are:

- Defender 48K Spectrum£2.50
- Sam Slug 16K Spectrum.....£3.00
- Ten Games 16/48K Spectrum ...£3.00

All prices are what you pay, post is free

Please send cheques/PO's to:

ANCO SOFTWARE
25 CORSEWALL STREET, COATBRIDGE ML5 1PX

NEW GAMES FROM

Blaby Computer and Video Games

DRAGON 32

PLANET CONQUEST – land your Freighter Ship safely and then you may proceed to your next solar system. (skill levels etc.) Three screens....£6.95

RAIDERS – In this adventure you must deal with voodoo curses, alligators, ancient traps and hostile natives, leave the large city and travel to the dense jungle of South America.....£5.95

GAMES TAPE 1

SPACE CHASE – Guide your space craft through the Asteroid Belt and dock with your mother ship. Sounds easy, doesn't it!

POKER – Superb graphics

ALIEN (Adventure) – You are the sole survivor on a huge star ship, but you are not alone.....£6.95

SPECTRUM

CONFUSION – You are totally "CONFUSED" and are being attacked from both sides by the most nastiest Aliens known in the universe. 48K M/C.....£4.95

GOLD DIGGER – Dig your way through the mine and collect the gold nuggets on your way and stay ahead of the nugget gnashers. 48K M/C.....£4.95

CHOPPER RESCUE – Scientists are being entombed under radio active waste, can you as a Helicopter Pilot rescue them all in time? 48K M/C.....£5.95

KOSMIC PIRATE – Guide your pirate vessel through the massive fleet of space craft that has encircled the planet Verox and try to steal your essential supplies. 48K.....£5.95

HIGH RISE HARRY – Featuring Harry Highrise and the nasties. Guide Harry along the scaffolding, up the ladder, onto the lifts, but mind the slides! Five different screen 48K.....£5.95

Blaby Computer and Video Games

Crossways House, Lutterworth Road, Blaby, Leicester
Telephone: 0533 773641

No. 1 for the Dragon

The Dragon Dungeon stocks the widest range of software available for the Dragon 32 in the U.K. Over 200 programs in stock, with a further 50 under review. Descriptive catalogue available 50p (refundable first order).

Dragon Owners Club

The Dungeon is also home to the largest Dragon Owners Club, which publishes the monthly magazine 'Dragon's Teeth'. Membership covers Europe, Middle East, Africa, the Far East and New Zealand! Members can save the cost of their subs in software and hardware offers. Annual Subscription £6.00 (£8.00 overseas) or Trial Subscription £3.25 for six months (£4.25 overseas)

The Dragon Dungeon

P.O. Box 4,
Ashbourne,
Derbyshire DE6 1AQ
Telephone: Ashbourne 44626



SCREEN SCROLL

DRAGON 32 · ATARI · IBM PC

109 **GAME: KATERPILLAR ATTACK**
SUPPLIER: MICRODEAL
PRICE: £8
MACHINE: DRAGON 32
(VERSION ALSO AVAILABLE FOR ATARI)

No prizes for guessing that this is the Dragon version of Centipede, the copyright of which is one of those held by Atari UK. It is licensed from an American outfit called Tom Mix Software.

You move a small oval base around the bottom of the screen while firing upwards at long centipedes/caterpillars, each of whose segments has a life of its own. The playing field is scattered with mushrooms which take four shots to destroy. New mushrooms appear whenever you hit a caterpillar segment. They also appear in the wake of the creatures (fleas in the original but described as spiders in the introduction to Katerpillar) that occasionally hurtle down at you from the top of the screen.

Katerpillar is fast with good graphics and sound. It isn't as exciting as the Atari cartridge version, but is less than

a third of the price. My only major criticism is that the base will only move very slightly in a vertical direction so that it is virtually impossible to escape the caterpillar segments when they reach the bottom. **DO**

GAME: FLIGHT SIMULATOR
SUPPLIER: MICROSOFT
PRICE: £35.00
MACHINE: IBM PC (64K)

Far more than just a game, the Microsoft simulator is realistic enough to qualify as a serious training aid for prospective pilots or those with a passion for flying but no cash to indulge it.

You can select a vast number of routes about the North American continent. There are 22 detailed airport layouts to take off from or land at, in weather conditions ranging from daylight with no wind and not a cloud in the sky through to pitch darkness and solid clouds with a tornado raging.

This program is for the dedicated, for people who are prepared to spend many hours in the 'cockpit' learning how to fly. Its long-term appeal for

them is undoubted, but less serious flyers could soon admit defeat.

There is a 100-page instruction manual which is easy to read and understand. Illustrations and maps explain the aircraft controls and instruments clearly. The instrumentation, too, is excellent, with a generally rapid response to the controls. With so many variables for the pilot to set, it can be tailored to fit just about any level of skill.

Unfortunately, with such a large area of the world to cover and display, the resolution gives a rather jerky and lumpy appearance. The colours are not quite realistic, and although the graphics are excellent, I have to fault the sound effects.

If you get tired of serious flying, a bonus in this package is British Ace, a World War I dogfight game. In this, you must shoot down at least five enemy fighters - with differing capabilities - and bomb aerodromes and factories. You battle it out in real time, so it is advisable to learn to handle your aircraft using the flight simulator program before tackling this game. This is one situation where learning on the job will not do. **Nigel Cross**

ZX81

Games from ORWIN SOFTWARE

WHAT THEY SAID ABOUT CASSETTE 4

"quantity as well as quality" *Sinclair User*, Oct '82

"If each game was on a separate tape and selling for £5 each I would still recommend them" *ZX Computing*, Oct/Nov '82

"Easy to operate, graphically impressive and good value for money." *The Times*, 11th Dec '82

Now we have collected another set of 8 excellent games for Cassette 5

CASSETTE 4 8 games for 16K ZX81 £6

ZX-SCRAMBLE (machine code)

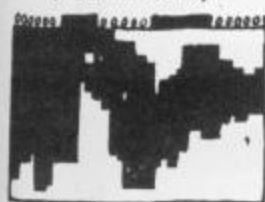

With 3 stages. Bomb and shoot your way through the fortified caves.

GALAXY INVADERS (machine code) Fleets of swooping and diving alien craft to fight off.

SNAKEBITE (machine code) Eat the snake before it eats you. Variable speed. (Very fast at top speed.)

LIFE (machine code) A ZX81 version of the well known game.

3D TIC-TAC-TOE (Basic) Played on a 4 x 4 x 4 board, this is a game for the brain. It is very hard to beat the computer at it.

GUNFIGHT (machine code) Western style shoot-out between 2 players or against the computer.

FUNGALOID (machine code) Bomb the Fungaloids before they grow to the sky or shoot you down.

INVADERS (machine code) 49 aliens and random flying saucers to shoot down.

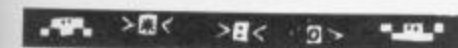

7 of the 8 games are in machine code because it is much faster than Basic. Some of these games were previously available from J. Steadman.

CASSETTE 5 8 games for 16K ZX81 £6

SPACE RESCUE (machine code)



BYTE-MAN (machine code)

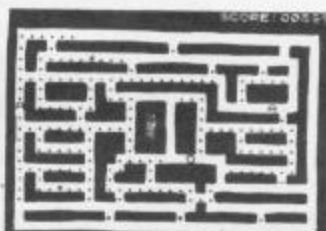

BLITZ (machine code)



PLANETOIDS (machine code) Move your ship and fire missiles in 8 directions to avoid and shoot down the large planetoids and small fliers and bouncers. Rotate left, rotate right, move, fire and hyperspace controls.

DODGEMS (machine code) Dodge the computer's car while eating the dots.

DRAUGHTS (machine code) Play against the computer. Three skill levels.

MERCHANT (Basic) Make your fortune on trading voyages in the Mediterranean and beyond.

7 of the 8 games are in machine code because it is much faster than Basic.

SPACE RESCUE and BYTE-MAN were previously available from Mindseye.

CASSETTE 1, eleven 1K programs £3.80
(including 7 in machine code)

CASSETTE 2, ten 16K games in Basic £5

CASSETTE 3, eight 16K programs £5
(including 1 in machine code)

Please make your cheques payable to ORWIN SOFTWARE and send your order to:
 ORWIN SOFTWARE, Dept PCG, 26 Brownlow Road, Harlesden, London NW10 9QL

SEND SAE FOR DETAILED CATALOGUE
 SPECTRUM PROGRAMS WANTED

REVIEWS

111

INDEX

LIST OF SUPPLIERS ADVERTISING IN THIS ISSUE

Supplier	page	Supplier	page
Abersoft	70	Micromail Ltd	100
Acornsoft	4	Micronet 800	92
Acorn User Exhibition	23	Mr Chip	40
Addison-Wesley Publishers	65	New Generation Software	98
Algray	63	Nottingdale Technology Centre	78
Anco Software	110	Oric Software	85
Anirog Software	29	Orwin	111
Arcade Computers	66	Oxford Computer Publishing Ltd	46
Audiogenic Ltd	68	Pancom	36
Bamby Software	16	Peaksoft	84
Blaby Computer & Video Games	110	Personal Computer World	14
Buffer Micro Ltd	102	Phoenix Publishing Associates	46
Cambridge Computing	28	Plus 80	69
Carnell Software	6	Postern Ltd	inside front
CDS Micro Systems	64	Quest Microsoftware	105
Channel 8 Software	26	Quicksilva	outside back
Cheetah Marketing Ltd	30	Salamander Software	41
Crash Micro	6	SBD Software	103
Delta Research Ltd	110	Shards Software	105
Digital Fantasia	20	Richard Shepherd Software	96
DJL Software	94	Shiva Publishing Ltd	48
The Dragon Dungeon	110	Silica Shop	76-77
Duckworth	46	Softek Software	13
Efficient Chips	72	Software Centre	42-45
Flightlink Control Ltd	66	Software Supermrket	31
Frost Supplies	12	Solo Software	34
Galactic Software	108	Spire Computer Services	46
Gamer	39	Startech	99, inside back
Gem Software	74	Superior Software	87
S. Hessel Software	107	Supersoft	62
HiSoft	70	Tansoft Ltd	82
HiTech Microsoft	65	Tevward Microtech Ltd	100
IJK Software Ltd	49	Thorn EMI	24-25
Interceptor Micro's	80	Trionic Ltd	102
Jabberwocky Software	108	Twilstar Computers Ltd	12
JCB MicroSystems	74	Ultimate Play The Game	88
Kempston Micro Electronics	84	UTS	62
Laserbug	74	Video Software	36
Linsac	78	Voltmace Ltd	70
Llamasoft Computer Software	90-91	Vulcan Electronics	65
Lyversoft	95	Watson Software	62
Microcell Computer Systems	106	Wintersoft Software	37
Microgen	105		

AFTER THOUGHTS

Solution to puzzle on page 27

Base to New York/New
York to Base/Base to Cairo;
Base to Rome/Rome to
Base/Base to Cairo;
Base to London/London to
Base/Base to Sydney

Solution to puzzle on page 28

2C and 4D

Solution to puzzle on page 30

Title C. Sequence starts in
top left corner, works down
the first column, up the
next, down the third, etc.
The three symbols – circle,
square and triangle – are
repeated in white and black.
Each appears once, then
twice, then thrice, etc.

STARTTECH

Absolutely
the lowest
prices!

computer apple computer apple computer apple computer apple computer apple computer



BEAM UP A BARGAIN, SCOTTY!

NEW

pfs:TM

**THE INFORMATION
MANAGEMENT SYSTEM
WRITTEN IN PASCAL**

A powerful, fast, and user-friendly database accounting system now available for your Apple at an incredibly low price.

PFS: DATABASE
£59.95

PFS: REPORT
£49.95

NEW
LOW PRICES!

£5 OFF!

16K RAM CARDS
(Pascal CPM: Computer Stop)

~~WAS £49.95~~ **NOW £44.95**

NEW
LOW PRICES!

£5 OFF!

ALL VISI PRICES

	WAS	NOW		WAS	NOW
VISICALC, VISICORP	£105.00	£100.00	VISISCHEDULE, VISICORP	£149.95	£144.95
VISIDEX, VISICORP	£127.95	£122.95	VISITERM, VISICORP	£53.95	£48.95
VISIFACTORY, MICRO	£37.95	£32.95	VISITREND/VISILOT, VISICORP	£148.95	£143.95
VISIFILE, VISICORP	£120.95	£115.95	DESK TOP PLAN 11: PERSONAL SOFTWARE	£131.95	£126.95
VISILOT, VISICORP	£98.95	£93.95			

NEW
LOW PRICES!

**MICRO PRO
WORDSTAR**
SIMPLY THE BEST

~~WAS £149.95~~ **NOW £145.95**

ADVENTURE

Adventure (Microsoft): Microsoft	£13.95
Ali Baba + 40 Thieves: Quality Software	£18.95
Castle Wolfenstein: Muse	£13.95
Dark Forest: Sirius Software	£15.95
Wizard & Princess: On Line	£14.95
Soft Porn Adventure: On Line	£13.95
Space Adventure: Siera Software	£14.95
Time Zone: On Line	£45.95
Zork 3: Infocom	£19.95
Zork 2: Infocom	£19.95

BOOK

Beaneath Apple Dos: Quality Software	£9.95
--------------------------------------	-------

BUSINESS

Address Book (List) Muse	£23.95
Data Factory: Micro Lab	£72.95
Data Factory 5.0: Micro Lab	£139.95
DB Master: Stoneware	£104.95
Magic Window (WP): Artsci	£46.95
Easywriter Pro: Info Unlimited	£115.95
Easy Mailer: Info Unlimited	£87.95
Invoice Factory: Micro Lab	£108.95
DB Utility Packs: Stoneware	£47.95

GRAPHICS UTILITY

Arcade Machine: Broderbund	£21.95
A26E1 Graphics: Sub Logic	£32.95
Hi-Res Secrets: Avant Garde	£60.95

HI-RES ACTION

Alien Rain: Broderbund	£13.95
Anti Ballistic Missile: Muse	£12.95
Apple Panic: Broderbund	£14.95
Flight Simulator: Sub Logic	£18.95
Frogger: On Line	£17.95
Gorgon: Sirius Software	£17.95

Tumble Bug: Datasoft	£17.95
Space Eggs: Sirius Software	£12.95
Space Quarks: Broderbund	£13.95
Swashbuckler: Datamost	£16.95
Hi-Res Soccer: On Line	£13.95

LANGUAGE

Asm Lang: Development Sys: Hayden	£24.95
Expediter 11 Compiler: On Line	£39.95
Fourth 11 (Language): Softape	£31.95
Lisa 2-5 6502 Assembler: On Line	£45.95

STRATEGY GAME

Air Traffic Controller: Avant Garde	£7.95
Robot Wars: Muse	£18.95
Tigers In The Snow: Strategic Simulations	£17.95

UTILITY

Back It Up: Sensible Software	£30.95
Bag of Tricks: Quality Software	£20.95
Deadly Secrets: Broderbund	£17.95
Dossource 3.3 Dos Listing: Lazer	£18.95
Program Line Editor: Synergistic Software	£18.95

HARDWARE

Excel-9 (6809 With "Flex"): ESD Laboratory Co. Ltd	£164.95
23 Key Keypad (Visicalc): Keyboard Company	£101.95
Omnivision 80/24 Video: Computer Stop	£144.95
U Term 80/24 Video Card: U Micros	£151.95
Z80 Softcard: Microsoft	£203.95
10 Meg Hard Disk System: Computer Stop	£1644.95

Z80 CPM (Z80 Softcard Required)

Wordstar: Micropro	£137.95
D Base 11 Manual: Ashton Tate	£33.95
Aids Z80, 8080 Assembler: Microsoft	£57.95
Bstam Micro To Micro: Byrom	£108.95

Please send me:

I enclose cheque/P.O. for

Name:

Address:

Please add V.A.T. to all orders.
Postage paid in U.K. Allow 30 days for
delivery. Access & Barclaycard orders
welcome on 051-256 8244

PCW.1.83

STARTTECH

63 Lisburn Lane,
Tuebrook, Liverpool L13 9AF

SPECTRUM SOFTWARE

TIME-GATE
4D Space/time adventure in fast moving graphics. 48K.

Author: **John Hollis**
THE CHESS PLAYER

With Speech and personality. 48K.

Author: **Martin Wren-Hilton**
METEOR STORM

With speech and Hi Res Graphics. 16K or 48K.

Author: **John Hollis**
SPACE INTRUDERS

With mutants and Hi Res Graphics. 16K or 48K.

Author: **John Hollis**
EASYSPEAK

Add speech or music to your programs. 48K.

Author: **John Hollis**
MINED-OUT

With 9 levels of minefield. 48K.

Author: **Ian Andrew**
SOFTWARE FOR THE ZX81 WITH 16K RAM

QS ASTEROIDS
...very good...
...addictive game!
(C & VG).

Author: **John Hollis**
QS DEFENDA

...better than any other arcade game I've seen.
(Sync).

Author: **Nick Lambert**
QS SCRAMBLE

...amazing, fantastic!
(PC.W).

Author: **Dave Edwards**
QS INVADERS

...just like the real thing!
(C & VG).

Author: **Dave Edwards**
MUNCHEES

Features 1 to 4 Ghosts, 3 Munchees, Power pills.

Author: **A. Laird**
GALAXIANS & GLOOPS

Features two types of swooping Galaxian.

Author: **T. Beckwith**
CROAKA-CRAWLA

With Frogs, Lornies, Logs, Crocodiles, Turtles, Flies.

Author: **John Field**

SPECTRUM & ZX81 GAMES FROM QUICKSILVA

A WHOLE GALAXY OF ACTION AT YOUR FINGERTIPS

NEW RELEASES FOR THE ZX81 & SPECTRUM

SPECTRUM FRENZY

Arcade action
Features: Full colour hi-res graphics, sound, high score table, hold feature, 5 levels of robots, Evil Orville the minelayer, exploding pods, progressive difficulty, attract mode.

Author: **David Shea**

ASTRO BLASTER

Arcade action

Features: Full attract mode, 5 attack waves, 15 levels of difficulty, rapid fire, meteor storms, changing aliens, plasma bolts, killer bombs, full colour hi-res graphics, full sound.

Author: **John Edwards**

16K or 48K Spectrum

A WORD PROCESSOR

Features: Menu driven prompts given at all times. Drastic commands — e.g. Clear Text — are automatically questioned. Load/save commands... all text justified on screen as well as printer.

Author: **P. Baker**

48K Spectrum

PIXEL GAMES FOR THE ZX81 WITH 16K RAM

TRADER
A trilogy of 16K programs that combine to give an epic 48K graphic adventure. As a galactic trader, you deal with some very bizarre customers indeed.

STOP PRESS
Trader now available for the Spectrum £9.95

SUBSPACE STRIKER/ZOR

With your deadly antimat torpedoes, you unleash havoc in the Federation's Spacelanes.

STARQUEST/ENCOUNTER

With the help of your onboard computer you seek a habitable planet amidst the perils of deep space.

ZX81 GAMES OCEAN TRADER

An adventure set in the 19th Century.

You own and captain a vessel, sail between 5 ports and deal in coal and whisky; with storms, pirates, sea mist and vessels adrift.

Author: **A. Morgan**
ZX81 with 16K RAM

COSMIC GUERRILLA

Arcade action
Fast m/c action, will drive QS sound and character boards, responsive controls, high score tables.

Author: **C. K. Tame**
ZX81 with 16K RAM

3D BLACK STAR

Arcade action
Features: Fast 3D graphics, fast scoring, four types of target, Eight instrument displays, warp drive, resurging aliens, time limit, 17 levels of progressive difficulty, high score table.

Author: **M. Sudworth**
ZX81 with 16K RAM

DAMPER & GLOOPER

Arcade action
Features: Fast action, 5 dampers increase to 6 on later phases, 3 lives plus bonus lives, ever increasing speed, high score, stall frame features, spiral clear at end of games, bonus phase worth 5000 pts., high score save and display.

Author: **R. Crane**
ZX81 with 16K RAM

PIONEER TRAIL

A western adventure
Features: 20 levels of play. "Mind Game" plus shooting rifle speed uses all keys and is measured against the players personal average response. This game is based on historical data.

Author: **Marion Stubbs**
ZX81 with 16K RAM
Quicksilva Limited, Palmerston Park House, 13, Palmerston Road, Southampton SO1 1LL. Telephone: (0703) 20169

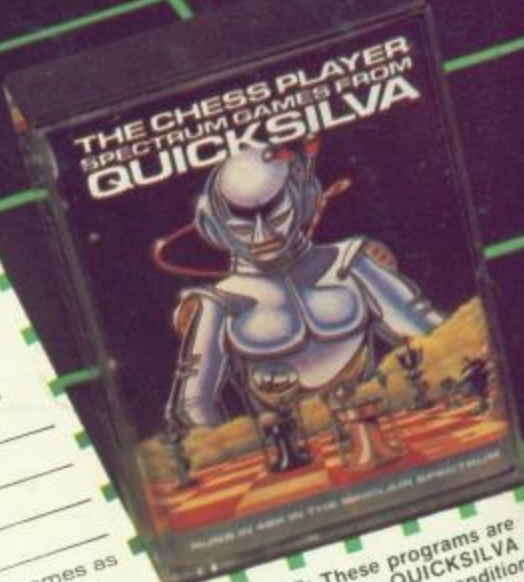

- SPECTRUM GAMES**
- Time Gate £6.95
 - Frenzy 16K £4.95
 - Mined-Out £4.95
 - Easyspeak £4.95
 - Astro Blaster £4.95
 - Meteor Storm £6.95
 - The Chess Player £4.95
 - Space Intruders £4.95
 - A Word Processor £5.95
 - Trader 48K £9.95

- PIXEL GAMES FOR ZX81**
- Trader £9.95
 - Subspace Striker & Zor £3.95
 - Starquest & Encounter £3.95

- ZX81 GAMES**
- QS Asteroids £3.95
 - QS Defenda £3.95
 - QS Scramble £3.95
 - QS Invaders £3.95
 - Croaka-Crawla £4.95
 - Galaxians & Gloops £3.95
 - Munchees £3.95
 - Black Star £4.95
 - Cosmic Guerilla £3.95
 - Damper & Glooper £4.95
 - Ocean Trader £3.95
 - Pioneer Trail £3.95

Cheque payable to Quicksilva

Name _____ Address _____

Please send me the games as ticked. Supplied on Cassette.

WARNING: These programs are sold according to QUICKSILVA Ltd's terms of trade and conditions of sale. Copies of which are available on request.

Send order to: Quicksilva Limited, Palmerston Park House, 13, Palmerston Road, Southampton.