

ACORN USER

BBC MICRO • ELECTRON • ATOM

JUNE 1984 £1

Nine tests for
your monitor

Build your own
computer rack

Rotating designs:
BBC and Electron

Diagnosing
program listings

How does your
micro work?

Software: the
business end



HOME



EDUCATION

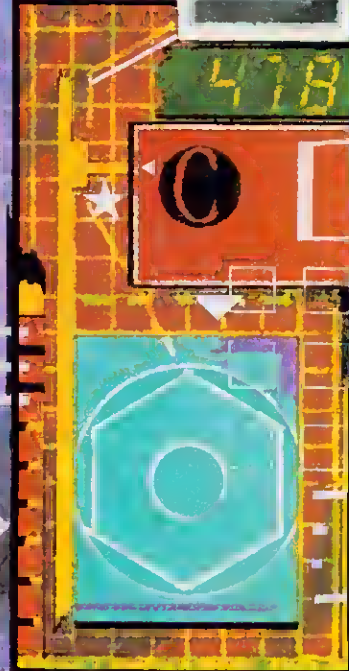

GRAPHICS

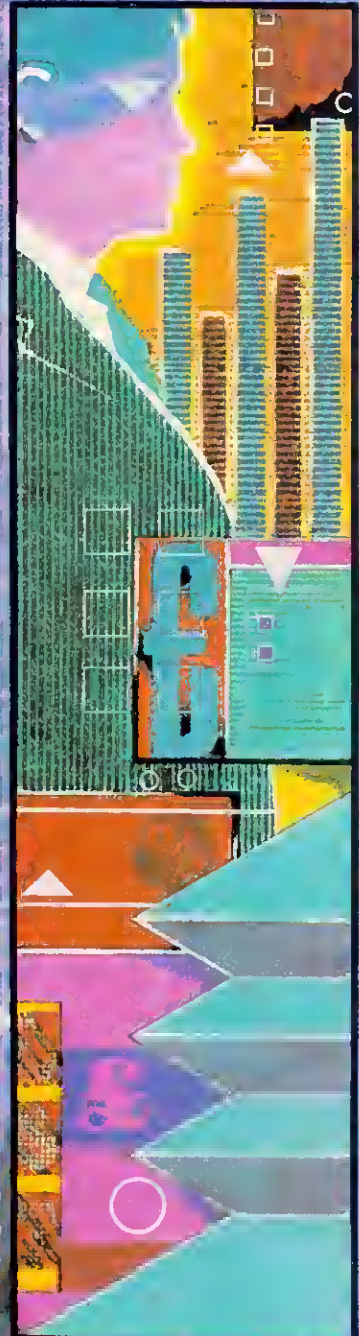

BUSINESS

BBC GROWS INTO BUSINESS

DESIGNED WITH PROGRESS IN MIND



An example of superior technology, total reliability and outstanding performance, combined to produce the LVL Disk Drive Family.

Truly professional units designed to work with the BBC
Microcomputer.

- Compatible with the BBC drive units. Disks are interchangeable with those formatted on the BBC Drives.
- Operates either from the BBC DOS or the LVL Double Density DOS Kit or from the optional Z80 and CP/M.
- Supplied complete with all necessary connecting leads, utility disk and full operating manual.
- Available from all LVL Dealers.
- Powered from your BBC model B computer.
- Self powered version also available (LVL 02P)



Scientific House, Bridge Street, Sandiacre, Nottingham
NG10 5BA Tel: 5602 394000

LORDS OF TIME

Joins our range of acclaimed pure-text puzzle adventures, at £9.90, for:

BBC 32K COMMODORE 64 SPECTRUM 48K LYNX 48K NASCOM 32K ORIC 48K ATARI 32K

ADVENTURE REVIEWS

"Adventures which have a fast response time, are spectacular in the amount of detail and number of locations, and are available to cassette owners... Simply smashing!"

— *Soft, Sept 83*

"Colossal Adventure is included in Practical Computing's top ten games choice for 1983: "Poetic, moving and tough as hell."

— *PC, Dec 83*

"Colossal Adventure... For once here's a program that lives up to its name... a masterful feat. Thoroughly recommended"

— *Computer Choice, Dec 83*

"Colossal Adventure is one of the best in its class. I would recommend it to any adventurer."

— *Acorn User, Feb 84*

"Adventure Quest... This has always been one of the best adventures for me as it seems to contain the lot. In all it took me about eight months to solve."

— *PCW, 18th Jan 84*

"To sum up, Adventure Quest is a wonderful program, fast, exciting and challenging. If you like adventures then this one is for you"

— *NILUG issue 1.3*

"Colossal Adventure is simply superb... For those who want to move onto another adventure of similar high quality, Dungeon Adventure is recommended. With more than 200 locations, 700 messages and 100 objects it will tease and delight!"

— *Educational Computing, Nov 83*



ADVENTURE REVIEWS

"Colossal Adventure... undoubtedly the best Adventure game around. Level 9 Computing have worked wonders to cram all this into 32K... Finally Dungeon Adventure, last but by no means least. This is the best of the lot - a truly massive adventure - you'll have to play it yourselves to believe it."

— *CBM 64 Users Club Newsletter*

"The puzzles are logical and the program is enthralling. Snowball is well worth the money which, for a computer program, is a high recommendation."

— *Micro Adventurer, Dec 83*

"Snowball... As in all Level 9's adventures, the real pleasure comes not from scoring points but in exploring the world in which the game is set and learning about its denizens... this program goes to prove that the mental pictures conjured up by a good textual adventure can be far more vivid than the graphics available on home computers."

— *Which Micro?, Feb 84*

"Lords of Time. This program, written by newcomer Sue Gazzard, joins my favourite series and is an extremely good addition to Level 9's consistently good catalogue... As we have come to expect from Level 9, the program is executed with wonderful style - none of those boring "You can't do that" messages! Highly recommended."

— *PCW, 1st Feb 84*

MIDDLE EARTH ADVENTURES

1: COLOSSAL ADVENTURE

A complete, full size version of the classic mainframe game "Adventure" with 70 bonus locations added.

2: ADVENTURE QUEST

Centuries have passed since the time of Colossal Adventure and evil armies have invaded The Land. The way is long and dangerous, but with cunning you can overcome all obstacles on the way to the Black Tower, source of their demonic power, and destroy it

3: DUNGEON ADVENTURE

The trilogy is completed by this superb adventure, set in the Dungeons beneath the shattered Black Tower. A sense of humour is essential!

THE FIRST SILICON DREAM ADVENTURE

1: SNOWBALL

The first of Pete Austin's second trilogy. The giant colony starship, Snowball 9, has been sabotaged and is heading for the sun in this massive game with 7000 locations.

THE LORDS OF TIME SAGA

7: LORDS OF TIME

Our congratulations to Sue Gazzard for her super design for this new time travel adventure through the ages of world history. Chill to the Ice-age, go romin' with Caesar's legions, shed light on the Dark Ages, etc.

Price: £9.90 each (inclusive)

Level 9 adventures are available from good computer shops, or mail-order from us at no extra charge. Please send order, or SAE for catalogue, to.

LEVEL 9 COMPUTING

Dept A, 229 Hughenden Road,
High Wycombe, Bucks HP13 5PG
Please describe your computer

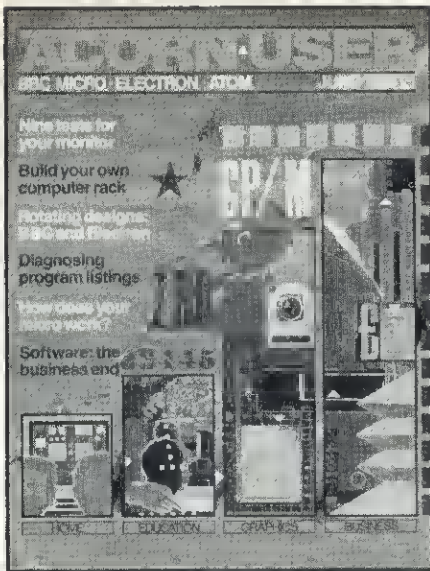

Front cover illustration by Will Hill

Editor

Tony Quinn

Production editor

Keith Parish

Editorial assistant

Kitty Milne

Art editor

Nigel Wingrove

Publishing director

Michael Potter

Editorial director

Christopher Ward

Published by Redwood Publishing, 68 Long Acre, London WC2E 9JH. Tel: 01-836 2441. **Typesetting & Artwork** Vantage Group, Wardour St., London W1. **Production** Aquarius Print and Design Ltd., Scala St., London W1. **Printed in Great Britain** by Watmoughs Ltd, Bradford. **Advertising Agents** Computer Marketplace Ltd, 20 Orange St, London WC2H 7ED. Tel: 01-930 1612. **Distributors to the News Trade** Comag, Tavistock Rd, West Drayton, Middlesex UB7 7QE. Tel: (0895) 44405. **Subscriptions** Subs Dept, Redwood Publishing, 68 Long Acre, London WC2E 9JH. Tel: 01-836 2441.

© Redwood Publishing 1984

All rights reserved. No part of this publication may be reproduced without prior written permission of the publisher. The publisher cannot accept any responsibility for claims or errors in articles, programs or advertisements published. The opinions expressed on the pages of this magazine are those of the authors and do not necessarily represent those of the publisher, Acorn Computers Ltd, or Acornsoft Ltd. Acorn, Acornsoft, and the Acorn symbol are the registered trademarks of Acorn Computers Ltd and Acornsoft Ltd.

Annual subscription rates:

UK	£15
Europe	£18
Middle East	£20
The Americas and Africa	£22
Rest of the World	£24

These prices are inclusive of post and packing for 12 issues.

Features

Z80 Second Processor 26

We report on the Z80 business bundle

Forth 51

Paul Garfield stacks up some reasons why this language could make a useful extension to your programming repertoire

On the Cards 61

Alan Samuels picks a card game to demonstrate how graphics can brighten up the play

Soft Pottery 67

Malcolm Banthorpe conducts a pottery lesson

Speed & Space 77

How to quicken your pace and save memory space in Basic programming, by Gary Smallridge

Tape Loader 81

An accurate and rapid search and load routine for Electron and Beeb from John Bexon

How it Works I 89

In a new series, Paul Beverley takes the lid off the Beeb and Electron to investigate their inner workings. In Part I he monitors a program as it runs

Train Game 96

Martin Phillips puts you on the right track

Business 102

Barry Pickles eases the forward-thinking businessman gently into office computerisation – *Plus* reviews of business packages from Acornsoft and Gemini

Education 111

Jonathan Read airs his views on how the micro should be used in adult literacy classes, and Martin Wallis tests a mixed suite of mathematics programs

Atom Lister 121

Manipulating and dumping Atom programs on the BBC micro has many advantages, says Vincent Fojut

Atom Forum 124

Barry Pickles presents the new 6502 instruction set – *Plus* AtomBasic bugs, random numbers, sideways scrolling

Reviews

Screen Test 134

Chris Drage subjects four monitors to the close scrutiny of his gruelling test program

Games 139

Under review this month: *Lunar Rescue*, *JCB Digger*, *Ghouls* and *Dodg'em*

Printers 143

George Hill tries the Canon PW1080A NLQ and the Sanple Daisy Step 2000 economy daisywheel

New Books 153

Our verdict on three puzzle compendiums, David Levy's *Computer Gamesmanship* and *BBC Basic for Beginners*

Adventures 154

How does Stuart Menges make out in *Lost City* and *Colditz Adventure*?

EPROM programmer 159

Bruce Smith blows his own on Softlife's EPROM programmer

YELLOW PAGES EXTRA

Hints & Tips	I
Beeb Forum	III
Card Graphics	IV
3D Graphics	V
Tape Loader	VI
Hardware	VII
Screen Test	VIII



Regulars

The News	7
Electron ROMs, Healthnet for doctors, Micronet shake-up, IBM compatibility for BBC	
Top 20 software	13
'Serious' games ahead! <i>Plus</i> —what's new for the Elk?	
Acorn Abuser's Diary	15
Tig the pig, Yossa and skeletons in this month's scurrilous micro cupboard	
News Feature	18
Simon Elsom on what copyright means for micros	
Hints & Tips	33
Roll up your sleeves for Martin Phillips' projects to build your own computer tidy and carrycase	
Techniques	47
Useful structures for disc-stored databases are balanced binary trees. Stan Froco explains these 'B-trees'	
Beeb Forum	55
Guest editor George Hill comes up with a tape-to-disc transfer for all types of programs	
Software offers	75
Two good-value <i>Acorn User</i> games — <i>Plus</i> all the listings in this issue on cassette!	
Competition	131
Win a Sidewise ROM board and four ROMs (or other prizes) in Simon Dally's Riddle of the Ritz	
Letters	161
Service from software houses, piracy, 'sideways' copying, programs for the aged, testing monitors, and disc standards	
Readers' free ads	171
Small ads	175

IN THIS ISSUE ...

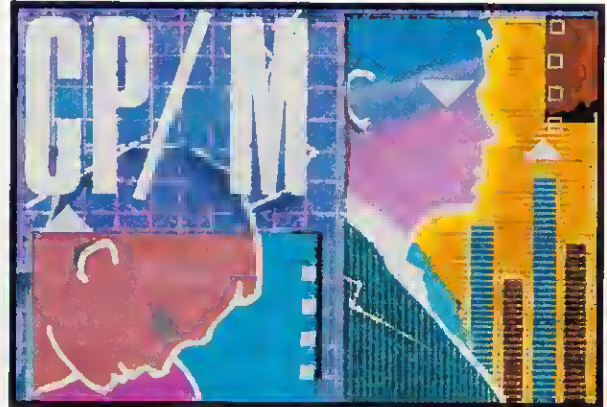

Z80 bundle
Acorn's Z80 Second Processor could put the CP/M world at your feet. We report on what you get for your £300

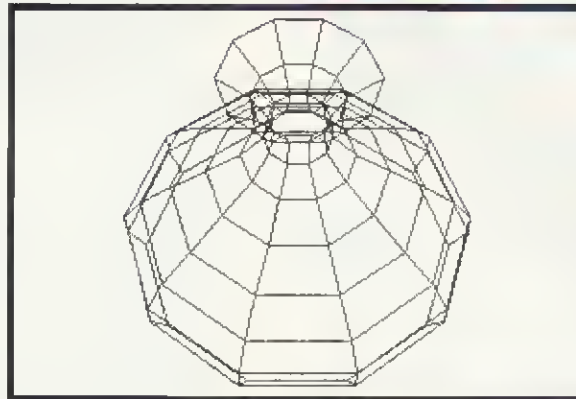

Soft Pottery
Jugs and vases galore created by rotating lines, and then coloured in to make weird and wonderful shapes. Malcolm Bantorpe is the master potter



Printers
Can a dot matrix hope to give letter-quality print? George Hill compares the NLQ Canon with a Sanpie daisywheel pictured right

NEXT MONTH ...

Communications:
Portable micros, bulletin boards and electronic mail
Colour printing:
State of the art colour from Canon's inkjet printer — as shown here
IEEE reviewed:
Three competing interfaces for the more serious Beeb user
First byte:
NEW! A regular feature to develop your computer skills starting from the time you open the box



PRINTERS

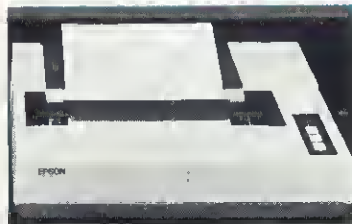

We have a range of printers that will meet most requirements.

EPSON—the high quality dot-matrix printers that set the standard in the industry—versatile printers that provide the optimum in performance & reliability. The RX80/FT provides all standard printing & graphic functions, (single

sheets & perforated paper), with the de-luxe FX80 giving in addition proportional printing, italics, programmable characters etc. The FX100 also allows the use of 15" wide paper.

The **JUKI** daisywheel provides a quality normally found in printers costing far more. Printer cables, interfaces, ribbons, paper etc. are all normally available from stock.

NEW
Epson DX100
Daisy Wheel
in stock.

TORCH Z80 DISC PACK

The proven upgrade for the BBC Micro. Comprising 2 x 400K disc drive, Z80 processor with 64K of memory, and a CP/M compatible operating system, it opens up the vast range of CP/M software, including advanced languages, scientific and business applications. The system is supplied complete with the PERFECT software range including PERFECT WRITER, PERFECT SPELLER, PERFECT CALC, and PERFECT FILE. Full TORCHNET software is also supplied allowing sophisticated networking between other units. This will allow access to information, and communication, between up to 254 upgraded BBCs.

NEW TORCH Z80 PACK PRICE £699.
SOFTWARE PACKAGE INCLUDES Z80 BASIC

Phone for details about the 20Mbyte Hard Disc Pack, and the 68000 Hard Disc Pack with UNIX Operating System.

NOW AVAILABLE — The TORCH Z80 SECOND PROCESSOR CARD — for those who already have suitable disc drives. The card is supplied with all the free software, as detailed above, presenting a very attractive package. £299.

RH LIGHTPEN

The Acorn-approved superior design, with a programmable 'push-tip' switch, status indicator LED and an interface box. Supplied complete with manual, full software and basic demo programs. £39(c). Colour graphics. Cassette £8.65(d) Disc £10(d).

MICROTEXT

Developed by the National Physical Laboratory, is a program-ming system designed to simplify the production of a wide range of man-computer dialogues. Using MICROTEXT, an expert in any field can construct their own complete courses of computer-based instructional material. Applications include interviewing systems, teaching packages, training courses and interactive demonstrations and simulation. Cassette £43.35(c) Disc £52(c).

GRAFPAD

A low cost graphic-tablet offering the performance and durability required for the business, industrial and educational user. It is small, accurate & reliable. Working area: 240 x 192mm + Menu area. £125 plus CAD program.

TELETEXT

Converts your BBC into a fully fledged Teletext Terminal. In addition to normal reception of Teletext pages, it is able to 'download' software as well as saving standard pages on any of the four TV channels. £196.

ACORN COMPUTER SYSTEMS

BBC Model B	£348.00a
BBC Model B + Econet	£389.00a
BBC Model B + DFS	£429.00a
BBC Model B + DFS + Econet	£470.00a
Acorn Electron	£175.00a
BBC Teletext Receiver	£196.00a
BBC Dust Cover	£4.00d
Pair of Joysticks	£11.70c

TORCH Z80 SYSTEM

TORCH Z80 Disk Pack	£730.00a
TORCH Z80 2nd Processor Card	£375.00a

UPGRADE KITS

A to B Upgrade Kit	£75.00d
Installation	£15.00
DFS Kit	£95.00d
Installation	£15.00
Econet Kit	£55.00d
Installation	£25.00
Speech Kit	£47.00d
Installation	£10.00

ECONET ACCESSORIES

Printer Server Rom	£41.00c
File Server Level 1	£86.00c
File Server Level 2	£216.00b
Clock + 2 Terminators	£92.00b
Econet User Guide	£10.00d

BBC FIRMWARE

1.2 Operating System	£7.50d
Basic II Rom	£32.00d
View Word Processor Rom	£52.00c
Wordwise W/P Rom	£34.00c
Beebep W/P Rom	£38.00c
BCPL ROM + Disc	£87.00b
Disc Doctor Utility Rom	£28.00c
Termi Emulator Rom	£28.00c
ULTRACALC Rom (BBC Publications)	£65.00c
Gremlin debug Rom	£28.00c
Computer Concepts Graphics Rom	£28.00c
EXMON	£20.00d
TOOL KIT	£20.00d
Printmaster Rom	£30.00c
Communicator Rom	£59.00c

BBC ANCILLARY HARDWARE

EPROM Programmer	£89.00b
Smartmouth Speech Synthesiser	£37.00b
RH Light Pen	£39.50b
"Time-Warp" Real-Time	
Clock/Calendar	£29.00b
ACORN IEEE Interface ANKOI	£282.00c

PRINTERS & PLOTTERS

EPSON FX 80	£350.00
EPSON RX-80 FT	£250.00
EPSON FX 100	£450.00
EPSON DX 100	£460.00
Printer Sharer + Cable Set	£88.00
SEIKO SHA CP100A	£160.00
JUKI 6100 Daisy wheel	£350.00
MCP40 Col. Printer/Plotter	£120.00

Accessories:

Parallel Printer Lead	£10.00
Serial Printer Lead	£8.00
Epson Serial Interface 2K B148	£60.00
Epson Serial Interface B143	£50.00
NEC Serial Interface	£42.00
Epson Paper Roll Holder	£17.00
FX-80 Tractor Attachment	£37.00
PAPER Fanfold 2000 sheets	£13.90
Ribbon MX80/RX80/FX80	£6.50
Printer Sharer Parallel	£65.00
3 computers - 1 printer	£350.00
Gemlin Delta 10	£125.00

CDLOUR/GREEN MONITDRS (leads Incl)

Microvitec 1431 14" RGB Std Res	£196.00
Microvitec 1431PS 14" RGB/PAL + Sound	£225.00
Microvitec 1451 14" RGB Med Res	£299.00
Microvitec 1441 14" RGB Hi Res	£420.00
Microvitec 2031 20" RGB Std Res	£287.00
KAGA Vision I 12" RGB Med Res	£230.00
KAGA Vision II Hi Res	£260.00
KAGA Vision III 12" RGB Super Hi Res	£358.00
KAGA 12" Green Hi Res	£106.00
SANYO DM812CX 12" Green Hi Res	£99.00
KAGA RGB Lead	£6.00
BNC Green Screen Monitor Lead	£3.00

BBC COMPATIBLE 5.25" DISC DRIVES:

(All include cables, manual + format disc)	
100K (40 Track)	£140.00
100K (40 Track) with psu	£165.00
200K (40/80 Track)	£175.00
200K (80 Track) with psu	£210.00
400K (80 Track DS)	£195.00
400K (80 TOS) with psu	£225.00
2x 100K (40 Track) with psu	£320.00
2x 200K (40/80 Track) with psu	£400.00
2x 400K (80 Track DS) with psu	£420.00
3" Hitachi 100K Drive	£160.00
Accessories:	
40/80 Track Switching Module	£30.00

ALL PRICES EXCLUDE VAT. Please add carriage 5

GRAPHICS PLOTTER/WORKSTATION



Equally at home in the artists studio, hobbyists workshop, scientific laboratory, classroom, and production floor, this system has something to offer everyone. The 3-colour graphics plotter provides both precision and versatility. The carriage can be moved with an accuracy of 0.025 cm. over an A4 area — the plotter being able to accept paper and far thicker materials at sizes of up to A3. The basic colour plotter carries three colour pens each of which is software selectable. Various add-ons greatly increase the versatility of the unit, while retaining the unit's accuracy. The servo controlled drill/router, and scriber enables drilling, cutting and scribing in various materials. The unique Opto Sensor (using a Hewlett Packard Device) turns the plotter into a high resolution scanning digitiser to read and store whole diagrams, for example, for use in map work. This unique versatile Workstation is supplied complete at £490. All items are available individually, with the basic plotter at £270.

Everything you need for your BBC Computer

Plus friendly service and professional advice

Disc Cable	£6.00d	6502 M/Code for Beginners	£5.95
Disc Cable	£8.50d	6809 Assembly Lang Programming	£13.95
DS/Pkt of 10	WABASH 3M	Advanced Prog Tech for BBC	£7.95
SS/S0	£14.00	Advanced 6502	£10.25
DS/D0	—	Advanced User Guide	£12.95
SS/00	£24.00	Assembly Lang Pro on the BBC	£7.95
OS/00	£26.00	Assembly Lang for the BBC	£7.95
OS/00	£30.00c	Assembly Lang for Electron	£7.95
Time Warranty on 3M Discs	—	Assembly Lang Programming	£8.95
Double Sided Disc	Each £4.50c	Basic Prog on the BBC	£6.95
PPICLENE Drive Head Cleaning Kit	£14.50c	BBC Basic	£5.95
Library Case	£2.50d	BBC Basic for Beginners	£6.95
File Case 30/40	£8.00c	BBC Micro for Beginners	£6.95
Lockable Case 30/40	£16.00c	BBC Micro Compendium	£14.95
Lockable Case 60/70	£27.00c	BBC Micro Disk Companion	£6.95
ROMS:		BBC Micro Expert Guide	£6.95
Telephone for availability		BBC Micro Graphics & Sound	£6.95
SOFTWARE:		BBC Micro in Education	£6.50
ARM/MERLE BUSINESS SOFTWARE		BBC Micro Revealed	£5.00
Accounting, Stock Control, Accounts Payable,		BCPL User Manual	£15.00
Quotations Receivable, Order Processing,		Beyond Basic	£7.25
Accounting System	Each £22.65d	Creating Adventure Progs.	£6.95
MINI Leisure - Full Range		Creative Graphics	£7.50
RN/MSOFT - Full Range		DIY Robotics & Sensors	£6.95
PROGRAMMING LANGUAGES including BCPL, LISP		Discovering BBC M/Code	£6.95
with Manuals		Forth	£7.50
MSOFT - Full Range		Friendly Computer Book	£6.95
GRAM POWER - Full Range		Graphics on the BBC Micro	£6.95
RN/MSOFT (Electron) - Full Range		Graphs & Charts	£7.50
BUGSOFT - Full Range		Interfacing the 6502	£10.95
Twelve Spellingcheck Disc	£16.50d	Intro BBC Micro	£5.95
on	£16.50d	Let YA BBC Teach U 2 Prog	£5.00
erplot	£16.50d	LISP	£7.50
erfile (Database)	£16.50d	Making Music on the BBC Computer	£5.95
Text Pack (Mode 7 Graphics)	£16.50d	Micro Basic Sound Graphics	£7.95
CASSETTE RECORDERS:		MOS Memory Data Book	£3.95
YO OR 101 Data Recorder	£34.00b	Prog the BBC Micro	£6.50
x Slim Line	£24.00c	Programming the 6502	£9.95
Tape Recorder	£28.50b	Programming the 6809	£11.95
ette Lead	£3.00d	Programming the 8086/8088	£10.95
BIT Floppy Tape	£135.00b	Programming the BBC	£6.50
BIT Zero Memory Option	£25.00d	Programming the Z80	£9.95
puter Grade C-12 cassette	£0.50d	Start Prog with Electron	£6.95
puter Grade Cassette 10 off.	£4.50c	Structured Programming	£6.50
ips Mini-data cassette	£3.00d	The Computer Book	£5.95
BOOKS (NO VAT) p & p £1.50/book		The Electron Book	£7.95
Programs for the BBC	£6.95	TDRCH Z80 Disc Pack Guide	£10.00
our Basic	£5.95	TTL Data Book Vol-1	£9.00
educational Progs.	£6.95	TTL Data Book Vol-2	£5.20
2 Applications	£9.75	User Guide	£15.00
2 Assembly Lang Programming	£12.95	Using BBC Basic	£10.00
		Using Floppy Disks	£8.95
		Using the 6502 Assembly Lang	£14.50
		Z80 Applications Book	£10.95

MANY MORE BOOKS IN STOCK

ACORN IEEE INTERFACE

A full implementation of the IEEE-488 standard, providing computer control of compatible scientific & technical equipment, at a lower price than other systems. Typical applications are in experimental work in academic and industrial laboratories. The interface can support a network of up to 14 other compatible devices, and would typically link several items of test equipment allowing them to run with the optimum of efficiency. The IEEE Filing System ROM is supplied. **£282.**

DISC DRIVES:

A full range of disc drives fitted with quality Japanese slimline mechanisms, (such as TEAC, MITSUBISHI etc.) are supplied ready to connect to your BBC, and come complete with necessary cables, formatting disc, manual etc. TEAC & MITSUBISHI mechanisms can operate in single and double density modes. The switchable disc drives give the user flexibility, by allowing access to both 40 & 80 Track discs. The 40/80 Track switching module can be simply attached to your standard 80 track drives thereby vastly increasing their versatility. We have a full range of diskettes, variety of disc storage cases, disc-drive cables. The Floppicleene head cleaning kit, is the ideal way to ensure optimum performance of your drives. The use of disposable cleaning discs eliminate the risk of recontamination and abrasion, and ensure continuous data capture and transmission.



KENDA DMFS

A truly professional double density DMFS with several unique features:- *requires no RAM i.e. PAGE=&E00 *uses standard CP/M filenames & disc drive conventions *no limit to number of files *single/double density automatically selected *runs most 'protected' software *enables 80 Track drives to read 40 Track discs.

SCOTCH 3M FLOPPY DISCS

We now stock the high performance yet economical 3M range. Due to advanced production techniques, a higher standard has now been reached, enabling Scotch to guarantee error free performance for life.

3" HITACHI DISC DRIVES

The latest in miniature data-storage technology. Totally hardware & software compatible with 5¼" drives (can be used together!). Supplied complete with format disc, manual, cables etc. **£160(b).**

ULTRACALC

With advanced features, such as: *Handling of labels as well as numbers, as values, allowing the search of a list by a meaningful name, instead of just a number. *Efficient memory usage allowing large spreadsheets to be constructed. *Variable width columns. Facilities include SUM, Replicate & most mathematical functions. It helps you to create and manipulate *Budgets *Cash-Flow forecasts *Price Lists *Balance Sheets *Time Sheets *Order Entry *Small Databases *Scientific Calculations etc. **£65.**

Continued on page 6. →

INSTITUTIONS & EDUCATIONAL ESTABLISHMENTS

Our bulk purchasing power enables us to provide very competitive quotations, as well as being able to supply in quantity, a very wide range of equipment, accessories and spare parts from stock.

TECHNOMATIC LTD.

All prices exclude carriage & VAT. Please add carriage as indicated and add 15% VAT to the total order value. For fast delivery telephone your order quoting VISA or Access card or official order number. (Minimum telephone order £5).

Prices indicated as follows: (a) £7 (b) £2.50 (c) £1.50 (d) £1.00

MONITORS:

NEW LOW PRICES

ROVITEC—a range of British Made DTI/ACORN approved Std/Med/Hi-resolution RGB colour monitors have a consistent, reliable performance. Also available in RGB/SOUND versions. The KAGA range provides a similar performance in 12" screen format. Our Japanese manufactured Hi-Res green screen SANYO is a solution for high clarity 80 column text display. The KAGA green screen, its 'chemically etched' anti-glare screen for the discerning user. All monitors are supplied with suitable leads at no extra charge.

BUZZBOX

is a full specification, direct connect modem, with both Originate & Answer facilities, allowing access to the many databases, bulletin boards, as well as computer communication. The modem conforms to the international IT V21 300/300 Baud standard. (NOTE: Not suitable for PRESTEL). Having BT Approval, it connects directly to the telephone line, for optimum performance. Being battery powered, it is totally portable (optional power supply available). **£69.** BBC Lead **£3.50.** External PSU **£8.00**

CORN/MSOFT/MIRLE BUSINESS SOFTWARE

long awaited range brings professional business software to the small business user at a budget price. Available on disc only, using genuine 'random access', each package can, if required, be linked together to provide a totally integrated business system. Modules comprise Invoicing, Order Processing, Stock Control, Accounts Receivable, Accounts Payable, Purchasing, Mailing etc. Each package **£22.65(d).**

MAIL ORDERS TO: 17 Burnley Road, London NW10 1ED
(Tel: 01-452 1500, 01-450 6597 Telex 922800)

SHOPS AT: NW London: 15 Burnley Road, London NW10 1ED
(Dollis Hill 2 mins walk, ample car parking space)

West London: 305 Edgware Road, London W2, Tel: 01-723 0233
(Near Edgware Road)

EPROM PROGRAMMER:

A fully self-contained mains-powered eprom programmer housed in an attractive finished case. It is able to program 2716, 2732/32A, 2764 & 27128's in a single pass. It is supplied with vastly superior software when compared to any currently available similar programmer. In addition to normal eprom programming, you are now able to load your favourite basic programs onto eprom.



The programmer comes complete with cables, software & operating manual.
£89 + £2.50 carriage. Software on disc £2 extra.

- * Menu Driven Software provides user friendly options for programming the eprom with:
 - a) Basic programs.
 - b) Ram resident programs.
 - c) Any other program.
- * Programmer can read, blank-check, program & verify at any address/addresses on the Eprom.
- * Personality selection is simplified by a single rotary switch.
- * Programming voltage selector switch.
- * Full Editor with ASCII Disassembler, allowing direct modification of memory data in HEX or ASCII.
- * Continuous display of time left for completion of programming.
- * Continuous display of current addresses as they are being programmed.

EPROM ERASERS



UV1T Eraser with built-in timer and mains indicator. Built-in safety interlock to avoid accidental exposure to the harmful UV rays. It can handle up to 5 eproms at a time with an average erasing time of about 20 mins. £59 + £2 p&p.
UV1 as above but without the timer. £47 + £2 p&p.

SPECIAL OFFER
EPSON FX 80
PRINTER
ONLY £325

including BBC printer lead
Twelve Months full warranty.
Offer valid while stocks last.

'TIME-WARP' REAL-TIME-CLOCK/CALENDAR

A low cost unit that opens up the total range of Real-Time applications. With its full battery backup, possibilities include an Electronic Diary, continuous display of 'on-screen' time and date information automatic document dating, precise timing & control in scientific applications, recreational use in games etc—its uses are endless and are simply limited by one's imagination. Simply plugs into the user port—no specialist installation required—No ROMS. Supplied with extensive applications software.
Please phone for details.
£29.00 + £2.50 carriage.

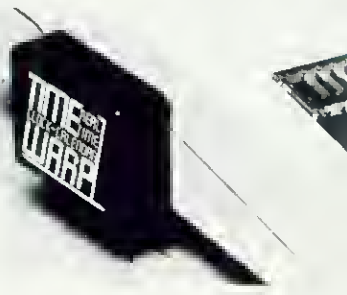

SMARTMOUTH:

The original 'infinite speech'.
Still the best.

A ready built totally self contained speech synthesiser unit, attractively packaged with built-in speaker, AUX output socket etc.—no installation problems! It allows the creation of any English word, with both ease and simplicity, while, at the same time being very economical in memory usage. You can easily add speech to most existing programs. Due to its remarkable infinite vocabulary, it uses spread throughout the whole spectrum of computer applications—these include industrial, commercial, educational, scientific, recreational etc. No specialist installation—no need to open your computer, simply plugs into the user port—and due to the simple software, no ROMS are needed. SMARTMOUTH is supplied with demo and development programs on cassette, and full software instructions. £37 + £2.50 carriage.



ELECTRON ADD ONS NOW IN STOCK

PRINT PORT

- * Suitable for most centronics printers
 - * Supplied complete with lead & programming.
- £39 + £1.50 p&p

JOY PORT

- * Controls over 80% of available arcade games.
 - * Uses ATARI Style 9 pin joysticks
 - * Just plugs in—no soldering
 - * Does not overload Electron psu
- £14.75 + £1.60 p&p

BEEBUGSOFT

A professional range of Firmware/Software to suit both the advanced programmer and the user. From the well known 'EXMON' and 'TOOLKIT' to the WORDWISE SPELLCHECK.

See our double page spread advertisement on pages 4 and 5.

MAIL ORDERS TO: 17 Burnley Road, London NW10 1ED
(Tel: 01-452 1500, 01-450 6597 Telex 922800)

SHOPS AT: NW London: 15 Burnley Road, London NW10 1ED
(Dollis Hill 2 mins walk, ample car parking space)

West London: 305 Edgware Road, London W2. Tel: 01-723 0233
(Near Edgware Road)

TECHNOMATIC LTD.

All prices exclude carriage & VAT. Please add carriage as indicated and add 15% VAT to the total order value. For fast delivery telephone your order quoting VISA or Access card or official order number.
(Minimum telephone order £5).

Healthy link for Acorn

BRITISH Telecom is preparing to launch a major networking system for the health industry – based around the Acorn Electron.

The Electron is at the heart of a terminal box, called Merlin M2105, that will be provided in the system known as Healthnet. This will link GPs, hospitals, district nurses and health centres to a central computer over the standard phone lines.

Circulars from drug companies, the Department of Health and hospitals could then be sent through the central computer to some or all of the Healthnet terminals.

BT refuses to give specific details of the system, because it will not be launched until the autumn. However, one of the terminals was due to be shown at Communications 84 in Birmingham.

The estimated cost for the terminal is about £1000, for which users will get an Electron (in BT livery), a specially-developed add-on box, printer, monitor and power supply.

The add-on box is impressive: 48k ROM, 64k RAM (32k with battery back-ups so its contents are not lost when the machine is

switched off), RS423 and Centronics interfaces, and the 'Kenneth Kendall' voice generator.

The voice chips are there to provide an answering service if any calls are received that are not from a computer.

One of the major tasks for the Merlin will be to relieve doctors and other health professionals of some of their paperwork. They will be able to design and store their own forms and documentation, or download standard versions from the central computer.

Networking to other terminals on a site, such as a hospital, will be possible through the standard telephone switchboard within the building. Users will be able to send messages by just typing in a phone number on the system. The battery memory will store a record of messages sent on Healthnet.

The hardware side of the project was developed at Acorn with some of the system software, while BT wrote the modem and other software. Field trials are underway within Telecom and at one of the London hospitals.

BT is unwilling to say whether the system will be marketed for other users, but one person close



Curry – and what the doctor ordered

to the project commented: 'Medicine is the first crack, they are interested in other areas'.

Acorn will not be able to market the add-on box itself because it was developed under contract for BT. However, the company is obviously proud of what the system can do. A spokesman at Acorn explained: 'You think of an idea and Chain can be used for it'. (Chain was the name given to the system during development.)

Acorn undoubtedly has other ideas for the Electron under way, but the only comment was one often heard nowadays in the security-conscious company: 'We can't talk about those yet'.

Acorn acquires Torch

ACORN has reached an initial agreement to take over Torch Computers. The deal was signed early this month by Chris Curry, Acorn's managing director, and Bob Gilkes of Torch.

Talks started last August and came out of discussions with Chris Curry over the suitability of Torch's Unix for the US market.

Acorn director Alex Reid said he hoped Torch would market Acorn's ABM but that 'there has been no attempt to rationalise our product ranges so far'.

Both companies stressed that their ranges were compatible and neither expected to shelve products. A Torch spokesman said, 'Torch will become a subsidiary of Acorn plc – effectively the business arm'.

The takeover is expected to be complete by June.

Acorn's Icon

ACORN has bought into Torus Systems, which is launching a graphics-controlled local network called Icon, the first version of which is for the IBM Personal Computer.

Acorn MD Chris Curry sees the link as complementing his company's expertise in networking, and it will no doubt fuel speculation on the direction Econet is likely to take in the future.

Hobbit upgrade

IKON has launched an improved version of its Hobbit floppy tape drive. Called the Ultra-Drive, it costs £80 and gives 200k per cassette and is claimed to be ten times as fast as normal cassettes.

By command ...

ACORN and Microvitec have both received Queen's awards for technical innovation.

Microvitec's accolade coincides with its entry onto the Unlisted Securities Market after 1983 profits of £2.5m on sales of £9.5m. The monitor manufacturer has also just presented the 20,000th monitor under the government's funding for schools schemes.

Telemod price

OEL has asked us to point out that its modem, Telemod 2, costs £84.95, and not £100 as stated last month.

Acorn User Olympia show twice as big

THE 1984 Acorn User Exhibition looks set to double the number of stands over last year.

The venue is Olympia 2, where the PCW Show will follow a month later. More than 30,000 people are expected to attend over the four days to walk around the 150 stands – two thirds of which have already been booked.

The big software houses such as Micropower, Superior and Computer Concepts are in, plus Acorn and Torch, as well as the smaller, more unusual companies such as the Miniature Tool Company, British Micro and Parfitt Electronics.

Olympia 2 is in Earls Court, West London, and the exhibition starts on August 16, running through to Sunday, August 19.

Details from Tim Collins, Computer Marketplace Exhibitions, 20 Orange St, London WC2H 7ED. Tel: 01-930 1612.

Beeb graduates to 16-bit

THE Graduate gives the BBC micro the ability to run software and hardware produced for the 16-bit IBM Personal Computer – and it costs under £700.

Data Technology, founded by Torch founder Martin Vlieland-Boddy, is the company behind the product, which will be launched at the Computerfair in June.

The Graduate provides 128k RAM, and is built around an 8088 processor that will run the MS-DOS operating system. Two versions, the G400 and the G800, will cost about £690 and £1000 respectively (the G800 has two 400k disc drives, the G400 one).

Bundled with the G800 is the latest Perfect software, which gives colour displays, and is estimated to be worth £1200.

The Graduate plugs straight into the 1MHz bus and no disc interface or sideways ROM is needed. A power supply is built in as well as two hardware expansion slots to take peripherals such as a mouse or 3270 emulation board.

'The discs are IBM format', says Vlieland-Boddy, 'so you can take an IBM disc and run it on our machine. It will run all the available software for the IBM PC and it's hardware compatible so it can use all the IBM peripherals being produced.'

The BBC-Graduate combination offers a saving of something like £1500 over the PC, and would have the advantage of the Beeb's display facilities.

Allan Wright, former Torch technical director, has joined Vlieland-Boddy at Data Technology, which was set up last December.

Vlieland-Boddy was very specific on delivery dates: 'We are taking orders and should deliver 250 machines by July. It uses the 8088 chip set, where there has been a drought, but we've got 5000 sets'.

This is backed up by an order placed with BASF for 5000 disc drives to go into the Graduates – an order worth about £2m, according to BASF.

BBC MICRO IN MANCHESTER

PRICES ...

All our prices are constantly moving, so please ring us to check the latest price.

FREE DELIVERY TODAY (Orders over £90)

If you are in Greater Manchester, Cheshire, Lancashire, Merseyside, West Yorkshire or South Yorkshire, if you ring us now we can send one of our highly trained staff to install your computer equipment Today.

WE WILL INSTALL IT

TEAC 55SRS2



£157.95 inc VAT

The latest 55 series from TEAC is now available from us. These disk drives are the new LSI low power consumption high performance version of the famous 55 series.

100K version
at **£157.95 inc VAT - 55A2**
400K version 40/50
at **£227.95 inc VAT - 55F2**

Chinon 100K **£134.95 inc VAT**

Z80 PROCESSOR

£375

Torch computers bring you the power of CP/M software on the BBC Micro. The Z80 runs at 4MHz and 64K RAM with 4K ROM. The Z80 card fits internally and requires a double-sided 80 track disk drive plus a BBC Micro with disk interface.

Also available is a full range of Business and Programming language software.

— includes **FREE Perfect Software Database, Word Processing + Spreadsheet.**

STAR 10X

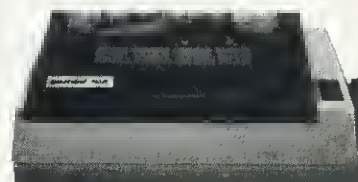

£199 + VAT

The Star 10X is a Centronics, 9x7 Dot Matrix head. It prints at 120 cps, is bidirectional and logic seeking. Buffer is 8K expandable to 8K. Prints 17 to 5 characters per inch. Prints 136 to 40 columns. Ten character sets including down-loadable and italics. Printer screen dumps up to 120x120 points.

Epson compatible. Colour screen dumps available.
Incredible value for money!

LEASING AVAILABLE

For example:

Disk Drive and Interface **£1.83** per week
BBC Model B **£3.18** per week
(over 3 years)

Please ring for more details.

C ★ TECH COMPUTERS

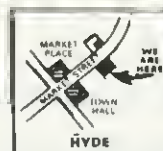

**184 Market Street,
Hyde, Cheshire
SK14 1EX
061-366 7794
061-366 8223**

BBC MICRO HARDWARE (inc VAT)

BBC Model B **£399**

BBC Model A **£299**

BBC Model A + 32K **£339**

Disk Interface **£89**

Disk Interface with double capacity option **£89**

Speech Synthesiser **£55**

MEMOREX DISKS

Double Sided - Double Density

£1.50 inc VAT

Box of Ten **£14.50 inc VAT**

MONITORS

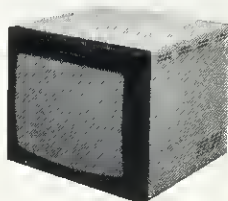

COLOUR
Microvitec **£219 + VAT**
Sanyo Normal **£209 + VAT**
Fidelity TV/Monitor **£199 + VAT**
GREEN
Sanyo Normal **£79 + VAT**
Sanyo Hi-Res **£109 + VAT**
Philips Hi-Res **£79 + VAT**

PERIPHERALS

MODEMS

OEL200 **£73 + VAT**

Prestel Terminal
£17.39 + VAT

Teletext
£195.65 + VAT

Joysticks
£14.95 inc VAT

PRINTERS

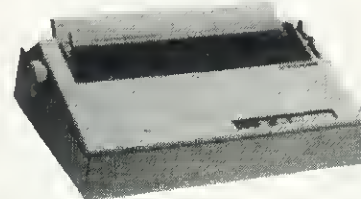

DAISYWHEELS
Silver Reed EXP500 **£299 + VAT**
Brother HR15 **£399 + VAT**
Brother Sheet Feeder **£199 + VAT**

DOT MATRIX
Star 10X **£199 + VAT**
Epson FX80 **£399 + VAT**

AS USUAL LOADS OF SOFTWARE AVAILABLE Tel: 061-366 8223

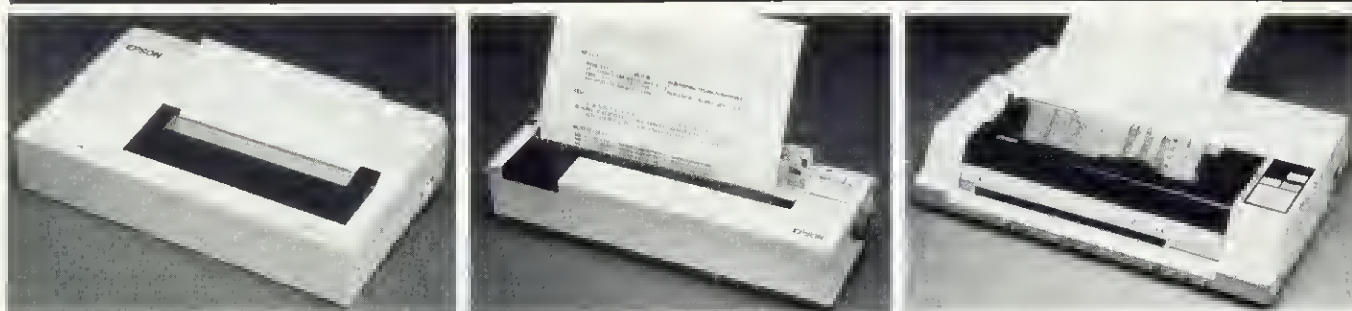

New Epson runners: the £95 P-40 portable (left), the thermal transfer model P-80, the and HI-80, the company's first colour plotter

Six-pack send-off for Electron ROM box

PLUS 1, Acorn's add-on box for the Electron exclusively revealed in last month's *Acorn User*, will be launched at the end of May at £59, including VAT. And Acornsoft will be releasing six examples from its range in ROM format to coincide with the launch.

Three of the half-dozen will be arcade games: *Hopper*, *Snapper* and *Starship Command*. Then there will be the adventure *Count-down to Doom*, the computer language Lisp and finally the home education program *Tree of Knowledge*.

The ROM cartridges will cost

about £20 each, which sounds expensive by cassette standards, but is about par for the course.

Others are planned, with another six 'coming soon'. The titles are still under wraps, but Acornsoft admits that a word processor and spreadsheet are on the way.

Meanwhile, Pace is driving hard to be first on the market with a complete disc filing system for the Electron. The system was demonstrated in London last month, but Pace has yet to announce a price and date for release.

The unit will be a totally enclosed 5 $\frac{1}{4}$ in disc drive and inter-

face which connects via a ribbon cable to the expansion bus at the rear of the micro.

The interface itself will use the 8271 disc controller chip, as used on the Beeb, plus a revised version of the Amcom disc filing system. Pace says this system will allow the Electron to load Beeb discs.

The Electron disc system will be available in both 40-track and 80-track formats and a special 'take-off' connector will allow other peripherals such as printer and joystick ports to be attached without interfering with the Pace system.

New quartet from Epson

TWO portable thermal printers are among four new printers to be launched by Epson this year.

These are the budget P-40, retailing at £95 + VAT and due out in August, and the P-80, Epson's first thermal transfer printer (£160 + VAT), available in October.

The P-40 is a compact dot-matrix model (46 x 216 x 128mm) which prints across 40 columns on friction-led thermal paper. It prints at 45cps and 80 or 20 characters per line are selectable with condensed or enlarged character modes. It is driven by rechargeable batteries.

The P-80 – with 80-column capacity – runs at 45cps and prints in both text and graphics mode. It offers 63 international characters, a 96 ASCII character set and prints in both Pica and Elite in regular, condensed and enlarged modes.

Paper is friction-fed and sheets of 5 $\frac{1}{2}$ x 8 $\frac{1}{2}$ in can be used. It can run with or without the thermal transfer ribbon. The P-80 also has rechargeable batteries.

In July Epson is launching a colour printer, the JX-80, which it believes to be the first to default to monochrome. Retailing at £560 + VAT, this is a 160cps dot-matrix printer that will produce up to seven colours. It has the same command set as the FX-80.

The fourth member of the quartet is Epson's first printer/plotter, the HI-80, which at £400 + VAT the company is promoting as the lowest-priced model in the UK.

Control lists free – from BBC

FANS of *Computers in Control*, broadcast in March and April, can now download (free) the software demonstrated in the BBC TV series – if their Beeb is fitted with a teletext adapter.

The software has been designed by the BBC Telesoftware Service to control external pieces of equipment through the micro's I/O connections, and enthusiasts will receive specifications for building their own equipment.

See page 700 of *Ceefax* for details.



NORTHERN Computers is hitching a buggy to its Micropulse Young Trainer, an educational robotics device launched in March that connects to the BBC and works under training software. The three-wheeled Micropulse buggy, costing £29 + VAT, comes with two light-dependant resistors that can be programmed so that it follows a torchlight beam or stops on contact with it.

Prestel rationalises micro databases

PRESTEL has made major changes to the way it handles Micronet 800 and the other micro databases. They will all now come under one umbrella called Prestel Microcomputing, and one standard subscription will be paid by users.

Under the new system, Micronet

is treated in the same way as all the other information providers. It loses its exclusive start-up frame and the sole right to charge subscriptions. At the same time, databases such as Viewfax 258 which were formerly free now come under a subscription charge of £8 a quarter.

The launch was originally set for April 2 but was delayed until May 11.

Prestel Microcomputing will also be expanding, adding several new databases this year. These include Head Start for home users and Executive Micronet for business, both in June, to be run by



Change of status ...

Micronet.

School Link, put together by Prestel and *Educational Computing* magazine, will start in September.

ITV launches Sunday show

A WEEKLY series of five half-hour television programmes called *Me and My Micro* starts on ITV on June 10.

The Sunday morning shows, presented by actor, mathematician and *Playschool* star Fred Harris, is claimed by its makers, Yorkshire Television, to be the first TV series to acknowledge that programs are more fun than computers, software is more interesting than hardware.

Fred Harris will use familiar games to illustrate the fundamentals of Basic. The series aims to provide the building blocks with which the beginner can develop programs.

A different micro-user will make a guest appearance in each show - including a Midlands vicar who uses a Spectrum to teach confirmation candidates and a Yorkshire grandmother who generates knitting patterns on her micro.

A booklet based on the show is being published at £2.95, written by Paul Shreeve and published by the National Extension College.

Changes in View

ACORNSOFT has denied rumours that its View word processor chip has been withdrawn and refused to say officially whether an improved version is set for release.

Dealers have reported a dearth of the chips, while View 2.1 has been seen in ROM with several improvements over the first release (issue 1.4).

The fact that 2.1 is in ROM suggests it is about to be released, because software is expensive to produce in this way unless ordered in large numbers. Normally trial issues are put into EPROMs that are short-run chips and re-usable.

Acornsoft is quick to quash the rumours. A spokesman said: 'View has proved very popular and we intend to carry on selling it. Any rumours that we have withdrawn it are groundless.'

'There has been a shortage because of demand, for which we

apologise to customers, but we will solve this very quickly.'

On View 2.1 the company is very tight-lipped: 'We have a policy of continual development and may produce a new version in the future.'

The issue of View sold as standard on the American BBC micros is different from the British one, and this may have been used as a model for 2.1. Among the added facilities in the new chip is the ability to print directly from the screen without having to save a file first.

One possible reason for the short supply of View is the worldwide famine of chips, which also appears to be holding up the release of Viewsheet, Acornsoft's spreadsheet.

This is the next step in the development of a View 'family' of software, which will all link into the word processor.

Viewsheet provides several so-

phisticated facilities, among them the ability to put as many as 10 different windows from the same spreadsheet on screen at the same time.

Subsidiary disc files can be created so that the information they contain will be automatically updated when changes are made to the sheet that is being worked on.

Sheets can be spooled to disc and then read in to View for editing or for, say, inclusion in a company report. Also, sheets can be used in any screen mode, so mode 7 will give the ability to hold a very large sheet in memory.

Acornsoft will not give a release date for Viewsheet, apart from saying that it will be sold 'as soon as possible'. The next issue in the View family will be a much-needed printer-driver generator. What comes after that? 'I don't really want to talk about that,' said the Acornsoft spokesman.

Don't be fooled, these really are BASIC commands, and they can of course use any BASIC variable or expression, be situated in multi-statement lines, be used in line-entry mode, and in fact anywhere or anytime that the standard BBC BASIC commands can be used. No other sideways-ROM offers such facilities, they use 'star commands' that cannot match the ease of use of ADDCOMM's commands.



Graphics: SCALE, SMOVE, SDRAW, SPLOT, CIRCLE, ELLIPSE, CFILL, FILL, RDTATE, TRANS, UNSCALE, Toolkit: CHAR, FIND, COMPACT, MEM, FKEYS, VERIFY, GOODPROG, KILLREM, GREPL, SREPL, LVAR. Logo: ANGLE, LMOVE, PEN, TURN, ADVANCE, LCIRCLE, LELLIPSE, LPDS. Utilities: POPFOR, POPGOS, POPREP, LGOTO, OPT, LLIST, SORT, ADDCOMM, WIN, SETWIN, and an extensive *HELP facility.

Compatible with: Acorn DFS, Amcom DFS, Watford DFS, Disc Doctor, BASIC 1 and 2, Model B with DS 1.20.

ADD 40

WITH

ADDCOMM

COMMANDS TO BBC BASIC

ADDCOMM is as unique as it sounds, and at £28.00 including V.A.T., post and packing and a detailed manual, represents extremely good value for money.

Send cheque/postal order, (or a stamp for detailed brochure) to:-
VINE MICROS, MARSHBOROUGH, SANDWICH, KENT.
CT13 0PG

AN EXCITING B.B.C. MICRO PROGRAM FROM BRITAIN'S LEADING SOFTWARE HOUSE!

JACK THE POWER



Imprisoned by the evil warlord Nogrob the Terrible, Jack the intergalactic hitchhiker must collect fuel pods from the other side of the garage to refill the waiting starships. With a fast diminishing oxygen supply, an erratic Turbopak, and a band of nasty Space Googjies to contend with, Jack certainly has problems!

Only **£7.95** (inc.VAT)

PROGRAM POWER MICRO POWER PROGRAM POWER MICRO POWER PROGRAM POWER MICRO POWER

PROGRAM POWER MICRO POWER PROGRAM POWER MICRO POWER PROGRAM POWER MICRO POWER

AVAILABLE FROM ALL GOOD RETAILERS INCLUDING SELECTED BRANCHES OF BOOTS, JOHN MENZIES AND WH SMITH.

WRITTEN ANY PROGRAMS? WE PAY 20% ROYALTIES!

The following top titles are available for both the BBC Micro and Electron: Killer Gorilla £7.95/ Bendits at 3 o'Clock £6.95/Moonraider £7.95/Croaker £7.95/ Felix in the Factory £7.95/Felix and the Fruit Monsters £7.95/ Cheas £7.95/Draw £9.95/Escapes from Moorbase Alpha £7.95/ Cybertron Mission £7.95/Swoop £7.95/Intergalactic Trader £8.95/ Positron £8.95/Adventure £7.95

SHOWROOM: NORTHWOOD HOUSE, NORTH STREET, LEEDS LS7 2AA Tel: (0532) 458800
 MAIL ORDER: MICRO POWER LTD. 8/8a REGENT STREET, LEEDS LS7 4PE. Tel: (0532) 683186/696343

VISA

P & P: 55p per order

SPECIAL OFFER: Deduct £1 per cassette when ordering two or more

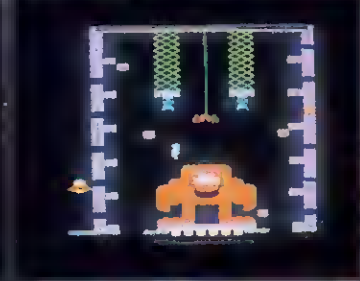
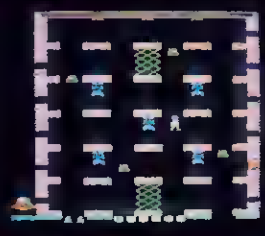

Sponsored by
The Micro User
and Electron User



There's much more to show. So this summer we go to a new home - to give us much more room to show it all!



Alexandra Palace, London, Thursday to Sunday, July 19 to 22

You must see for yourself all the rapid developments in the ever-expanding world of the Electron and BBC Micro!

School and College Groups

Entry only £1 per student if bookings are made in advance. Send your cheque (made payable to Database Publications) and SAE to:

Electron & BBC Micro User Show
68 Chester Road, Hazel Grove
Stockport SK7 5NY Tel: 061-456 8383

Valid for a minimum of 10 people

- ★ **SEE the latest software - hundreds of new games, educational and business programs.**
- ★ **SEE all the latest add-ons - never before have so many exciting new peripherals been launched.**
- ★ **SEE all the latest techniques - and get free advice from our team of experts, writers and programmers.**
- ★ **Make a note in your diary - NOW!**

VOUCHER WORTH £1

This voucher is worth £1 per person off the normal admission price of £3 (adults) and £2 (children) (Valid for a maximum of 4 people)

Electron & BBC Micro User Show

10am - 6pm, Thursday, 19 July
 10am - 6pm, Friday, 20 July
 10am - 6pm, Saturday, 21 July
 10am - 4pm, Sunday, 22 July

Alexandra Palace
 Wood Green, London N22

ALU

SOFTWARE CHART

	TITLE	PUBLISHER	TAPE	MICRO
1	(3) Snooker	Visions	£8.95	B/E
2	(1) 747 Flight Simulator	Dr Soft	£8.95 (£11.95)	B
3	(6) White Knight II	BBC Soft	£10.00	B
4	(8) Snapper	Acornsoft	£9.95	B/E
5	(4) Hobbit	Melbourne House	£14.95	B
6	(9) Transistor's Revenge	Softspot	£7.95	B
7	(-) Rocket Raid	Acornsoft	£9.95	B
8	(11) Killer Gorilla	Program Power	£7.95	B/E
9	(-) Gorf	Dr Soft	£8.95	B
10	(12) Zalaga	Aardvark	£6.90	B
11	(2) Twin Kingdom Valley	Bug-Byte	£9.50	B
12	(-) The Mine	Program Power	£7.95	B
13	(-) Fortress	Amcom	£8.95	B
14	(re) Chuckie Egg	A&F Software	£7.90	B/E
15	(7) Space Shuttle	Microdeal	£8 (£10)	B/E
16	(14) Hunchback	Superior	£7.95 (£11.95)	B/E
17	(-) Dare Devil Dennis	Visions	£8.95	B
18	(10) 737 Flight Simulator	Salamander	£9.95	B/E
19	(-) Hopper	Acornsoft	£9.95	B/E
20	(-) Mined Out	Quicksilva	£6.95	B

re = re-entry B = BBC E = Electron Prices in brackets are for disc version

BUBBLING UNDER

Amaze in Space	Opus	Sphinx Adventure	Acornsoft
Penguin	H Soft	Disc Doctor	Computer Concepts
Pedro	Imagine		

Compiled by RAM/Computer

HAVE the zappers been zapped? we asked, when only one arcade game figured in the top five last month. Not quite. They're fighting back, with *Rocket Raid* and *Gorf* leaping from nowhere to numbers 7 and 9 and other old arcade favourites - *Snapper*, *Killer Gorilla* and *Transistor's Revenge* - improving their positions.

Still, the more sedate stuff continues to dominate the medal positions. *Snooker* no doubt benefits from TV's constant championship coverage and *White Knight II*

has proved that it's the best chess software available - Acornsoft's *Chess* has dropped out of the list.

Expect *Aviator* to arrive next month if the tenacity of the flight simulators (including *Space Shuttle*) is anything to go by.

We tantared the arrival of the utility packs last month - and Pslon's *Vu-File* and the £40 *Wordwise* chip were promptly ousted. We console ourselves with the £33.35 worth of ROM in the *Disc Doctor's* waiting room!

SOFT ●● OPTIONS

SOFTWARE for the Electron has taken off with the release of **Salamander's** *737 Flight Simulator*. Written by a professional pilot, it includes a simulated engine failure! And **Micro Power** has now made most of its Beeb arcade titles available for the Elk, including old Beeb favourites such as *Killer Gorilla*, *Croaker* and *Escape from Moonbase Alpha*. The latest releases are *Danger UXB* and *Galactic Commander* and there's more on the way.

Constellation should make Electron users stargazing. It's just one of 11 titles released by **Superior Software** for this machine and the armchair astronomer can view a total of 455 stars from any point on the globe. Earthbound explorers can keep track of David Attenborough's latest expedition with *World Geography*, an educational program that covers 166 countries and makes use of the Electron's hi-resolution screen to test your knowledge of capitals and populations. Students of gambling can turn to *Fruit Machine*, whose features include spinning reels and HOLD, NUDGE and GAMBLE. Arcade action is provided by *Centibug*, *Alien Drop-out*, *Invaders* and *Percy Penguin*.

Something to write home about is the **Kansas Word Processor** for the Electron. Numerous facilities are offered, many of which can be implemented with a single key-stroke. Text is formatted using embedded control codes and each text file can be up to 4,200 words long. If you can't type, try the *Kansas Microtype* typing tutor.

Educational software for the Electron is available from **Ampalsoft**. *Maths Level 1* and *Easy Reading* are aimed at the over-fours, while *Maths O Level Revision Parts 1 and 2* help cramming students along the way with calculus, algebra and trigonometry. All titles are twin packs offering two cassettes containing four programs. Ampalsoft can be contacted on (0252) 876677.

Throw yourself in at the deep end with *Pool* from **Dynabyte Software**, or jockey for position with *Horse Race*, a family game for up to six players. Other intriguing programs include *Corporate Climber* (can you make it to the executive washroom in time) and *Lemming Syndrome*.

Who said there was no software around for the Electron?

All games
for BBC Micro
32K OS 1.2 only

MRM SOFTWARE

NEW
RELEASES

CASTLE ASSAULT

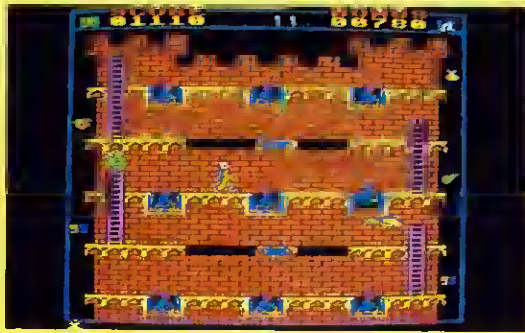

A glittering reward awaits the intrepid atop the heavily defended towering turrets of this forbidding fortress. On your quest for gold you will be assailed by a menacing menagerie of meanies, namely crabs, snakes, lobsters, spiders, bugs and beetles. Watch out for those malicious malades (the deadly Flying Ducks) as you dodge falling rocks, scale ladders and negotiate moving platforms. Collect various different fruits for bonus points on your way. Bonus man for every two bags of gold collected. Hi-score table, increasing difficulty and fantastic animation constitute this stunning game from MRM.

SCREWBALL



You are Screwball and you have 60 seconds to change the colour of all the squares that surround you (by simply jumping on them).

Menacing you all the time, however, are the 'BLACK BUGS' . . . and they sure are mean. They even cheat by sometimes not even walking on the squares.

If they catch you then I am afraid you lose a life. Kill the BUGS by digging holes for them to fall through. If you really are in a fix then as a last resort you may HYPERSPACE to the top of the grid . . . but you won't always survive the journey.

DARTS



Step up to the ocky and enjoy all the fun of competition darts with this high resolution version by MRM. A choice of 3 popular dart games, 501, Round the Board and Cricket is available in this package.

HANGMAN/SOLITAIRE



This great value two game package consists of a multi menu hi-resolution graphics version of Hangman (including a special category for children) with a colourful 3D version of Solitaire.

MRM SOFTWARE

17 Cross Coates Road
GRIMSBY
South Humberside
Telephone: 0472 44304

ALSO AVAILABLE

Q Man
Q Man's Brother
3D Munchy
Diamond Mine
Guy in the Hat
Banana Man
Secret Sam I
Secret Sam II

EACH GAME ONLY £5.70
FULLY INCLUSIVE

Most tapes available
from leading branches
of Boots

ACORN
ABUSER'S

Diary

■ OUR high-level programming friend Beebalus claims to have invented a brilliant two-player game based on *JCB Digger* (known as 'Judder') and *Aviator*. His idea is to run *Aviator* in the second 6502 processor and JCB in the I/O (first) processor. One player controls the JCB from the keyboard while the other flies the Spilfire with joysticks. The JCB has to dig up the runway, demolish Acornville and shake down the bridge before the aviator can take off, buzz Silicon Valley and come back to shoot up the JCB.

Beebalus expects to market the game through his company Deadwood Tax Avoidance (Jersey) Ltd.

A spokesman for Deadwood said: 'The game will be available before the end of the year in which it is released.'

■ FOLLOWING the picture in a brochure of the OL manual written in Latin, the news from the SinOLair camp is that Psion is producing a Latin-English translator to help you understand it.

■ BANANA control is the latest task for the Beeb. Broadway Electronics has won an order to supply the Windward Islands in the Caribbean with computers for stock control.

We hope there's no ship-up in delivery.

■ ACORN'S new model C android has hit back at rumours that Acorn has dropped plans to introduce a new range of 'Tom Huff'n'puff' marketing managers. The android claimed that a set of managers had arrived from National Semiconductor in lieu of chip-sets and should start marketing 'later in the year.'



Country cousin Curry

Chris Curry
cultivates his
Acorn acres

THE secret is out, hard-hitting Acorn MD Chris Curry, the man who set Sir Clive on the road to fame and fortune and then co-founded Acorn, has decided to return to the land.

Yes, the man whose contribution to British industry was so recently rewarded by the Queen and with a visit to No 10, has bought himself a farm.

We are sworn to secrecy as to its whereabouts, but the young millionaire will indulge his love of tractors and animals on its secluded acres.

We can, however, reveal exclusively that our Chris until recently kept a pet pig called Tig. But Tig became too big, so Chris had to give her up to a good home.

■ DEBBIE Harry walked into Microage and said: 'All I want is a ROM with a VIEW'. Not being very technically minded the salesman sold her a set of Microsoft Windows

Picture that!

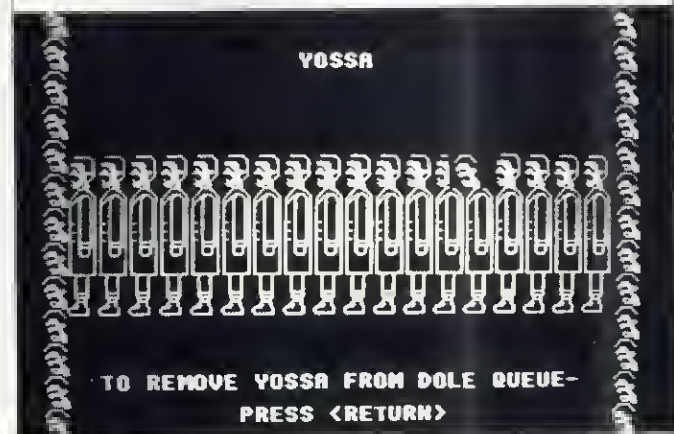
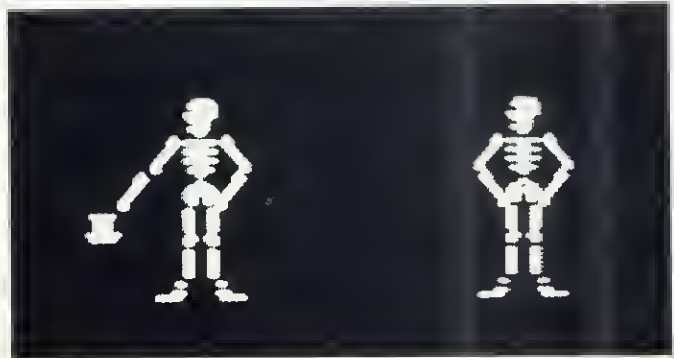

WHEN does black and white turn blue? When the BBC's mode 0 is used to produce naughty pictures. Modesty forbids us to disclose the source of these, er, animated scenes, but they're from a disc labelled 'Sicsoft' that found its way through our back door. The two pieces of software illustrated are excellent examples of cartoon animation featuring 'Gis a job I can do that' Yossa and a pair of performing skeletons. The rest of the disc would make Mary Whitehouse throw a wobbler.

■ NEWS from *The Other User* is that Barry Wood applied for a job to Acorn's PR department in Altrincham. He was turned down. In retribution he is now extending his Barry Wood's Hairpiece column to a full page and printing the views of would-be Electron owners.

■ DESPITE contrary reports, the Gluon could soon be un-forgotten. Incredibly, it can be glued-on not only to an Electron or an Atom but also to a SinOLair Plectrum, Commodore 64, Flan Enterprise (also known as Elan, Samurai, Fried Egg...); in fact it will turn any home computer into a Beeb. Sources claim that any program written for the Beeb will work perfectly on the Gluon!

Acorn will take orders for the Gluon 'very soon'. The price is expected to be just under £400 and you should quote the stock code ANB01 with your order.

■ Finally, dear readers, a little puzzle. What does the following Basic II and Electron program do?

```
10 DIM BLOCK 9
20 ?BLOCK = 31
30 BLOCK? 9 = 13
40 A% = 10
50 X% = BLOCK
60 Y% = BLOCK DIV 256
70 CALL &FFF1
80 PRINT$(BLOCK + 3)
```

Answers on a post-card to Mr A Wilson, Acorn Computers, Fulbourn Road, Cambridge. Over and out!

Jargon Jungle

ONE of our senior computer monthlies has come in for a pasting from one of our readers. L Whalley describes the offending paragraph thus: 'Pretentious, self-consciously clever rubbish'. For those who missed it first time round, hack your way through this piece of Jargon Jungle from the February issue of *Personal Computer World*:

'*The Joy of Computers* is recognisably one of a new generation of computer related publications. Pac-Man and partworks have

stalled, but the facts of real life - cars that are hand-built by robots and then talk back at the driver, trendy vicars getting flower rotas through the 6502 and the collected works of John Wesley onto Dysan - remain real enigma variations.'

Linnat Evans, who wrote the book review, may collect a small reward from our offices (readers may like to suggest a suitable one). L Whalley, our first Jargon Jungle winner, gets a crisp Wellington.

LOW PRICES MAINTAINED

COLOUR MONITORS

Microvitec 1431	£197.00
Microvitec 1451	£297.00
Fidelity CM14	£209.00

Monochrome Monitors

Sanyo DM2112	£75.00
Sanyo DM8112CX	£99.00
Teco Zcom	£105.00

Combined TV/Monitors

ITT RL2301	£280.00
------------	---------

Acorn Products

BBC Model 8	£399.00
88C Model 8 with fitted disc interface	£469.00
Electron	£199.00
DFS Kit	£97.00

Torch Products

ZEP 100	£322.00
Z80 DP2	£769.00

BBC Disk Interfaces

Kenda Mighty Oak	£90.00
Kenda Professional (Double Density)	£130.00

ALL PRICES SHOWN INCLUDE V.A.T.

These prices are for cash and carry sales

Dot Matrix Printers

Star Gemini 10X	£224.00
Star Delta 10	£365.00
KDC FT-5001	£259.00
Epson RX80	£249.00
Epson RX80 F/T	£279.00
Epson FX80	£379.00

Serial Interface Conversions

8143 - Epson	£30.00
8148 - Epson (2K buffer, XON/XOFF protocol)	£65.00
Juki	£55.00

Daisywheel Printers

Juki 6100	£375.00
Silver Reed	£315.00
Daisy Step 2000	£289.00

Daisywheel add-ons

Juki Sheet feeder	£239.00
Juki Tractor feed	£109.00

Product range constantly expanding, phone for latest details

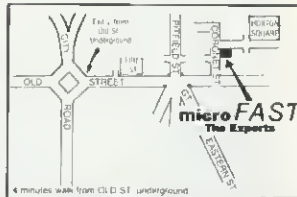

Single Disc Drives

100K(200K) Single-Sided	
40 Track	£150.00
200K(400K) Double-Sided	
40 Track 3-inch	£190.00
400K(800K) Double-Sided	
80 Track	£219.00
80/40 Track	£248.00

Double Disc Drives

400K(800K) Double-Sided	
40 Track 3-inch	£374.00
800K(1.6M) Double-Sided	
80 Track	£409.00
80/40 Track	£489.00

Floppy Disks

S/S D/D 40T	£1.80
D/S D/D 40T	£2.10
D/S D/D 80T	£2.90
3"	£4.50
Library Case	£2.00
(free library case with every 10 disks sold)	

microFAST

57 HOXTON SQUARE,
LONDON N1

OPEN FOR PERSONAL CALLERS
FROM MONDAY TO
SATURDAY,
9AM TO 6PM.

MAIL ORDER OR OTHER ENQUIRIES
01-729 1778
SAE for comprehensive Price List

Computer Concepts ROMs

Disc Doctor	£32.00
Termi	£32.00
Graphics Rom	£32.00
Print Master	£32.00
Wordwise	£42.00

Acorn Roms

View	£52.00
------	--------

BBC Roms

Ultracalc	£65.00
-----------	--------

Full range of Software from A&F, Program Power, Computer Concepts, Level 9, Acornsoft always available at discount prices

Supplies etc

Printer Cables	£12.00
- Extra quality	£15.00
Monitor Cables	£5.00
- CM14	£8.00
Ribbons	£
- Epson	£4.50
- KDC 2-shot	£7.00
- Daisystep	£4.00
- Juki	£2.00
Paper - 2000 sheets	£12.00

Mail Order

Software/Firmware	FREE
Hardware	£10.00

NEW

*** SEIKOSHA PRINTERS**
A new range of printers (Spectrum Compatible) replacing existing models

Prices from **£120-£300**
Dealer enquiries welcome.

ELECTRON PRINTER INTERFACE
£33.50 + VAT

ORGANISATION AT YOUR FINGER TIPS!

Hardware and Software for the BBC Micro. Just a few of our Business, Domestic & Educational Programs available on cassette or disc.

107 MEMO-CALC £12.95 + VAT B C/D

"It must be among the least expensive pieces of useful software you will ever buy" Review by Practical Computing July 1983

This is a database/calcsheet program which allows up to 255 columns. The number of rows is automatically set from 5 to over 1000 depending on the columns declared. Both numeric and alphanumeric data can be stored in any cell and can be of any length up to 255 characters.

106 PAYROLL (W or M) £24.95 each + VAT B C/D

Two part programs to handle the wages on a weekly or separately on a monthly basis for up to 100 employees in memory at the same time. Order as WEEKLY or MONTHLY. Oaduct £5.00 if both weekly & monthly programs purchased at same time. A PAYROLL update service is offered at £6.00 per annum + VAT

304 STATPACK £9.95 + VAT B C/D

A statistic peckaga written by Micro-Aid that first appeared in the Personal Computer World magazine between autumn of 1978 and the Spring of 1979 as a series of articles. This fascinating suite of modules will appeal to Schools, Colleges and businesses alike proving extremely valuable

102 CASHBOOK £11.95 + VAT B C/D

FIRST CHOICE. This is a double entry cashbook program showing cash and bank credits and debits, i.e. 4 columns. Any number of individual accounts can be used end analysed or totalled individually or cumulatively by associated group.

LANGUAGE & UTILITY ROM'S from many sources from £18
SEND NOW FOR OUR FREE BROCHURE!

Most of our programs are on PRESTEL (Micronet) * 60043703 and can be down loaded directly.

Micro-Aid

25 Fore Street, Praze, Camborne,
Cornwall TR14 0JX UK Tel: (0209) 831274

Computerama

the source

ROM SOFTWARE INC. VAT	
Wardwise	39.95
View	59.00
Printmaster	32.95
Disc Doctor	32.95
Termi (Terminal emulator)	32.95
Graphics Extension	32.95
Acorn Speech System Upgrade	55.00
HCCS Forth	39.95
HCCS Logo Forth	67.85
HCCS Pascal	57.00
HCCS Excal	74.75
ROM Expansion Board (ATPL) The Best!	43.70

BOOKS INC. VAT	
BBC Micro Disc Companion	7.95
Creative Graphics	7.50
Graphs & Charts	7.50
List Manual	7.50
Forth Manual	7.50
BCPL Manual	15.00
Discovering BBC Micro Machine Code	6.95
BBC Micro Disk Manual	1.95
Using Floppy Disks with the BBC Micro	9.95

PROGRAM POWER INC. VAT	
Killer Galleis	7.95
Cyberton on Mission	7.95
Chess B	7.95
Danger UXB	7.95
Escape Moonbase Alpha	7.95
Felix in Factory	7.95
Felix & Fruit Monsters	7.95
Nemesis	7.95
Bumble Bee	7.95
Wizards Challenge	7.95
Jet Power Jack	7.95
Position	7.95
Demon Decorator	6.85
Alien Swirl	7.95
Alien Destroyers	7.95
Ghoulis	7.95
Moon Raider	7.95
The Mine	7.95
Hell Drive	7.95
Labyrinthis of LaCasha	7.95
Zam	7.95

SUPERIDR SOFTWARE INC. VAT	
Road Runner	7.95
Hunchback	7.95
Overdrive	7.95
Ballettanz	7.95
Cosmic Kidnap	7.95
Sia Battle	7.95
Moon Mission	7.95
Percy Penguin	7.95
Boys in The Underworld	7.95
Rocky	7.95

DPUS INC. VAT	
Dogfight	8.95
BUG-BYTE INC. VAT	
Twin Kingdom Valley	7.95
DYNABYTE INC. VAT	
Hoisersce	7.95
Lemming Syndrome	7.95
Corporate Clamber	7.95

BBC/ACORN/SOFT INC. VAT	
Algebraic Manipulation	9.95
Aicadians	9.95
Business Games	9.95
Castle of Riddles	9.95
Creative Graphics	9.95
Countdown to Doom	16.85
Forth	9.95
Graphs & Charts	9.95
Hoppel	9.95
List	16.85
BCPL (Rom + Disc)	99.95
Missile Base	9.95
Meteors	9.95
Monsters	9.95
Peeko Computer	9.95
Planetoid	9.95
Rocket Raid	9.95
Snooker	9.95
Sphinx Adventure	9.95
Starship Command	9.95
Tire of Knowledge	9.95
Snapper	9.95
Shirley Conran's Magic Garden	9.95
Personal Money Management	9.95
Draughts and Reversi	9.95
Wordhunt	11.90
White Knight II	11.50
Vultype	16.10
Tax Calc	17.25
Beyond Basic	11.50
Toolbox	21.00
Canyon	10.00
Record Keeper	15.00
Doctor Who	10.00
ACORN/SOFT MIRLE NOW IN STOCK	P.O.A.

SOFTWARE INVASION INC. VAT	
Eagles Wing	7.95
Spooks and Spiders	7.95
3-D Bomb Alley	7.95
Gunsmoke	7.95
Vortex	7.95
All Jack on Alpha Centauri	7.95

VISIONS INC. VAT	
Snooker	7.95
Digger	7.95
Daredevil Dennis	7.95
PSION INC. VAT	
Saloon Sally	6.95
VuCalc	14.95
VuFile	14.95

MELBURNE HOUSE INC. VAT	
The Hobbit	14.95
MICROBYTE INC. VAT	
3D Space Ranger	7.95

SDFTWARE FOR ALL INC. VAT	
Stock Control (C/D)	19.95 29.95
Invoicing/Statements (C,D)	19.95 29.95
Sales/Purchase (C,D)	19.95 29.95

COMPUTERAMA SOLID STATE JOYSTICK INTERFACE

*** with RAPID-FIRE feature**

Now a totally new concept in joystick control for your BBC Micro. Simply plug into the analogue port, and connect ANY Atari type joystick for instant joystick control of conversion programme allows joystick control of keyboard-only games. No memory conflicts with this one - due to our unique Relocatable Code feature. **ORDER TODAY. Only a few available. Demand if bound to be high. ONLY.**

£14.98 + 50p Carriage

TORCH Z80 DISC PACK WITH OVER £1,100 OF SOFTWARE FREE

ORDER TODAY - Get the Z80 version of BBC Basic FREE (Was £125) plus BBC Micro programmes up to twice as fast, gives 32K for graphics AND 48K for Basic programme.

NOW ONLY £799 INC. VAT Free carriage UK only

Software includes:

- PERFECT WRITER
- PERFECT SPELLER
- PERFECT CALC
- PERFECT FILTER
- TORCH NET

The TORCH Z80 DISC PACK is the most powerful BBC Micro disc upgrade available, it provides 800K of storage plus a Z80 Second Processor running Torch's own CP/M compatible operating system. Clip this ad to your order to receive free 40:80T conversion programme.

NEW TORCH ZEP10 PACK Add Torch Power to any 80i disk drives. Complete 2nd Processor AND Free Perfect software worth £1000 ONLY

£429 inc VAT

QUICKSHOT II BBC MICRO JOYSTICK

Now with rapid fire Option and Solid State Interfaces. Optional Relocatable code feature - means that it WORKS with more games than any of her similar interface. This SELF-CENTERING JOYSTICK, works even with keyboard-only programmes. A sensation at the Micro User Show. More fun - teaches the games of hot joysticks cannot. Limited supplies of this item.

£19.95 + £1.55 p+p

ATPL SIDEWISE ROM EXPANSION BOARD

Full sideways Rom Expansion to 16 Roms

- 16K Battery backed CMOS Ram option
- No soldering required to fit sideways
- Full buffering of address and data buses - prevents data bus loading problems associated with unbuffered boards

ONLY £43.70 + £1.00 carriage

MAIL ORDER No Stamp Required

Post your order today to **COMPUTERAMA DEPT. AUS FREEPOST STAFFORD ST16 2BR** OR TELEPHONE OUR MAIL ORDER HOT LINE With your ACCESS or VISA number, we will endeavour to despatch immediately - **(0788) 41899.**

EPSON FX80 A SUPERB PRINTER AT A SUPERB PRICE

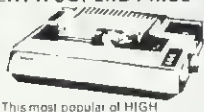

This most popular of HIGH PERFORMANCE dot matrix printers, has all the features you could ask for:

- 160 cps 11 x 9 matrix proportional spacing
- Normal, Elite & Italic Characters
- Tiered & Friction Feed 10 Carriage
- Bi-directional, Logic Seeking
- Canonics Interlace Standard
- Down loadable Character Set User Defined
- Condensed & Double Width Printing
- Super & Subscripts
- Dot Addressable Graphics

NOW AT THE AMAZING PRICE OF £389 inc VAT

WE ACCEPT INSTITUTIONAL EDUCATIONAL ORDERS

Full sideways Rom Expansion to 16 Roms

- 16K Battery backed CMOS Ram option
- No soldering required to fit sideways
- Full buffering of address and data buses - prevents data bus loading problems associated with unbuffered boards

ONLY £43.70 + £1.00 carriage

ATPL SIDEWISE ROM EXPANSION BOARD

Full sideways Rom Expansion to 16 Roms

- 16K Battery backed CMOS Ram option
- No soldering required to fit sideways
- Full buffering of address and data buses - prevents data bus loading problems associated with unbuffered boards

ONLY £43.70 + £1.00 carriage

HARDWARE CORNER

BBC INC. VAT	
ACORN ELECTRON	199.00
BBC Micro Model B	399.00
BBC Micro Model B + Double density DOS	489.00
BBC Micro Disc Upgrade	P.O.A.
BBC Micro A-B Full Upgrade	95.00
BBC Micro Teletext Receiver	225.00
BBC Micro Z80 2nd Processor	T.B.A.
BBC Micro 6502 2nd Processor	T.B.A.
Double Density DOS Upgrade	89.95
Page DFS	39.95
DISC DRIVES INC. VAT	
LVL Dual 100K	340.00
Page Single 100K	169.95
Page Single 40/80T D/Sided	282.90
Page Dual 100K	338.00
Page Dual 40/80T D/Sided	573.95
Torch Dual 400K Z80 Disc Pack	799.00
Page 200K 40T D/Sided	243.00
HOBBIT FLOPPY DRIVES INC. VAT	
Microvitec 14" Colour	229.00
Sanyo 14" Colour	269.00
Fidelity 14" Colour Monitor	199.00
Grundig 14" Colour TV/Monitor	309.00
Sanyo 12" Green	89.00
Phoenix 12" Hi-Res Amber	129.85
PRINTERS INC. VAT	
Epson RX80	269.00
Epson RX80FT	299.00
Epson FX80	389.00
Epson FX100	569.00
Shinwa CP80	229.00
Riteman	286.00
Juki 6100 Daisywheel	449.00
MISCELLANEOUS INC. VAT	
Sanyo DR101 Data Recorder	39.95
Cassette leads - all types	2.80
Computerama Joystick interface	14.95
Quickshot Joystick (FOR BBC MICRO)	19.95
Printer Cable (Parallel) 1.2 m	9.95
BBC Micro Deluxe Cover	5.95
Light Pen	28.75
Data Cassettes 5 x C20/C15	1.95
The Plug Power Filter	14.95

ORDER A COMPLETE SYSTEM - GET ALL LEADS FREE

CLARES INC. VAT	
B-Base	25.00
Replica II (Disc Only)	12.95
Graph Disc	12.95
The Key (Disc Only)	12.95
Shadow/Inspector	7.95
State 40:80T for Discs	
DR SOFT INC. VAT	
747 Flight Simulator	8.95
Graph	7.95
AMCDM INC. VAT	
Fortress (C,D)	7.95 11.95
Space Highway	7.95
GEMINI GAMES INC. VAT	
Missile Control	9.95
Caterpillar	9.95
GEMINI INC. VAT	
Business Combination Packs 1, 2, 3, 4	P.O.A.
Data Base	19.95
ADVENTURE INTERNATIONAL INC. VAT	
Adventureland	9.95
Voodoo Castle	9.95
Siege Mission	9.95
Pirate Adventure	9.95
SOFTSPOT INC. VAT	
Transitions Revenge	6.95
Hetsi	6.95
H. SOFT (WATFORD) INC. VAT	
Penguin	7.95
ALLIGATA INC. VAT	
Blagger	7.95
HEWSON INC. VAT	
Heathrow Air Traffic Control	7.95
CRL INC. VAT	
Test Match	7.95
A&F INC. VAT	
Chuckie Egg	7.90
Cylon Attack	7.90
AARDVARK INC. VAT	
Zalaga	6.90
MIRRORSDFT INC. VAT	
First Steps With The M. Men	9.95
MICRODEAL INC. VAT	
Air Traffic Control	9.95
Space Shuttle (C,D)	7.95 9.95
MRM SOFTWARE INC. VAT	
Q-Man	5.70
Q-Man's Brother	5.70
Diamond Mine	5.70
Guy In The Hat	5.70
3D Munchy	5.70

FREE with every order, five pounds worth of moneysaving vouchers



Computerama

STAFFORD	STOKE-ON-TRENT	SHREWSBURY
59 Foregate Street Tel: (0785) 41899	11 Market Square Arcade, Hanley Tel: (0782) 268620	13 Castle Gates Tel: (0743) 60528

Patchwork of protection for programs

As far as government legislation is concerned, software and computer programs don't yet exist. As various pressure groups tackle the government on copyright reforms, Simon Elsom examines the state of the law and the tenuous links by which copyright provides protection for software writers.

18

SOFTWARE firms have traditionally protected themselves by licensing their products, as opposed to selling them outright to customers. Before the recent boom in sales of micros, this, together with certain inherent features of software, usually provided effective protection.

Software was almost invariably written for specialist markets, so there was little incentive to copy. Furthermore, the software firm would soon spot any copies because each user (authorised and unauthorised) relied upon it for regular after-sales support.



However, the advent of cheap micros, has vastly increased the size of software markets—and the problem of protecting programs. Software houses increasingly use distributors and dealers, so it is comparatively easy for a dishonest dealer or user to copy and distribute illicit copies of popular software.

Often, though, it is a third party, the romantically-named software pirate, who is copying and distributing the software of others without remitting the royalties rightfully due to them. The pirate cannot be sued for breach of contract, as there isn't one, so the supplier's main recourse in law resides with his so-called 'intellectual property rights', and particularly copyright.

Legal experts, in the UK and overseas, mainly agree that copyright provides the widest protection for software. Many countries have established that computer programs are capable of copyright protection.

For example, three years ago, the US Congress passed an amendment to its 1976 Copyright Act. This contained a definition of a computer program, and established that programs were 'works of authorship' capable of copyright protection.

Case law has gradually explored the scope of this amendment, and it is now becoming accepted in the US that applications and operating systems software, expressed in any computer language and in either a human-readable or machine-readable medium, are capable of protection.

The UK, however, is lagging behind, for many software copyright issues have yet to be resolved here.

UK copyright is attractive because the right exists as soon as the work is created, and there are no formalities to be adhered to. Furthermore, since the UK has ratified both the Berne Union and Universal Copyright Convention, copyright owners can readily obtain protection in most countries overseas.

However, the Copyright Act 1956, on which current UK copyright law is based, was drafted when computing was in its infancy. Nowhere is there mentioned 'computer program', let alone 'software'. Furthermore, no case concerning copyright of computer programs has yet been fully argued in the Court of Appeal or House of Lords.

However, the resulting uncertainty should not be exaggerated. A number of decisions have been made generally indicating that copyright does subsist in computer programs. In addition, out-of-court settlements have been based upon the presumption of protection in such works.

Nevertheless, given that a computer program undergoes a myriad transformation, both in its development and execution in a computer, there are unresolved issues. Among these are: it is not clear which embodiments of a program are capable of protection; and for those that are protected, the scope of the program

copyright owner's exclusive rights is not clear.

In general, copyright does not give the copyright owner the right to reproduce the work, as it may be based upon earlier copyrighted works. Hence copyright prevents others from copying, and thus is more accurately a negative rather than positive right.

Works capable of protection must be included in one or more classes of work specified in the Act: literary, dramatic, musical and artistic. Conditions for the subsistence of copyright together with the copyright owner's exclusive rights are specified for each class.

The basis for the inclusion of computer programs within the Copyright Act 1956 lies in the interpretation of the term 'literary work'. Programs expressed on paper are probably already covered in this class, but some doubt lingers over machine-readable forms of a program (eg, software in ROM and RAM). A literary work is defined in the statute as including 'any written

table or compilation'. The term 'writing' is also defined as including 'any form of notation whether by hand or by printing, typewriting or any similar process'. These definitions can be interpreted to exclude machine-readable forms of a program, or they can equally be interpreted broadly to include such embodiments.

The uncertainty these inadequate definitions create has long been recognised. The government recommended in its Green Paper on copyright law reform (Cmnd 8302, July 1981) to make 'explicit in new legislation that programs attract protection under the same conditions as literary works'.

Furthermore, in the succeeding paragraph the government proposed that 'copyright should extend to works fixed in any form from which they can be reproduced'.

The implication is that programs in a machine-readable form should be protected by copyright, if they are not already

page 22 ►

The Pressure Groups

THE Copyright Reform Group was set up this year to persuade the government to introduce a new copyright law. Its first act was to write a letter to the Prime Minister expressing its concern at the 'apparent lack of progress towards a wholesale revision of what is universally acknowledged to be a seriously outdated Copyright Act'.

Signatories included the Guild of Software Houses, British Copyright Council and the Publishers' Association. There are 16 members of the group. Details c/o Roxburghe House (fourth floor), 273-287 Regent Street, London W1R 8BN. To contact GOSH tel: 01-834 8341.

The Software Registry, launched in April, is a private organisation whose aim is to

establish and maintain the rights of software authors and copyright holders. This is to be done by providing a date verification for members and advice.

The registry is also hoping to stamp out piracy, and is providing an assurance scheme for members caught up in litigation. Cost for the first five years of registration is £75.75, which also covers a year of basic insurance. Details from: TSR, 57a Lincoln's Inn Fields, London WC2A 3LS, tel: 01-430 0798.

The Tape Manufacturers' Group is fighting against the threat of a levy on sales of blank audio and video tapes. This is one suggestion being put before the European Parliament to attempt to curb piracy of music, video and computer tapes.

The Group was formed in 1981 by BASF, Agfa, 3M, Maxell, Memorex, Sony and TDK. Its main thrust is in the music and video industries.

A booklet *The Case Against a Levy on Blank Recording Tapes* is available from the group: Public Relations Office, The Tape Manufacturers' Group, 39-41 New Broad Street, London EC2M 1NH, tel: 01-638 1698.



YES!



"On-board" microprocessor.

Electro magnet to pull motor spindle onto tape.

Nine track "byte-wide" head.

Tape drive spindle.

Precision ground rubber pressure roller.

PHLOOPY 100k cartridge, shown not yet pushed fully home.

Twelve foot long loop of tape freely packed into cartridge.

A 100k BBC-drive for £99 + VAT

We've done it! We've built a storage system for your BBC Micro with the power and convenience of a floppy disk drive, at a fraction of the price. Interface to the BBC costs £26 + VAT and runs up to 8 drives.

PHLOOPY's special secret

PHLOOPY does not record on a disk, but on a loop of quarter-inch tape contained in a rugged interchangeable cartridge.



The heart of PHLOOPY is a unique "byte-wide" magnetic head, that gives it its speed by recording nine tracks across the tape. Typically, you can access a file in only 3 or 4 seconds.

If you're used to waiting for a cassette tape to trundle programs into your BBC, you'll be amazed at PHLOOPY's performance – up to 100 times faster.

Talking to your PHLOOPY

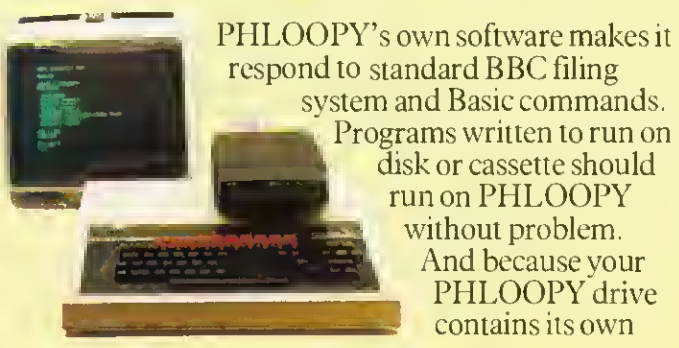

PHLOOPY's own software makes it respond to standard BBC filing system and Basic commands. Programs written to run on disk or cassette should run on PHLOOPY without problem. And because your PHLOOPY drive contains its own

microprocessor – a second computer which does most of the hard work – it puts very little load on the BBC. The on-board computer also checks and automatically corrects any read errors.

Your PHLOOPY Library

PHLOOPY cartridges hold a full 100k of data. You can buy blank cartridges for £3.75 each plus VAT. Many BBC programs will be available on PHLOOPY.



Phi Mag Systems Ltd. PO Box 21, Falmouth, Cornwall TR11 3TD Tel: (0326) 76040

Order Form

- Please send me further details about the PHLOOPY 100k data storage system for the BBC Model B.
- Please send me _____ (qty) PHLOOPY starter pack(s) for my BBC Model B microcomputer, including PHLOOPY drive, BBC interface, leads, connections, operating system in firmware, manual, and two PHLOOPY 100k cartridges, at £147.75 each including VAT, postage and packing. Amount £ _____
- Please send me _____ (qty) packs of 5 PHLOOPY cartridges at £19.75 including VAT, postage and packing. Amount £ _____

I enclose a cheque/PO for £ _____ OR Please debit my
 Access card Number: _____
 Your order will be acknowledged within 10 days, giving a delivery date.
 Name _____
 Address _____
 Town: _____ Post code _____

Send this coupon to: Phi Mag Systems Ltd, PO Box 21, Falmouth, Cornwall TR11 3TD. Telephone: Falmouth (0326) 76040.
 14 day money-back option.

AU

Unicorn. Five new channels. Here's the full

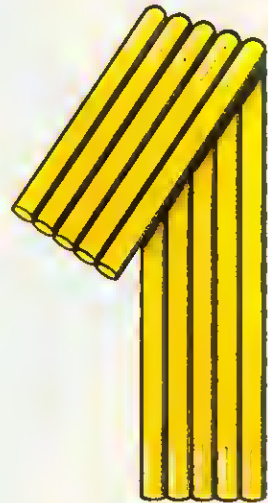

The ZEP 100

- Z80 Extension Processor
- 4MHz Z80A
- 64K RAM
- 24K ROM

The object of any upgrade kit is to improve processing ability and to increase data storage capacity. The UNICORN ZEP100 is the first stage upgrade which opens channels into the world of serious computing.

The ZEP100 is the proven 8 bit second processor for the BBC Model B micro. A Z80 extension processor which enables the use of the well established CPN operating system, giving access to the vast range of applications programs and languages available for all CP/M[®] micros. When fitted to a BBC model microcomputer with compatible high quality disc drives it provides a complete business or scientific computer which can run large applications programs or use advanced languages, with the ability to switch back to standard BBC programs at any time.

Any ZEP100 can be linked, via the Econet[®] option on the BBC, to a network of other TORCH computers to

provide a workstation running on TORCHNE Full TORCHNE operating systems software is provided to

allow access to information anywhere on the network, or to communicate with other computers.

The 64K ZEP100 is supplied with full software support including word processing, spreadsheet, database and utilities. The ZEP100 around \$299 (ex. VAT).

The new UNICORN range from TORCH Computers gives the enthusiast and professional user a choice of upgrades which takes the BBC Model B Micro to the ultimate height of performance.

The result of TORCH'S total commitment to the BBC Micro is the only complete range of high performance hardware available. Offering every BBC Micro owner five new upgrade channels, UNICORN will transform your BBC into a fully communicating workstation, a CP/M[®] compatible business machine or the ultimate in high powered 32-bit data processing.

At the top of the range, THE UNICORN, offers the power and sophistication of System III UNIX[®] whilst other channels make available the flexibility of languages such as FORTRAN, PASCAL, BCPL and COBOL. All models, with the exception of the HDP240, provide BBCBASIC (Z80) on the Z80 rather than the Model B's 6502.

Tune in to the Channel that most suits your requirements. Whichever level you choose you can be sure of a system with infinitely expandable potential for a confident future in the world of computing.



Channels for the BBC. programme.



The ZDP 240

1MHz Z80A ● 64K RAM
4K ROM
16 pin, double sided 400K
floppy discs
Independent integral
power supply



The UNICORN Z80 Disc Pack (Z80 Disc Pack) is the proven upgrade for the BBC Model B micro-computer. Offering the use of more powerful and flexible languages such as Fortran, Pascal, BCPL and Cobol, it provides 800K of disc storage plus a second processor with 64K RAM running TORCH's own CP/M[®] compatible operating system based in ROM. This advanced design means that almost all of the 64K RAM provided by the Z80 board is available for CP/M[®] programming use - an advantage no other BBC micro grade can offer.

If your BBC micro has the Ethernet[®] option, there is a further benefit the ZDP240 can offer. TORCHNET can link together up to 16 upgraded Model B's on a local area network, so for enthusiasts, clubs and Schools it is a simple and low-cost way to achieve networking facilities.

The discs can be used for storage under the Acorn DFS system for CP/M[®] programs and data.

A comprehensive software package is provided with the disc pack. It includes word and data processing and a spreadsheet program, along with utility programs and manuals.

The TORCH Z80 Disc pack is recommended by the CCTA for government use. **The ZDP 240 - around £699 (ex. VAT).**



The HDP 240

- 20Mbyte hard disc Winchester
- Double sided 400K floppy disc
- Integral power supply

For users who need much more storage capacity than is available on floppy discs and who require the large speed gains that a Winchester hard disc provides, the third new channel is now available. The UNICORN HDP240 combines a 400K floppy disc drive with a 20Mb hard disc and its associated controller. The pack connects directly to the disc and 1MHz bus sockets on the BBC Model B.

In conjunction with a ZEP100, it provides a powerful business computer for running CP/M[®] programs with large amounts of data. The floppy disc can be used for storage with the Acorn DFS system, and both discs can be used by other TORCH systems on the TORCHNET local area network. **The HDP240 - around £1995 (ex. VAT).**



The HDP68K

- 8MHz MC68000 ● 6MHz Z80B
- 256K RAM (68000)
- 64K RAM (Z80)
- 20 Mbyte hard disc Winchester
- Double sided 400K floppy disc
- Integral power supply

The fourth channel in the UNICORN range is for users who need the extra processing power of a 68000 32 bit processor, as well as the Z80 running standard software. The UNICORN HDP68K provides the ultimate in performance, offering an extra 256K RAM and a 68000 processor running at 8 million cycles per second. It also contains a Z80 processor to allow the running of existing TORCH software.

The HDP68K - around £2495 (ex. VAT).



The Unicorn

Spec. as HDP68K PLUS UNIX[®] operating system.

UNIX[®] System III is the recognised operating system of the '80's. A very powerful and sophisticated multi-tasking system, it includes a vast library of utility programmes.

The fifth channel and top of the range, THE UNICORN, puts UNIX[®] within reach of the individual user, at a price unmatched by any other UNIX[®] systems, by combining the reliability of the BBC micro with advanced technology from TORCH Computers.

TORCH UNIX operates under the network operating system. Using UNICORN products, a low-cost network of BBC Micros can be configured to offer the most complete range of educational computing facilities available anywhere.

Other facilities available include UCSDp-System, LISP, FORTH, PILOT and PROLOG. **The UNICORN - around £2895 (ex. VAT).**

UNICORN

Open channels for the BBC micro.

To: Torch Computers Ltd., Abberley House,
Great Shelford, Cambridge CB2 5LQ.
Telephone: Cambridge (0223) 841000.

Please send further information on the UNICORN range plus your FREE 1984 Software Catalogue.

Name _____

Address _____



TORCH
COMPUTERS 

CP/M is a registered trademark of Digital Research Inc.
Ethernet is a registered trademark of Acorn Computers Ltd.
Unix is a registered trademark of Bell Telephone Laboratories Inc.

UK version Model B necessary
Disc interfaces are necessary for use with the Unicorn range.

Text and Graphics provided by BBC Model B.
Keyboard provided by BBC Model B.



NO, Acorn isn't going into competition with Virgin has two engines, one behind the cockpit, the other in the front. The Cessna can carry six people, just the equivalent to the Presidential plane. It's a Cessna thing for transporting high-flying millionaires 337 'push me, pull you', so nick-named because it

ITV answer to Ceefax magazine

ORACLE, ITV's viewdata service, is to launch its own computer news and magazine section in June.

The service will be called Database and include news, viewers' letters, events, a games chart and software reviews. The reviews will be done by a special Oracle panel chosen from viewers.

Database will be found on page 558 of Channel 4 Oracle.

Database will be ITV's answer to REM, the magazine run by Ceefax, the BBC's version of viewdata, which has been operating for more than 18 months.

However, there will not be an equivalent to the BBC's Telesoftware Service to accompany the magazine. 'We have no plans to broadcast telesoftware at the moment,' said Oracle editor David Klein.

Now Elk gets Simon sprites

SIMONSOFT has released its *Sprites* package, reviewed last month, for the Electron. It gives generator programs for user-designed sprites, enlargement of up to five times normal sprite size, supersprites of up to 24 x 24 pixels, collision detection, preset flight paths, instant animation and a library of ready-designed images.

The package is claimed to give a 14-fold speed increase over Basic and costs £12.95.

MICROGAME'S *'Dodg'em'* package, reviewed on page 141, costs £5.95.

Teletext mimic for classroom

EDFAX is a teletext emulator for the BBC micro which lets you mimic a teletext database such as Ceefax or Oracle.

Tecmedia, which produced the Input and Microprimer packs for the MEP, are aiming the program at schools that might wish to set up their own teletext system. However, it is also seen as having a role to play for displays in shops or at exhibitions.

Edfax allows users to set up and edit a display, which can be stored on disc and linked to other pictures or text.

The program is provided on disc and up to 80 'pages' can be stored on one 40-track disc. An extensive manual is provided with the program, as well as a disc of example images.

Tecmedia claims that 500 copies have already been ordered by schools in the Midlands where



the software underwent trials.

The Edfax package costs £34.68, but schools will be given a discount on that which amounts to about a third.

Details from Tecmedia at 5 Granby Street, Loughborough, LE11 3DU. Tel: Loughborough (0509) 230248.

Computerised garden

LIVERPOOL'S International Garden Festival will be the testing ground for a computer information system featuring the BBC micro.

The micro will be at the heart of a network of 18 television sets scattered around the 125-acre site, giving visitors information and a catalogue of each day's events.

Information about the Festival

will be input to the system on a Rotavision Editing Station sited in the main hall.

ITM, the company behind the system, is hoping that its development will see much wider application in hotels, airports and railway stations.

For details of the system, contact ITM at E3 New Enterprises, SW Brunswick Dock, Liverpool L3 4AR. Tel: (051) 708 9066.

COPYRIGHT

◀ page 18

protected. However, these recommendations have not been acted on, so the situation is still uncertain.

Although computer programs have yet to be considered in the High Court, they have cropped up, albeit briefly, in *Sega Enterprises Ltd vs Richard* (1983). This case concerned an alleged infringement of copyright in a video game program called *Frogger*, each copy of which was embodied in an EPROM (erasable programmable ROM). The judge said:

'On the evidence before me in this case I am clearly of the opinion that copyright under the provisions relating to literary works in the Copyright Act 1956 subsists in the assembly code program of the game 'Frogger'. The machine code derived from it ... is to be regarded, I think, as either a reproduction or an adaptation of the assembly code program, and ... I find that copyright does subsist in the program.'

Although the judge was unsure which act applied, he was convinced that a machine code form of a copyrighted assembly code program was included in the scope of the restricted acts. This wide interpretation was underlined in the aforementioned Green Paper, for the Government stated that, in its view, the various transformations a program conventionally underwent when run in a computer were already covered.

The effectiveness of copyright law is judged by whether it deters would-be infringers. Clarification of the statute would undoubtedly enhance its effectiveness. However, deterrence also implies a copyright law which is easy and cheap to enforce, and where the remedies granted are punitive in nature. Although the courts have granted what amounts almost to a civil search warrant in software copyright cases, the penalties for infringement are woefully inadequate. In particular, the Act specifies that the guilty defendant should be liable to a fine not exceeding 40 shillings for each article to which the offence relates. An increasing number of organisations advocate a change in the law to increase financial penalties for copyright infringement of computer programs. If enacted, this may do much to deter the ever-present threat of widespread software piracy.

Dr Elsom, a software protection consultant, is secretary of the Copyright Committee, British Computer Society.

M I C R O P O W E R M I C R O P O W E R M I C R O P O W E R

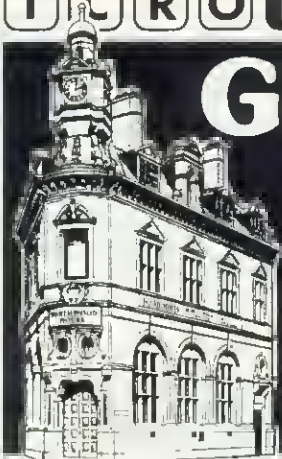

GET ON THE RIGHT TRACK WITH MICRO POWER



Micro Power are an official service and information centre, and we are major suppliers to Government and educational establishments. We stock the complete range of Acornsoft and Micro Power software as well as a wide range of B.B.C. Micro and general computing books. Our expert staff are always on hand to provide advice and assistance in the relaxed atmosphere of our showroom.

COMPUTERS

8.B.C. Model A	325.00
B.B.C. Model B	399.00
B.B.C. Model B plus DFS	469.00
B.B.C. Model B plus Econet	446.00
B.B.C. Model B plus DFS and Econet	516.00
Acorn Electron (phone for availability)	199.00

FOUR FREE MICRO POWER CASSETTES WITH EVERY MODEL B

MONITORS

Philips TP200	78.95
Kaga 12" Green Screen	123.05
Ferguson TX Monitor/TV	335.95
Sanyo DM2112 12" Green Screen	80.95
Microvitec monitor (plastic)	226.85
Microvitec monitor (metal)	228.85
Plinth for above	5.75

DISK DRIVES

Pace 40 track 100K	171.35
Pace 40 track double sided 200K	243.80
Pace 40/80 track double sided 200/400K	282.90
Pace 40 track double drive 200K	388.10
Pace 40 track double sided double drive 400K	483.00
Mitsubishi 40/80 track double sided double drive 400/800K	567.85
Torch Z80 Disk Pack 80 track double sided double drive (including Perfect software)	839.50
AMS HFD 3055 3" 100K (inc. extra ROM)	199.00

ALL PRICES INCLUSIVE OF V.A.T.
We provide free fitting for all firmware.

PRINTERS

Epson FX80	425.95
Epson RX80 F/T	323.28
Mannesmann printer: plus 1000 sheets of paper and cable	279.95
Smith Corona TP-1	270.20
MCP 40	129.95
Juki	446.95

ACCESSORIES

Elftone Digidocord (including leads)	25.95
Acorn 88C cassette recorders (inc. leads)	33.90
Printer paper (2000 sheets)	18.40
Scotch D/S D/D Disks (Box of 10)	32.50
Disk storage cases	21.50
Vinyl dust covers for computers, disk drives, monitors and printers	4.50
Sureshot self centering arcade joystick	18.22
Sureshot self centering double joysticks	34.44
Acorn joysticks	13.00
System Sac	19.95
Printer cables (parallel or serial)	15.50
Stack light pen	28.75
Speech synthesiser plus cartridge socket (Free 1.2 if required)	55.00
Acorn Disk interface (Free 1.2 ROM if req.)	97.00
Pace disk interface kit	95.00
1.2 ROM upgrade	11.50
Econet (Free 1.2 ROM if req.)	70.00
Teletext adaptor (Free 1.2 ROM if req.)	225.00
View wordprocessor (Free 1.2 ROM if req.)	59.80
Wordwise wordprocessor	45.42
Auto Prommers Epron Programmer	138.00
Tutor Mate shelves	10.50
3M unlabelled Disks (Ten)	15.00
Maxell 3" disk	4.95
First Byte Electron joystick interface (inc. cassette)	24.95

ALL ROADS LEAD TO MICRO POWER!



Showroom: Northwood House, North Street, Leeds LS7 2AA, Tel: (0532) 458800
Mail Order: 8/8a Regent Street, Leeds LS7 4PE, Tel: (0532) 683186/696343

Send an SAE for our complete listing of hardware, software and books.

CARRIAGE FREE for BBC, printers, monitors and disk drives. Carriage £5 for Electron. Books and software only 55p per order.

SPECIALISTS IN ECONET



M I C R O P O W E R M I C R O P O W E R M I C R O P O W E R



A **GSL** COMPUTING PUBLICATION

COMPUTING NEWS

GSL'S MONTHLY PRICE REVIEW

MICROS

BBC Model B 32K	£346.96
BBC Model B with D/Interface 32K.....	£433.00
BBC Model B with Econet 32K.....	£389.14
BBC Model B with Disc & Econet 32K..	£480.00

MONITORS

Microvitec 14" Colour	£215.00
Decca 14" Colour.....	£190.00
Kaga Green screen 12"	£107.00
Novex Green & Amber screen.....	£105.00

PRINTERS

NEC PC-8023 BE-N dot matrix	£320.00
Epson FX80 dot matrix	£405.00
Juki 6100 daisywheel printer.....	£399.00

DISC DRIVES

100K Shugart disc drive	£140.00
200K Shugart disc drive	£235.00
400K Shugart disc drive.....	£260.00
Hitach 3" 100K disc drive.....	£180.00

Notice to Dealers

Hitachi 3" Disc Drive
TEC 5¼" 100K Disc Drive

Please contact Rod Lewis or
Glenn Ward for Dealer Prices

UPGRADES

Acorn Disc upgrade Kit	£115.00
Amecom Disc upgrade Kit.....	£115.00
Econet interface Kit	£ 60.82
Speech interface Kit	£ 55.00
Wordwise wordprocessor package	£ 39.00
Disc Doctor pack.....	£ 35.00

BEEBSCOPE

Enables the BBC to function as a two channel, large screen, storage oscilloscope. For scientific, educational or home use.

£350.00

GSL's Monthly Stock Offers

Oric Computer	£110.84
Torch Z80 Disc Pack inc. £1000 free software	£730.00

The above prices exclude carriage and V.A.T.

We are an authorised County Council Dealer
& Service Centre

We are an official Acorn Dealer and Service Centre

Tremendous opportunities for those wishing to become GSL Appointed Dealers

For further details please Contact Rod Lewis on Andover (0264) 59633

namal products *for 1984*

Computers

BBC 'B'	£399.00
Acorn Electron	£199.00
ZX Spectrum 48K	£125.00
ZX Spectrum 16K	£99.00
Oric 1	£139.95
Vic 20 Starter pack	£139.95
Commodore 64	£199.00
<i>Delivery £10.00</i>	

Monitors

Sanyo 14" Green	£86.31
Phoenix 14" Green	£69.00
Phoenix 14" Amber	£72.50
Kaga 14" Amber	£123.45
Kaga 14" Green	£108.00
Kaga 12" Colour	£300.00
<i>Delivery £10.00</i>	

TEAC Slimline Disk Drives

100K (40TPI)	£155.00
200K (40/80TPI) Switchable	£175.00
400K (40/80TPI) Switchable	£240.00
All drives fully cased with cables and format disk.	
Disk with power supply extra	£30.00
<i>Delivery £6.00 per item</i>	

Diskettes

3M	<i>per 10</i>
744 S/S D/D 48TPI	£20.68
745 D/S D/D 48TPI	£28.00
746 S/S D/D 96TPI	£32.00
747 D/S D/D 96TPI	£37.00

Dyson	
S/S D/D 48TPI	£20.00
S/S D/D 96TPI	£29.50

Verbatim	
S/S D/D 48TPI	£20.00
S/S D/D 96TPI	£29.50

Xidex	
S/S D/D 48TPI	£27.50
S/S D/D 96TPI	£34.40
<i>Delivery £1.00 per item</i>	

Cassette Recorders

Sanyo	£28.00
Benkson/Team	£19.00
<i>Delivery £3.00 per item</i>	

**Word-processing:
a complete range of
packages starting at
£899—including VAT
READY TO USE!**

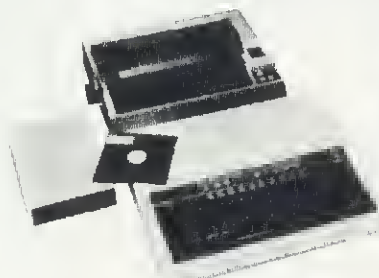

Package comprises: BBC Model B Microcomputer • Wordwise • 100K Disk drive • 80 column printer and free delivery in the UK! • Optional disk drives and printers.

Printers

Epson FX100 FT	£430.00
Epson FX80	£395.00
Epson RX80FT	£315.00
Epson RX80T	£275.00
Seikosha GP100A	£220.00
Shinwa CP80	£275.00
Juki 6100	£395.00
Riteman	£230.00
Mannesman Tally	£225.00
MCP40	£129.95
<i>Delivery £10.00</i>	

Joysticks

Super Champ	£16.95
Mini Champ	£14.00
Quickshot I	£9.95
Quickshot II	£11.95

BBC Joysticks

Emax Professional Joystick	£28.00
Micro Aids Joystick (pair)	£15.00
<i>Delivery £2.00 per item</i>	

We stock a large range of software:

- Games • Educational
- Business

Call for software list and catalogue

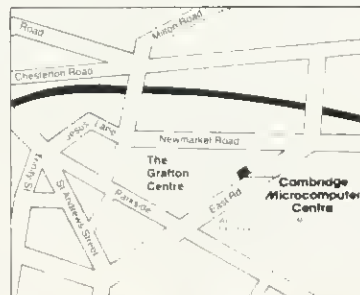

Cambridge Microcomputer Centre is a wholly owned subsidiary of Namal Associates Limited



Ordering is easy: Telephone Hotline (0223) 355404.

All items subject to availability



Type and Talk

Speech Computer RS232 Interface.
Can convert text into speech quickly. Easily programmed. Only £171.35
Delivery £5.00

BBC ROMs

Wordwise	£46.00
Disk Doctor	£33.35
View	£59.80
Graphics Rom	£32.90
<i>Delivery £1.00</i>	

Books

BBC	
Advanced User Guide	£12.95
30-hour Basic	£5.95
Electron	
Take off with the Electron and BBC	£5.95
... and many other books on BBC, Electron, Sinclair and Commodore.	

**COMING SOON!
ACORNSOFT
GAMES/LANGUAGES/
BUSINESS.**

**ALL PRICES
INCLUDE VAT**
Credit terms available
for orders of £500 or over.
Access, Barclaycard, American
Express and Diners Club welcome.

Cambridge Microcomputer Centre

The Peripheral Centre of East Anglia

153-4 East Road, Cambridge CB1 1DD
Telephone (0223) 355404 Telex 817445

BUSINESS BUNDLE

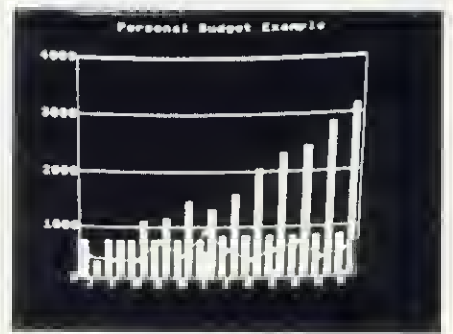

26 What will the Z80 second processor – and the free batch of software that comes with it – do for the Beeb's serious business user?

THE BBC micro has long had the potential to become a business machine and now with the appearance (at last) of the Z80 second processor it has the technology. The Z80 will run CP/M (control program for micros), which has become the standard operating system for running business programs. Software houses all over the world have written programs to run on CP/M machines which, potentially, can run in the 64k provided by the BBC micro with a Z80 second processor.

Acorn has thoughtfully provided a bundle of free software with the hardware. Here the portability of CP/M can be seen, as half of it has come from the US. The programs cover a range of applications, including word processing, filing, financial modelling and writing dedicated software. Three programming languages are included: BBC Basic; Mallard, a Microsoft-type Basic; and CIS Cobol, a business language.

But first let's look at the hardware provided for your £300. The second processor itself comes in the same bland box as the 6502 version reviewed last month, and the Teletext Adaptor before that. It matches the Beeb in colour and finish, being the same depth and height, but half the width. This links to the Tube, Acorn's patented high-speed interface, underneath the Beeb by a short cable, which dictates that the Z80 must sit on the immediate right of the micro. The manual suggests that a desk area of 5ft wide by 2ft 6in deep is needed for the hardware, plus at least four power sockets.

When you open the box you'll find a DNFS ROM provided which is a combined version of the disc and Econet filing systems.

The issue of CP/M is 2.2 with BIOS 1.0 (this is the input/output part of the operating system). Although CP/M is a standard business operating system, there are different implementations on various machines. Acorn is using CP/M under licence from its US owners, Digital Research. CP/M has its own disc operating system, which will handle up to 128 directory entries per disc.

The software comes on seven discs in CP/M format. A list of the major items is given in figure 1, with the companies behind the programs.

The manuals for the software and the

user guide (apart from the standard CP/M manual) were produced by Baddeley Associates of Cambridge, which has an excellent reputation in this area. Its efforts for this package certainly uphold its reputation, most of them being far better than the original guides written by the software houses involved. The manuals have gone through several stages of rewriting and do a good 'hand-holding' job with detailed examples of the software in use. The text examples are backed up by data files on disc that again demonstrate the time and thought that have gone into this package.

Acorn believes that the package will turn the BBC micro into a fully fledged business machine. But how well does this claim stand up? Figure 2 gives some cost comparisons against the Torch Z80 pack and an Apricot. An 800k disc drive is needed to run the system (dual, double-sided, 80-track) and, of course, a monitor. All of that adds up to between £1300 and £1700 (mainly depending on the disc drives).

This is comparable to the Torch and the Apricot, which boasts a much larger

Q/A SESSION

Acorn User probes Howard Fisher, head of the Z80 project, on the capabilities of the system

AU How much CP/M software will the Z80 second processor actually run?

HF Virtually all the CP/M eight-bit software will run. We've tried out as much as we can lay our hands on, including *dBase II*, *Wordstar*, *DRGraph*, and the Perfect and Compact ranges. We are taking a lot of trouble to make sure this does work.

AU Can the Z80 be networked?

HF Yes it is possible, and we are working on it at Acorn. The system will also support Acorn's Winchesters when they become available.

AU Will BBC programs transfer onto the Z80?

HF Yes, you can transfer BBC programs to CP/M. If you have a BBC program (as long as it contains no assembler) it will most likely run on the Z80, so you can take advantage of the CP/M disc filing system, which is much better than the Acorn DFS for random access filing. Data and program merges can give problems, but well-written software will transfer.

AU How well tested is the software and documentation?

HF We have tried it out in small businesses for comments. While it's not exactly 'passed by morons' it should be close to it.

We started off with the idea of modifying the original documentation, but ended up rewriting a lot from scratch. We've put in about two man years of effort humanising the manuals. The *Accountant* guide was written from scratch because Compact did a lot of updating of the original software. The CP/M manual is a reproduction of Digital Research's. We didn't think we could have done anything better. However, for simple uses, the Z80 user guide can replace the Z80 manual.



The second processor, shown with the family of business software, sits to the right of the host micro

memory, better discs, service back-up and a wide repertoire of tried and tested software. However, where the BBC stands out is in the free software which, in the words of Acorn boss Hermann Hauser, the company 'scoured the world for'. All three machines demonstrate the trend towards giving away software to start users off, but Acorn's estimate of £3000 to buy its bundle takes some beating – and it's good stuff (figure 1).

Acorn has kept the price of the Z80 a close secret, and withdrew an original tag

There wasn't time to do a full review of the Z80 software, which will have to wait for another issue, but we can run through some initial impressions (PCW is running a series of reviews based on early versions of the programs).

First, let's tackle *Nucleus*, the 'system generator'. The flexibility of this makes it possible to develop packages at least as good as most of the business programs currently available for the standard BBC micro. The great advantage is that the packages will be customised to the

writer's own use, down to the last field or record. By following Acorn's documentation, the first-time user can be producing worthwhile examples within an hour.

NUCLEUS

The idea behind *Nucleus* is to help users without much programming experience to write custom software. The package is straightforward to use – but what it will not do is the thinking behind how a database should be structured. You must be familiar with the concept of files, fields and records and how they interact. If you aren't, then you're in for a hard time, although working through the examples will give some idea.

Where problems will crop up is in linking files, especially as this topic won't have cropped up unless the programmer has coped with file handling in some depth.

Nucleus gives small firms and dealers an opportunity to create programs and sell them to others. A whole new industry could spring up here, and this is, in fact, exactly where Compact got the idea from (see figure 1). At the moment however, there are no firm plans for Acorn itself to do this.

The ideas offered by Compact in its own leaflets include records covering personnel, schools, medical, stock and invoicing. page 31 ►

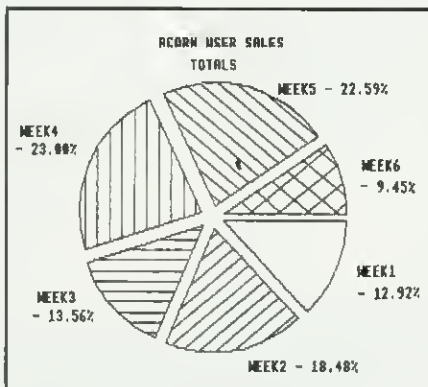

Humble pie? Acorn User does its homework on 'Graph Plan', output on an Epson FX80 printer

of £225 given out a year ago on official price lists. This was no doubt a reaction to the likes of Torch, whose success with products based around Acorn's own boards must be galling. The arrival(?) of Sinclair's QL and the plummeting cost of machines like the Apricot no doubt helped persuade Acorn to keep the price down.

Another option for those who already have a BBC micro is to invest in the 6502 second processor and wait for some quality software to appear. The 6502 is reckoned to be the second-fastest micro-processor in the world and has 22k to play around with in 80-column mode.

Product	Originator	Description
Accountant	Compact Accounting Services (UK)	Nominal Ledger
Nucleus	Compact Accounting Services (UK)	Database creation
Memo Plan	Chang Laboratories (US)	Word processor
Graph Plan	Chang Laboratories (US)	Spreadsheet with graphics
File Plan	Chang Laboratories (US)	Data filing system
CIS Cobol	Microfocus (UK)	COmmon Business Orientated Language
Animator	Microfocus (UK)	Cobol debugging utility
Forms 2	Microfocus (UK)	Cobol screen layout utility
Z80 BBC Basic	Acorn/BBC	Disc version to run under CP/M
Mallard Professional Basic		Microsoft-type Basic
CP/M 2.2 with GSX graphics	Digital Research (US)	Z80 operating system

All the software comes contained on seven discs, with separate guides to each. The discs also contain sample data for some of the programs.

Figure 1. Z80 software bundle

BBC Z80 system running CP/M 2.2	
BBC micro with disc interface	£470
Dual 80-track disc drives (800k)	£450-£800
80-column monochrome monitor	£100
Z80 second processor	£300
Total cost	£1320-£1670
Estimated value of software inc.	£3000
Torch Z80 system running CP/M	
Total cost	£1409
Estimated value of software inc.	£1000
Apricot running CP/M 86 and MS-DOS	
16-bit processor, 256k RAM, twin single-sided 3½in disc drives (730k), separate keyboard, monitor	
Total cost	£1890
Estimated software inc	£750

Figure 2. Three-way cost comparison of hardware/software combinations.

If you're studying... Study our Software

We've been producing educational software for the BBC micro ever since it was launched, and our programs are in use in schools and colleges all over the country. Now, some of these programs have been specially adapted for you to use at home.

With our **Understanding Science** programs you can get to grips with subjects in Biology, Physics or Chemistry that you didn't understand, or supplement your practical work by doing simulated experiments on the computer. These programs are suitable for age 13+ and are ideal if you are studying for those all-important exams. The emphasis is on **understanding** the subject and the programs come with a detailed explanatory booklet. The first programs are ready now —

with many more to follow.

Chemistry — Symbols, Formulae and Valency

Chemistry — Chemical Equations

Chemistry — Inorganic Analysis and Identification of Gases

Physics — The Oscilloscope and Waveform Analysis

The Human Body — Heart and Kidney

Each package costs £12.95 (cassette) or £13.50 (disc).

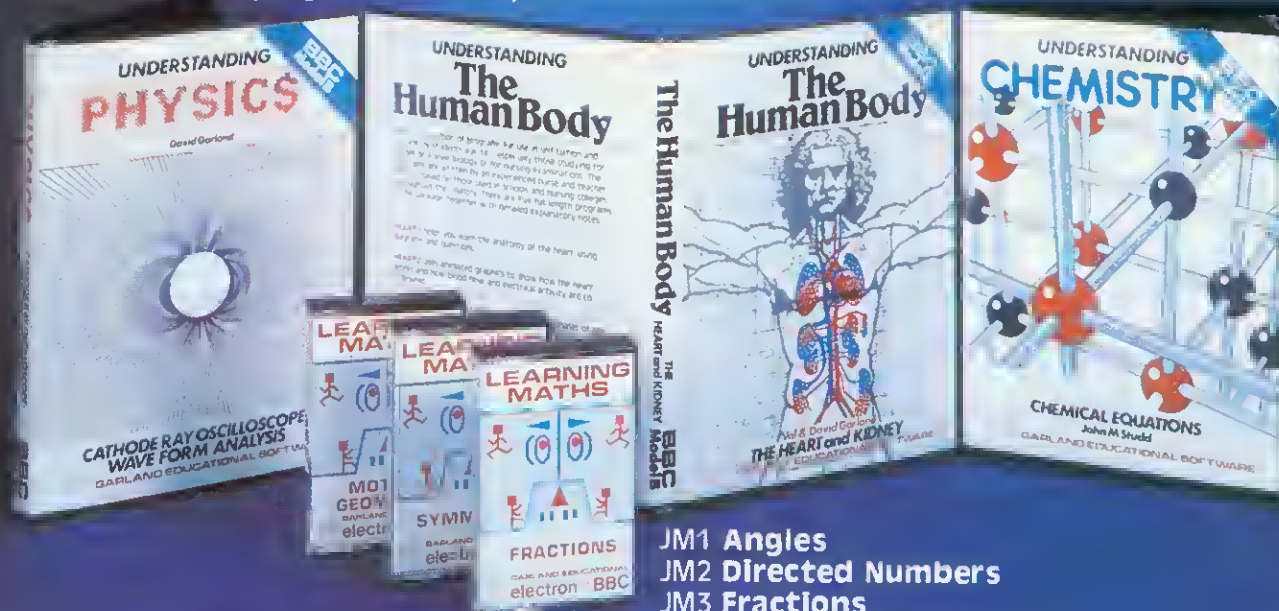

For younger pupils age 9+, our **Learning Maths** programs use simple games and animations to illustrate important principles of elementary Maths. There are nine titles — each containing three or more programs covering a particular concept. The programs are great fun to use — as well as providing real educational value.

Nine cassettes are available*

JM1 Angles

JM2 Directed Numbers

JM3 Fractions

JM4 Co-ordinates and Lines

JM5 Symmetry

JM6 Motion Geometry

JM7 Sets

JM8 Elementary Statistics

JM9 Ratio

Each cassette costs £7.00. Disc collections also available (JM1-6, £30.00; JM7-9 £18.00)

*Electron versions of programs JM1-9 and Dragon versions of JM1-6 also available.

Available by direct mail order, or from selected software dealers.
Prices include VAT and P&P (in UK).



Garland Educational Software, 20 North Hill, Gwynedd, PL2 8AN, Tel. 0300 500000

Little Brothers should be seen but not heard.



A maxim which eloquently describes the Brother HR-5.

Less than a foot across, it's nonetheless loaded with features.

But there's one thing the HR-5 won't give you. Earache.

For the annoying 'clickety clack' many printers produce is mercifully absent from the HR-5.

Quietly efficient, it delivers high definition dot matrix text over 80 columns at 30 c.p.s.

The HR-5 also has something of an artistic bent.

Being capable of producing uni-directional graph and chart images together with bi-directional text.

It will also hone down characters into a condensed face, or extend them for added emphasis.

Incorporating either a Centronics parallel or RS-232C interface, the HR-5 is compatible with

most home computers and popular software.

Perfectly portable, the battery or mains operated HR-5 weighs less than 4lbs, and has a starting price of only £179.95 (inc.VAT).

Which is really something to shout about.

PLEASE SEND ME MORE DETAILS OF THE REMARKABLE BROTHER HR-5 PRINTER. AU 6/84

NAME _____

ADDRESS _____

TEL NO. _____



CHESHIRE CAT **EDUCATIONAL SERIES** from **AMPALSOFT**

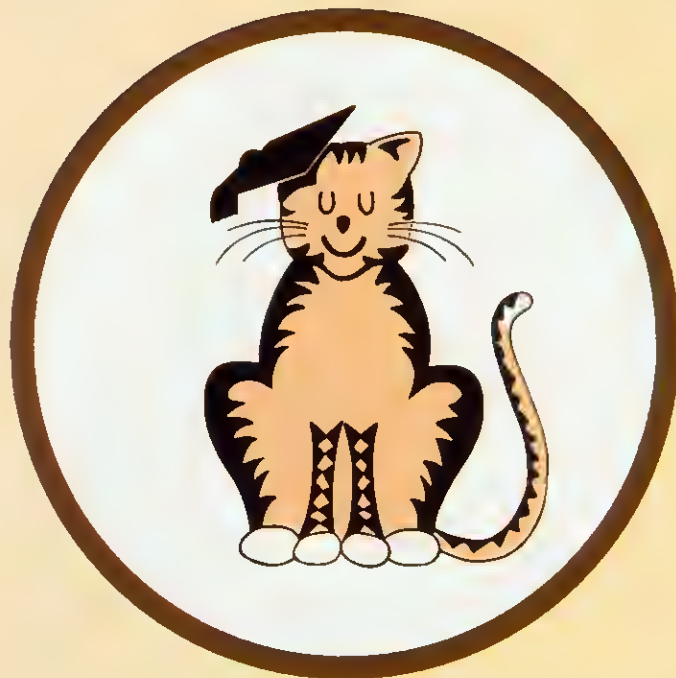

CHESHIRE CAT

The First name in Educational Software.

An exciting range of top quality programs
Available for BBC, Electron, Dragon 64, Dragon 32.
Available shortly for Commodore 64, Spectrum 48K.

RETAILER ENQUIRIES WELCOME

Ampal Computer Services Ltd.,
31 Woodbridge Road, Darby Green, Blackwater,
Camberley, Surrey.
Tel: (0252) 876677.

Available from selected branches



Boots, W. H. Smith and Dragon Data Ltd.
and other good computer stores

COMPACT NUCLEUS			FILE DEFINITION										
SYSTEM NUMBER			21 SCHOOL RECORDS										
FILE NUMBER			1 STUDENT FILE										
BASIC FILE NAME			SSFILE01										
FILE TYPE			Master										
RECORD LENGTH			220										
NUMBER OF RANKS			1										
NUMBER OF RECORD TYPES			1										
FILE PROTECTION			None										
FIELD NO.	DESCRIPTION	FIELD TYPE	NUMBER OF CHARACTERS	DIGITS BEFORE POINT	DIGITS AFTER POINT	ALLOW NEGATIVE VALUES	MINIMUM VALUE	MAXIMUM VALUE	NUMBER OF LINES	DELETE PROTECT	START BYTE	BASIC LTH	NAME
1	STUDENT CODE	Numeric		4	0	N					1	2	DAZ
2	NAME	Alphanumeric	30						3		3	90	DA\$
3	ADDRESS	Alphanumeric	30						4		93	120	DB\$
4	FORM NUMBER	Numeric		3	0	N					213	2	DB%
5	DATE OF BIRTH	Date									215	4	FD!
6	ABSENCE TO DATE	Numeric		3	0	N					219	2	DC%
KEY NO.	KEY DESCRIPTION	NUMBER OF CHARACTERS	RANK NO.										
1	STUDENT CODE	4	1										

Example from the user manual of a database devised with Compact's 'Nucleus' package

◀ page 27

GRAPH PLAN

Probably the easiest and friendliest of the whole bundle. It's a spreadsheet with the rare ability to give graphical representation of its rows and columns as pie-charts, bar-charts and graphs, without any heartache. It is set up for the Epson FX range of printers (although it does strange things with the Star Delta, which has the same control codes). Other printers will be supported.

This is the only piece of software in the package that supports colour.

The maximum number of cells supported is 1000 as 50 rows by 20 columns, the size of each being definable within this limit. The figures in these cells can be manipulated as in any other spreadsheet. The split-screen facility of Visicalc is not supplied.

MEMO PLAN

Memo Plan is a word processor. One of its main features is that it automatically saves text every few minutes, and the user can carry on working as this happens. Two documents can be displayed on the screen at the same time, the display being split horizontally, and another three can be held in memory and called up to replace one of the two on the screen.

The use of function keys is just as comprehensive as *View's*.

Memo Plan does not support continuous processing, so you have to stop typing while the screen is being printed out.

One of the big advantages of *Memo Plan* over the likes of *View* and *Wordwise* is that it is set up to cope with long documents. At the start of a typing session space can be reserved on disc for the equivalent of, say, a 50-page document, and the manual explains how to work out the memory required.

The system is configured for the Epson

printers as a default, although another 20 are covered, any of which can be selected.

Docuplan is an addition to *Memo Plan* that can cope with long indexes and can format text. It will be available at about £150.

ACCOUNTANT

'Simple but flexible' is the description in the manual for this program, which has three main parts: sales daybook, purchase daybook and cashbook. These can then be built up into a nominal ledger. However, *Accountant* is one of the heavyweights in the bundle and has already earned itself a good reputation on other micros. Compact has substantially expanded the software from the original version, improving its credit-handling side.

It is aimed at the small shopkeeper and the system can be built up using other packages available from Compact to cover invoicing, sales ledger and bought ledger.

VAT reports are generated from within the daybooks, and up to 10 different rates can be entered. Companies that prepare budgets are also catered for.

Users who do not have accounting skills will be pleased to find a glossary at the back of the *Accountant* guide, but even so, transferring a complete paper system onto the package would be no easy matter. Acorn is apparently arranging training courses for dealers, who may set up similar help for customers.

FILE PLAN

This is what is known as a 'viewsheet', in other words a database presented as a number of record cards on the screen. It is similar to a spreadsheet, but with words instead of numbers filling the cells.

The whole thing is menu-drive, with options for sorting and updating records. Files created on *File Plan* can be printed

out, or used to produce labels by linking to *Mail Plan*, a complementary part of the package.

BASIC

Two versions of Basic are provided. One is a version of BBC Basic which runs on CP/M, the other is Mallard, a more standard Microsoft-type Basic.

The BBC Basic on disc leaves about 40k, in any mode, for user programs. It is close to the 6502 version, but there are differences, which are outlined in the Z80 user guide. Commands can be passed to the 6502 operating system, but these are checked for as Z80 commands first.

Utilities are included to change BBC discs to CP/M format.

CIS-COBOL

The Cobol is provided by Micro Focus, and comes with *Animator*. Using this debugger enables Cobol programs to be stepped through line by line and checked for errors. Cobol, a widely used language for writing business programs, enables input to be tightly defined, although this does make it long-winded to use. *Forms 2* is a screen layout facility.

GSX is a graphics package that is not actually used by any of the bundled software. It is designed for use with the Digital Research *Graph* package, which can be bought from computer dealers.

To sum up, Acorn has put together an excellent and versatile system that has something for everyone. The level of the packages varies, some demanding a high standard of knowledge and expertise, others being easy to get into. The value of even one of the packages could justify its cost to a buyer. Certainly it gives an excellent introduction to the world of CP/M and gives the would-be computerised businessman a foundation on which to build an excellent system.

PROFESSIONAL SOFTWARE FOR THE BBC MICRO

EASIPILOT

EASIPILOT is a sophisticated AND user friendly graph package for the BBC Micro, placed 14th in the top 20 Educational packages by the leading Educational Computing Magazine. EASIPILOT has also come to be regarded as an 'outstanding business package' and 'excellent value for money'.

Note:- EASIPILOT 3 comes complete with the number charting program DATA PLOTTER with graph magnification, colour and moving average facilities. SUPERB VALUE AT £22.95.

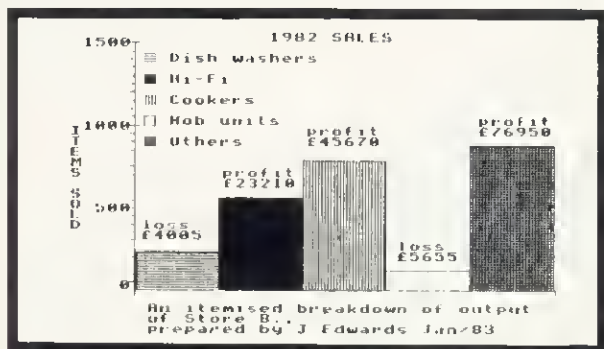

EASIPILOT FACILITIES

Line, Bar and Pie Charts
Auto & Manual Scaling
Grid & Scatter Options
No of simultaneous graphs
Overwrite memory
Screensave facility
Screendump facility
Fixed description per graph (char's)
Full plot and axis editing
Save, Load & *CAT facilities
Single file selection
Operating Manual (pages)

DISK CASSETTE

YES YES
YES YES
YES YES
5 3
YES NO
YES YES
YES YES
up to 200 100
YES YES
YES YES
YES NO
52 52

SHARE ANALYSER

SHARE ANALYSER is a sophisticated portfolio reporting and share analysis package designed for the small investor. The disk version has a capacity of 20,000 SHARE PRICES and up to 320 buy/sell deals covering 20 share names. Share Analyser has facilities for profit flexing and multiple merging of graphs and a variety of selectable indicators. **SHARE ANALYSER IS A MUST FOR THE INVESTOR AT A BARGAIN PRICE.**

PROFIT STATEMENT

NAME BRITISH PETROLEUM

DEALINGS		
Bought	Av Price	Cost
600	338	2028
Sold	Av Price	Income
300	426	1278
Held	Curr Price	Mkt Valn
300	438	1314
	Gross Profit	564
	Income	257
	Expenses	101
	Net Profit	720
	% Gain	= 36

SHARE ANALYSER FACILITIES

No of prices stored
Max no' of Holdings
Transactions per holding
Range, adjuster
File Manager
Printer Manager

DISK CASSETTE

20,000 Appx 1700
20 20
16 16
YES NO
YES NO
YES NO

REPORTS PRODUCED:-

Portfolio Valuation	YES	YES
Portfolio Profit Analysis	YES	YES
Share Profit Analysis	YES	YES
Share Movement Analysis	YES	YES
Transaction Record Report	YES	NO
File Status Report	YES	NO

GRAPHICS FACILITIES:-

Magnification option	YES	YES
Grid	YES	YES
Autoscale	YES	YES
Screendump	YES	YES
Screendump	YES	YES

SELECTABLE GRAPHICAL INDICATORS:-

Lagged Moving Average	YES	YES
Centred Moving Average	YES	YES
Rise and fall indicator	YES	YES
Weekly/Daily Low indicator	YES	YES
Superimpose Facility	YES	YES

All our programs will produce hard copy on the following printers:- EPSON (entire range), Shinwa CP80, Star DP 510, Seikosha (GP80A & GP100A). Share Analyser will produce reports on any BBC compatible printer.

PLEASE NOTE:- Our programs CANNOT BE OBTAINED FROM YOUR LOCAL DEALER so send for details NOW.

PROGRAM	PRICE
Data Plotter (cassette) . . Model B & Electron	£7.00
Data Plotter (disk) . . Model B	£8.00
Easiplot 1 (cassette) . . Model B & Electron	£15.95
Easiplot 2 (disk only) . . Model B	£19.95
Easiplot 3 (including Data Plotter-disk only)	£22.95
Share Analyser (cassette) . . Model B & Electron	£14.95
Share Analyser (disk only) . . Model B	£19.95

Disk orders . . please state 40 or 80 track (add £1 for 80 track and £1.50 for overseas orders). We will upgrade Easiplot 1 to Easiplot 2 for £7 (£10 to Easiplot 3).

Write for full specifications of all our programs or leave your name and address with our Answerphone service (Luton 33858).

All programs are normally despatched within 24 hours.

Send cheque/P.O. etc to

Synergy Software, 7 St Andrews Close, Slip End, Luton. LU1 4DE.



Your Beeb –

with everything

in its place

FOR something slightly different, here's a simple project to build a simple computer tidy and a portable box to contain a complete BBC computer system.

The computer tidy will keep your computer and cassette recorder or disc drive looking tidy, provide a suitable monitor support and avoid the need for constantly disconnecting leads. It is constructed from two pieces of softwood and two pieces of white-faced chipboard (the sort sold for shelving), and can easily be dismantled if required.

The sides are made from $6 \times \frac{7}{8}$ in planed softwood as shown in diagram 1. The curved parts can be cut with a jigsaw or coping saw. Once cut and sanded, they look most attractive if varnished and contrast well with white-faced chipboard. The correct length for the chipboard will depend on the width of the computer plus the width of the cassette player or disc drive. Remember to allow extra length for the leads to come out of the cassette. For the BBC cassette, allow an extra 2in at each side for the mains lead and the signal lead. The BBC computer is 16in wide and the BBC data recorder is $10\frac{1}{2}$ in. On this recorder the mains lead is at one side and the signal lead at the other, so an extra 4in needs to be allowed for the leads, so the minimum width of the tidy is $30\frac{1}{2}$ in. A reasonable width to cut the chipboard would be 32 inches.

Most disc drives are 6-8in wide, and so a tidy for a system with a disc drive should be about 24in wide. Check measurements carefully before cutting any parts, and check that there's enough height if using double disc drives. Some might be too high to fit into the computer tidy with the measurements given.

The sides can be joined to the white-faced chipboard by using 'harpoon' fixings. These can be obtained from good hardware shops and are designed for chipboard fixing. They are very strong, consisting of a hexagonal socket screw and a special nut that opens up inside the hole in the chipboard like a harpoon.

Martin Phillips dons carpenter's overalls to produce a computer tidy and carrycase for the Beeb ... plus circles, strings, spikes

Once fitted, the screw can easily be removed and replaced without affecting the strength of the joint. Harpoon fixings are expensive but make assembly easy. The ends of the white-faced chipboard do not need finishing as they are covered by the sides of the tidy. To prevent the computer and cassette sliding about, glue battens behind them. You can do this with the computer and cassette in position.

At the back of the lower shelf a multi-socket adaptor can be screwed to keep all the wiring neat and tidy. Lastly, four self-adhesive rubber feet need to be stuck under the base. If constructed as described above, the tidy is strong enough to support a monitor or portable TV. It also puts the monitor in an ideal position.

The computer box is similar in design but enables the computer to be packed away quickly and moved without having to disconnect everything. It also provides good protection for the computer. Rather than using chipboard, the box is constructed of softwood and good-quality 9mm plywood. There is no need for the harpoon fixings; the joints are glued with woodworker's adhesive. This is stronger than the wood, and saves any screwing or nailing.

The box has a compartment at the back with a miniature multi-socket mains connector (the kind commonly used to connect up stereo systems) and there is room for all the leads to be stowed. The box will also support the weight of a monitor.

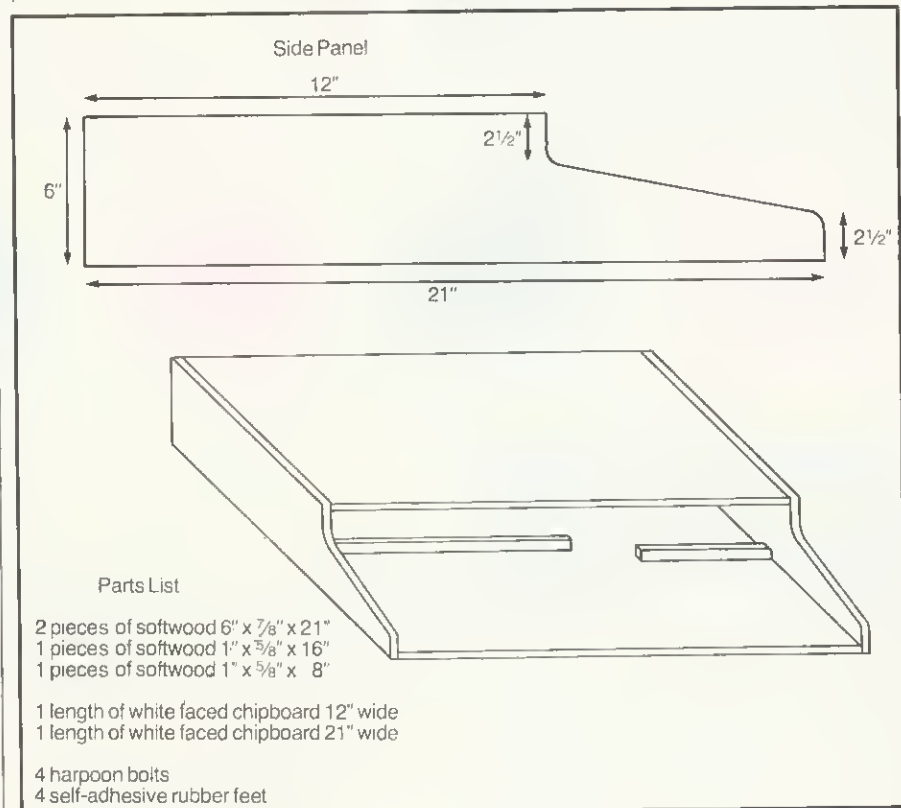
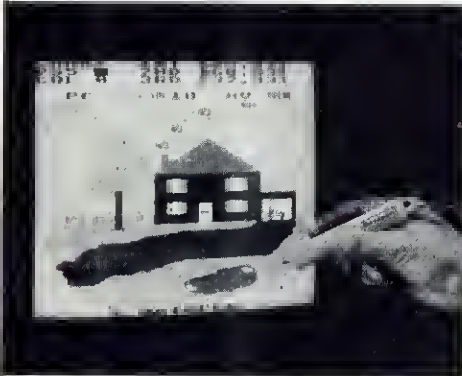

Diagram 1. Simple computer tidy

IF YOU have a technical hitch or a programming problem let Martin Phillips give his diagnosis. We'll pay £5 if you raise a really interesting point. Please give full details of the system you're using and include a listing where appropriate, making your question as specific as possible. WRITE TO: Hints & Tips, Acorn User, Redwood Publishing, 68 Long Acre, London WC2E 9JH.



BEEB PEN DRAWING PROGRAM
A comprehensive Mode 2 colour drawing program allowing plot commands, painting, circles, text, character defining, saving and loading to tape or disc, all to be selected and used with the lightpen.
PRICE £11.95 Introductory Offer £9.95



TELETEXT DISPLAY CREATOR/EDITOR
Allows the busy programmer to quickly create Mode 7 colour graphics and test screens for combination into his or her own programs. Movable on screen menu allows use of complete screen for graphics. Full instructions and a discussion on teletext features are provided. **PRICE £9.95 Introductory Offer £7.95**



BRITAIN
The first in a series of educational Geography and Geology programs. Britain comes complete with three sets of tests, and these may be very easily changed by adding DATA statements in the Basic program. Full instructions and grid map supplied.
PRICE £6.95 Introductory Offer £5.95

SUPERIOR PERFORMANCE

- Intensive to ambient lighting
- Responds to different colours
- Program accessible LED lamp readout
- Switch for program control



SUPERIOR PROGRAMS

- Tape storage of your work
- Good documentation
- User routines provided on tape and on printout

The Datapen Lightpen itself comes complete with handbook, software on tape including two drawing programs and a printed listing showing useful routines.

PRICE £25.00

Two drawing programs, SKETCH and SHAPE-CREATE are included with the lightpen and the programs shown above may be ordered additionally, or separately as required.

All prices above include VAT, postage and packing.

Please send your cheque/P.O. to:-
Dept. 4, Datapen Micratechnology Ltd., Kingsclere Road, Overton, Hants. RG25 3JB

E·N·I·G·M·A Can you break the code?



CONTROL



ACCEPT?

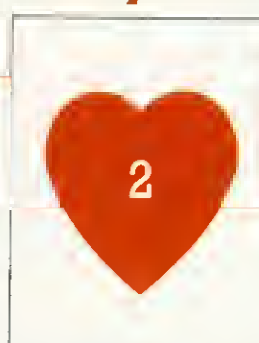

REJECT?



ACCEPT?



REJECT?

ENIGMA is a new type of computer game. In most games you have a set of rules. In these games it is the other way round. The game will be over when you discover the rule by which it is being played. The computer will accept or reject cards - your objective is to discover the rules. There are five rules in all - but don't be discouraged - the games can be solved - if you have enough imagination and perseverance.

Available on cassette with full instructions for the BBC 'B', Electron and Spectrum machines, at £9.95 including VAT, post and packing. When you've solved all the five games return the cassette with £4 to us and we'll send you another.

Dealer Deals Ltd, 20 Orange Street, London WC2H 7ED
Access card holders ring 01-289 2188 24 hours.

To Dealer Deals Ltd, 20 Orange Street, London WC2H 7ED

au5

Please state machine _____ Please rush me an Enigma cassette.

I enclose a cheque/P.O. for £9.95 payable to Dealer Deals Ltd or debit my

Access card No. _____ Signature _____

Name _____ Address _____

Postcode _____

The front of the box lifts off to expose the computer keyboard and cassette or disc drive. The sockets at the back of the computer are all accessible from the compartment, and the ones most frequently used have been brought out at the side of the box, which saves wear and tear on the computer sockets. The new sockets are wired to plugs, which then go into the computer sockets, so the computer does not need to be touched. In my case I have brought out the RGB, cassette and analogue port sockets. A printer lead can remain attached to the computer and be disconnected at the printer end and stowed in the box for transportation.

As the box needs to be small enough to be carried, it is not as deep as the computer tidy. This is why plywood is used rather than chipboard, which is too heavy. Again, the exact width of the box will depend on the dimensions of the disc drive or cassette player. Thought must also be given as to how the cassette or disc is to be held in place when the lid is in position. As my disc drives are almost the exact internal height of the box I simply glued a thick foam pad inside the lid to hold them down when the lid is closed.

The catches need to be strong, and they must be well fastened to the box to stand up to the strain. If using a single disc

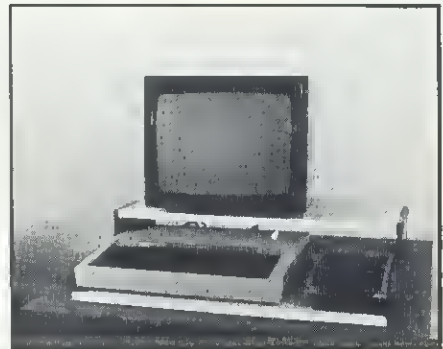

drive or a cassette, it might be better to fit a shelf to raise the disc or cassette up. The space under the shelf could be used to hold the *User Guide*.

There is an internal partition separating the lead compartment from the computer. The computer is held at the back by a batten glued to this partition. The cutouts in the partition allow access to the computer sockets and the mains switch and clear the ventilation slots at the back of the computer. There is a cutout at the back so that leads can be passed out of the box, and a handle is screwed to the back (this needs a metal reinforcing plate inside the box).

The lid has a batten at the front to hold the computer in place. This rests on the front of the computer in front of the space bar. Do not make the batten too large or it could damage the space bar. Once the lid has been removed, the computer is easy to take out. The lid is fastened to the box with removable hinges and stout suitcase catches.

Once complete the box can be varnished or painted, and rubber feet stuck onto the front of the lid and under the base. The measurements are a guide only and you must check that your system will fit. My apologies to those readers who prefer to work in metric, but most of the wood sizes have not yet been metricated!

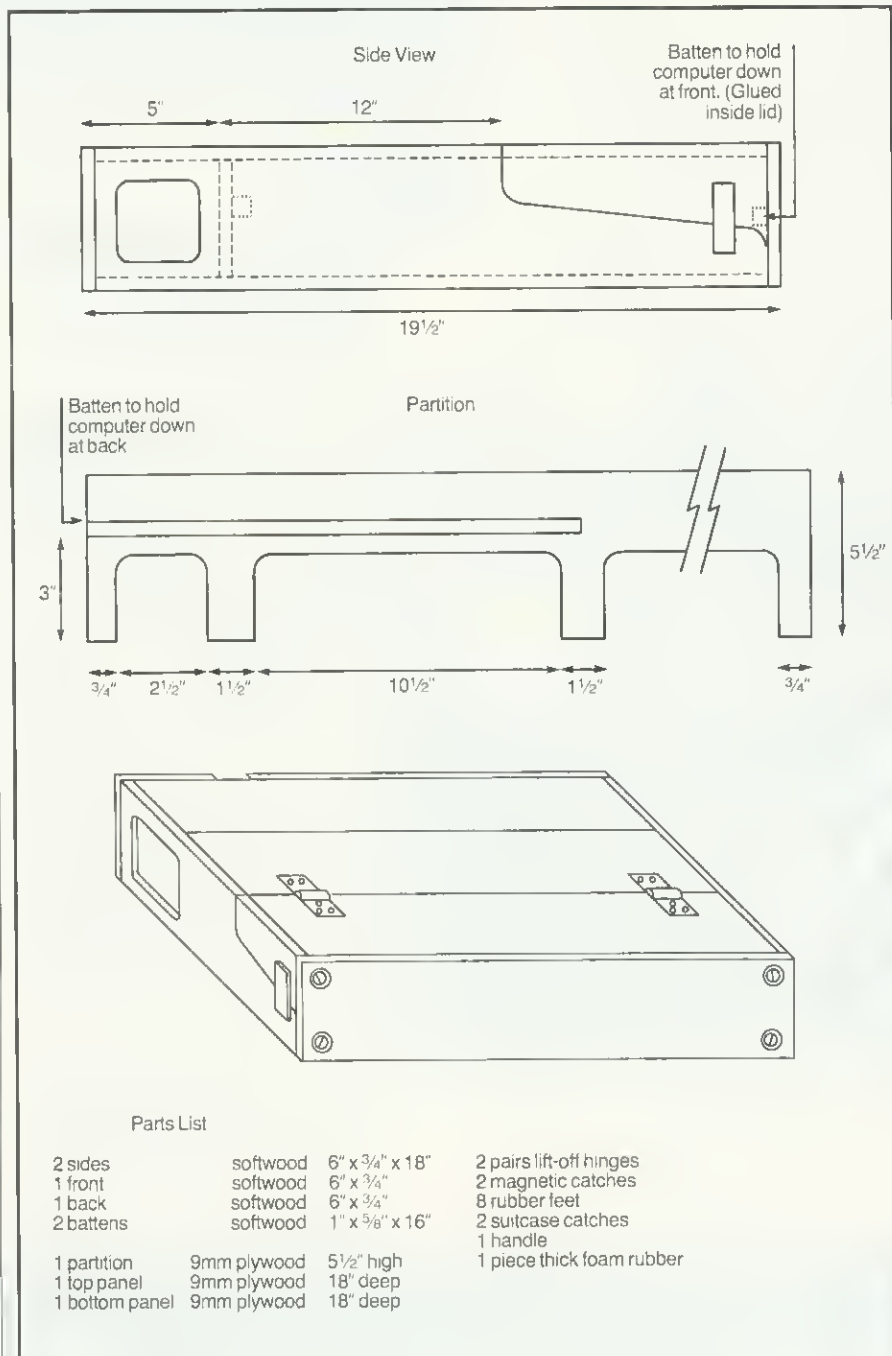

Diagram 2. Portable box for Beeb system

Worth buying

a disc drive?

MANY schools have now received their half-priced DTI BBC computers complete with disc interface and a somewhat useless Econet interface. The question frequently raised by teachers in such schools is: 'Is it worth buying a disc drive?' As this is a problem also facing home users, especially now that drives are available over the counters of many high street stores, it is well worth airing here.

Many users are frustrated by the cassette recorder and think a disc drive is the answer to all their problems. I have listed some of the advantages of both storage systems and highlighted some of the problems associated with disc drives.

Caretaker

£33.35 incl.

CARETAKER is a BASIC utility ROM which provides many new invaluable commands to help the BASIC programmer. Because CARETAKER is in ROM, it uses no BASIC program space and its commands are always instantly available. Some of the CARETAKER commands are detailed below:

- ***EXCHANGE** - provides a search and replace facility, either global or selective. 'Wildcard' characters and BASIC keyword tokens may be included.
- ***EXPAND** - Lists a program in an easy-to-read form, also allowing 'squashed' programs to be read.
- ***INSERT** - Enables BASIC routines on disc or tape to be inserted into or added to the program in memory.
- ***KEYLOAD** and ***KEYSAVE** - Load and save the function key definitions.

- ***LVAR** - Lists the values of all or some of the variables.
 - ***MERGE** - Will merge one or more BASIC programs on file into the program in memory.
 - ***MOVE** - Allows the current BASIC program to be moved to a new page in memory.
 - ***PARTSAVE** - Saves only a selected section of a BASIC program (useful for later merging).
 - ***RENUMBER** - Renumbers parts of BASIC programs and moves the renumbered section as necessary.
 - ***RETRIEVE** - Restores a corrupted program to a form in which it can be listed and edited.
 - ***SINGLEKEY** - Enables BASIC keywords to be entered quickly, as on the ELECTRON.
 - ***SQUASH** - Reduces the size of a BASIC program in order to save memory space. A very efficient routine.
 - ***STATUS** - Displays the values of PAGE, HIMEM, program length, bytes free, etc.
 - ***TABSTOPS** - Provides a tabulation facility. Up to eight tabstops can be defined.
- CARETAKER is supplied with a spiral bound manual, special 'single-key entry' stickers for the key fronts, and easy-to-follow fitting instructions. A full specification is available upon request.

```
CARETAKER 1.00
CURSOR (ON/OFF)
EXCHANGE <old> <new> G/S (<length>)
EXPAND (<start>) (<end>)
INSERT <fsp> (<line no>)
KEYLOAD (<fsp>)
KEYSAVE (<fsp>)
LVAR (F) (I) (S) (A) (P)
MOVE <address>
MERGE <fsp> (<fsp>) ...
NORMALKEY
NOTAB
PARTSAVE <fsp> (<start>) (<end>)
RENUMBER (<lst> <inc> <start> <end>)
RETRIEVE (<bytes>)
SINGLEKEY
SQUASH (S) (R) (M)
STATUS
TABSTOPS (<columns ...>)
```



New Release



The Most Popular Word Processing ROM for the BBC Micro £46.00 incl.

WORDWISE is ideal as an introduction to word processing for the beginner, but is a powerful enough tool to be used seriously by professional authors (at least two of the most popular BBC Micro magazines are prepared entirely with WORDWISE). Being entirely ROM based it occupies none of the memory which is used to store text. It will operate fully on cassette, disc or ECONET (level III). It is not specific to any particular printer, nor does it require a special printer-driver (an expensive extra on some word processors). WORDWISE allows any codes to be sent to any printer, at any point within the text, by using a simple 'embedded command'.

For the beginner, text can be typed straight into WORDWISE and saved, loaded, previewed or printed immediately. Once experience is gained, commands may be added to control the final layout on paper. Some of the layout or 'formatting' commands are described later. At any time whilst the text is being entered or edited a word count is displayed continuously on the top line. Labelled function keys provide the user with simple controls to mark any section of text and then delete, move or copy it to any other position. Characters can be quickly converted between upper and lower case; changing case of entire paragraphs is equally simple.



Moving around the text is simple. Cursor keys alone move one position in any direction; CTRL and cursor keys together move in larger steps, a word left/right, a page up/down; SHIFT and cursor keys move as far as possible to the right/left of the line or to the start/end of the entire text. These movements are so easy to use that many other programs have adopted exactly the same method.

Formatting commands include the ability to split the document into pages of any length, with or without headings or footings. Page numbers may be printed automatically within the text, including within headings and footings. Commands are provided to set (at any point in the text) line length, left margin, tabulation positions, line spacing etc. Text can be centred on a line, indents and temporary indents can be set and cancelled. Output can be made to automatically pause at the end of a page, e.g. for a single-sheet feed. Right-justification of text can be turned on and off at any points in the text.

User-defined keys may hold any required string as normal and used within WORDWISE, including the codes required to induce key-operations such as cursor movement.

ARIES compatible WORDWISE

A new version of WORDWISE is available upon request at the standard price which is fully compatible with the ARIES B20 RAM board. When fitted alongside the compatible WORDWISE, the ARIES board allows text to be previewed in 80-columns even with the normal RAM full of text. An upgrade from the standard version of WORDWISE is available. Please ask for details.



No doubt readers who have recently changed to discs will be able to enlarge this list. It is not meant to put the reader off disc drives, but I hope it will give a better insight into the problems that will need to be overcome.

Advantages of disc

1. A program loads much quicker from disc, almost instantaneously.
2. Many programs can be stored on one disc.
3. It is easier to find what programs are stored on disc.
4. It gives the advanced computer user a useful extra range of facilities, and opens up new techniques.

Advantages of cassette

1. A cassette recorder costs less than £30 to buy and requires no special interface. A disc drive costs from £170 upwards and requires a disc interface to be fitted (another £100+). A disc interface is a collection of chips that plug into some of the spare sockets on a model B computer to enable a disc drive to be connected. One of the chips that deserves special mention is the DFS (Disc Filing System). It is a clever chip that performs all the 'housekeeping' tasks required on the disc. Several different makes of DFS are available, each with its advantages and limitations.
2. A blank C15 cassette costs about 50p, whereas a blank disc costs £2 – although a disc will store far more information. This price difference is reflected in the cost of commercially available software on disc or cassette.
3. Cassettes can be handled quite roughly and still work, but discs need careful handling if they are not to be damaged.
4. A cassette player can be repaired comparatively cheaply if it goes wrong, whereas a disc is a piece of precision equipment and is expensive to repair. Only a few dealers will undertake repairs to disc drives; most will need to send them back to a service agent.
5. Broken leads are a common problem. It costs £2 for a new cassette lead, but £12 for a new disc lead, and this requires fitting by a dealer.
6. The cassette socket on the computer is more robust than the disc connector. The latter can be easily damaged by careless handling.

'Hidden' problems of disc

1. A disc drive has an extra set of commands, which give it versatility but also add to the problems of understanding an already complicated machine.
2. To operate, the disc drive uses some of the BBC's memory space. This leaves less for the user, so some long

programs designed for cassette will not work on a disc machine, although the problem can be solved with time and a little knowledge.

3. Which disc system do you go for? Forty-track or 80-track, single or double-sided, single or twin drive, or even one of the new 3in drives? Each has its advantages and disadvantages, but they are not interchangeable. Do you rely on the BBC's power supply to drive it, or invest in a more expensive drive with its own power supply?
4. Many cassette programs are now protected and cannot be transferred to disc.
5. Discs can be corrupted so that you are unable to retrieve the programs from them. This can happen if the disc drive is switched off at the mains while the disc is still in the machine. The information stored on the disc cannot be retrieved without a great deal of trouble and expertise if this happens. Many of the newer types of disc drive have virtually overcome this problem, but some makes are worse than others in this respect.
6. Discs need to be formatted before use. This is done with a program, usually supplied with the disc drive.

Going round

in circles

IT WOULD have been useful to have a routine built into the computer to draw circles and ellipses. T Poole of Glasgow has written to ask how circles can be programmed, and I've received several other letters asking for ways to speed up circle drawing.

There are several ways of drawing circles. The first is called the iterative method, and as it is not easy to see how the method works, attempting to alter it can produce odd results.

The second method uses the equation of a circle. The equation of a circle about the origin is $X^2 + Y^2 = R^2$. This would be programmed as $X*X + Y*Y = R*R$ where X is the horizontal co-ordinate, Y the vertical co-ordinate and R the radius. Rearranging this equation, we get $Y = \text{SOR}(R*R - X*X)$. Thus if we know the radius and use set values for X, we can find the value of Y.

Listing 1 (yellow page i) shows how this can be done. Line 20 sets the time to 0. Line 40 moves the graphics origin to the centre of the screen. Line 50 sets the radius of the circle to 400. Lines 60 to 130 need to be repeated twice, first to draw the upper (positive Y) half of the circle, and then to draw the lower (negative Y) half.



Line 100 makes Y negative if T=1. The step length for X is set in line 80 to a value of 8. Line 90 calculates the value for Y, and line 110 draws a line from the last point to the new co-ordinates.

To draw an ellipse, all that is needed is to multiply either the X value or the Y value by a factor somewhere between 1 and 2.

The program can be speeded up by using integer variables instead of real variables (an integer is a whole number and can be positive or negative, whereas a real number can contain a fractional part). Listing 2 shows how this can be done, and also uses a neater method of making Y negative. A small saving in time can be made by doing any repeated calculations only once.

Listing 3 moves the squaring of the radius outside the loop to save a little time. More time can be saved by entering the equation to find the value of Y% directly into the DRAW statement. And yet more time-saving can be made by decreasing the number of points plotted.

The circle retains its shape provided the step size is not larger than 20 (listing 5). The step size for any particular circle will change depending on the screen mode used and the size of the circle. It will be a compromise between the quality of the circle and the speed of drawing. Table 1 gives a comparison of speeds on both the Electron and the BBC.

	ELECTRON	BBC
Circle 1	12.06 sec	3.91 sec
Circle 2	10.32 sec	3.29 sec
Circle 3	9.97 sec	3.17 sec
Circle 4	9.92 sec	3.08 sec
Circle 5	4.12 sec	1.29 sec
Circle 6	10.48 sec	3.41 sec

Table 1. Comparison of speeds

British Disc Drives direct from the manufacturer



- BBC compatible ● Metal case
- Dual drive ● Switchable 40/80 track
- Complete with utilities disc – manual and cables
- The only 5 1/4 in. drive designed and manufactured in Britain

5 1/4 single sided dual unit 400K **£279**

5 1/4 double sided dual unit 800K **£349**

For box with power supply add **£30**

Carriage **£8**

Access & Barclaycard accepted

Prices exclude V.A.T.

Data Track Technology
The U.K. source for 5 1/4 in. disc drives



Data Track Technology Limited,
7 Queensway, Stem Lane Industrial Estate,
New Milton, Hampshire, U.K., BH25 5NN
Tel: (0425) 619650 Telex: 47674

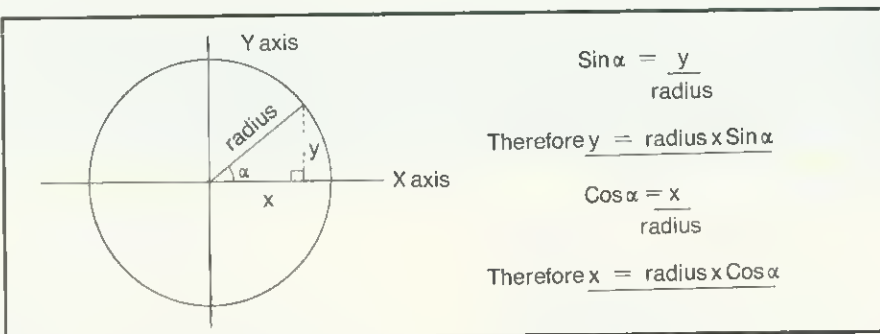

Figure 1.

The third method of programming circles uses polar co-ordinates. Listing 6 gives an example of a circle drawn using polar co-ordinates. These are not as difficult as might at first seem. Instead of there being 360 degrees in a full circle, there are $2 \times \pi$ radians. The rest is standard trigonometry (figure 1).

Strings in store

AN ARRAY is an arrangement of items of data, each identified by a key or subscript. Mr Thompson of London has sent in a program that uses string arrays (that is, arrays which store letters or words rather than just numbers). The program works for so long and then comes up with a 'No room' error.

The problem is rather obscure and concerns the BBC's and Electron's method of storing string arrays. The way Mr Thompson's program has been designed it puts names into an array and occasionally changes them. When the names are changed for longer ones the program will sooner or later run out of room.

Unlike some computers – the Spectrum, for instance – the BBC and Electron don't need the length of each string variable in an array to be specified when the array is dimensioned. This means that when the string variables in an array are stored in memory, only the exact amount of room is allowed as it is stored. Then if the string is redefined and the new string is longer than the old one it has to be stored elsewhere in memory. The old space is just left unused.

If then there is little memory left at the end of a program, and the strings are subject to change in length, the computer can run out of memory because of the space wasted. This is demonstrated by listing 7.

The program defines an array 100 variables long, and then stores a one-character string in each variable. (Remember that the first string variable of the array is A(0)$.) Then the program stores a two-character string in each variable – and so on until it runs out of memory. On the Electron or a disc-based BBC it runs out of memory when $T=52$, and on a cassette-based BBC when $T=61$. The difference is accounted for by the different

modes each computer works in and the different amounts of memory then remaining.

The cure is easy. Decide on the maximum length of the longest string variable in the array and then define dummy strings to reserve that amount of space. Listing 8 shows how this can be done to save an array 100 variables long, each string variable having a maximum length of 20 characters. The dummy string in this case is a series of asterisks, but you could make them any character you like.

25
LETTER
25

STEVE OSTLER of London was inspired by George Hill's series on printers to write a four-colour screen dump for the Seiko-sha GP-250X (listing 9). It takes 10-15 minutes to dump, but this could be speeded up by using more integer variables (see the item on drawing circles). Also the dump prints sideways and will not print the bottom two lines of the screen.

Mains spikes

I HAVE received an interesting letter from Chris Beesley of Cheadle, prompted by February's article on cassette loading. He has echoed many of my suggestions made in this column in the March issue and also suggests that the cassette be run off batteries to avoid recording clicks caused by mains spikes. These are frequently caused by electrical equipment switching on elsewhere. Appliances with powerful motors such as washing machines and fridges (as well as strip lights) are particularly prone to cause spikes – ever noticed the TV picture jump when one of these appliances is switched on? N A Hird has similarly found that programs can be corrupted by mains spikes.

There are two solutions other than resorting to batteries. One way is to record each program twice. Then if one block will not load, wind the tape on to the second copy and carry on loading from there. The

Beeb will allow you to wind and rewind in the middle of a program and will carry on loading from the point at which it was interrupted. There is no need to load from the start of the program again.

The other way is to buy a special device called a mains transient suppressor. Maplin Electronic Supplies of Rayleigh, Essex, sells a small device for less than £1 that has a very high resistance at 240 volts, but the moment a spike appears on the supply line which exceeds the peak level of the mains voltage the impedance of the device drops immediately to a very low level, dissipating the unwanted energy. The device is so small that it can easily be wired across the live and neutral terminals of the cassette player mains plug.

It is wise to insulate each lead of the suppressor with plastic sleeving. Make sure the component is carefully fitted so that there is no risk of it or its leads being accessible from outside the plug or shorting to any other terminal. Mains voltages are dangerous and care is always needed. The appliance must be unplugged from the mains before starting.

In and out of ROMs

I WAS interested to read Joe's Jottings in *Acorn User* (March) about sideways ROMs (see also Beeb Forum). There can be problems where one ROM interferes with another. When two ROMs have common commands you should disable the offending ROM so that the command can be used with the other ROM. A ROM can be disabled by poking a particular memory location for that ROM. To disable a ROM in the sideways socket type

?&2A1 + (ROM socket number) = 0

where the ROM socket number is the number of the socket where the ROM is situated, and can take a value between 0 and 15. Zero is the left-hand ROM socket looking from the front of the computer, and 3 will be last.

To switch the ROM back in again type

?&2A1 + (ROM socket number) = 255

I expected to encounter a problem when I bought the new Basic II chip to replace my existing Basic I. I wanted to be able to switch between either version of Basic to test out programs on both. I was pleasantly surprised to find that both can reside in the sideways sockets without interfering with each other! The BBC treats them as different languages. I put the Basic II chip in the socket before Basic I so my machine will normally use the later version. When I wish to use Basic I simply type

*FX142, (ROM socket number)

Similarly I can reselect Basic II again.



Watford Electronics

Dept. BBC, CARDIFF ROAD, WATFORD, HERTS. ENGLAND.



Tel: Watford (0923) 40588/37774

Telex: 8956095 WAELEC



BBC MICROCOMPUTER

Model A—£260; Model B—£346

Upgrade your Model A with our Upgrade Kits and save yourself £ s s s

- 88C1 16K Memory (8 x 4816AP-3 100ns) **£24.00**
- 88C2 Printer User I/O Port **£8.10**
- 88C3 Disc Interface Kit **£95.00**
- BBC4 Analogue I/O Kit **£8.25**
- 88C6 Expansion Bus Kit **£7.75**
- Complete Mod. A to 8 Upgrade Kit

ELECTRON MICROCOMPUTER

£199 (incl. VAT)

Dust Cover for BBC Micro

Protects your expensive Micro from foreign bodies. **£3.50**

SEIKOSHA GP100A PRINTER

10" Tractor Feed, 80 columns, 50CPS, Normal & Double width Char, Dot res graphics. Parallel Interface Card.

SPECIAL OFFER Only: **£144**

INTERFACE CABLE

88C to Seikosha Cable **£7**

FRICTION FEED

Attachment for GP100A or 250X Printers **£28**

GP-700 Colour Printer screen-dump routine in ROM FOR BBC Micro **£12**

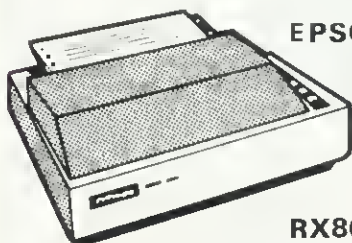

EPSON

RX80

100 CPS, 9 x 9 matrix, dot addressable graphics, condensed and double width printing. Normal, Italic and Elite Graphics. Tractor feed, 10" max width, bi-directional, logic seeking. Centronics Interface standard.

ONLY **£235** (£7 carr.)

EPSON RX80 F/T PRINTER

As above but has both Friction and Tractor Feed. **£259** (£7 carr. Securicor)

PRINTER INTERFACE BUFFER

Neatly packaged self contained box, supplied complete with all leads, manual and detachable power supply.

Price: 16K Unit **£99**
Price: 48K Unit **£135**

Epson FX80 Printer

160 CPS, 11 x 9 matrix, proportional spacing, superscripts, subscripts, dot addressable graphics. Normal, Italic and Elite characters. Up to 256 user definable characters. Down loadable character set. Condensed and double width printing. Full proportional spacing. Four user defined margin positions. Tractor and Friction feed. 10" maximum width Bi-directional, logic seeking Centronics interface standard

ONLY **£324** (£7 carr.)

Epson FX100 Printer

Same as FX80 but has a 15" wide Carriage **£495**

Type	Ribbons	Dust Covers
MX80FT	£4.75	£4.50
MX100/FX100	£10.00	£5.25
FX80	£4.75	£4.95
RX80	£4.75	£4.50
GP80	£4.50	—
GP100	£4.95	£3.95
GP250	£5.95	£3.95
GP700	£18.50	—

RX & FX PRINTER INTERFACES

RS232	£35	RS232 + 2K Buffer	£59
IEEE 488	£65	2K Parallel	£58

BROTHER HR-15 DAISY-WHEEL PRINTER

An exceptionally high quality daisy wheel printer at the price of a dot matrix printer. 18CPS; bi-directional, 3K of buffer; has clear buffer facility, carriage skip movement, proportional spacing; underlining; bold print and shadow print. Prints in two colours; super and subscript facility. Impact control facility to vary pressure on paper for making carbon copies. Has Centronics parallel or RS-232 Interface. Connects directly to 88C Micro. A ribbon cassette plus a separate red ribbon. Optional extras: single sheet feeder takes up to 150 A4 sheets; a keyboard that transforms HR15 into a sophisticated electronics typewriter. Attractively finished in beige.

ONLY **£349**

Single Sheet Feeder **£199**
Keyboard **£150**
Ribbon **£3**; Daisy Wheel **£18**

LISTING PAPER (Plain)

1,000 Sheets 9 1/2" Fanfold Paper	£7
1,000 Sheets 15" Fanfold Paper	£9
Teletypewriter Roll (Econo paper)	£4

PRINTER LABELS (continuous stationery)

1,000 90 x 36mm	£5.50
1,000 90 x 49mm	£7.75
1,000 102 x 36mm	£6.25
Carriage on Printer Paper or Labels £1.50	

PRINTER LEAD 36"

Ready made printer lead to interface 88C Micro to EPSON, SEIKOSHA, NEC, STAR, JUKI, BROTHER, SHINWA, etc., Printers.

ONLY **£7**

Special Extra long 5 feet Cable **£10**

BBC Micro WORD-PROCESSING PACKAGE

A complete word processing package consisting of: BBC Model 8, Zenith 12" Green or Amber Monitor, Twin 200K highly reliable (1 year warranty) Teac Disc Drives in matching beige colour, the popular WORDWISE word processor, Watford's own highly sophisticated 62 File interface fitted, the world renowned Brother HR15 Daisy Wheel Printer. Gemini's Beebpl Beebcalc Spreadsheet Analysis Software disc, 10 blank diskettes, 500 sheets of fan-fold paper, Manuals and all the leads. To enable you to take your Micro around, we shall pack it in our Antique Brown leatherette Attache carrying

ONLY **£1,275** (carr.)

(P.S. We will alter the package to suit your requirement. Call in for a demonstration).

NEW

KAGA KP810

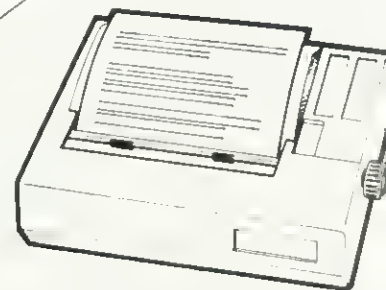

This new JAPANESE printer has EPSON FX/RX compatible commands. 140 CPS Dot matrix Printer, offers NEAR LETTER QUALITY printing 9 x 9 matrix. Friction feed. Adjustable tractor feed, Single sheet feed and built-in Paper Holder. Normal, Italic, Enlarged Condensed Super and Subscript. Dot addressable graphics (8, 9 and 16 pin modes). Proportional spacing (Optional extra: Down loadable character set 18K ROM or RAM). NEAR LETTER QUALITY print, selectable at switch on. 10" maximum width, bi-directional, logic seeking. 3K Buffer. Half speed quiet mode. Convenient Paper-out sensor switch. Centronics Interface standard. This plus our no quibble 12 months warranty.

Special Introductory Offer: ONLY **£2**

KAGA KP910 PRINTER

Similar features as the above KP810 printer but has extra wide carriage. Will accept upto 17" maximum width paper 156 column normal and 265 column condensed

ONLY: **£3**

AMS 3" DISC DRIVES

These popular mini disc drives, now available from WATFORD. For details see AMS advert in this magazine. Supplied complete with cables, manual and utilities disc.

Single 100K per side **£1**
Twin 200K per side **£3**

DISC DRIVES CASED WITH CABLES (less PSU)

(All Drives are NEW SLIM-LINE Type)

NEW LOW PRICES

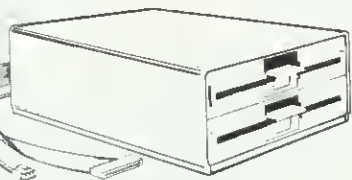

- LS 100** Single, TEC Single sided 40 track 200K, 5 1/4" Disc Drive **£129**
- LS400** Single, Mitsubishi Double sided 80 track 400K, 5 1/4" Disc Drive **£188**
- LS400S** Single, Mitsubishi Double sided 40/80 track Switchable, 400K, 5 1/4" Disc Drive **£215**
- LD200** TEC Single sided 40 track 200K, in 5 1/4" Drives **£252**
- LD800** Mitsubishi Double sided 80 track 400K, 5 1/4" TWIN Drives **£365**
- LD800S** Mitsubishi Double sided 40/80 track switchable, 800K, Drives **£399**

ACORN (MANA) DRIVES CASED WITH PSU & CABLES

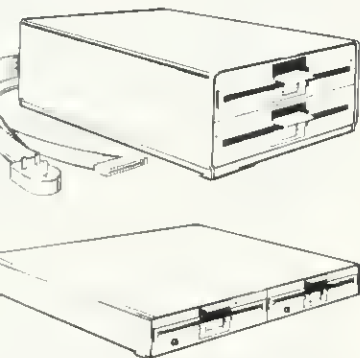

- S100** TEC Single sided 40 track 100K 5 1/4" Single Disc Drive **£145**
 - S200** TEC Single sided 80 track 200K 5 1/4" Single Disc Drive **£210**
 - S400** Mitsubishi Double sided 80 track 400K 5 1/4" Single Drive **£259**
 - S400S** Mitsubishi Double sided 40/80 track 400K 5 1/4" Single Drive **£340**
 - D200** TEC Single sided 40 track 200K 5 1/4" TWIN Disc Drives **£275**
 - D400** TEC Single sided 40 track 200K 5 1/4" TWIN Disc Drives **£365**
 - D800** Mitsubishi Double sided 80 track 400K 5 1/4" TWIN Drives **£425**
 - D800S** Mitsubishi Double sided 40/80 track switchable 800K TWIN Drives **£465**
- PSU DRIVE CABLES, SINGLE **£6**; DUAL **£9**
 DFS Manual (comprehensive) **£7.50** (No VAT)

You do not require Formatting Discs when using our DFS as the formatting program is in ROM, nor do you require expensive 40/80 track switchable drives as with our DFS you can read and write 40 and 80 track discs in an 80 track drive (software switchable).

MITSUBISHI SLIMLINE DISC DRIVES that supply are Double Sided, Double Density 1 Megabyte. (With 88C Micro 400K after formatting.) When used in conjunction with a Double Density board one obtains 800K (approx) after formatting. Track density 96 TPI, track to track access time 3mSec. These drives are very quiet and efficient. We strongly recommend their use.

5 1/4" DISKETTES

(Lifetime warranty)

Why settle for less, Buy the best.

- 10 Verbatim or 3M Diskettes S/S D/D **£17**
- 10 Verbatim or 3M Diskettes D/S D/D **£27**

DISC ALBUMS

Attractively finished in beige leatherlook vinyl. Stores, protects and displays 20 discs in double-sided clear view pockets. **ONLY £4.95**

PLASTIC LIBRARY CASES

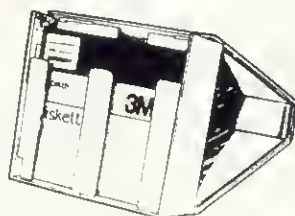

for Disc Storage 5 1/4" (holds 10) **£2**

LOCKABLE STORAGE UNITS

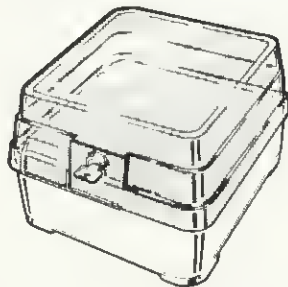

Attractively finished, strong beige plastic base fitted with dividers. Smoke acrylic top. Equipped with adhesive title strips for ease of filing.

- M-35 Holds upto 35 mini discs **£16**
- M-85 Holds upto 85 mini discs **£20**

FLOPPY HEAD CLEANERS

Unless your office/home is dust free, you should clean heads at least once a week to avoid the risk of cross contamination. Simply apply the cleaner to one of the specially formulated cleaning discs, insert into the drive and initialise. If your system has no initialisation program then insert the disc and open and close the door 5 times.

£16.00

READY-MADE LEADS

- CASSETTE LEADS 7 pin DIN Plug to 5 pin DIN Plug + 1 Jack Plug **£2.00**
- to 3 pin DIN Plug + 1 Jack Plug **£2.00**
- to 7 pin DIN Plug **£2.50**
- to 3 Jack Plugs **£2.00**
- 6 pin DIN to 6 pin DIN Plug (RGB) £2.50**
- Monitor Lead, 8NC to PHONO **£3.00**
- Disc Drive to 88C Micro Power Lead Single: **£3.00** Dual **£3.75**

MISCELLANEOUS CONNECTORS

- | | Plugs | Sockets |
|-----------------------|-------|---------|
| RGB (6 PIN DIN) | 30p | 45p |
| RS423 (5 pin Domino) | 40p | 50p |
| Cassette (7 pin DIN) | 25p | 65p |
| ECONET (5 pin DIN) | 20p | 30p |
| Paddles (15 pin 'D') | 110p | 215p |
| BBC Power Plug 6 way | 75p | - |
| Disc Drive Plug 4 way | 70p | - |

EPROM PROGRAMMER for BBC MICRO

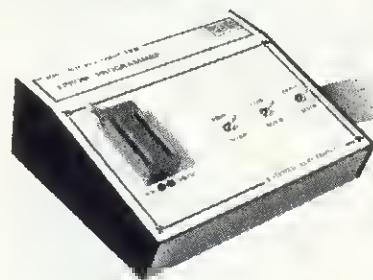

At last! - the EPROM Programmer for BBC Micro Computer from WATFORD ELECTRONICS that will suit both your pocket and all your requirements. Programs all popular types of EPROMS from 2K bytes up to 16K bytes - **2716 - 2516 - 2532 - 2584 - 2764 - 27128.**

This extremely powerful system is designed for your needs of TODAY & TOMORROW! - BBC Basic programs can be copied into EPROM and subsequently re-loaded faster than from a disc! Suitable for both hobbyist and professional users!

Just look at these features:

- **COMPLETELY SELF CONTAINED** - Housed in its own sturdy case - Uses its own power supply - connects directly to the 1MHz Bus - Simple and Safe!
- **FULL SOFTWARE SUPPORT** - Comes complete with simple to use fully machine code ROM based software and easy to understand manual. Facilities include Verification, Reading, Virgin Testing, Writing, Editing, Saving, Loading and more! NOTE!! - This software does not simply comprise hastily prepared routines to get you going, but is a professional, purpose designed applications package.
- **ACORN BUS COMPATIBLE** - Use of the 1MHz connection complies with all Acorn addressing recommendations - That means you can still add-on such things as the TELETEXT, IEEE 488 TUBE and PRESTEL
- Allows more than one program to reside in an EPROM using the ROM Filing System.

ONLY £79 incl. Manual (£3 carr)

MONITORS

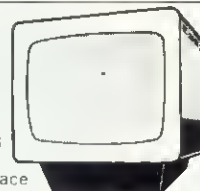

MICROVITEC 1431
 14" Colour Monitor, RGB Input (as used in 88C programmes) FREE Interface Lead **Special Offer £179**

- **MICROVITEC 1451** Hi-res 14" Monitor incl. lead **£295**
- **NEW MICROVITEC 14"** Colour Monitor/Composite Video **£249**
- **KAGA RGB 12"** Medium Resolution Colour **£195**
- **KAGA RGB 12"** High Resolution Colour **£259**
- **KAGA 12"** Standard resolution colour MONITOR/COMPOSITE VIDEO **ONLY £195**
- **BNC** Connecting Lead **£3**
- **RGB** Connecting Lead **£5**
- **ZENITH 12"** High resolution, jitter free picture, Amber or Green **£75**

Carriage on Monitors £7 (Securicor)

SWIVEL MONITOR BASE



Attractively finished in beige, our swivel base allows you to tilt/swivel your Monitor to any required angle for comfortable viewing.

ONLY £18

Continued →

NEW
Mk II 13 ROM SOCKET BOARD

Now all lines fully buffered - On board battery back-up facility - will now accept EPROMs 2716, 2732, 2764 & 27128 and ROMs 6116 & 6264.

Simply plugs into one of the four ROM sockets currently available in BBC Micro. There are only 5 solder connections to be made. Full instructions are supplied. This board has been ergonomically designed to enable the user, easy further expansion inside the Micro, e.g. Double Density Board, Torch Board, etc. (At Watford, we think ahead.)

Our 13 ROM SOCKETS BOARD enables the User to increase the Sideways ROM capacity the basic four sockets on the main board up to the full SIXTEEN capable of being supported by current operating systems. In addition the board is designed with the facility to hold up to 16K RAM, which when switched into operation is automatically selected by any WRITE signal to the Sideways ROM area. This gives the User the ability to write a utility or language and upon pressing break have the utility or language up and running (new ROM software can be developed and tested in situ.)

The Board gives the User, plenty of freedom to explore the possibilities of the new paged ROMs due in the coming months and offers them the chance to develop their own.

All lines are fully buffered and the Board meets or exceeds all timings for operation in the BBC Microcomputer. When fully populated, the ROM Board consumes less than half the recommended maximum current limit.

Supplied ready-built and tested complete with fitting instructions.

ONLY £32.50 (carr. £1)

**EPROMs & CMOS RAMs
for BBC MICRO**

2764-250nS (8K ROM)	£5.95
27128-250nS (16K ROM)	£24.00
6116-150nS (2K RAM)	£5.75
6264-150nS (8K RAM)	£36.00

**BEEB SPEECH
SYNTHESISER**
VERSATILE SPEECH SYNTHESISER
UNIT FOR THE BBC
MICROCOMPUTER



Watford Electronic's very own Speech System. Specially designed so that even a novice can make his BBC talk:-

SIMPLY the best! - An unlimited speech synthesis system. Complete with easy-to-follow manual. Controlling software is in ROM so no Cassette Loading problems!

PHONEMES for word synthesis - That means unlimited vocabulary! No extra speech dictionary chips to buy!

BUILT-in Library of approximately 500 words to get you started.

ENGLISH accent - Utilises inflexion techniques to produce highly comprehensible speech.

EASY to use system - Just plug the software ROM into a socket, the Speech unit into the User Port, and away you go! No specialised 'dealer upgrade' required!

COMPACT unit - The whole system is built into a small case - easily tucked behind the computer. Auxillary output socket provided for direct connection to an external amplifier.

HOURS of fun! - Suitable for any application - Games, Educational Programs, Specialised Packages.

We know this all seems to good to be true but DON'T BE LEFT SPEECHLESS! Order your Versatile Speech Unit now!

Only £44

**THE ULTIMATE DFS
FOR BBC MICRO**

by



Highly acclaimed at The ACORN and BBC MICRO USER Shows. What do the independent press say?

Good value for money - *Beebug Aug. '83*
A very worthwhile package - *The Micro User*
You'll be buying a very powerful package - *Personal Computer News*
Superior DFS: Excellent disc sector editor - *Computer Answers*

Without a doubt, the most sophisticated DFS Software yet written for BBC Micro Computer. This powerful new DFS is fully compatible with ACORN DFS yet has much increased power due to additions, carefully designed to make life easier in normal use. It consists of over 14K of efficiently written machine code. It is entirely self contained and so does not require a utilities disc to function.

- The system can either use the ACORN standard 31 files per disc side or DOUBLE THE CAPACITY to 62 files. The size is selected at formatting time. Copying between discs with different catalogue sizes works perfectly normally.

- A FORMATTING PROGRAM is built in, permitting formatting to 35, 40, 80 track formats with either 31 or 62 files. Since the formatter is built in to the DFS it can be used without affecting whatever program you are using.

- A DISC VERIFIER is also built in. This checks the internal checksums on each sector to identify any corrupted data. This is extremely useful when saving valuable data as it shows faulty discs quickly and easily. Again it does not affect the program you are using.

- A built in DISC SECTOR EDITOR gives a screen window onto the disc enabling detailed editing of any byte on the disc. This is very useful for recovering accidentally deleted files and can save weeks of work.

- A double step mode allows the User of 80 TRACK DRIVES TO READ & WRITE BOTH 40 and 80 TRACK DISCS. This mode is software selected for each drive individually, thus enabling a 40 track disc to be copied on to an 80 track very easily. THIS ELIMINATES THE NEED FOR EXPENSIVE 40/80 TRACK SWITCHABLE DRIVES.

- A WORKFILE function sets the name to be used when the null filename is issued. This allows a program to be edited and repeatedly saved having only typed its name once.

- When using LOAD, CHAIN, etc, it is possible to specify an ambiguous filename. This will result in the first file whose name matches the specification being used. This saves typing the end of a filename that you know is uniquely identified by its first few characters.

- Two commands exist to simplify the transfer of programs from TAPE TO DISC. These load the file to &1100, switch off the disc system and then move the file to its correct load address; thus saving a lot of complicated programming. This command can be used to load files up to 27K75 long.

- An advanced COPY command is included which will prompt the user, requesting whether to copy each file.

- RENAME has been extended to allow the use of ambiguous filenames. This allows you to change BERT1, BERT2, BERT3 to FRED1, FRED2, FRED3 with only one command.

- OPENOUT has been improved to give you fewer annoying 'Can't extend' errors, as it automatically picks the biggest space on the disc in which to put a file. A SPACE command lets you know how much space *COMPACT could create before you waste time doing it.

Continued:

BEEBFONT ROM

BEEBFONT is a remarkable new concept in software, exclusively available from Watford. Once fitted, the 16K ROM will enable you to produce attractive text displays in following different styles:



- ★ It works in modes 0, 1, 2, 4, using full colour.

- ★ Simply use Ctrl-V to select the font and further screen output will be in a new style.

- ★ Even the ordinary Beeb character set can be enhanced by doubling height or width and emphasising to give bold print.

- ★ A comprehensive editor is included which enables the user to design his own character sets.

- ★ A spooling program is provided, which enables pre-formatted text files to be displayed on an EPSON FX, RX, and NEC Printers, using the full range of character styles. (Please specify printer type when ordering). Can be used WORDWISE.

- ★ This really must be one of the most original and exciting products of the year.

- ★ A twenty page manual is provided and a demo/editor software comes on disc or cassette (please specify when ordering).

ONLY

DFS continued:

- 2K of RAM can be reclaimed from the DFS by setting "PAGE" to & 1100.

Now with extra features:

- The powerful library system has been extended so that libraries now work on all accesses not only *RUN. This allows you to have a utility directory with all your commonly used programs without muddling in your current workfiles. Very useful for BCPL User

- Programs can now reside lower in memory reclaiming some of the DFS' workspaces. In PAGE can be taken as low as £1100 under circumstances.

- To make DFS easy to use, wild cards (* * * have been made vastly powerful, e.g. *INFO gives information on all files in the current directory which have an 'A' anywhere at all in their filename.

- Comprehensive and clearly written Manual (available separately) gives the user a complete package deal

- Fully compatible with BBC TELETEX and TORCH Systems.

DFS ROM **ONLY**
Complete Disc Interface Kit including DFS ROM and fitting instructions. **P.**
Comprehensive and clearly written DFS Manual **£7.50 (No V**

P.S. We will exchange your existing ACORN or PACE (AMCOM) DFS for the highly sophisticated Watford's DFS ROM for **ONLY**

Watford's DFS is exclusively available from Watford Electronics. We DO NOT retail through any Dealers.

**WATFORD'S
BEEB PRINTER ROM**



"Makes Printing Childs Play"

you fed up with not being able to unravel your printer manual and use all those features you paid for? Need sensible paging for use in the creation of documents? Then you certainly need our Beeb Printer ROM.

Machine code printer utility in ROM.

Single key operations replace control code sequences for underline, font and size selection, paper movement, etc. Up to 30 come pre-defined, without effecting normal fn key usage.

This rom allows easy control of your printer from 'Within' WORDWISE text. Need of long escape sequences, you just use a single number to Select, Underline, Bold Styles, etc.

Automatic fanfold page margins. Puts gaps in pages PRINTED text etc to skip the folds. The gap alternates to minimise paper wastage when using binders.

Form feed and related commands, made available on ALL printers. Can also provide a left margin.

User defined characters embedded within text printed as on VDU.

Commands select option for GP100, STAR, EC, MX/FX, LP VII/DMP100, DMP200. Operates with Parallel and Serial Printers.

Fully functional with the popular WORDWISE wordprocessor.

Applied complete with a comprehensive 50 page manual.

Price: £24

When ordering, please specify printer type!

SPECIAL OFFER

WATFORD'S BEEB PRINTER ROM and any one of the two SCREEN DUMP ROMS for

ONLY: £33 (A saving of £7+)

TWO GRAPHICS

SCREEN DUMP ROMS

DUMP OUT '2

Versatile machine code hi-res Screen Dump ROM.

You can now have small or large 2 tone dumps and multi-tone 'colour' pattern dumps (distinct mode 2 shades) on every printer.

*Commands initiate the required dump (optional parameters may be included for colour coding and selecting the part of the screen to be dumped).

Clever use of the processor stack means (at no workspace is required) (Multitone dumps also use 2 zero page locations.)

For GP80/100/250, STAR, NEC, EPSON/RX/FX, LPVII, DMP100/120/200/400. Screen modes 0, 1, 2, 4, & 5. Instruction Manual included.

this for **ONLY £15**

EPSON DUMP ROM

Specially designed Dump ROM for EPSON RX, and the new Kaga KP810 Printers. Will accurately DUMP all Screen modes including LETEX TEXT GRAPHICS and DOUBLE HEIGHT. MULTITONE DUMPS are also supported. Simple single command (*SCDUMP) operation.

Only: £16

**WATFORD JOINS THE
COMMUNICATION REVOLUTION**

MODEM 84



Prestel

A British Telecom Service.

With the launch of Watford's MODEM 84 you can now hook into PRESTEL, MICRONET, HOMELINK, TELECOM GOLD, etc., for about the cost of a good tape recorder. Prestel gives you access to an incomparable database covering almost every subject under the Sun. There is Micronet with lots of free programs that you can download and run. Details of Clubs and User groups, a diary of meetings and exhibitions, news and reviews, technical information, etc. There is Homelink with On-line banking. And there is armchair shopping, travel information, Entertainment, World News, Sports News, Business News, Weather information, Electronic mail and lots more. The basic Prestel subscription is only £5 per quarter for domestic user and at off-peak times there is no charge for access time. Can you afford not to be part of this revolution?

Now using the latest techniques and the new generation of Modem chips, Watford have developed a Modem that is newer, better and yet cheaper than any on the market.

Compare the Specifications:

MODEM

- Direct-connect Modem using BT approved isolation components.
- Full Duplex V23 operation for Prestel and TELECOM GOLD operation (1200/75 Baud).
- User-to-User half duplex 1200/1200 Baud operation with AUTOMATIC SEND/RECEIVE switch (BEWARE - most MODEMS switch manually between send and receive, which precludes the use of intelligent user-to-user software)
- Simple single button operation and comprehensive LED status display.
- Attractive Beige case to match your Micro Sized to sit on the disc drive.

(P.S. BT approval applied for).

NEW FX80 PRINTER DRIVER for VIEW

Do you want to use Italics or Enlarged Characters with View? French or German Characters? These and other FONTS from FX80 character sets can be accessed using our Printer Driver with VIEW. The disc contains an example as well shows how to use. Available on 40 or 80 track Disc. **ONLY: £7.50**



**NEW SUPER PRESTEL
INTERFACE ROM**

Fully compatible with Watford's MODEM 84 as well as with PRISM and most other Modems.

- Supports full Prestel Colour Alpha and Graphic Characters including Double Height, Flashing, Conceal/Reveal.
- Called by simple *PRESTEL command. Disc and Tape configurations fully supported.
- Telesoftware downloader included.
- Comprehensive MAILBOX facilities including offline editor.
- Auto Logon sequence, can be burnt into ROM if desired.
- Unique "TAG" facility allows tagging and recall of interesting pages - avoids the common and annoying 'NOW WHERE WAS THAT PAGE' problem.
- Page load and save to tape or disc. Pages are automatically saved under Page Number reference in a 'FRAME' directory.
- Print page options are ASCII only (i.e. with suppression of Graphics) - fast and works with any printer - as well as a full graphics dump for the popular Epson printer.
- 'USER' function call built into interface with specialist add-on routines (your own as well as ours).
- All the above facilities available from Function Keys. An overlay is provided giving simple yet comprehensive guidance to the key functions.
- Comprehensive instruction manual supplied.

PRICES:

SOFTWARE in ROM incl. Comprehensive MANUAL ONLY: £25

MODEM 84, SOFTWARE in ROM & Operating MANUAL ONLY: £75 (carr. £1.50)

(Please allow upto 28 days for delivery)

Coming soon:

BEEB User-to-User ROM. For automatic user-to-user communication including file/program transfer. (Requires Watford's MODEM B4 or

PRISM 2000).

Please write to Watford Electronics for full details, Order and Application Forms.

VIEW

Acorn soft's Wordprocessor ROM **£52**

FORTH ROM for BBC

This superb (FIG FORTH) compiling language now available in ROM. Simply plugs into one of the ROM Sockets. Manual included. **£33**

**WATFORD
ELECTRONICS**

Continued

WONDERFUL WATFORD

TWO NEW DATABASE SOFTWARE for BBC Micro

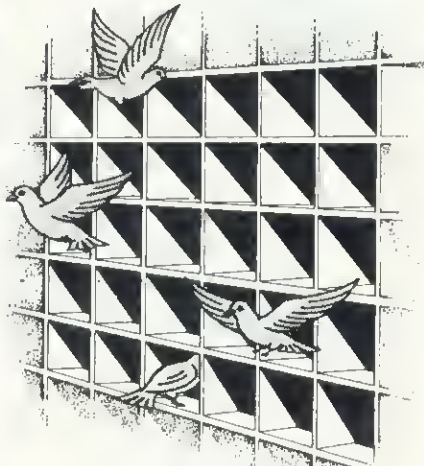

DISCDATA

At last for BBC Micro Disc users, Watford Electronics have produced 'DISCDATA' which must be the most versatile general database at the price on the market. The length of your files is restricted only by the space on your disc. You can have upto 2D fields with 'page' length records of upto 254 characters. The program is completely menu driven obviating reference to a manual although written guidance is given with the program. Add and delete records, amend title, field names and records, sort on any field and search for any record or group of records in any field. You do not need to abandon or rewrite your files if you wish to add additional fields or extend the length of any field, the program will rewrite the files for you. Your files can be in any drive. Output can be in 4D, BD or 132 character width with Printer routines. Two forms of output are provided for horizontal for label type output and a tabulated output with title and headings. What is more, the selected fields can be placed in any order on the screen. In the horizontal mode you can scan backwards or forwards with wrap around effect. Output can be started or stopped anywhere in the file. There is automatic totalling on decimal fields and an automatic count of the number of records output. Now with extra 3 features: Allows string search; Calculations can be done on numeric fields; Create Sub-Files from the main File.

On disc at **Only £15**
It has to be the best value.

FILE-PLUS

A 16K ROM containing the most flexible and easy to use disk based Database system on the market. A database may occupy your total on-line storage capacity. You may design any number of data entry forms using a "paint" on screen technique. Forms may be upto 3 screens in size. A form may be used to Add, Delete, Update, Print and Spool records from your Database. Quick search facility on any text field. A query language provides full maths support (=, +, /, *, +-9999999999.9999) and compare facilities (=, >, <), (<=, >=, &, !), when used with the keywords - Assign, Compare, Display, End, Goto, If, Ift, Print, Read, Search, Spool and Update. Full printed output control via embedded commands. Supplied with 70 page manual and fitting instructions.

Only £43

Send SAE for Fact Sheet

★ STAR LAUNCH ★ BUFFER & BACKUP ROM

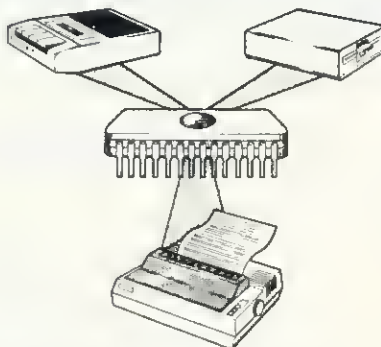

A very versatile firmware. An ideal ROM for engineers, programmers, teachers, students, etc.

★ Converts your Sideways RAM to a 4K or 16K BUFFER for a parallel printer. (Uses * FX5,3). (You no longer require to purchase expensive (£100+) Printer Buffers.)

★ Dumps selection of Disc files to Tape.

★ Makes backup copies of tapes onto Tape, Disc and Hobbit.

★ Displays contents of a chosen paged ROM on screen.

★ Menu display on 'shift-break' using ROM Filing System.

★ Comprehensive Manual
Simply a give away at

£18

In keeping with our tradition of bringing you the best in BBC Micro at prices you cannot refuse, we are launching yet another of our ROM based software.

**NEW
LAUNCH**

TERMEMU

(A Terminal Emulator ROM for BBC Micro)

Use your BBC micro as a VDU terminal, connected to any other computer with a V24 or RS423/RS232 serial interface. Transfer text files in either direction, using disc or tape filing system.

Powerful function set allows emulation of popular mainframe terminals, including full DEC VT52. A tailoring program is included which allows you to define your own terminal and save the file on disc or tape.

The TERMEMU ROM is entered either using *VDU, or directly when the BBC micro is switched on.

Features include:

- Compatible with BT GOLD electronic mail service
- Full BBC graphics available
- Split baud rate for receive/transmit
- User-defined function keys
- Visible control codes (for debugging protocols)
- Full cursor addressing
- User-definable addressing convention
- ALL OS commands available, even when online
- SPOOL and EXEC, even at 75 baud
- Parity, start/stop and number of bits
- Change baud rates online
- Online/local operation
- Runs in any mode
- Comprehensive manual and fitting instructions

ALL THIS and MORE FOR ONLY **£24**
(Price includes tailoring software on disc or cassette and manual)

Suitable cable for RS423 domino to V24

ONLY £5

PACKAGE OFFER

BBC model B, ZENITH 12" monitor, plus TERMEMU and cables, a complete mainframe terminal for:

ONLY £445

ACCESS HOT LINE

(0923) 50234

24 hours

GEMINI'S BUSINESS SOFTWARE

Cashbook Accounts	£ 1
Final Accounts	£ 1
Invoices & Statements	£ 1
Commercial Accounts	£ 1
Mailing List	£ 1
Database	£ 1
Stock Control	£ 1
Home Accounts	£ 1
Beebcalc Spreadsheet Analysis	£ 1
Beebplot	£ 1
Payroll	

N.B. All the above Gemini software is on Disc. For Disc Based (4D/BD track) please add

VERSATILE LIGHT PEN SOFTWARE

- Enjoy, Explore, Educate!
- Pixil, Line, Character Definition
- Free hand drawing
- All Colours - MANY Special Effects
- Fill, Refill and Stripes
- User defined "Brushed Strokes" plus Character definer
- Grid, Scale, Perspective aids
- 2 TO 2D0 Points palletable in one Design with Circles and "RUBBER BANDING"
- Move design/character to any screen position
- Save and Load screens, User defined Graphics and line drawings for video titles, Own programmes, etc.
- Many Educational uses
- Instruction booklet included
- Full software support for "CUSTOM USE"
- Works with Watford, RH, Acorn User Disc and many other LIGHT PENS
- Available on DISC or TAPE

Price: Tape **£10**; Disc **£11**

DISC EXECUTOR

Disc Executor is a sophisticated disc utility, designed for the BBC Micro, which allows you to transfer almost all of your tape software to disc. It will handle 'Locked' programs and allows you to load full length adventure type programs (i.e. up to 86E blocks) from disc in seconds rather than minutes. Available in 40B0 track, please specify.

Price: **£1**

Now available from Watford

ADE

The complete program development package on 16K ROM. A must for all the Assembly Language Programmers.

Introductory price: **Only: £52**

GAMES SOFTWARE (PROGRAM POWER)

CHESS	£6.
CROACKER	£6.
Escape from MOONBASE ALPHA	£6.
CHUCKIE EGG	£7.
FELIX in the FACTORY	£6.
GALACTIC COMMANDER	£6.
KILLER GORILLA	£6.
MUNCHYMAN	£5.
MOONRAIDER	£6.
PENGO (Watford)	£7.
SWOOP	£6.
747 FLIGHT SIMULATOR	£7.

LEVEL 9 ADVENTURE GAMES

COLOSSAL ADVENTURE. The classical mainframe game "Adventure" with all the original puzzles plus 70 extra rooms.

£8

ADVENTURE QUEST. Through forest, mountains, desert, caves, water, fire, moorland and swamp on an epic quest vs tyranny.

£8

DUNGEON ADVENTURE. Over 100 puzzles the Oemon Lord's dungeons.

£8

SNOWBALL. Save a 7DDD location colony starship in 2302 AD.

£8

**WATFORD'S
BEEB PRINTER ROM**



Are you fed up with not being able to unravel your printer manual and use all those features you paid for? Need sensible paging for use in the creation of booklets? Then you certainly need our Beeb Printer ROM.

Machine code printer utility in ROM.

'Single' key operations replace control code sequences for underline, font and size selection, paper movement, etc. Up to 30 come pre-defined, without effecting normal fn key usage.

This rom allows easy control of your printer from 'Within' WORDWISE text. Instead of long escape sequences, you just hit a single number to Select, Underline, Print Styles, etc.

Automatic fanfold page margins. Puts gaps in strings. PRINTed text etc to skip the folds. The gap size alternates to minimise paper wastage when using binders.

Form feed and related commands, made available on ALL printers. Can also provide a left margin.

User defined characters embedded within text are printed as on VDU.

★ Commands select option for GP100, STAR, NEC, MX/FX, LP VII/OMP100, OMP200. Operates with Parallel and Serial Printers.

Fully functional with the popular WOROWISE wordprocessor.

Supplied complete with a comprehensive 50 page manual.

Price: £24

(When ordering, please specify printer type)

SPECIAL OFFER

Buy BEEB PRINTER ROM and any one of the two SCREEN DUMP ROMS for

ONLY: £33 (A saving of £7+)

TWO GRAPHICS

SCREEN DUMP ROMS

DUMP OUT 2

A versatile machine code hi-res Screen Dump ROM.

● You can now have small or large 2 tone dumps and multi-tone 'colour' pattern dumps. (2 distinct mode 2 shades) on every printer.

● Commands initiate the required dump optional parameters may be included for colour masking and selecting the part of the screen to be dumped.

● Clever use of the processor stack means that no workspace is required! (Multitone dumps also use 2 zero page locations.)

● For GP80/100/250, STAR, NEC, EPSON MX/RX/FX, LPVII, OMP100/120/200/400.

● Screen modes 0, 1, 2, 4, & 5.

● Instruction Manual

All this for

ONLY £15

EPSON DUMP ROM

A specially designed Dump ROM for EPSON RX, X and the new Kaga KP810 Printers. Will accurately OUMP all Screen modes including TELETEXT, GRAPHICS and DOUBLE HEIGHT. MULTITONE DUMPS are also supported. Simple single command (*SCDUMP) operation.

Only: £16

**WATFORD JOINS THE
COMMUNICATION REVOLUTION**

MODEM 84

Prestel

A British Telecom Service.



With the launch of Watford's MODEM 84 you can now hook into PRESTEL, MICRONET, HOMELINK, TELECOM GOLD, etc., for about the cost of a good tape recorder. Prestel gives you access to an incomparable database covering almost every subject under the Sun. There is Micronet with lots of free programs that you can download and run. Details of Clubs and User groups, a diary of meetings and exhibitions, news and reviews, technical information, etc. There is Homelink with On-line banking. And there is armchair shopping, travel information, Entertainment, World News, Sports News, Business News, Weather information, Electronic mail and lots more. The basic Prestel subscription is only £5 per quarter for domestic user and at off-peak times there is no charge for access time. Can you afford not to be part of this revolution?

Now using the latest techniques and the new generation of Modem chips, Watford have developed a Modem that is newer, better and yet cheaper than any on the market.

Compare the Specifications:

MODEM

- Direct-connect Modem using BT approved isolation components.
- Full Duplex V23 operation for Prestel and TELECOM GOLD operation (1200/75 Baud).
- User-to-User half duplex 1200/1200 Baud operation with AUTOMATIC SEND/RECEIVE switch (BEWARE - most MODEMS switch manually between send and receive, which precludes the use of intelligent user-to-user software).
- Simple single button operation and comprehensive LED status display.
- Attractive Beige case to match your Micro. Sized to sit on the disc drive.

(P.S. BT approval applied for).

**NEW SUPER PRESTEL
INTERFACE ROM**

Fully compatible with Watford's MODEM B4 as well as with PRISM and most other Modems.

- Supports full Prestel Colour Alpha and Graphic Characters including Double Height, Flashing, Conceal/Reveal.
- Called by simple *PRESTEL command. Disc and Tape configurations fully supported.
- Telesoftware downloader included.
- Comprehensive MAILBOX facilities including offline editor.
- Auto Logon sequence, can be burnt into ROM if desired.
- Unique "TAG" facility allows tagging and recall of interesting pages - avoids the common and annoying 'NOW WHERE WAS THAT PAGE' problem.
- Page load and save to tape or disc. Pages are automatically saved under Page Number reference in a 'FRAME' directory.
- Print page options are ASCII only (i.e. with suppression of Graphics) - fast and works with any printer - as well as a full graphics dump for the popular Epson printer.
- 'USER' function call built into interface with specialist add-on routines (your own as well as ours).
- All the above facilities available from Function Keys. An overlay is provided giving simple yet comprehensive guidance to the key functions.
- Comprehensive instruction manual supplied.

PRICES:

SOFTWARE in ROM incl. Comprehensive MANUAL ONLY: £25

MODEM B4, SOFTWARE in ROM & Operating MANUAL ONLY: £75 (carr. £1.50)

(Please allow upto 28 days for delivery)

Coming soon:
BEEB User-to-User ROM. For automatic user-to-user communication including file/program transfer. (Requires Watford's MODEM B4 or PRISM 2000).
Please write to Watford Electronics for full details, Order and Application Forms.

**NEW FX80 PRINTER
DRIVER for VIEW**

Do you want to use Italics or Enlarged Characters with View? French or German Characters? These and other FONTS from FX80 character sets can be accessed using our Printer Driver with VIEW. The disc contains an example as well shows how to use. Available on 40 or 80 track Disc. **ONLY: £7.50**

VIEW

Acorn soft's Wordprocessor ROM. **£52**

FORTH ROM for BBC

This superb (FIG FORTH) compiling language now available in ROM. Simply plugs into one of the ROM Sockets. Manual included. **£33**



**WATFORD
ELECTRONICS**

Continued

BOOKS (No VAT on Books)

30 Programs - BBC Micro	£3.25
30 Hour BASIC (BBC Micro)	£6.95
35 Education Programs for BBC	£6.95
36 Challenging Games for BBC	£5.95
40 Educational Programs for BBC	£5.95
100 Programs for BBC Micro	£6.95
Cassette version of above	£10.00
6502 Application Book	£11.95
6502 Assembly Language Program ..	£13.95
6502 Assembly Language Subroutines	£14.25
6502 Machine Code for Beginners	£5.95
6502 Software Design	£10.50
A young persons guide to BBC Basic ...	£4.50
Advanced Machine Code Technique for BBC	£7.95
Advanced User Guide for BBC Micro	£12.50
Advanced 6502 Interfacing	£10.95
Advanced 6502 Programming	£12.45
Assembly Language Programming on BBC Micro	£7.95
Advanced Programming Techniques for the BBC Micro	£7.95
BBC Basic	£7.95
Assembly Lang. Prog. on BBC	£7.40
BBC BASIC	£5.95
BBC Basic for Beginners	£6.95
BBC Forth	£7.50
BBC Lisp	£7.50
BBC Micro An Expert Guide	£6.95
BBC Micro Book BASIC Sound & Graphics	£7.95
BBC Micro Graphics and Sound	£6.95
BBC Micro Programs in Basic	£5.95
BBC Micro ROM PAGING System Explained	£2.95
BBC Micro Revealed	£6.95
BBC Micro Assembly Lang. Prog.	£7.95
BBC Micro Disc Companion	£7.95
BBC Micro in Education	£6.50
Basic Programming on BBC Micro	£5.95
Creating Adventure Programs on BBC Micros	£6.95
Creative Graphics Cassette (Acornsoft). Has 36 graphics programs	£8.95
Creative graphics on BBC Micro	£7.50
Complete Programmer for BBC	£5.95
DISC FILING SYSTEM Manual for BBC (comprehensive)	£7.50
Discover BBC Machine Code	£6.95
Discover FORTH	£13.95
DIY Robotics & Sensors with BBC	£6.95
Easy Programming for BBC Micro	£5.95
Further Prog. for BBC Micro	£5.95
FORTH Programming	£14.40
Functional Forth for the BBC Micro	£5.95
Games on your BBC Micro	£2.95
Games BBC Computer Can Play	£6.95
Graphs & Charts on BBC Micro	£7.50
Graphic Art for BBC Computer	£5.95
Graphs and Charts (Cassette)	£7.50
Graphics on BBC Micro	£6.95
Hobbit (Book and Cassette)	£14.95
Introducing the BBC Micro	£5.95
Introduction to FORTH	£9.30
Intro to Micro Beginners Book (3 Ed.)	£9.90
Let your BBC teach u to program	£6.45
LISP	£9.25
Logo Programming	£8.95
Mastering VISICALC	£12.45
Mastering CP/M	£13.65
Micros in the Classroom	£4.90
Programming the 6502	£11.95
Programming & Interfacing 6502	£16.00
Programming the BBC Micro	£6.95
PASCAL	£9.25
Programming for Education on BBC ...	£5.95
Structured Prog. with BBC BASIC	£6.50
The Complete FORTH	£6.95
The BBC Micro Book, BASIC, SOUND & GRAPHICS	£7.40
Using Floppy Discs with BBC Micro	£5.95
Using BBC Basic	£6.95

ONLY THE BEST AT
WATFORD

STOP PRESS

DOUBLE DENSITY BOARD FOR BBC

We are proud to announce the launch of our Double Density Board for the BBC Micro. The DDFS software that we supply is a version of our highly acclaimed standard 16K DFS for the BBC Micro. It will automatically tell whether a single or double density disc is being accessed, as well as allowing the option of reading 40 track disc on an 80 track drive. Now on your B0 track Double Sided Drive you will have 720K storage instead of the usual 400K and with higher speed than ever before (of course this is a BONUS at NO EXTRA COST). Complete Double Density Upgrade Unit will cost same as single density Kit.

DATA RECORDER & ACCESSORIES

Top quality Slimline, portable Data Recorder for computer use. Mains/Battery, operated with counter

DATA RECORDER CABLE £24.00

For our Data Recorder to BBC Micro £2.50

DATA CASSETTES Top grade C12 Data Cassettes in library cases. 36p

ATTACHE CARRYING CASE for BBC Micro

These Attache Carrying cases are attractively finished in mottled antique brown leatherette. An ideal and very safe way to carry your BBC Microcomputer. Price: £12 (£2 carr.)

ADVANCE USER GUIDE for BBC MICRO

Only: £12.50 (no VAT)

VOLTMACE'S DELTA 14 Hand-set

Price: 'Delta 14' Hand set £12.50
ADAPTOR MODULE £12.55
TRANSFER PROGRAM Tape £5.10
Disc £7.95

JOYSTICKS for BEEB

Two versions available:

SINGLE: Player type £7.00 each
TWO Players type £12.00 per pair

Prices subject to change without notice.

MAIL ORDER AND RETAIL SHOP. TRADE AND EXPORT INQUIRIES WELCOME. GOVERNMENT AND EDUCATIONAL ESTABLISHMENTS OFFICIAL ORDERS ACCEPTED. CARRIAGE: Unless stated otherwise, please add 75p to all cash orders.

VAT: UK customers please add 15% VAT to the total cost incl. Carriage.

SHOP HOURS: 9.00am to 6.00pm. Monday to Saturday. (Ample Free Car Parking Spaces)

ACCESS ORDERS: Simply phone: Watford (0923) 50234. (24 Hours)

PLINTH FOR PRINTERS

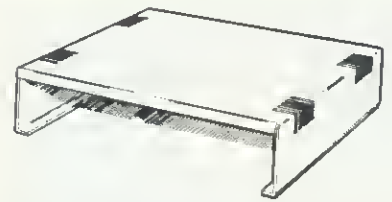

Keeps your desk tidy. Place the printer on the plinth and the paper underneath. Finished in BBC colour

£10 (carr. £1.50)

PLINTH FOR BBC MICRO

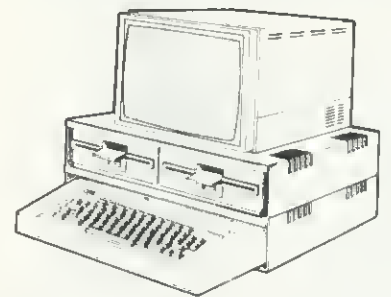

Protect your micro from the weight of the heavy TV/Monitor. This sturdy plinth is attractively finished in BBC colour. Air vent slots have been provided to allow maximum air circulation. It can be used to support a monitor or a printer. The micro slides underneath comfortably. A must for every BBC Micro owner, specially for those who have to move/open their computer frequently.

Single Decker £11 (carr. £1.50)
Double Decker £20 (carr. £2.00)

4 WAY MAINS DISTRIBUTION SOCKET

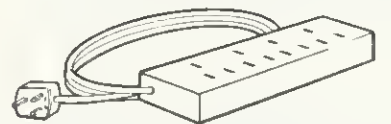

A highly versatile space saving solution when multi-power outlets are required. Can be wall or floor mounted. Ideal for Micro Computer and peripherals application. Prevents you getting a dangerous tangle of plugs and adapters.

Only: £9.50

TEX EPROM ERASERS

EPROMs need careful treatment to survive their expected lifetime. Rushing it could burn their brains out. So cop-out of this helter-skelter world; take it easy the TEX way and give your chips a well earned break. Cool, gentle and affordable. EPROMPT does it properly.

Two versions available:

● EPROMPT EB - The standard version. Erases up to 16 chips. £30.00

● EPROMPT GT - Erases up to 2B chips. Has an incorporated safety switch which automatically switches off the UV lamp when the Eraser is opened. £33.00

Watford Electronics

Dept. BBC, Cardiff Road, Watford, Herts, England.
Telephone: 0923 40588/37774. Telex: 8956095

BALANCING ACT

Stan Froco returns to the theme of binary trees*. Their balanced structure makes 'B-trees' valuable for databases stored on disc

* See August 1983 issue

FIRST a quick reminder of what a 'tree' is. Figure 1 shows a simple binary tree of numbers. At the top is the 'root' of the tree. The tree comprises 'nodes', each holding a value and two 'pointers'. At the bottom of the tree are its 'leaves', which are like nodes, but have no pointers. In the example the root is labelled A, the nodes B and the leaves C. Notice that the root is just another node.

The pointers are the arrows joining the parts of the tree. We say a node has two pointers to its 'children' (which may be other nodes, or leaves), and correspondingly the children have the node as their 'parent'. The root is unique in that it has no parent.

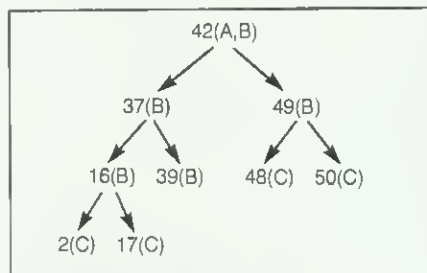

Figure 1. A simple binary tree

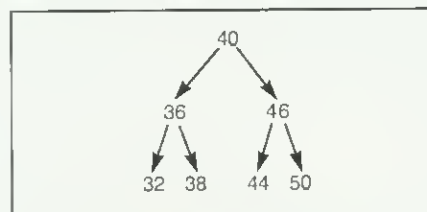

Figure 2. A tailor's database

Trees are useful for looking up information and as such form the heart of many database systems. The pieces of information held in the nodes and leaves of the tree are referred to as 'keys'. We talk of looking up a key in a database. Figure 2 shows an example application, a database of jacket sizes stocked by a tailor. If he has a jacket of the correct size it appears in the tree. The method or algorithm for looking up an item in the tree is fairly straightforward:

1. Take the root as the first node to examine.
2. If the item matches the key for this node STOP - we have found the item in the database.
3. If the node has no pointers, ie, it is a leaf STOP - the item is not in the database.
4. If the item is less than the key for this node, take the node or leaf pointed to by the left pointer, ELSE take the node or leaf pointed to by the right pointer.
5. GOTO 2

In other words we walk down the tree looking for the relevant key. Typically, we would store additional information with the key - for instance, the number of jackets in stock in this example. The key is crucial, however, since it is the thing we are comparing against.

For database applications a simple binary tree is not flexible enough. You will see that while looking up an item the number of steps taken is up to the number of steps taken to get to a leaf from the root. In Figure 1 you will see that the distance from root to leaf varies depending on the leaf. Figure 2 is, on the other hand, a 'balanced binary tree'. Every leaf is the same distance from the root (this distance is called the depth of the tree, in this case three). If a tree is balanced we know the worst-case performance (ie, the number of steps it takes to find a particular key) is as small as possible.

This is not that important when the tree is small and in memory, since following a pointer to another place in memory is not that slow an operation. However, for a large database the tree will be held on disc or some other backing medium. Following a pointer now means getting another block from disc, and is very slow. For this reason we want trees as near balanced as possible to minimise disc access. Binary trees are tricky to balance, and so we need to look at some more sophisticated types of tree.

One way of extending binary trees is to have more than two children for each

node (possibly a variable number). This means that it spreads out faster and for a given number of nodes is not so deep, requiring fewer steps to look up a key. 'B-trees' are a popular example of such trees. A 'B-tree of order m' has five properties:-

1. Every node has m or fewer children.
2. Every node that is not a leaf or the root has m/2 children or more.
3. The root has at least 2 children (unless it is a leaf).
4. All leaves are at the same depth and contain no information.
5. A non-leaf node with k children has k-1 keys.

Figure 3 shows a B-tree of order 5. The general form of each node is

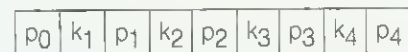

We can see that each key is less than any key in the tree pointed to by the corresponding pointer, ie:

- k₄ <= any key pointed to by p₄
- k₃ <= any key pointed to by p₃
- k₂ <= any key pointed to by p₂
- k₁ <= any key pointed to by p₁

Finally p₀ points to all the keys less than k₁.

To be of any use in a database we need to provide the three operations

1. Look up a key in the database.
2. Insert a key in the database.
3. Delete a key from the database.

Program 1 uses a B-tree of order 7 and provides lookup (PROCretrieve) and insertion (PROCaddtotree). For conciseness I have left out deletion, since this is essentially the technique for insertion in reverse. Given one, you should be able to deduce how to do the other. page 49 ►

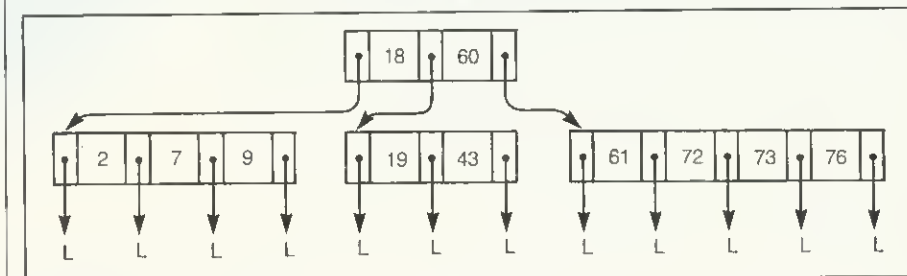

Figure 3. A B-tree of order 5

Take Advantage of us!

50 s/s d/d disks + box – £50 plus VAT + p&p

50 d/s d/d disks + box – £75 plus VAT + p&p

Discotek sells disks and accessories, we'll sell them to practically anyone, anywhere. So when we got a telephone order for a lot of storage boxes and disks we didn't waste any time and stocked up. Then the order was cancelled. So we're having to let them go at cost, in fact, less than cost.

For just £50 we can supply a rigid, high impact plastic storage box, with four dividers packed with 50 single-sided, double-density disks. The same storage box filled with 50 double-sided, double density disks will cost just £75. And all carrying our five year guarantee – if a disk is faulty send it back for two free replacements.

To order just clip the coupon below.



To Disco-Technology Ltd,
20 Orange Street,
London WC2H 7ED 01-930 1612 (24 hours)

Please rush me _____ qty storage boxes filled with 50 single-sided

50 double-sided disks at £59.50 or £87.25 respectively.

(£2 already added for p&p and insurance) I enclose a cheque for £ _____

or debit my Access card No. _____

Name _____ Signature _____

Address _____

Postcode _____ Telephone _____

To Disco-Technology Ltd,
20 Orange Street,
London WC2H 7ED

DISCO-TEK
COMPUTER PRODUCTS

Program 1. Demonstration of B-frees, using a B-tree of order 7

```

10 REM*****
20 REM
30 REM   Demonstrate operations on B-trees
40 REM
50 REM*****
60
70 MODE 7
80
90 REM Useful values
100
110 linstore% = 1000
120 infinity% = 1000000
130 leaf% = -1 :REM pointer to a leaf
140 nextfree% = 0 :REM where to start dishing out store from
150
160 REM Set up some arrays
170
180 DIM tree%(linstore%)
190 DIM temp%(14) :REM workspace
200 root% = FNgetnode :REM the root of the tree
210
220 PRINT "Enter some sample data, ending with 0"
230
240 REPEAT
250   INPUT ":" data%
260   IF data% = 0 THEN UNTIL TRUE : GOTO 310
270   PROCaddtotree(data%)
280   UNTIL FALSE
290
300 REM Try retrieving
310 PRINT "Try some lookups"
320
330 REPEAT
340   INPUT ":" data%
350   PROCretrieve(data%,root%)
360   UNTIL FALSE
370 END
380
390 REM**** Return a new node for the tree
400
410 DEF FNgetnode
420   LOCAL t%
430
440   t% = nextfree%
450   nextfree% = nextfree% + 13
460
470   IF nextfree% > linstore% THEN PRINT "Store used up" : STOP
480
490   FOR i% = 1 TO 11 STEP 2
500     tree%(t% + i%) = infinity%
510     tree%(t% + i% + 1) = leaf%
520   NEXT i%
530
540   tree%(t%) = leaf%
550
560   =t% :REM the new node
570
580 REM**** Add a new data element
590
600 DEF PROCaddtotree(key%)
610   LOCAL newroot%
620
630   IF FNinsert(key%,root%) THEN ENDPROC :REM successful insertion
640
650   REM Create new root
660
670   newroot% = FNgetnode
680   tree%(newroot%) = root%
690   tree%(newroot% + 1) = reskey%
700   tree%(newroot% + 2) = resptr%
710   root% = newroot%
720
730   ENDPROC
740
750 REM**** Insert new element in a subtree - TRUE => inserted
760
770 DEF FNinsert(key%,node%)
780   IF tree%(node%) = leaf% THEN =FNinsert(key%,leaf%,node%)
       :REM at bottom
790   IF FNinsert(key%,tree%(node%+FNfindplace(key%,node%)))
       THEN =TRUE
800
810   REM Must have to split
820
830   =FNinsert(reskey%,resptr%,node%)
840
850 REM**** Find where to insert in node
860
870 DEF FNfindplace(key%,node%)
880   LOCAL i%
890
900   IF key% < tree%(node% + 1) THEN =0 :REM at beginning
910
920   i% = 11 :REM linear search through (from highest)
930
940   IF key% >= tree%(node% + i%) THEN =i% + 1
950   i% = i% - 2
960   GOTO 940
970
980 REM**** Insert a key
990
1000 DEF FNdoinsert(key%,keyptr%,node%)
1010   IF tree%(node% + 1) = infinity% THEN PROCinsertit(key%,keyptr%,node%) : =TRUE

```

```

1020
1030   REM No room in current node so split
1040
1050   PROCsplittree(key%,keyptr%,node%) : =FALSE
1060
1070 REM**** Insert in current node
1080
1090 DEF PROCinsertit(key%,keyptr%,node%)
1100   LOCAL i%
1110
1120   i% = 12
1130
1140   REPEAT
1150   IF key% >= tree%(node% + i% - 3) THEN tree%(node% + i% - 1) =
       key% : tree%(node% + i%) = keyptr% : UNTIL TRUE : ENDPROC
1160
1170   tree%(node% + i% - 1) = tree%(node% + i% - 3) :REM copy down
1180   tree%(node% + i%) = tree%(node% + i% - 2)
1190   i% = i% - 2
1200   UNTIL i% < 4
1210
1220   tree%(node% + 1) = key% :REM insert at the end
1230   tree%(node% + 2) = keyptr%
1240
1250   ENDPROC
1260
1270 REM**** Split the tree
1280
1290 DEF PROCsplittree(key%,keyptr%,node%)
1300   LOCAL i%
1310
1320   REM Copy to temporary node
1330
1340   FOR i% = 0 TO 12
1350     temp%(i%) = tree%(node% + i%)
1360   NEXT i%
1370
1380   REM insert key
1390
1400   i% = 14
1410
1420   REPEAT
1430   IF key% >= temp%(i% - 3) THEN temp%(i% - 1) = key% :
       temp%(i%) = keyptr% : UNTIL TRUE : GOTO 1530
1440
1450   temp%(i% - 1) = temp%(i% - 3)
1460   temp%(i%) = temp%(i% - 2)
1470   i% = i% - 2
1480
1490   UNTIL i% < 4
1500
1510   REM Now split it
1520
1530   resptr% = FNgetnode :REM the new tree
1540   reskey% = temp%(?) :REM the data to pass back
1550
1560   FOR i% = 0 TO 6
1570     tree%(resptr% + i%) = temp%(i% + 8)
1580     tree%(node% + i%) = temp%(i%)
1590   NEXT i%
1600
1610   FOR i% = 7 TO 11 STEP 2 :REM Clear the unused bit
1620     tree%(node% + i%) = infinity%
1630     tree%(node% + i% + 1) = leaf%
1640   NEXT i%
1650
1660   ENDPROC
1670
1680 REM**** The retrieval routine
1690
1700 DEF PROCretrieve(key%,node%)
1710   IF node% = leaf% THEN PRINT "Key not found" : ENDPROC
1720
1730   place% = FNfindplace(key%,node%) :REM find where the
       key is
1740   IF place% = 0 THEN GOTO 1770 :REM avoid trouble
1750   IF tree%(node% + place% - 1) = key% THEN
       PRINT "Key found" : ENDPROC
1760
1770   PROCretrieve(key%,tree%(node% + place%)) :REM recurse
       down
1780
1790   ENDPROC

```

I represent nodes as 13 element subdivisions of a large array tree%. Thus we have nodes consisting of elements 0-12, 13-25, 26-38 and so on. Every time I need a new node I use FNgetnode to tell which element in tree% to start with. Pointers to nodes are represented as the element of tree% with which that node starts. Thus a pointer to the node starting at element 26 is represented by the value 26.

Within each node we have alternating pointers and keys. For the node starting with element 13 of tree%, p₀ would be tree% (13), k₁ would be tree% (14), p₁ would be tree% (15) and so on up to p₆ at

More than fun and games!

FIRST STEPS with the Mr. Men

by PrImer Educational Software

The ever-popular Mr. Men help prepare young children for reading with four simple and absorbing games designed to exercise essential skills as well as entertain.

An easy-to-use, colour-coded key guide is included with an illustrated introductory book, featuring the Mr. Men. For ages 4 to 8 years. Available now on cassette for the BBC B and Electron (also on the Spectrum 48K). **£8.95**

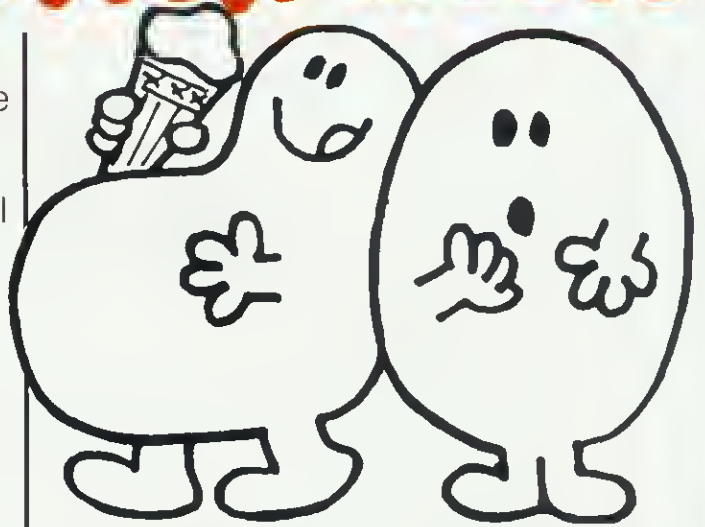

QUICK THINKING!

by Widgeit Software

Two mind-stretching, space-age games to test mental arithmetic and nimble fingers. In **Sum Vaders** alien robots invade the earth. Only quick thinking and fast reactions can prevent them. Several levels of difficulty and a two-player game with a handicap option make Sum Vaders equally testing for all family members, from 8 years to adult.

Robot Tables challenges the young player to make a series of perfect robots.

Knowing your multiplication tables is the key to controlling the robot-making machine. With a learning mode and a testing mode, Robot Tables is a fun way for early learners, and more advanced children, to master an important and often neglected skill.

Available now on cassette for the BBC B and Electron (also on the Spectrum 48K and Commodore 64). **£6.95**

CAESAR THE CAT

by Andromeda Software

Meet Caesar, a cheeky young cat on duty in a well-stocked larder. He's kept busy chasing a gang of hungry mice eating the family's food. Playing against the clock, you guide Caesar along crowded shelves to pounce on the mice.

A colourful, all-action game which is challenging for high-scoring arcade addicts as well as great fun to play for the youngster. Available now on cassette for the CBM 64, the Spectrum 48K and coming soon on the BBC B. **£8.95**

Prices include VAT and post and packaging. MIRRORSOFT programs are available from selected branches of W.H. Smith and Boots, and other leading software stockists. Trade enquiries welcome, phone 01-822 3580.

MIRRORSOFT

SOFTWARE FOR ALL THE FAMILY

To MIRRORSOFT, PO Box 50, Bromley, Kent BR2 9TT

Please send me the following (enter number required of each item in the space provided):

	Price	Spectrum 48K (01)	BBC B (03)	Electron (04)	CBM 64 (05)
First Steps with the Mr. Men (MM01)	£8.95				
Quick Thinking (QT01)	£6.95				

I enclose a cheque/PO for £..... made payable to "Readers' Account: Mirror Group Newspapers Ltd".

Or please debit my ACCESS/BARCLAYCARD for the sum of £.....

card no.

AU3

Signature

Name

Address

Postcode

I understand that my remittance will be held on my behalf in the bank account named above until the goods are despatched.

Offer applies to Great Britain and Eire only. Please allow up to 28 days for delivery in the UK. MIRRORSOFT is a registered trade mark of Mirror Group Newspapers Ltd., Co. Reg. No. 168660. Reg. Office: Holborn Circus, London EC1.

FORTH

DIMENSION

Paul Garfield
talks the lingo

FORTH is a language developed in the early 1970s as a control language for machines. It is a compiled language and therefore it is fast, its speed being close to that of machine code, although its vocabulary can be quickly learned. It deals in integer maths only, and does not handle strings as Basic does, but where commands do not exist it is possible to create new command words with your own definitions—something that is not possible in other languages.

Its interactive compiler allows very fast development work on complex projects (examples of which are given later). Its only drawback is perhaps its use of Reverse Polish Notation (RPN) in arithmetical representation and a 'stack' system for mathematical work. The programmer has to put the maths into RPN before the computer can work on it, so that computer processing time is not wasted in calculations.

The conventional infix notation yields an expression of the following type:

$$3 + 4 =$$

In Forth this would be dealt with as follows:

$$34 +$$

which would be processed as follows:

Place 3 on the computer's arithmetic stack, place 4 on top of that (it is best to think of the stack as a pile of plates that you can add to), perform an ADD operation and place the result back on the top of the stack. The 3 and 4 will have gone, and a 7 will be found there if the computer is told to print out the value on the top of the stack.

A word could be developed that might be used in a calculator-style application with the word ADD. This is done with a colon (:) definition:

```
:ADD + ;
```

This would take two numbers from the stack, add them and then print the result.



That is the effect of the full stop (.). The semi-colon (;) must end all colon definitions. The user would now just type:

```
78ADD <RETURN>
```

and the machine replies '15 ok'.

Now that we have seen an application that can be used, let's look more closely into the language.

First, Forth can be implemented in several ways. I have tried tape, disc and ROM. The first two are available from Acornsoft and Level 9 Computing, the ROM version from HCCS. As with any language that you load into RAM, you lose some of the mode calls—typically you cannot go below mode 4. The ROM gives you all the space and very fast graphics as well.

The programs in the article have been run on all the systems, this having been made possible by the uniformity imposed by the Forth Interest Group (Fig). There are two main types of Forth in use, Fig-Forth and Forth-79. The differences are small, as all the main words are clearly defined. I have even written in Acorn Forth and sent the ASCII source code to another computer for compiling and running, having tested it on a BBC. Try doing that

with some other languages!

The general differences in the dialects appear to derive from the way different systems use their editor. Extra words are available, of course, to use functions such as VDU commands, but these are not really necessary, for it is not difficult to add your own words when, say, you want a graphics application. This saves filling memory with unwanted commands.

Let's look at some of the most important words. There are a number of stack operations, all of which can be tried out as soon as the language is loaded. Remember that a comment like '!' is used to represent a common word (you don't need the quotes).

Typing 23 will put those numbers onto the stack. 'DUP' then '...' will give 332. You made a copy of 3. Now the stack is empty, try another print. Notice the order. It is a LIFO stack, meaning 'last in, first out'.

To make a copy of the second item on the stack:

```
34'OVER'!...
```

This is useful when doing the following: $a*(a+b)$. Conventionally Forth programmers write a 'stack picture' if they want to sort out what is going on, so we

AN 800K DISC DRIVE SYSTEM. A RECORD £380.

If you're upgrading your BBC Micro to a disc system, you can get unbeatable value from Opus.

For instance, you can buy an Opus 5800 drive with 400K single density, for only £259.95.

And for only £120 extra, we'll give you our new double density disc interface.

Specially developed by us, it effectively

doubles the capacity of your drive, giving you an 800K system for only £379.95. And that includes VAT and carriage.

Our Double Density Interface can be supplied with any of the disc drives listed below. And it is not available anywhere else except Opus.

To place your order, post the coupon or buy direct at our showroom.

OPUS 3" MICRODRIVE.

Double Sided 40 Track Drive 1/2 Megabyte Unformatted.

- Twice the capacity on line of other available drives
- 200K. Single Density - 400K. Double Density
- Ex-stock delivery
- 3 ms. access time
- Lowest power consumption - direct drive
- Includes case, leads and utilities disc
- Totally compatible with 5 1/4" drives

Single Drive **£229.95.** Dual Drive **£459.95.**

5 1/4" JAPANESE DISC DRIVES.

SINGLE DRIVE.

Opus 5401 Single Sided 40 Track - 250K.

Unformatted. Formatted: 100K. Single Density.
200K. Double Density. **£179.95**

Opus 5402 Double Sided 40 Track - 500K.
Unformatted. Formatted: 200K. Single Density.
400K. Double Density. **£229.95**

Opus 5800 Double Sided 80/40 Track -
1 Megabyte Unformatted. Formatted: 400K.
Single Density 800K. Double Density. **£259.95**

Opus 5802 Double Sided 80 Track - 1 Megabyte
Unformatted. Formatted: 400K. Single Density.
800K. Double Density. **£279.95**

Switchable 80/40 Track.

- 1/2 Height
- Includes case, leads and utilities disc

DUAL DRIVES.

All Dual Drives are metal cased with separate power supply.

Opus Dual 5401D. Single Sided 40 Track
200K./400K. on line **£379.50**

Opus Dual 5402D. Doubled Sided 40 Track.
400K./800K. on line **£459.95**

Opus Dual 5800D Double Sided 80/40 Track.
800K./1.6 Megabyte on line **£499.95**

Opus Dual 5802D. Double Sided 80 Track.
800K./1.6 Megabyte on line **£569.95**

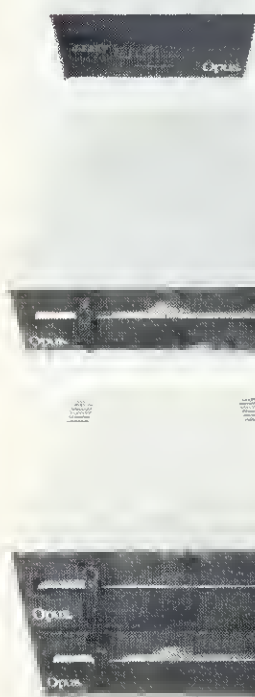

DOUBLE DENSITY DISC INTERFACE

The ultimate Acorn compatible disc interface for your BBC micro.

- Utilities on ROM including: Format and verify, tape to disc transfer, automatic 40/80 track selection, automatic density selection, unique mass copy routine, powerful machine code operating system giving up to 248 files, 80% faster than single density Easy to install.
- Free user manual supplied. **£120.00**

MONITORS.

12" Green Screen **£89.95**

12" Amber Screen **£99.95**

Lead to connect to BBC Micro **£3.95**

- Ex-stock delivery
- 24 MHz Bandwidth
- Limited quantity

14" JVC Colour Monitor - Med. Res. **£221.89**

14" JVC Colour Monitor - High Res. **£279.39**

THE ORGANISER DESK.

- Top shelf for Monitor/Printer
- Large Desk Top Area
- Lower Shelf for Paper/Book Storage
- Teak Finish
- On Castors
- Self Assembly
- Ample room in front of the shelf for you to sit comfortably.

Only **£59.95**

FLOPPY DISCS.

3" Cartridges **£5.75** each or **£25.95** for 5.

5 1/4" Discs - with full 5 year warranty + free plastic library case.

S/S/S/D **£19.95** for 10

S/S/D, D **£23.95** for 10

D/S/D/D **£26.95** for 10

S/S 80 Track **£29.00** for 10

D/S 80 Track **£31.95** for 10

8" Discs.

S/SS/D **£21.50.**

S/S/D/D **£28.50.**

D/S/D/D **£29.95.**

GOVERNMENT & EDUCATION DISCOUNTS GIVEN. QUANTITY DISCOUNTS GIVEN. DEALER ENQUIRIES INVITED.

OPUS SUPPLIES LTD.

158 Camberwell Road, London SE5 0EE.

Opening hours: 9.00-6.00 Monday Friday

9.00-1.30p.m. Saturday

01-701 8668

01-703 6155

STOP PRESS.

Opus products are available from WH Smith, Spectrum, John Menzies, Alders and other stores.

ALL ITEMS ARE GUARANTEED FOR 12 MONTHS AND ARE SUITABLE FOR USE WITH BBC AND OTHER LEADING MICROS.

To: Opus Supplies Ltd., 158 Camberwell Road, London SE5 0EE. Please rush me the following. (ALL PRICES INCLUDE VAT & CARRIAGE.)

Quantity	Description	Price
		TOTAL

I enclose a cheque for £_____

Or please debit my credit card account with

the amount of £_____

My Access: Barclaycard (please tick) No. is _____

Name _____

Address _____

Telephone _____

Opus. AU18
Opus Supplies Ltd.

can work out the procedure as follows:

```

a b on the stack
OVER  a b a
+     a b + a
*     a*(b + a)

```

This can be tested in direct mode. Now write a new word – any name up to 31 letters. Always begin with a colon and end with a semi-colon:

```
: formula OVER + * .;
```

To use it just put the values on the stack using the 3 4 formula and out pops the answer.

The Forth application from Level 9 includes a good version of Logo and good editor facilities. The Acornsoft and HCCS editors are line editors. If you are going to write a number of words to make up an application it is nice to keep the source code, which is done by means of

the editor. A 'screen' is built up at a time consisting of just 1024 bytes (16 lines of 64 characters). Each new word can be tested before the next is written, thus greatly reducing debugging time. Then the word is entered into the current screen, saved and called back and compiled. Comments can be included in each screen by means of brackets, as can be seen in the example below. Several screens can be linked together, and machine code routines can be built in if needed.

Listing 1 is a less trivial application that shows the power of Forth. It examines the memory, starting at a point in memory, looks at the next n location and prints out the ASCII code alongside – a memory dump, in fact. The screen lines are numbered and the comments are in brackets. Note the ease with which you can change base.

With two numbers on the stack, first the starting address then the number of bytes, use the program as follows:

```
8000 50 DUMP <RETURN >
```

lists 50 hexadecimal bytes from 8000 HEX onwards.

The stack moves like this:-

```

ADDR N DUMP
N ADDR OVER
N ADDR ADDR DUP (DUPLICATE)
ADDR ADDR N ROT (ROTATE 3rd item
to top of STACK)
ADDR ADDR + N +
ADDR + N ADDR SWAP (This gives our
limits for the count like a FOR ... NEXT
loop)

```

This looks a lot with all the comments, but in fact is only 12 lines altogether. Loaded and compiled into memory, it takes only a small number of bytes. Notice that the job is easy to break down into simple sub-jobs, each of which can be coded individually. Once LETOUT has been defined, it can be tested.

Line 4 is needed only on the HCCS version as there is no J loop counter, but that is not a real problem. Most books on Forth say that if you are nesting more than twice you should be doing it another way!

Listing 1. A memory dump in Forth

```

1 HEX ( select HEXadecimal )
2 3000 CONSTANT NO 8 NO C! ( a memory location called NO with 8 stored in
it )
3 3001 CONSTANT buff ( a memory location called buff where 8 bytes will be
stored)
4 : J RP@ 7 + @ ; ( define a second loop counter J )
5 : LETOUT buff NO @ TYPE ;
( The main VERB is DUMP )
6 : DUMP CR OVER DUP ROT + SWAP DO
( Inner LOOP 1 8 BYTES adding I and J gives real ADDRESS C@ FETCHES the
value, make a DUPLICATE PRINT it in 3 columns justified from the Right )
7 8 0 DO I J + C@ DUP 3 .R
( DUPLICATE it again AND test for the limit 20 HEX to 7A HEX )
8 DUP DUP 20 > SWAP 7A < AND IF
( IF it is store it in our buffer Index by I ELSE forget it DROP and put a
DOT 2E instead )
9 I buff + C! ELSE DROP 2E
10 I buff + C! THEN LOOP
( DO all 8 times then goto LETOUT to TYPE the 8 ASCII characters )
11 2 SPACES LETOUT
( Carriage Return on a new line and jump 8 in the J LOOP )
12 CR 8 +LOOP DROP ;

```

FURTHER READING

- 'Starting Forth' by Leo Brodie (Prentice-Hall)
- 'Forth on the BBC Micro' by R de Grandis-Harrison (Acornsoft)
- 'Welcome Forth' by J W Brown (HCCS)
- 'The Complete Forth' by Alan Winfield (Sigma Technical Press)
- 'Forth Programming' by Leo Scanlon (Blacksburg)

B-TREES

◀ page 49

tree% (25). Since leaves hold no information they can be represented by a special pointer value, not used elsewhere, leaf%. FNgetnode initialises the new node with leaf% in all its pointers, and a number larger than any possible key, infinity% for all its keys.

The algorithm for lookup is similar to that for a binary tree. To find an item x:

1. Take the root as the first node.
2. Starting with the largest key, and working down, find the first key so that key <= x.
3. If there is no such key take the node pointed to by p₀. If this is a leaf STOP – key not found, ELSE GOTO 2
4. If the key = x then STOP – key found, ELSE take the node pointed to by the corresponding pointer (eg, if the key is k₁ take p₁).

5. If this is a leaf STOP – key not found ELSE GOTO 2
The function FNfindplace is used to do stage 2.

Insertion is rather more complex. We use a similar lookup method to find where in the bottom level of the tree to put the new item (FNinsert and FNdoinsert). If there is room in this node we use PROCinsert to add the new item and return TRUE to indicate successful insertion. Otherwise, we call PROCsplit to split the node in two. We get a new node.

In the old node we leave p₀ and the three smallest keys and their associated pointers. In the new node we put the three largest keys and their pointers as the bottom three keys and pointers. This leaves a key and a pointer. The pointer becomes p₀ of the new node. The new node is put in resptr% and the remaining key in reskey%. These then must be inserted into the parent node as a new key pointer pair on return. FNdoinsert duly

returns FALSE to indicate that this must be done to FNinsert. The whole process then repeats recursively.

B-trees are particularly valuable for databases stored on disc. In this case the nodes become blocks on the disc and pointers are the position of the block on the disc. Nodes can be much larger to take advantage of the size of a block (256 bytes on the Beeb DFS), and since they are always guaranteed to be at least half full they make efficient use of the space. Finally since the tree is always balanced, we know that the worst-case time for lookup is minimised.

If you wish to implement a database using B-trees you'll need additional information. Implementation details are well covered in *Data Structures and Algorithms* by Aho, Hopcroft and Ullman (Addison-Wesley, 1983). The use of B-trees for databases is explained clearly in *An Introduction to Database Systems* by C J Date, third edition (Addison-Wesley).



Software News

INNOVATIVE
BBC SOFTWARE



from the professionals

ROM UTILITIES FOR THE BBC !

MOLI-TOOL

Moli-Tool is an essential programming aid/utility for the BBC Basic Programmer. As it is supplied on an EPROM it simply pops into the socket in the BBC and is constantly available for use.

★ **CHANGE** — Used to alter one variable name to another, or one string to another string within the program.

★ **CHARS** — A quick reference chart which displays normal ASCII characters and user defined characters, with a cross reference to the character number.

★ **FIND** — Finds virtually anything, that the user specifies, in the program. PROC, names, single letters, or whatever, FIND will give you the line number.

★ **FNKEY** — Displays the definitions or functions allocated to the function keys.

★ **MEND** — If you have a bad load, MEND will rescue whatever part of the program was loaded in.

★ **MEND+** — Mends programs which have been in memory but have since become corrupted.

★ **MOVE** — Moves a Basic program up or down in memory.

★ **STRIP** — Takes out all unnecessary spaces or REM statements.

★ **PAD** — Puts spaces back in.

★ **VAL** — *Extremely* useful. Supplies you with a list of the values of any current variables.

★ **VLIST** — Lists all referenced variable names in the program.

£28.00 + £1.00 p & p + V.A.T.

MICROMON

A powerful de-bugging tool and monitor, available on EPROM or tape. Micromon contains 23 commands which are as follows and are self-explanatory.

1. Modify memory in ASCII.
2. Modify memory in hexadecimal.
3. Set a breakpoint.
4. List all breakpoints.
5. Remove a breakpoint.
6. Display memory.
7. Execute a CALL.
8. Find a stipulated string.
9. Find a stipulated byte.
10. Execute a jump to a specified address.
11. Disassemble a stipulated section of memory.
12. Disassemble memory to the printer.
13. Change the contents of a register.

14. Change the contents of the program counter.
15. Trace the execution of a program by single stepping.
16. Skip the next instruction in single stepping.
17. Single step the next instruction.
18. Dump a stipulated section of memory to the printer.
19. Dump the screen to printer.
20. Plug memory, that is to say, load a stipulated byte into a block of memory.
21. Move a block of memory from one part of memory to another.
22. Move the memory display down by 64 bytes.
23. Move the memory display up by 64 bytes.

EPROM £28.00 + £1.00 p & p + V.A.T.

TAPE £14.00 + £1.00 p & p + V.A.T.

TEL: (0424) 220371/222578

MOLIMERX™ LTD

A J HARDING (MOLIMERX)

TELEX 86736 SOTEX G

1 BUCKHURST ROAD, TOWN HALL SQUARE, BEXHILL-ON-SEA, EAST SUSSEX.

SOFTWARE CATALOGUE ——— A4 size stamped addressed envelope for 17p.

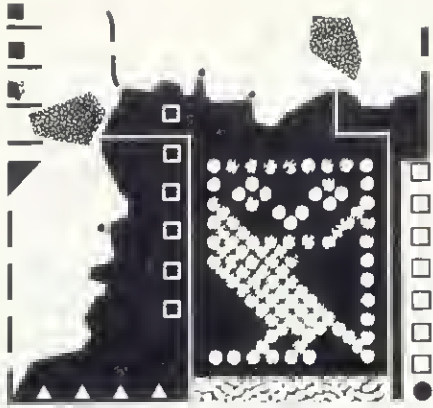

George Hill, your host this month, takes up the tape-to-disc challenge – plus random numbers, error reporting, Assembler quirks

Transfer to disc

IN THE December Beeb Forum Ian Birnbaum suggested someone should adapt his one-line tape-to-disc transfer routine to cope with all sorts of programs.

The process isn't simple, and the only way to get all types of program loaded and saved is to use a *LOAD command at a fixed address, followed by a *SAVE from the same fixed address. The *SAVE command requires the program length.

The result of this *SAVE will be to deposit the correct information on to the disc in the *program* but will leave the file information (read by *INFO) in a useless state. It will contain the same fixed address for all files, and the file-length, but no record of load and execution addresses.

Users of machine code may have met similar trouble already. Suppose you have written an assembly language program which assembles the code correctly and is position-independent, but occupies the space in which you need to assemble the code. What I have done in the past is to save the assembler program, alter PAGE, re-load the program out of the way, reassemble, and save the code.

OSFILE can help avoid all this. OSFILE is an operating system routine, called via &FFDD, which carries out tape and disc housekeeping activities. A short article in the October 1983 issue (page 66) showed how OSFILE can load and merge programs and tell if a file exists. It can also be used to change the file information for an existing file on a disc, including the modification of the name and the various addresses without touching the file contents. *RENAME uses the routine.

The transfer programs work as follows.

Program 3 is a loader program (see yellow page iii) which contains at line 0 the 'auto-run' routine by A Oliver (Forum, October, page 52). It then shifts PAGE down to the minimum value under which the disc filing system will operate (thanks to Joe Telford for this). It then chains the main program which carries out the transfer.

Program 4 is the business program and uses mode 7 to give access to as much memory as possible. As the program is now located at &1100, HIMEM can be set to &1900, restricting the working area of the loading and saving program and freeing the whole memory from &1900 to

&7BFF as a 'buffer' for programs, files and so on. OSFILE is defined, and space for the program name and the required control_block for OSFILE to work in are reserved by the DIMs. The first two bytes of the control_block are now made to 'point to' the name. X% and Y% are similarly made to point to the control_block, in preparation for the CALL to OSFILE.

Now TAPE is selected, and the options set to give full messages (*OPT1,2) and to abort if a read error occurs (*OPT2,2). This latter may not be what you want, in which case omit it. The screen is now cleared and set up so that the Birnbaum screen reading method can be used. This finds the program's name, its length, its load address and execution address. These are extracted from the screen memory in PROCsave_file. The next file on the tape is loaded in at address &1900.

The filing system is switched to disc, and the values of A\$, B\$, C\$ and D\$ are made equal to the strings on the screen at the end of the *LOAD operation with *OPT1,2 on. These are, for example:

```

A$= "SCREEN"  B$= "0000"  C$= "0000"  D$= "0000"

```

for the Basic program Screentest. The information appears on line 5 of the screen, which starts at memory address &7CC8 (HIMEM + 100).

The name presents a problem as some tapes (eg, the Forth language tape) contain four or five programs with the same name. The transfer program as it stands will simply overwrite each identically-named program with the succeeding one. This can be got round by fiddling the names. One other suggestion would be to have a 'rolling' directory letter added to each program as it loads, so the first is A.FORTH, the second B.FORTH, etc. The transfer program reads only the first nine letters of the name (I% = 0 to 8 at line 300); and cuts out the last two, unless there is a full stop (indicating a directory letter) at position 2 (line 320).

Whatever you do, you must ensure that the final name is either:

```

< one letter > < seven letters >
Or
< seven letters >

```

otherwise there will be a fatal error. The space reserved for the name is now poked (\$name = ...) with the name, followed by a carriage return (CHR\$13).

The control_block is now emptied and re-set so bytes 10 to 13 contain the start address for the *SAVE, and bytes 14 to 17 the end address. The end address is the start address (&1900) plus the value of B\$ in hex, calculated using EVAL ("&" + B\$). A% and byte 6 of control_block are both set to 0 for a *SAVE command, and OSFILE is called.

To adjust the addresses, a further call to OSFILE is required. A% is set to 1, and the load and execution addresses and the length are plinged (!) into the required places in the control_block (bytes 2 to 5, 6 to 9, and 10 to 13, respectively). Byte 14 is set to 0, giving 'open access' files. If you want to produce 'locked' files line 540 would be

```
540 control_block !&E = 2
```

See the article 'Protection racket' in February's issue for a simple routine to deal with locked files.

The following ideas could be used to develop the routine. First, note that the OS keeps a copy of the current filename and file information when loading from tape. This is located in page 3 at addresses as follows:

```

&3B2 to &3BD – Filename (terminated by 0)
&3BE to &3C1 – Load address
&3C2 to &3C5 – Execution address
&3C8 to &3C9 – Length of file (note only two bytes).

```

These can be used as an alternative method of obtaining the file information, replacing the Birnbaum screen read.

Next the method of causing the changing of PAGE to &1100 for the running of the program has been superseded by STARRUN in the March issue.

Third the whole process can be accomplished via OSCLI using the fourth (undocumented) parameter, which is the RELOAD address for a file.

The disc copies produced will be exact copies of the files on the tape. They will not

Beeb Forum is a platform for ideas, tips and applications relating to the BBC micro and the Electron, intended for experienced programmers to share their thoughts. For every reader's tip published we pay £5 – or more for something special. Contributions should be typed or printed, with substantial listings on cassette. WRITE TO Beeb Forum, Acorn User, Redwood Publishing, London WC2E 9JH.

Previously you would need a ROM for these sort of features...so compare with anything on the market today—at over twice the price—and you will buy the



KANSAS WORD PROCESSOR

ECC—Embedded Control Characters—the method the professionals use

FACILITIES

Tape or disk
Holds 4,200 words in file
Selective search
Global search
Replace words selectively
Format to video or printer
Continuous printing
Separate sheet printing
Draft copy option
Select single or double spacing
Adjustable page length
Optional page numbering
Adjust left margin (4 options)
Adjust line length (4 options)
Centre text
Right justify
Print enlarged text
Print condensed text
Print emphasised text
Print normal text
Underscore on/off
Gives text area used
Gives text area available
Estimates memory location
Display pages
Insert text/ECCs to file
Delete text/ECCs from file
Move up to 255 characters
Duplicate up to 255 characters
Edit whilst adding text
Edit complete text file
Safeguard to Basic
Save file to tape/disk
Load file from tape/disk

ECC means that you are able to type away regardless of line ends, margins, new lines or new paragraphs, as ECC does it all—automatically.

All it requires is the pressing of the TAB key and a single letter, and hey presto! you have a new paragraph, with of course a line space and indentation, exactly where you want. Other ECCs will adjust line lengths, varying indentions or even change the printing characters.

Though originally designed for the professional, it is by far the best method for the two finger typist, as there is no need for the amateur to take his or her eyes off the 'copy' to see when the end of a line is reached. The Kansas Word Processor sorts out all the split words during the Format stage, at the same time as adjusting the length of line to suit either the video or the printer.

Though most so-called Word Processors for the BBC are nothing more than letter writers, with the user having to set out paragraphs, indentions, etc., the Kansas Word Processor is exactly as the title states, a word processor. It is thus suitable for any purpose requiring printed words, reports, articles, lists, minutes and of course letters.

The ability to produce as many original copies as required makes it ideal for when more copies are needed as can be done with a typewriter and carbons yet where copying facilities are not readily available. And of course, not only can "hard" copy be produced on paper, but copies can be saved to either disk or tape, for future reference, use or editing.

As a single file will hold well over 4,000 words, articles, stories and the like can be easily accomplished, saving each file separately, for subsequent editing then printing as a whole.

In fact the possibilities for the uses of the Kansas Word Processor are endless, owing to its sheer versatility. It really is a must for anyone with a printer...

For sheer ease of use all the following controls are single keystroke toggling on the function keys:

Add, Edit, Search, Replace, Save Text, Load Text, Inform, Exit Processor, Enter Processor, Clear Text Area, First Page, Next Page, Previous Page, Last Page, Insert Text, Delete Text, Insert Buffer, Clear Buffer, Format, Print.

ADD Allows the inputting of text and the embedded control characters, continuously, with no need to adjust words to fit line ends.

EDIT The full scope of the BBCs editing facilities apply both during the adding of text and when completed.

SEARCH Search for any group of characters. Will show the position of each occurrence.

REPLACE Used in conjunction with the Search facility, you can replace existing characters with new characters. This can either be global or selective. If global is selected, every occurrence of the characters will be replaced. If you select selective, the program will display every occurrence and you will have the option to replace or not.

FORMAT This allows the formatting of the assembled text file, giving various options as to page length, numbering, spacing, video or printer, etc.

PRINT Gives the options of draft or emphasised; continuous or single sheets; double or single spacing; page number and first number; lines per page; number of copies required.

SAVE TEXT Allows the saving of the current text file to tape, with an option to save to disk.

LOAD TEXT This loads a text file from tape (with the option of disk). Numerous text files can be loaded as the one loaded does not destroy the text file already in the program.

INFORM This gives the information of the file in memory and the space still available.

EXIT PROCESSOR This will return the computer to Basic, which is useful for *CAT text files, etc, and to position tapes for loading or saving text files. You will not destroy either the resident text file or the program.

ENTER PROCESSOR Used to enter the program after using the previous command.

CLEAR TEXT AREA Resets all text pointers, clearing text.

FIRST PAGE NEXT PAGE PREVIOUS PAGE LAST PAGE The commands display the text page as asked.

INSERT TEXT Use of cursor keys to insert text or ECCs into existing text file.

DELETE TEXT Use of cursor keys to delete text.

INSERT BUFFER A buffer holding up to 255 characters can be used to either move or duplicate text anywhere in the file, even from page to page.

Complete package includes extensive instruction manual and fuction keys strip

Supplied on cassette with disk conversion instructions

£22.50 All inclusive

Kansas

Recognised Brand Leader in microcomputer software



Kansas City Systems, Unit 3, Sutton Spings Wood, Chesterfield, S44 5XF. Tel: 0246 850357

necessarily run in the form in which they appear, though you will be able to LOAD, *LOAD or *EXEC them. Details of the pitfalls and tricks of tape-to-disc adaptation would occupy another article.

'Perfectly random'

IN DECEMBER'S issue, John O'Brien asked for a way to obtain a 'perfect' sequence of random numbers where no number duplicates itself. Philip Blythe of Aylesbury has provided just such a routine for the Electron and BBC micro, which is given as program 5.

Program 5. 'Perfect' random number routine by Philip Blythe

```

10 MODE 7
20 DIM X(10)
30 A=1
40 REPEAT
50 T=RND(10):Q=1
60 IF X(Q)=T THEN
70 Q=Q+1
80 IF Q<10 THEN GO
90 X(A)=T:A=A+1
100 UNTIL A>10
110 PRINT "Perfect
random numbers"
120 FOR P=1 TO 10
130 PRINT X(P)
140 NEXT
    
```

Wrong messages

A PROCEDURE from Andrew Woods of Fruitgum Software(!) allows a user to create error conditions in a program so the error message (errors\$) will be printed by REPORT and the error code (error%) by PRINT ERR.

The routine (program 6) may be placed anywhere in RAM, except zero page, by altering the value of e% in line 1010. Line 1060 may be omitted and placed anywhere in the program so that once the procedure has been run once, it may be called from any part of the program. Similarly, other messages may be placed in RAM and called as needed.

For example:

Program 6. Procedure to alter error handling by Andrew Woods

```

1000 DEFPROC error (error%, error$)
1010 e%=&2F00
1020 ?e%=0 : REM 0 is BRK in machine code
1030 e%?1=error% : REM value for ERR
1040 e%$2=error$ : REM message for REPORT
1050 e%?LEN(e%$2)=0
1060 CALL e%
1070 ENDPROC
    
```

Program 7. Function key definitions prevent sideways ROMs interacting. By Mark Clegg

```

10 *KEYOCLS:I."Disable Rom-"I%:J%=I%+
&2A1:?(&70+I%)=?J%:?J%=0:IM
20 *KEY1CLS:I."Enable Rom-"I%:J%=I%+&2
A1:?J%=?(&70+I%):IM
30 *KEY2CLS:@%=3:P."Rom types-"":F.I%
=&2A1TO&2B0:P."ROM",I%-&2A1,"IS TYPE"??I
%:N.:P."?":IM
    
```

10 IF A% < 0 PROCerror (100, "You entered a negative number")

will produce:

You entered a negative number

when REPORT is entered.

The value of error% may be trapped in an ON ERROR routine:

```
100 IF ERR = 100 GOTO...
```

The routine will work on the Electron and BBC micro.

ROM in command

HERE is a tip for all those BBC micro users who have several paged ROMs installed, and have found that two or more ROMs recognise the same command. The function key definitions in program 7 will allow selective disabling of any ROM so that all the commands provided by the disabled ROM effectively no longer exist and any commands which were duplicated in other ROMs may now be used (OS 1.2).

Key f1: Disable a particular ROM by its number.

Key f2: Re-enables a disabled ROM, again by number.

Key f3: Gives a list of the current ROM types.

When using f1 and f2 the system asks for the ROM to be dis/enabled. This should be entered as a number in the range 0 to 15 where the number is the actual device number of the ROM to be acted upon. In the Beeb, the four paged ROM sockets are numbered 12 to 15 reading from west to east with the keyboard facing towards you.

If any ROM expansion boards are fitted, the manufacturer's data should be con-

sulted for the ROM numbers.

Mark Clegg from Rossendale provided this tip.

Assembler quirks

MR SHILL from London has pointed out a difference in the way Basic and the Assembler in the BBC micro and Electron handle expressions containing illegal hex values. When confronted with:

```
PRINT &20E (that's O not zero)
```

Basic returns the error message 'no such variable'. The O and all the following characters are ignored.

However, the Assembler acts differently. The expressions:

```
LDA #&20E or LDA &20E
```

are assembled as

```
LDA #&02 or LDA &02
```

repectively, but no error message is generated, even if OPT 3 has been selected!

The reason for this lies in the routine the Assembler uses to evaluate the hexadecimal number, which is so written that it exits when it meets the first non-hex character. Therefore, the ASCII hex to binary conversion routine within exits on meeting the O -- after the 2 has been correctly evaluated and is subsequently assembled as the operand.

Another quirk of the way this conversion routine works is that if more than two bytes are expressed as an operand address it is the last top bytes that are assembled, any preceding bytes are dropped. Thus the line

```
LDA &CAFE9
```

would be assembled as:

```
AD E9 AF LDA &CAFE9
```

the address assembled as the operand being &AFE9.

The subject of Os and 0s throws up an interesting challenge. It would be useful if the Beeb could be made to interpret O as 0 if it was obviously being used to form a number, be it hex or decimal. Can anyone provide a routine that will allow this? £10 awaits the best solution which is transparent to the user.

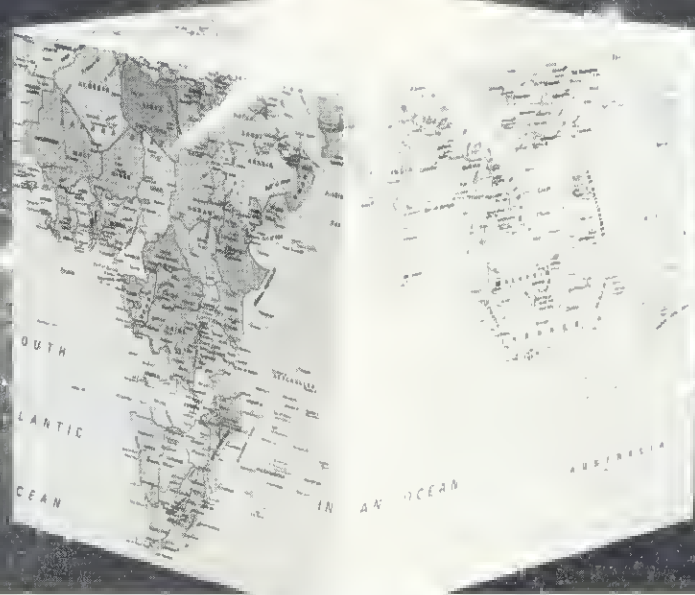

APPROVED for use with telecommunication systems run by British Telecommunications in accordance with the conditions in the instructions for use.

Everything's remotely possible with Telemod 2. At around £84.

Telemod 2 takes you and your micro into a whole new world of possibilities and opportunity.

Take Prestel* for example. For news, travel and holiday information, Teleshopping, Homebanking, Telex, and CitiService financial information.

Or explore Micronet 800, where hundreds of free games are yours for the choosing, as well as an ever-expanding range of educational, household and business software.

Take advantage of electronic mail by exchanging messages and programs with other users – anywhere in the world!

The Telemod 2 from OEL (Europe's largest volume manufacturer of modems) uses advanced IC technology to bring universal communications with enhanced reliability – at a down-to-earth-price.

To make the most of Telemod 2, we offer a comprehensive choice of viewdata communications packages for popular micros such as BBC, Apple II, and IIE, CBM 3000, 4000, & 8000-64 and Tandy Models I & III. These packs contain appropriate interfaces and software, any necessary connectors, and full instructions. Prices range from around £15-£60.

With Telemod 2, you can simply turn the remotest possibilities into reality. Just return the completed coupon first.

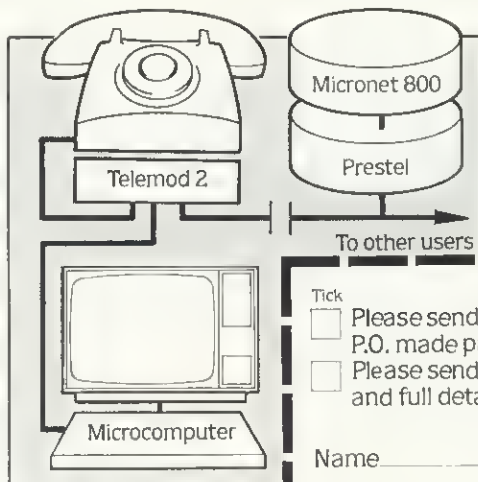

Tick Please send me the Telemod 2. I enclose a cheque/ P.O. made payable to O.E. Ltd for £84.95 inc. VAT.†

Please send me more information on the Telemod 2 and full details about communications packages.

Name _____

Address _____

_____ Tel _____



O.E. Limited
North Point
Gilwilly Industrial Estate
Penrith, Cumbria CA11 9BN
Telephone 0768 66748
Telex 64157 Electronic Mailbox No. 093051909

*Prestel and the Prestel symbol are trademarks of British Telecom in our nation.
†Please allow 3 days for delivery.

**UNREPEATABLE BARGAIN OFFER
FROM MIDWICH
ONLY WHILE STOCKS LAST!
1,000 BBC MICRO COMPATIBLE
DISC DRIVE UNITS
TO CLEAR**

£99.95
INC. VAT

(SIMILAR MODELS AT LEAST £200 ELSEWHERE)

Includes connecting cable, DFS Manual and Formatting Disc.

We need to clear our stocks of brand new Shugart SA 410 Disc Drive Units, to make way for new merchandise in our warehouse.

Each 5¼" standard height drive has a 200K, single side, 80 track capacity and includes manufacturer's full warranty.

Cash with order only to include carriage at £3.50 per drive.

Telephone your credit card order now.

HURRY, OFFER ONLY APPLICABLE WHILE STOCKS LAST.

MIDWICH
COMPUTER COMPANY LIMITED

RICKINGHALL HOUSE, HINDERCLAY ROAD, RICKINGHALL, SUFFOLK IP22 1HH. TELEPHONE : DISS (0379) 898001.

PRINTER EXTRAVAGANZA

Order Today
Print Tomorrow
24 HOUR DELIVERY

We challenge you to find a better deal!

EPSON PRICE CRASH

The only
printer firm
OPEN 7 DAYS
A WEEK

MAKING WAY FOR THE NEW **Star**'s

EPSON RX80 (DOT MATRIX)	£199 + VAT =	£228.85
EPSON RX80FT (DOT MATRIX)	£229 + VAT =	£263.35
EPSON FX80 (DOT MATRIX)	£314 + VAT =	£361.10
EPSON FX100(DOT MATRIX)	£415 + VAT =	£477.25

THE FABULOUS **Star** DOT MATRIX PRINTERS
The power behind the printed word.



STAR GEMINI 10X	£198 + VAT =	£227.70
STAR DELTA 10	£325 + VAT =	£373.75
STAR GEMINI 15X	Ring for stupid prices NOW	
STAR DELTA 15	£499 + VAT =	£573.85
STAR RADIX 10	£499 + VAT =	£573.85
STAR RADIX 15	£599 + VAT =	£688.85

WE WILL MATCH ANY GENUINE PRICE ADVERTISED
SCI(UK) IS NEVER BEATEN ON PRICE

MANY MORE PRINTERS AVAILABLE - 1000's OF SCI(UK) BARGAINS
SEND NOW FOR THE **FAMOUS** SCI(UK) CATALOGUE



for cheapest prices telephone 0730 63741 or 0730 61745



MORE SCI(UK) BARGAINS

SHINWA CP80	£189 + VAT =	£217.35
BROTHER EP44	£199 + VAT =	£228.85
CCP 40 Colour printer/plotter ...	£109 + VAT =	£125.55
RITEMAN A1	£229 + VAT =	£263.35
FIDELITY 14" Colour monitor/video	£189 + VAT =	£217.35

DAISYWHEEL PRINTERS

JUKI 6100	phone for stupid price
DAISEYSTEP 2000 ...	£279 + VAT = £320.85
UCHIDA DWX305 ...	£279 + VAT = £320.85

MCP 165 (DOT MATRIX - NLQ) £325 + VAT = £373.75
*(the most amazing DM printer we have ever sold.)
Telephone now for details*

We have interfaces for all types of computers, including CBM 64, VIC 20, APPLE, TRS 80, IBM, BBC, SPECTRUM, QL, etc.

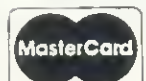

BEAT THAT

24 HOUR SECURICOR DELIVERY £9.50 plus VAT • BANKERS ORDERS, BUILDING SOCIETY CHEQUES, POSTAL ORDERS - SAME DAY
ALL ORDERS COVERED BY THE MAIL ORDER PROTECTION SCHEME • NATIONWIDE MAINTENANCE CONTRACTS ARRANGED
EDUCATIONAL DISCOUNTS VERY WELCOME

Its **SUNDAY** - Do you realise you can order **NOW** - We are open **7 DAYS A WEEK**.

DEALER ENQUIRIES WELCOME
WRITE FOR DETAILS

SCI(UK)

SCI(UK) FREEPOST (No Stamp needed)
PETERSFIELD HANTS GU32 2BR

0730 61745
0730 63741

EXPORT ENQUIRIES
NO TAX
DELIVERY AT COST

Personal callers welcomed. Unit 16, Inmans Lane, Sheet, PETERSFIELD, Hants. TELEX 86626 MYNEWS G

LEADER OF THE PACK

Alan Samuels deals a useful hand of routines for brighter play

THE most alluring aspect of any game is usually the graphics. Even the most uninteresting program can be enhanced by putting pictures on the screen. Take a card game, for instance – Pontoon, Whist, Patience – where the images are an essential ingredient. The first step is to produce a blank card that may be printed in any colour at any position on the screen.

There are two ways of doing this. First the card may be produced by means of filling in two adjacent triangles with the PLOT 85 command as follows (see also full program, listing 1, yellow page iv):

Part 1

To produce the card, type:

```
MODE 1 then PROC_draw_card(A,B,C)
```

where A is the horizontal position across the screen on which the bottom right hand corner of the card should be situated and B its vertical position up the screen (figure 1). C is the colour that it is to be printed in (figure 2). For example:

```
PROC_draw_card(540,360,3)
```

will print a card in the centre of the screen in white.

This is done by moving the graphics cursor, first to point 1 in figure 3, then to point 2. Issuing a PLOT 85 command moves it to point 3 and colours in triangle A. The cursor is moved to point 4 and another PLOT 85 command issued, and it then moves to point 5 – the starting point – and produces the adjacent triangle B. Line 1010 defines the colour to be first.

Part 2

Another way to produce a rectangle is to define a graphics window and colour it in as follows: line 1040 is added to 'break' the graphics window once it is no longer needed. It is always good practice to do this as a graphics window accidentally left prevents the display of graphics on any other part of the screen.

As in the other method, the card is produced with the line

```
PROC_draw_card(540,360,3)
```

Now you have a method of drawing a

card (you may use either method 1 or 2) the next stage is to produce the card through a program. The x_coord and y_coord numbers can be stored in data lines and called as in part 3, for example.

Part 3

Now to producing an emblem for the back of the cards. As this is written for the BBC computer (there is no reason why it should not work on an Electron) I decided to use the BBC owl logo.

To do this you use the user-definable characters of the BBC. The first step to produce a character is to draw it as a series of dots on an 8x8 matrix. As the owl takes up more than one 8x8 matrix you will use a series of characters placed together (figure 4).

Every computer character – eg A, 1, z, ? – has a unique code. The code for A is 65, so to produce this letter you could type PRINT CHR\$(65). The codes from 224 to 255 are left blank and by using the VDU command you can define them to be any shape or character you like on an 8x8 matrix.

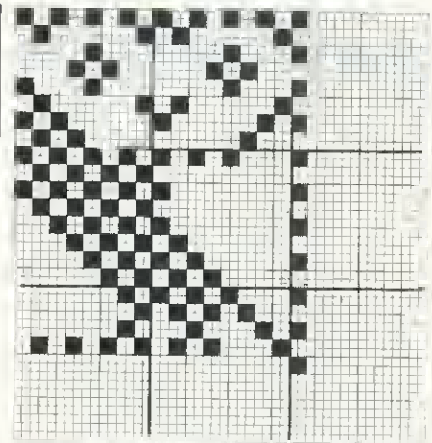

Figure 4. The owl is made up of a group of defined characters

$$0 + 2 + 8 + 32 + 128 = 170$$

Now we have to allot these numbers to a character code which may be any number from 224 to 255. Taking 224 as an example, the command would be:

```
VDU 23,224,170,65,136,20,136,65,160,80
```

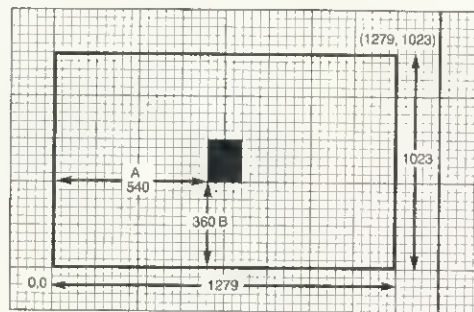

Figure 1. Position the card on the screen

To convert the shape into something the computer will understand, add up the dots as follows (figure 5): start with the 0. If the first square on the right of the first horizontal line is shaded, add 1. If the second is shaded add 2 and so on, doubling the number to be added each time. Follow this process for each horizontal line. For example, with the first character of the owl the second, fourth, sixth and eighth squares are shaded so add:

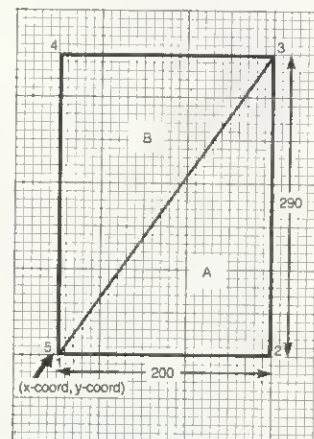

Figure 3. Drawing the card by cursor control

Black	Ø	Yellow	2
Red	1	White	3

Figure 2. Colour table for mode 1

The numbers 23 and 224 tell the computer that you are defining character 224. The other numbers are the sum of the shaded squares of each horizontal line. PRINT CHR\$(224) will print this shape.

To produce the whole owl repeat this process for each 8 x 8 matrix, not forgetting to store the numbers in different characters (the third and sixth shapes are the same so have to be defined only once).

'The emblem may be drawn anywhere on the screen'

Part 4

Line 2090 causes the variable design\$ to be all the characters of the owl added together, so the command PRINT design\$ will print the owl. (The CHR\$8 command causes the cursor to move back one space and the CHR\$10 command causes it to move down one line.) Now add in line 15 PROC_design so that the computer will know what the defined shapes are.

The next stage is to print the design on the back of the cards. To do this we define a procedure which will be called when the blank card has been drawn.

Part 5

To call this procedure you have to add a line to the procedure called PROC_draw_card. If you copied out method 1 add:

```
1065 PROC _print _design (x _ coord
+ 70,y _ coord + 170,1)
```

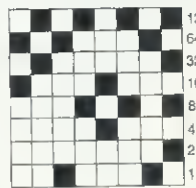

Figure 5. Converting the pattern into numbers

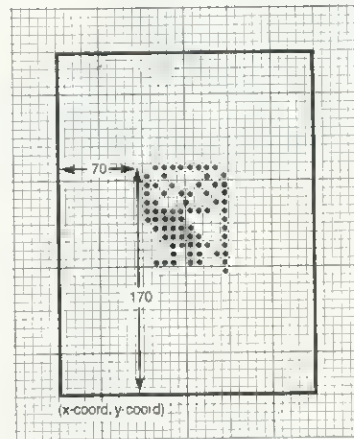

Figure 6. The design is positioned on the card

If you used method 2 add:

```
1045 PROC _print _design (x _ coord
+ 70,y _ coord + 170,1)
```

The reason for the added numbers can be seen in figure 6.

The top right of the owl emblem is 70 dots further along the horizontal line and 170 dots higher up than the bottom right

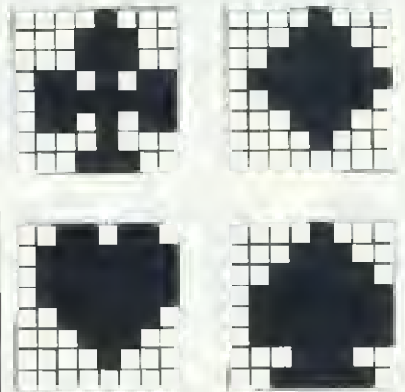

Figure 7. Shapes to suit - clubs, diamonds, hearts, spades

of the card. Line 3010 joins the text and graphics cursors so that the emblem may be drawn in an exact position anywhere on the screen instead of just any one of 40 positions on 32 lines.

In PROC_print_design lines 3050 to 3100 just add a few lines to the back of the card.

Now that you have the card design all you need is to define shapes for hearts, clubs, diamonds and spades. This is done in the same way as the owl (figure 7).

Part 6

Add line 16 PROC_characters to inform the computer of the defined characters. So to print a specific suit you merely call PROC_characters and type PRINT club\$ or heart\$, etc.

You should now have the full program (listing 1).

Part 1

```
1000 DEF PROC draw_card(x_coord,y_coord,
colour)
1010 BODL 0,colour
1020 MOVE x_coord,y_coord
1030 MOVE x_coord+200,y_coord
1040 PLOT B5,x_coord+200,y_coord+290
1050 MOVE x_coord,y_coord+290
1060 PLOT B5,x_coord,y_coord
1070 ENDPROC
```

Part 2

```
1000 DEF PROC draw_card(x_coord,y_coord,colour)
1010 VDU 24,x_coord,y_coord;x_coord+200,y_coord
+290;
1020 BODL 0,128+colour
1030 CLG
1040 VDU 26
1050 ENDPROC
```

Part 3

```
10 MODE1
20 FOR card_positions = 1 TO 100
30 READ x_coord,y_coord
40 PROC draw_card(x_coord,y_coord,7)
50 NEXT card_positions
60 END
500 DATA 360,85,620,85,880,85,160,375,620,375,
880,375
```

Part 4

```
2000 DEF PROC design
2010 VDU 23,224,170,65,136,20,136,65,160,80
2020 VDU 23,225,170,65,136,20,8,65,130,4
2030 VDU 23,226,170,85,170,85,42,21,10,5
2040 VDU 23,227,168,0,128,0,128,64,160,80
2050 VDU 23,228,2,1,2,85,0,0,0,0
2060 VDU 23,229,168,84,34,81,0,0,0,0
2070 VDU 23,230,128,0,128,0,128,0,128,0
2080 VDU 23,231,128,0,128,0,128,0,0,0
2090 design$ = CHR$224 + CHR$225 + CHR$230 +
CHR$8 + CHR$8 + CHR$8 + CHR$10 + C
HR$226 + CHR$227 + CHR$230 + CHR$8 + CHR$8 +
CHR$8 + CHR$10 + CHR$228 + CHR$229
+ CHR$231
2100 ENDPROC
```

Part 5

```
3000 DEF PROC_print_design(x_coord,y_coord,colour)
3010 VDU 5
3020 BODL 0,colour
3030 MOVE x_coord,y_coord
3040 PRINT design$
3050 MOVE x_coord-10,y_coord+80
3060 DRAW x_coord-30,y_coord+80
3070 DRAW x_coord-30,y_coord+60
3080 MOVE x_coord+80,y_coord-140
3090 DRAW x_coord+100,y_coord-140
3100 DRAW x_coord+100,y_coord-120
3110 ENDPROC
```

Part 6

```
6000 DEF PROC_characters
6010 VDU 23,232,8,28,28,107,127,8,28
6020 VDU 23,233,8,28,62,127,62,28,8,0
6030 VDU 23,234,54,127,127,127,62,28,8,0
6040 VDU 23,235,8,28,62,127,127,127,28,62
6050 club$=CHR$232;diamond$=CHR$233;
heart$=CHR$234;spade$=CHR$235
6060 ENDPROC
```

Break the BBC sound barrier!

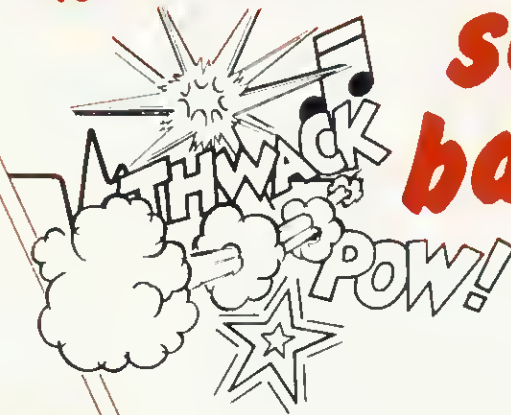

Add the power of ROM based software to your micro!

Turn your micro into a word processor, a disassembler, a multi-language machine, or a communications terminal – at the flick of a switch!

Once there was a physical limit to the number of ROMs you could use. But with our ROM extension socket you can now gain access to an infinite number of ROMs quickly – and safely.

- Zero-force insertion socket protects valuable eproms from damage
- Easy to install – no soldering
- Fits into the ashtray for easy access – no need to meddle with the micro's innards
- Full, simple to follow instructions supplied

**EXPERIENCE
A GREAT NEW
DIMENSION IN
MICRO SOUND!**

The National Micro Centres hi-fi adapter allows you to bypass the BBC Micro's internal speaker and feed the sound signal into your own hi-fi or music centre.

- Easy to install – no soldering
- Three-position switch allows use of internal or external speaker – or turns off sound completely
- Full instructions supplied
- Fully isolated unit
- Much more than an additional speaker – allows full use of your amplifier's controls

Hi-fi
adapter
ONLY
£19.95
Inc. VAT
Carriage free

ROM
extension socket
ONLY
£22.95
Inc. VAT
Carriage free

- Please supply _____ Hi-fi adapter(s) at £19.95 each inc. VAT
- Please supply _____ ROM extension sockets at £22.95 each inc. VAT
- I enclose a cheque/PO No. _____ for £ _____ made payable to: National Micro Centres
- Please charge my credit card No. _____

Signed _____

Name _____

Address _____

POST TO: NMC, 36 St. Petersgate, Stockport SK1 1HL

**National
Micro Centres**

36 St. Petersgate
Stockport SK1 1HL
Tel: 061-429 8080

SPECIAL DISCOUNT FOR SCHOOLS
Phone 061-429 8080 for details

OUT NOW! 811 IDEAS FOR YOUR COMPUTER

NEW
SAME-DAY
DELIVERY
IDEAS
BOOK

In the Inmac catalogue of ideas for your computer check to see what is in the latest issue for you:

Cables, cables and more cables! How to order custom-built cables. When to use screened cables. How to choose the right EIA RS-232 extension cables for your VDU's and how to connect your Apple, Commodore, or other micros to Qume, Diablo, NEC printers. Compatible cables for connecting new peripherals to your DEC, Data General, Hewlett Packard, IBM, Osborne and Tandy computers.

Lifetime Floppies Read about Inmac Plus — the floppy with a lifetime guarantee! Choose from our range of 100% error-free disk cartridges, flag-free disk packs,

each with a 3-year replacement guarantee.

New Ideas! Dozens of exciting new products — many never seen in Europe before now — and lots of helpful hints on getting more from your computer department.

Service and Quality — a promise you can rely on! We promise a next day delivery service of our products, a 30-day risk-FREE trial, and a 12-month trouble-free quality replacement guarantee.

Send today for your FREE catalogue with no obligation to purchase — but be warned: you will want to buy once you have read the Inmac catalogue ideas book!



FREE! IF YOU USE A COMPUTER
☎ 09285-67551/01 740 9450

Send this coupon to
Dept.716, Inmac (UK) Ltd., Davy Road,
Astmoor, Runcorn, Cheshire WA7 1QF.

Name _____
Company _____
Title _____
Address _____
Postcode _____ Tel. _____
Computer System _____

24 hour tel. no.
☎ 09285-67551



"THE BEST AND FASTEST SERVICE ON THE SOFTWARE MARKET"

(B. Strasser, Jordan)

CONFUSED by the growing choice of BBC programs? We can help. We've played hundreds to choose the best (like the ones on this page.) Details in our catalogue - free with your order. It's the only catalogue to give details of the best, omit the rest and quote all the reviews. All programs work with keyboard control or joystick as shown. All programs FOR 32K BBC.

WE TRY TO SEND YOUR PROGRAMS THE SAME DAY WE GET YOUR ORDER. Access/Visa card holders phone 01-789 8546, 24hrs, from any country where your own laws allow this. All games in stock - and tested by us - BEFORE we advertise them! Try us and see ...

Of course, we have the classics like THE HOBBIT (text only) £14.95 and PIMANIA (win £6,000!) £10.00 and the 747 FLIGHT SIMULATOR ("the best") £8.95. But we also have, among others ...

SPITFIRE A new flight simulator with two differences: first, the controls are different because the plane is old; second, you can learn aerobatics - not just flying! Your instrument panel is copied from the Mark XIV Spitfire. 20 control keys and the cursors for your joystick. Clear, big instruments. Learn turning, banking, stalling, spinning, looping - and landing before the fuel runs out. Very convincing engine noise varies with your engine speed! Needs skill and concentration. NO STIX. (Alligato) £7.95

BLAGGER Brand-new 20 SCREEN fully animated graphic game. (It's quite a lot like M*N*C M*N*R, actually.) Beautiful graphics, the screen is alive with movement as you try to collect keys to the safes. Each of the 20 screens is a different puzzle, with a different solution. Will your burglar make it? You'll certainly make him try for weeks! NO STIX. (Alligato) £7.95

PETTIGREW'S DIARY Intriguing new 3-part graphic + text adventure. Each chapter loads separately and you must finish each to reach the next! Can you unravel the secrets of the diary in the **Burning Farmhouse** (what must you rescue? How?) in **London Frolics** (realtime text adventure; collect information, not objects) and in **European Trek** (8 separate challenges). The most challenging adventure we've met recently - and varied enough to keep you interested. NO STIX. (Shards) £7.95

GORF For children of all ages, the bargain of the year! Four arcade games linked together on one tape for one price! - and with very pretty, fast-moving graphics (+ Hall of Fame). Fight your way through SPACE INVADERS, LASER ATTACK, FIREBIRD and MOTHERSHIP. It's very hard to get bored - or to remember the right technique for each game! STIX OK. (Dr SOFT) £7.95

FORTRESS Too new for reviews, this 'ZAXXON' - type game works beautifully on your Beeb. As Pace say ... the Fortress awaits you! It is a classic computer game, in a smashing 3D graphic form. All the features you would expect, plus a Hall of Fame. Fast and furious. STIX OK. (Pace) £8.95

POOL A very realistic simulation in this game for two players. (With very good Scott Japlin music, too!) You can play solo to perfect your technique. Excellent and smooth hi-res colour graphics make the full-screen table a pleasure to play on. You control the cue angle and strength of shot and can get it down to a fine art. Choose the frames to play, too. Great display: very satisfying program. NO STIX. (Dynobyte) £7.95

LORDS OF TIME "Some of the most intriguing puzzles I've come across ... not to be missed". (Home CampWkly) "Executed with wonderful style ... highly recommended". (PapCampWkly) In this text-puzzle adventure you must collect 9 objects, each marked with an hourglass, from different timezones - from the Ice Age to the Space Age. 200+ locations, 750 messages, 80 objects, vocabulary over 200 words. Beautifully written and more sophisticated than ever. NO STIX. (Level 9) £9.90

PINBALL ARCADE "As professional a piece of software as you are likely to find ... the graphics are exceptionally good". (C&V Games) **DESIGN YOUR OWN PINBALL TABLE!** One example is included, but the fun is designing, playing and saving your own. You can add or take away or move 38 different features - springs, wires, flashing lights, bumpers. Alter their scores, their bounce. Alter the flippers, even tilt the table. Change just about everything, quickly and easily. Then play with the results. Be your own Pinball Wizard. NO STIX. (Kansas) £9.90

BIRDIE BARRAGE "Very little to fault ... well presented, and as accurate as you're going to get". (PersCampNews) The best golf game we've seen for the Beeb. Acorn Park Golf Course has 18 holes, 72 par. You have a full bag of clubs and full screen graphics to play with. Set direction and power of each shot very accurately - and watch your ball in flight. Special detailed display when you reach the green. Wind strength, direction, changes between holes. NO STIX. (Computosalve) £7.95

TWIN KINGDOM VALLEY "Sure to become a classic ... an involved and difficult adventure ... the excellent graphics add to the enjoyment". (MicroAdventurer) Not only a great adventure, but all 175 locations are drawn in hi-res graphics - and some of the beautiful drawings contain clues. 36 commands: realtime adventure with 6 control options. Rapidly becoming OUR BEST-SELLER! NO STIX. (Bug-Byte) £9.50

CYLON ATTACK "Stands head and shoulders above the rest" (Acorn User) "Excellent ... the standard by which other games will be judged" (Micro User). "A superb program with excellent graphics" (CampChoice) You will really believe you are launching from and docking with a mother ship: you will see and feel you are refuelling; you will know exactly when you can kill the enemy. UNIQUE 50 PLACE HI-SCORE TABLE CAN BE SAVED. Great. And 3D, of course. STIX OK. (A & F) £7.90

TRENCH "It's very hard even at skill level one ... a challenge to your skills" (A&B Camp) "Manna from heaven" (PersCampNews). One of the most exciting games we've ever played. Fly your Beeb X-wing Fighter down the 3D Trench towards the Death Star-style target, dodging the tie-fighters as they attack. 9 skill levels: sensational graphics: one of our best sellers. STIX OK. (Virgin) £7.95

SPRING SUPER SAVERS!

All of these programs have starred in our BBC catalogues

THE HOBBIT (Melbourne)	NOW £11.95	SAVE £3.00
DOGFIGHT (Opus)	NOW £ 7.95	SAVE £2.00
MATHS INVADERS	NOW £ 5.95	SAVE £2.00
CYBERTRON MISSION (P.Power)	NOW £ 6.45	SAVE £1.50
ALIEN INTRUDER (Superior)	NOW £ 5.95	SAVE £2.00
DANGER UXB (P.Power)	NOW £ 5.95	SAVE £2.00
FELIX IN THE FACTORY (P.Power)	NOW £ 5.95	SAVE £2.00
LUNAR RESCUE (Alligato)	NOW £ 5.95	SAVE £2.00
MICROBE (Virgin)	NOW £ 5.95	SAVE £2.00
ROAD RUNNER (Superior)	NOW £ 5.95	SAVE £2.00

ONE PROGRAM FREE!

If your order from this ad comes to £25 or more excluding p & p, tell us which of the above 10 games you would like - absolutely free! (Outside UK, please add appropriate p & p for your free game.)

To: SOFTWARE SUPERMARKET, 57 Howards Lane London SW15 6NU.

If you do not want to cut this magazine, write your order out carefully on plain paper and quote this number ACU 2

I own a 32K BBC computer. I enclose a cheque/PO made payable to Software Supermarket OR Charge my VISA/ACCESS/EUROCARD/MASTERCARD number

<input type="text"/>	<input type="text"/>	<input type="text"/>	<input type="text"/>	<input type="text"/>	<input type="text"/>	<input type="text"/>	<input type="text"/>	<input type="text"/>	<input type="text"/>
----------------------	----------------------	----------------------	----------------------	----------------------	----------------------	----------------------	----------------------	----------------------	----------------------

Signature

Please write clearly. If we can't read it, you won't get it.

Name

Address

Postcode

Phone, if any, in case of query

PROGRAM NAME	Price
	£
	£
	£
	£
	£
	£
	£
	£
	£
POSTAGE AND PACKING	U.K. Add 55p only per order. £0.55p
	EUROPE. Add 55p for each program. £
	OUTSIDE EUROPE. Add £1 for each program airmail. £
	OUTSIDE EUROPE. ADD £1 TO TOTAL FOR REGISTERED MAIL. TOTAL £

SOFTWARE SUPERMARKET
VISA/ACCESS: CALL 01-789 8546 (24 hrs)

BBC SPEECH

PRICE BREAKTHROUGH

Speech Synthesizer For The BBC Computer

Totally unlimited vocabulary is now possible with the revolutionary "SWEET TALKER" Speech Synthesizer for the B.B.C. A or B Microcomputer, any series.

The CHEETAH "SWEET TALKER" simply plugs into speech socket IC99 within the computer.

No soldering, no cutting of tracks, no headaches.

Based on an allophone system you can easily program any word, sentence or phrase and incorporate speech into your software games.

Fully tested and guaranteed.

Complete with demonstration cassette and full instructions.

Price includes V.A.T., Postage and Packing.

Delivery normally 14 days.

Export orders at no extra cost.

Dealer enquiries welcome.

Send cheque/PO now to:-

CHEETAH MARKETING LIMITED

Dept. AU3, 24 Ray Street, London EC1. Tel: 01 833 4909

Cheetah, products available from

branches of **John Menzies** *Boots* **WHSMITH**  and **Rumbelows**



SOFT POTTERY

Malcolm Banthorpe, who brought graphics to life in earlier issues, now sets them spinning about an axis

67

THE graphics featured in my previous articles on 'Life' and 'Adding a new dimension to Life' (January and March 1984 issues) were largely confined to plotting cubes, each cube being displayed as the three surfaces assumed by the program to be facing the viewpoint. This assumption, coupled with the order in which the cubes were plotted, made it possible to implement a simple form of hidden surface removal without getting involved in mathematical calculation. I also showed how cubes can be used as building blocks for more elaborate 3D structures by using them as components of three-dimensional lettering.

At the heart of the programs was a procedure called PROCplot, which took four arguments and performed the perspective projection of 3D co-ordinates. The procedure, with one important difference, is central to the two programs in this article. To recapitulate on its use, a call to the procedure takes the form:

PROCplot (K, X, Y, Z)

where K is similar to the first argument of a Basic PLOT command and determines whether the action will be a move, a solid or dotted line or a filled triangle. The remaining three arguments correspond to X, Y and Z co-ordinates. The procedure as given previously also contained limited provision to rotate a point around the origin of the X and Y axes.

The difference in the new version is that its action is limited to perspective projection and three new procedures are

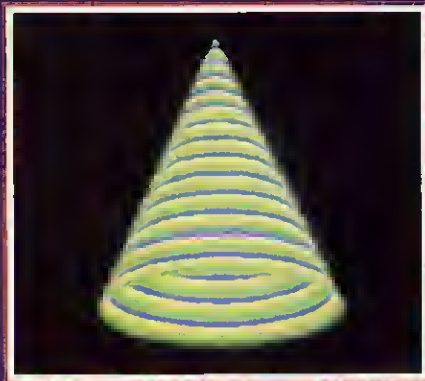

A cone...

defined to give independent rotation around the X, Y and Z axes. This offers more flexibility in the way that shapes can be manipulated.

Armed with the general-purpose PROCplot, it is possible to draw a wire-frame representation of just about any shape, provided you are able to specify the co-ordinates of all the vertices in the form of data statements. Therein lies a possible snag. Anyone who has tried compiling such a set of co-ordinates would probably testify that it can be tedious to work out in advance all the vertices of anything but the simplest of three dimensional shapes.

The shapes featured here neatly sidestep the hard work by having their co-ordinates entirely defined as well as plotted by the computer. All the shapes are the result of rotating a two-dimensional profile around a vertical axis. As it is possible to rotate the shapes themselves, the axis of rotation does not have to appear vertical on the display. Some of the results can have the appearance of vases and other 'thrown' pottery – hence the title. Both programs are software versions of a potter's wheel – and you don't get your hands dirty.

By rotating a single vertical line around a vertical axis we can get some suggestion of the outline of a cylinder (figures 1 and 2). Figure 2 consists of the ten images of the line that results from rotating it through one complete revolution in 36 degree steps. So far it doesn't look very promising as there is not enough depth

information to make it clear that these ten lines represent a cylinder.

A considerable improvement is gained by linking the lines with a series of horizontal rings (figure 3). The surface of the cylinder is now broken down into a series of facets and begins to look more like a normal wire-frame representation. As with all such images there is some ambiguity and there is nothing like a real curve, only straight-line approximations. This version succeeds to some extent because the perspective effect of making the nearer facets appear larger than those on the rear surface helps interpretation of the two-dimensional image as having depth.

The program of listing 1 (yellow page v) draws this cylinder and other wire-frame solids which can be described by rotating a profile. PROCrotateX, PROCrotateY



A gourd...

and PROCrotateZ allow the rotation of any co-ordinates around the X, Y and Z axes respectively. A procedure call takes the form:

PROCrotateX (X, Y, Z, A)

which will rotate the point X, Y, Z by A degrees around the X axis. The rotated co-ordinates are returned in the variables x%, y% and z%. The other two procedures operate similarly and also return the co-ordinates in x%, y% and z%. While PROCrotateY is used to generate the shape's outline, PROCrotateX and PROCrotateY can be used to rotate the whole shape.

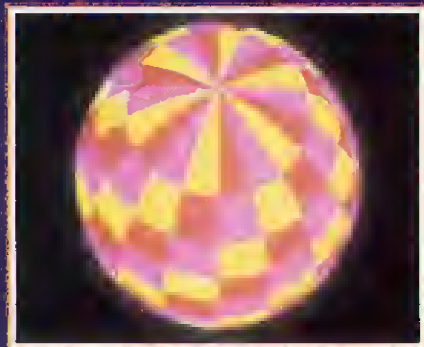

A sphere...

The program starts by asking for a function describing the profile to be typed in. To draw a cylinder, simply enter any number corresponding to its radius. Something in the order of 400 or 500 is a suitable value. Next, the program asks for rotation (in degrees) around the X and Z axes. To save processing time,

PROC rotate X and PROC rotate Z are not called if rotation angles of zero have been entered. To plot an un-rotated shape simply press RETURN when these angles are requested. Figure 4 shows six views of the cylinder obtained by entering various combinations of angles.

To change the overall shape we need to modulate the rotated line. The simplest variation is probably to make the line slope towards the axis of rotation. This can be achieved by entering the functions:

$$50*(10 - V\%)$$

(V% is the variable used by the program to hold the vertical step number. There are ten vertical and ten rotational steps.)

The result is the cone of figure 5. Both angles of rotation are zero in this illustration but the cone can be moved around, as the cylinder was, to give the effect of a changing viewpoint.

The profile to be rotated is initially stored by the program in the array called Profile%

If the function to be plotted is now entered as:

$$SQR(500 - 2 - (500 - V\% * 100) - 2)$$

a crude version of a sphere is drawn (figure 6). This is not particularly satisfactory as a representation because the facets are too large to allow more than a rough approximation of a curved surface.

Other variations in the shape are possible by substituting functions for more complex profiles (figures 7 and 8). The function used here was:

$$300 + 220 * SIN(1 + V\% / 2)$$

in figure 8 it has been tipped forwards by entering an X rotation of -60 degrees. The possibilities for generating new rotated shapes are limited only by your patience to enter expressions and wait to see what appears on the screen. Bearing in mind that V% varies in value from 0 at the base to 10 at the top of the shape, the maximum absolute value of any function

you enter should not exceed 600, otherwise part of the plotting will be off the screen.

If you can't think of any different functions, try changing the numbers in the examples given so far, or even substituting RND functions.

In general, sine and cosine functions lend themselves well to curves of this kind but just about anything you can think of is worth a try - but make sure the syntax of the function you enter is valid, otherwise, although initially accepted by the program, a

range of rotations of the shapes but it is much simpler than other methods of hidden surface removal.

The exact degree of rotation possible will be different for each function plotted as it depends to some extent on the nature of the shape. A certain amount of experiment will be needed to give you some idea of what is possible. It is always safe to start with an upright shape (X and Z rotations of zero).

Listing 2 again starts by asking for the function to be plotted. As mentioned, plotting takes considerably longer, even to reach a stage which gives a reasonable idea of the final shape. To save wasting time on plotting unpromising shapes, the program next draws the profile as a single line and asks whether you want to continue. The vertical axis of rotation is also shown as a dotted line. The plot may therefore be abandoned at this stage and another function entered.

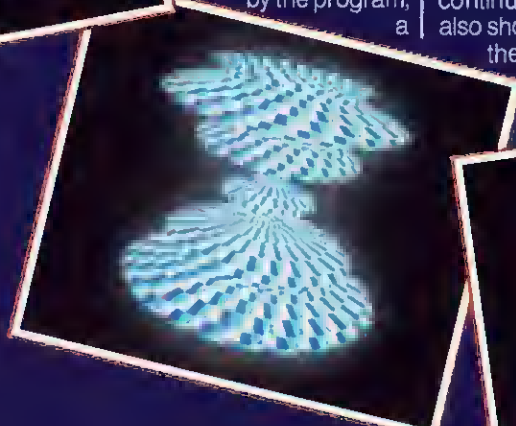
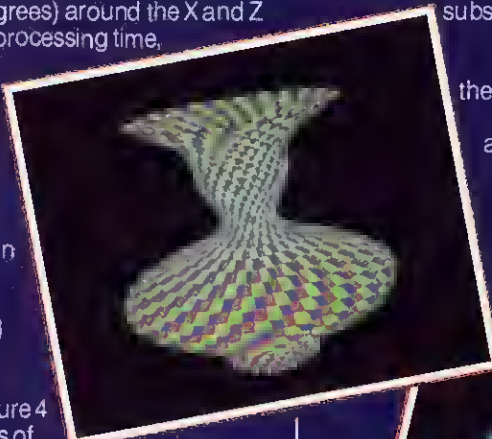

'Syntax error in line 120' or 'No such variable in line 120' message will be generated when it comes to evaluating the expression.

A couple more suggestions to try in this program are:

$$100*(5 - V\%)$$

and

$$300 * COS(1.5 * V\% * PI / 10)$$

There are two main ways in which the appearance of these shapes can be improved, both incorporated in listing 2. First, to improve the smoothness of the curves, the number of facets is increased by quadrupling the number of vertical steps and increasing the number of rotational steps from 10 to 72. This increases the number of facets from 100 to 2880 and inevitably the time required to plot them all. Second, to remove much of the ambiguity in the image, a simple form of hidden surface removal is employed. Each facet is drawn as a filled quadrilateral rather than just an outline.

The idea behind this is similar to that used on the cubes in the previous article. Facets are drawn starting with those that are assumed to be furthest from the viewpoint so that they will subsequently be erased by any facets plotted later, which theoretically lie between them and the viewpoint. This will work for only a limited

A suitable function to try first would be:

$$300 + 220 * SIN(1 + V\% / 8)$$

If each of the facets was simply plotted as a uniformly filled quadrilateral then they would all merge together visually, for the edges of the facets would not be visible. The result would be a flat shape with the 3D effect lost. One solution would be to plot the edges in a different colour to give a surface grid effect not unlike the wire frames of the first program. An alternative, incorporated in this program, is to plot adjacent facets in different colours and thus give the shape a surface pattern.

The colour can be determined by a second function of the vertical and/or rotational steps. The function chosen should return a range of values from 1 to 3 as plotting is done in mode 1 and there are three logical foreground colours available. The background is logical colour 0, black unless otherwise defined. The program therefore next asks for a function to determine the surface pattern. A suitable function to try is:

$$1 + V\% MOD 3$$

which will give a series of horizontal stripes. The variable V% again holds the vertical step number from 0 to 40, while H% holds the rotational position and is incremented in steps of five from 0 to 180. The shape is drawn in two halves and a variable S%, which has the value of either -1 or 1 depending on whether the right or left half of the shape is being plotted, may also be included in the pattern function. The colours displayed can, of course, be varied by means of the VDU19... statement in line 270.

In most other respects the second program behaves like the first, and most of the same shape functions can be used if they are modified to take account of the increased number of vertical steps. The cone function becomes:

$$12 * (40 - V\%)$$

and the sphere function becomes:

$$\text{SOR}(500 \ 2 - (500 - 25 * V\%) \ 2).$$

Again, the variety of shapes that can be plotted is limited only by your willingness to try out different functions. The hidden-surface effect will not work if the profile crosses the axis of rotation, though the result may still be interesting. In other words, the preliminary profile drawn by the program should not cross the dotted line and should remain to the right of it if



'The exact degree of rotation possible will be different for each function plotted as it depends on the nature of the shape. Some experimentation will be needed'

69

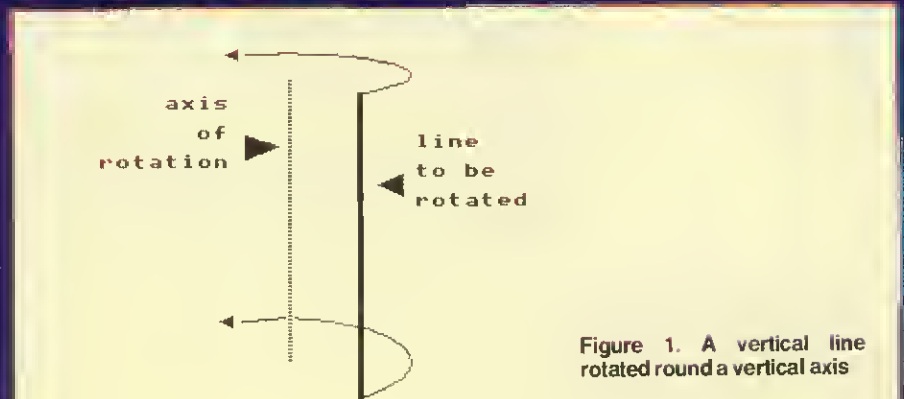
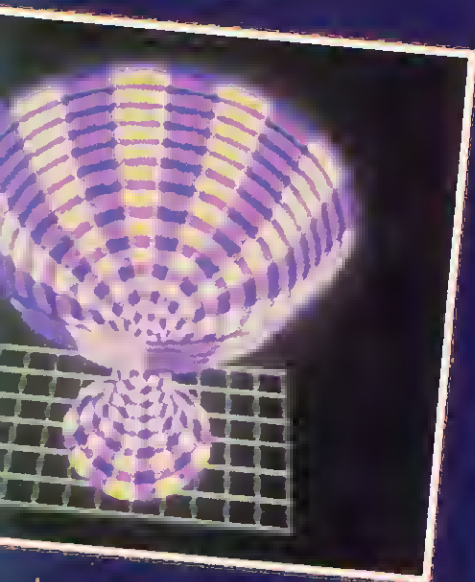

Figure 1. A vertical line rotated round a vertical axis

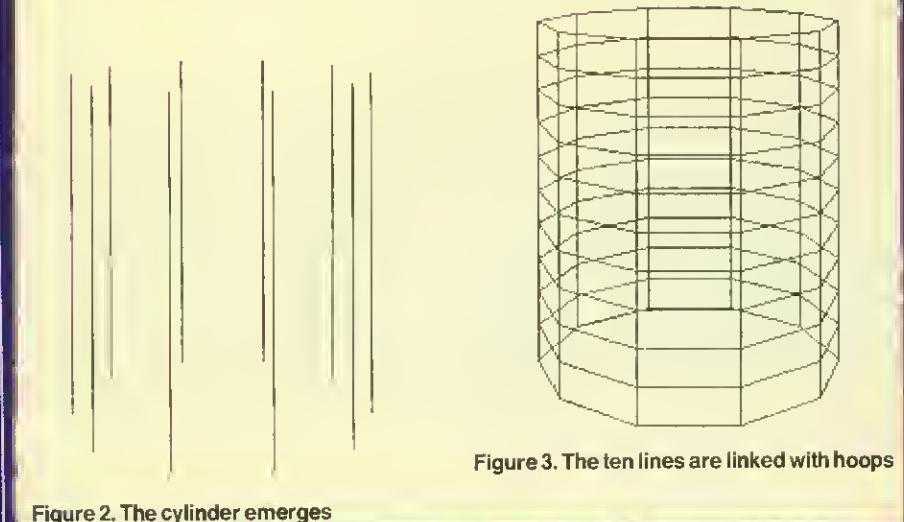

Figure 2. The cylinder emerges

Figure 3. The ten lines are linked with hoops

... These are the possibilities of an outline rotating round an X axis. Above and left is a single shape at two different angles of rotation in which the hidden surface effect is maintained. A regular grid has been added as a base.

you want a realistic-looking display. You may find it interesting to try writing a procedure using PROCplot and the rotation procedures to draw a grid for your vessel to stand on. The lower edge of all the shapes is centred at co-ordinates 0, -500.0.

Here are some more functions to try.

Profiles

$$300 + 220 * \text{COS} \\ (V\%/5 * .5) - 100 * \text{SIN}(V\% * .375) \\ 300 + 250 * \text{COS}((40 - V\%)/8.8) - 25 \\ * \text{SIN}((40 - V\%) * .375)$$

Patterns

$$1 + (((H\% * S\% + 180 + (S\% = 1)) \text{DIV} \\ 20 + V\% \text{DIV} 4)) \text{MOD} 3 \\ 2 + (H\% \text{DIV} 5 - (S\% = 1)) \text{MOD} 2 \\ 1 + ((H\% * S\% + 180) \text{DIV} 5 + V\% + \\ (S\% = 1)) \text{MOD} 3$$

PROCplot, PROCrotateX, PROCrotateY and PROCrotateZ constitute a suitable starting point for a wide variety of 3D plotting tasks. I hope these and the illustrations on these pages give readers otherwise deterred by the mathematical treatment of the subject in many textbooks the tools and the inspiration to develop their own ideas.

See page 71 for the remainder of the wireframe figures developed in the text of this article.

SPECIAL OFFER!
Deduct £1 per cassette when ordering 2 or more.

TOP QUALITY SOFTWARE FOR THE RCORN ELECTRON

RCORN ELECTRON



CENTIBUG £7.95
The centibug descends from the top of the screen weaving intimidatingly between the mushrooms. Your objective is to shoot all the segments of the centibug before it reaches the bottom of the screen. Features include: spiders, snails, flies, 6 skill levels, hi-score, rankings, and increasing difficulty.



ALIEN DROPOUT £7.95
A novel and unusual program. Arcade-action with this exciting multi-stage shooting game. The objective of the game is to shoot the aliens out of their "boxes" before the "boxes" fill up. Once full, the aliens fly down relentlessly, exploding as they hit the ground. The game features include: 6 skill levels, rankings, hi-score, increasing difficulty.

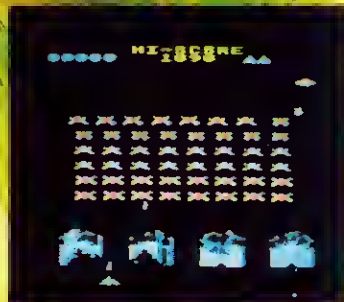

INVADERS
48 marching Invaders drop bombs that slowly erode your defences, and two types of spaceship (normal and double speed) fly over releasing large bombs that penetrate through your defences. Increasing difficulty, hi-score, rankings, superb graphics and sound.



WORLD GEOGRAPHY £7.95
This program covers 166 countries which are divided into 8 categories of difficulty. Each country is pinpointed on an accurate hi-resolution screen map of the world, and the user is asked the capital and/or population. At the end of the test, the percentage of correct answers is given, so that the student can easily monitor his increasing geographical knowledge.



FRUIT MACHINE £7.95
Probably the best fruit machine implementation on the market. This program has it all... HOLD, NUDGE, GAMBLE, spinning reels, realistic fruits and sound effects, multiple winning lines. This is THE fruit machine program to buy.



CONSTELLATION £7.95
This fascinating program enables the user to "view the stars" from any point on the Earth's surface, on any date and at any time. A total of 455 stars in 50 constellations may be viewed, and the "telescope" may be moved up, down, left or right, zoomed in or zoomed out. The stars can be displayed by magnitude or constellation.

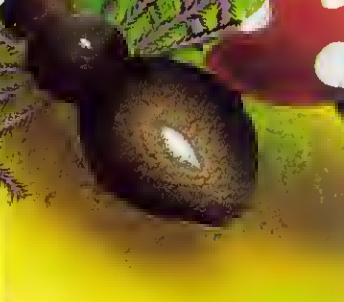

DISASSEMBLER £7.95
A relocatable disassembler which, unlike some similar programs, allows the disassembled source code to be output to memory. It may then be modified and re-assembled. Other features: page-mode option, output to printer if required, output of ASCII symbols if required.

WE PAY UP TO 20% ROYALTIES FOR HIGH QUALITY BBC MICRO AND ELECTRON PROGRAMS



SOFTWARE SYSTEMS LTD
100, 101, 102, 103
JAMES STREET, LONDON, E1 8JL

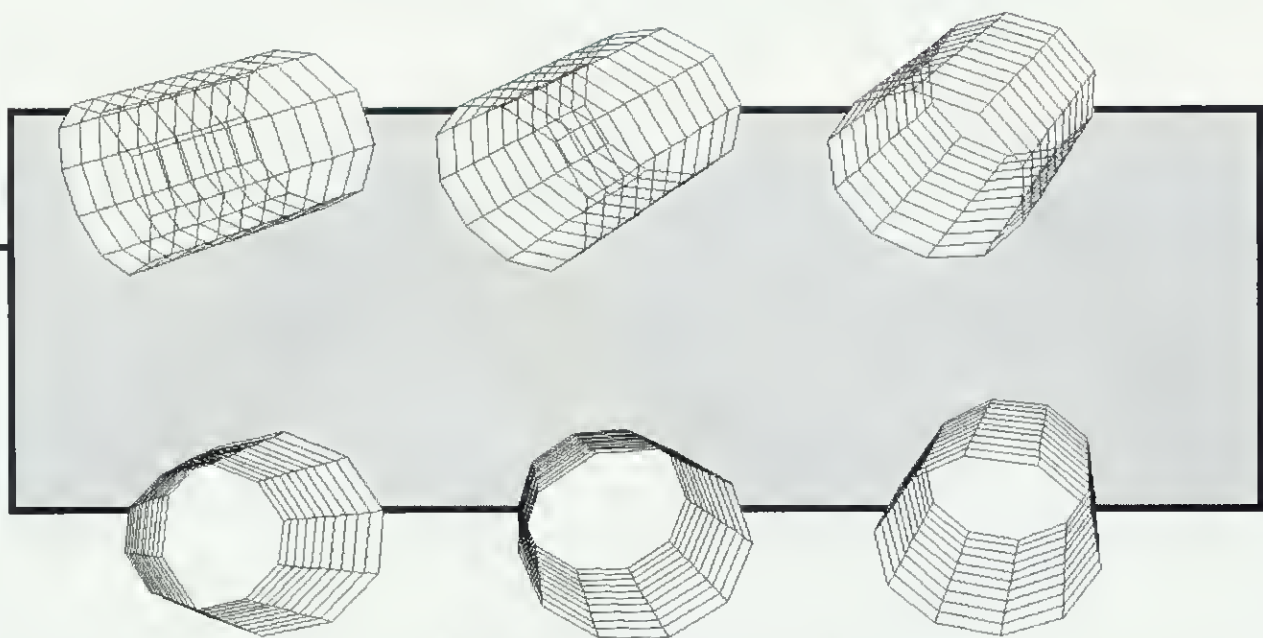

Figure 4. Views of the cylinder from six angles

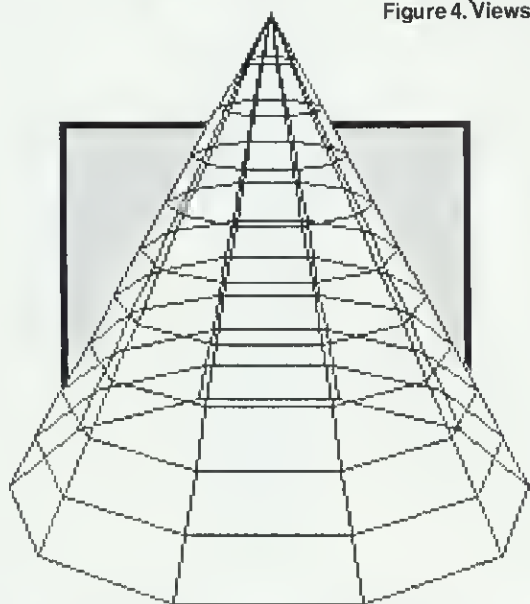

Figure 5. The 'vertical' line slopes, producing a cone as it rotates

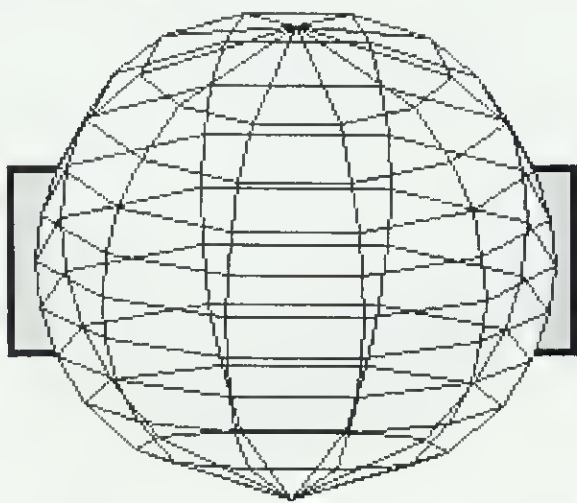

Figure 6. A faceted sphere

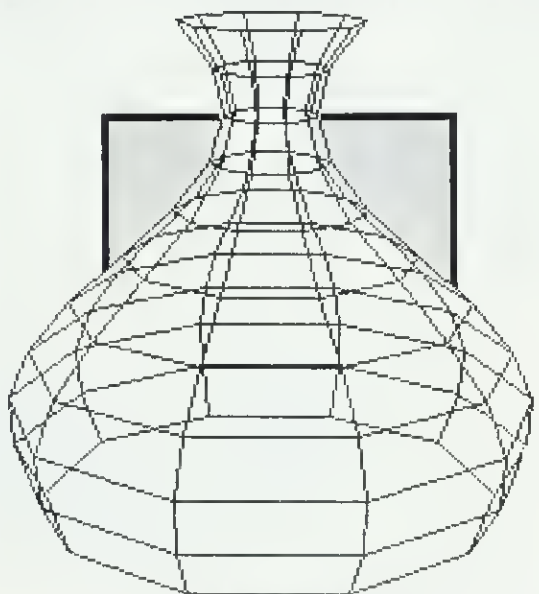

Figure 7. The sphere developed

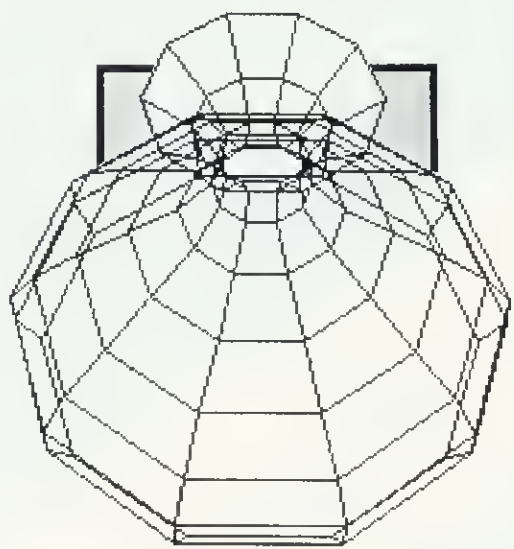

Figure 8. Another sphere variation, rotated

We've just won an award for blowing

**SEE MICRONET AT YOUR
LOCAL JOHN LEWIS STORE!**

way the cobwebs.

You know the story, the Micro you thought would give endless hours of fun soon becomes a five minute wonder. You get bored and dump it on the shelf to gather dust.

With the introduction of Micronet 800 you now have access to a vast mouth-watering menu of facts, figures and fun.

If we said it was a major breakthrough in microcomputer technology we wouldn't be going over the top.



Just recently at the Which Computer Show we picked up the prestigious RITA award for Systems Innovation of the Year.

RITA is the 'Oscar' of the computer industry. Judged and sponsored by the major forces in related institutes, associations and publications.

Incredibly all it costs is just a pound a week to take up a subscription to the Micronet system. Plus, for most of you, a local telephone call whenever you want to connect up.

Then you've got 30,000 pages at your fingertips, including Computer News Flashes, all that Prestel has to offer, and Micronet's SwapShop. Where you can buy anything from joysticks to second-hand computers.

Interact with our daily news update. You can even take over the world; competing against hundreds of other subscribers on the system, in our 'Stamet' game.

If we haven't won you over with that then try downloading our wide selection of free games and other tele-software.

Naturally, you can run household accounts, manage businesses, talk to other subscribers nationwide using the system.

The list is endless and so is the fun.

The only addition you need to connect with Micronet 800 is a modem unit.

Apart from that all you'll want is a pen to fill in the coupon for more information. Then we'll have you linked up in no time.

Before the dust settles, in fact.

Please send me the full facts about Micronet 800.

Name _____

Make/Model of Micro _____

Address _____

Telephone _____

MICRONET 800, Scriptor Court, 155 Farringdon Road, London EC1R 3AD. Telephone 01-278 3143.

• Circle No. 129
AUB

micronet
800

WHAT RESOLUTION FOR ONLY £230. (EX.VAT)

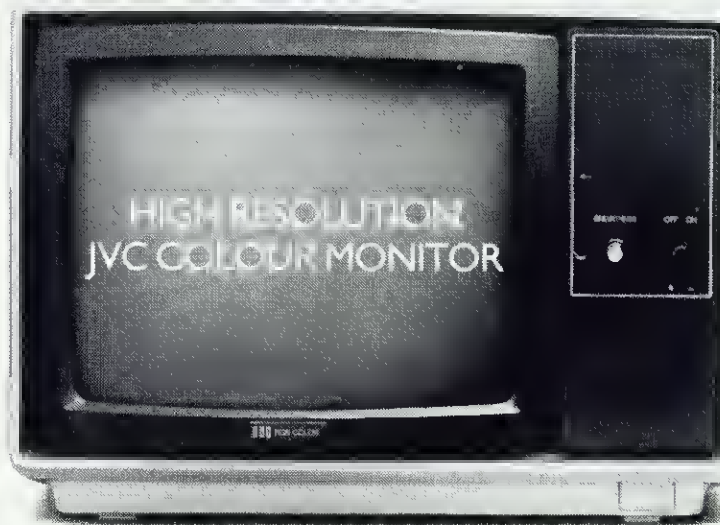

Our RGB high resolution colour monitors (580 x 470 pixels) sell for £229.95 (excluding VAT)—a saving of over £100 compared to other leading monitors of similar specifications.

That's a bargain we guarantee you won't see from any other micro retailer.

We've managed to acquire the sole distribution rights enabling us to offer these superb monitors at this unbeatable price.

And just because you're saving on price doesn't mean you're sacrificing quality. Here's what Personal Computer News had to say about our monitors.

"There is no doubt that the JVC range of ECM colour monitors is excellent value for money... there is no loss in quality of picture after long periods... remember as more and more resolution is available with new micros, the need for a better display will be that much greater."

For those who only require medium resolution we also have a model (370 x 470 pixels) at £179.95 (excluding VAT) which is equally excellent value for money.

Both units have a 14" screen and are suitable for the BBC Micro, Sinclair QL, Lynx, Oric, Apple, IBM, the

Electron and most other leading micros.

And naturally there's a years full guarantee.

Another one of our commitments is to make certain we deliver your monitor by courier within ten days of receiving your order.

You can order by filling in the coupon below and posting to: Opus Supplies Ltd., 158 Camberwell Road, London SE5 0EE. Or by telephoning 01-701 8668 quoting your credit card number. Or, of course, you can buy at our showroom between 9.00-6.00pm, Monday-Friday 9.00-1.30pm, Saturday.

MODEL REFERENCE	1302.2 High Resolution	1302.1 Medium Resolution
RESOLUTION	580 x 470 Pixels	370 x 470 Pixels
C.R.T.	14"	14"
SUPPLY	220/240v. 50/60Hz.	220/240v. 50/60Hz.
E.H.T.	Minimum 19.5kv Maximum 22.5kv	Minimum 19.5kv Maximum 22.5kv
VIDEO BAND WIDTH	10MHz.	6MHz.
DISPLAY	80 characters by 25 lines	80 characters by 25 lines
SLOT PITCH	0.41mm	0.63mm
INPUT: VIDEO	R.G.B. Analogue/ TTL Input	R.G.B. Analogue/ TTL Input
SYNC	Separate Sync on R.G.B. Positive or Negative	Separate Sync on R.G.B. Positive or Negative
EXTERNAL CONTROLS	On/off switch and brightness control	On/off switch and brightness control

To: Opus Supplies Ltd., 158 Camberwell Road, London SE5 0EE.
Please send me:

- _____ High Resolution Colour Monitor(s) at
£229.95 each (ex. VAT).
- _____ Medium Resolution Colour Monitor(s) at
£179.95 each (ex. VAT).
- _____ Connection lead(s) at £6.00 each.

I understand carriage per monitor will cost an extra £7.00.
(N.B. A High Resolution Monitor including VAT, lead, and carriage costs £279.39. A Medium Resolution Monitor including VAT, lead and carriage costs £221.89).

I enclose a cheque for £ _____ Or please debit my credit card
account with the amount of £ _____ My Access/Barclaycard
(please tick) no. is _____

Please state the make of your computer _____

Name _____

Address _____

Telephone: _____

Opus.
Opus Supplies Ltd.

AQ16

ACORN USER SOFTWARE

FOR THE BBC MICRO AND ELECTRON
ON DISC AND CASSETTE

Two quality, full colour games to test your skill,
nerve and cunning.

Each £7.95 per cassette or £10.95 per disc (40/80 track).

Price includes VAT and postage.

Both games need OS1.0, or later, and 32k.



SWORD MASTER is one of the few two-player games around, and is designed for joystick or keyboard.

Sword Master by Ken Worrall is based on the fencing rules written in 1190 by Herman von Salza for the Deutscher Order of Teutonic Knights. It features full-colour machine code animation of a sword duel between the players shown on screen as knights.

Full instructions, music, sound effects, player rankings (from Greenhorn to Swordmaster) and a roll of honour (which can be saved) are all included. The game also closely reflects the rules, style and dress of the Deutscher Order.



Trek was the first game to take advantage of voice synthesis on the BBC micro – and uses joystick or keyboard.

Trek puts you in charge of a Starship with the task of wiping out an alien fleet. It's an excellent adaptation of the classic game with 7 screen displays, 3 on-board computers and 2 weapon systems.

Versions have been written for BBC micro and Electron to use both machines to their full. The BBC tape uses voice synthesis (if the chips are fitted).

The game has been extensively developed from Tim Heaton's famous Trek III. It barely fits into 32k.

DISC UPGRADE SERVICE

Return your cassette of Trek or Swordmaster, and we will exchange it for a disc (which will run on 40 or 80-track drives) for just £3.50. Please specify Amcom, Wattord or Acorn DFS.

PLUS

ARTICLE LISTINGS ON CASSETTE

Yes, at last, the tape you've been crying out for! Save the wear on your fingers by sending for one of our cassettes giving all the major listings in this issue.

Each cassette costs £3.75 (inclusive) for the Electron and BBC micro. This includes a menu and disc transfer routine to help you find your way around – and use on your own programs.

The tapes come with BBC programs on one side and Electron programs as the other, so it shouldn't be possible to mix the two.

Just turn to our pull-out card opposite page 128 to order.

75



Save yourself the time and bother of typing in Acorn User listings

TURN TO PULL-OUT CARD TO ORDER

SOFTWARE INVASION...

Let excitement invade your home computer!
Travel to Alpha Centauri. Enter the Vortex.
Command the ground missiles, or join the
shoot-out at the O.K. Corral!



GUNSMOKE

...the movement of the saloon-bar door was all the warning he needed! At the speed of light his hand moved toward his holster, while a sixth sense warned him of the upper floor window... 3D ACTION, SOUND EFFECTS, BEAUTIFUL GRAPHICS BBC MODEL B £7.95 CASSETTE £11.95 DISK



3D BOMB ALLEY

... the continued thunder of the hissing ground missiles had long now daefened him - unless he hed some of those bambers down, the float, in the small stretch of water was e sitting duck... 3D ACTION, SOUND EFFECTS, BEAUTIFUL GRAPHICS BBC MODEL B £7.95 CASSETTE £11.95 DISK



ATTACK ON ALPHA CENTAURI

... he punched the key, and the control monitor filled with the picture of bug-eyed wasps attacking from their volcanic nest; decisively he dived to the left and his laser gun burst into action... 3D ACTION, EXPLSIVE SOUND EFFECTS BBC MODEL B £7.95 CASSETTE £11.95 DISK

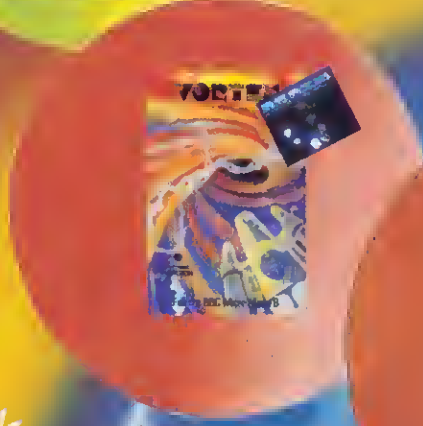

VORTEX

... there was no escape, he had to enter the Vortex and bet on his skills! He grabbed the manual controls and with determination fired both upper deck guns... EXCELLENT SOUND KEYBOARD OR JOYSTICK, BBC MODEL B ALSO AVAILABLE ON ACORN ELECTRON CASSETTE FOR £7.95.

EAGLES WING

... he glanced at his fuel levels, a few more seconds of flying time. He hed to swing round through the burst of fire to reach the docking platform, he knew, in two minutes the game could be over... GRAPHICS, REALISTIC COMBAT, SUPERB CONDITIONS, BBC MODEL B, £7.95 CASSETTE, £11.95 DISK.

Spooks & Spiders

... perhaps, very slowly, he could reach the cellar... quietly he started climbing down, his foot slipped as the giant spider dived towards him... SOUND EFFECTS, EXCELLENT GRAPHICS BBC MODEL B, £7.95 CASSETTE, £11.95 DISK.

HOW TO ORDER: You may purchase any of the Games listed below most good BBC Software Stocks, W H Smiths, HMV or your nearest Spectrum Dealer. To order direct, fill in the coupon below with your requirements, make INVASION and post today. Please allow 7 to 14 days for delivery.
OVERSEAS ORDERS: Please add £10.00 per game ordered.

Do you write your own programmes? If you have an unusual programme which can meet our standards you could be earning more than £250 per week. Why not take advantage of our sought after reputation. Write now!

- Distributors, Multiple Store and Retailer Group inquiries invited.
- Available from WH Smith, HMV, all Spectrum shops and over 500 retail outlets in the U.K.

NEW!

NEW!

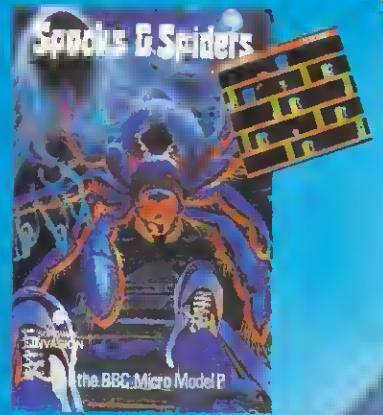

SOFTWARE INVASION

50 Elborough St., Southfields, London SW18 5DN.

Post to:
SOFTWARE INVASION 50 ELBOROUGH STREET SOUTHFIELDS LONDON SW18 5DN

GAMES	QNTY	TAPE	DISK	40 TRACK	80 TRACK	£
VORTEX						
VORTEX (Acorn Electron)						
ATTACK ON ALPHA CENTAURI						
3D BOMB ALLEY						
GUNSMOKE						
EAGLES WING						
SPOOKS & SPIDERS						

I enclose my Cheque/P.O. for £...

Name _____
Address _____

I am a Distributor/Multiple/Retailer/Dealer. Please contact me (please delete whichever not applicable).

BASIC INCREASE IN SPEED & SPACE

Time yourself as your technique improves, says Gary Smallridge

THE BBC Basic interpreter is fast in execution, but some Basic programs need to run really fast—for arcade games, sorting and searching, for example. An experienced programmer would probably use machine code for time-critical operations but the less adept programmer has to make do with the Basic interpreter.

The following guide is intended to help novice users of BBC Basic (and also Electron users) with writing programs. It is a collection of useful tips and experience gained in writing programs for the BBC machine and a Basic interpreter for a DEC VAX.

10 REM Program 1	>RUN	
20 B=2:C=3	A=5E-2	Time=574
30 D=100	>60 A = (B+C)/D	
40 T=TIME	>RUN	
50 FOR I=1 TO 1000	A=5E-2	Time=396
60 A = B/D + C/D	>30 D=0.01	
70 NEXT	>60 A = (B+C)*D	
80 PRINT "A=";A,"Time="	>RUN	
;TIME-T	A=5E-2	Time=379

Program 1.



Improving program speed

1. With expressions, remove common denominators. For example, consider the following Basic line:

```
A=B/100+C/100
```

Removing the division by 100 and placing outside the expression will improve speed, ie:

```
A=(B+C)/100
```

Try typing in program 1 and running it. Note the time taken and then type in this modification to line 60:

```
60 A=(B+C)/D
```

Notice that the running time taken this time is 31 per cent less than the previous time!

2. Multiplication is generally more efficient than using division. This can be demonstrated by typing in the following modifications to the program and running it:

```
30 D=0.01
60 A=(B+C)*D
```

The gain in speed isn't much this time—only 4%—but if points 1 and 2 were both adopted in the same program, the overall improvement would be as much as 33 per cent.

3. Avoid GOTOs wherever possible, otherwise the interpreter has to search through the whole program to find the destination line number. In contrast, with REPEAT...UNTIL or FOR...NEXT constructs, the interpreter 'remembers' where the start of the loop is.

4. FOR...NEXT loops are faster than REPEAT...UNTIL loops and REPEAT...UNTIL loops are faster than IF...THEN GOTO loops (see *User Guide*, page 194).

5. Using GOSUBs is faster than using PROCedures. Although this greatly reduces the readability of the program, it will speed it up. This is contrary to what the *User Guide* says on page 195 but can

DARK SCREEN

The Technology that puts NOVEX light years ahead



NOVEX

SCREEN GRAPHICS
COURTESY OF A B DESIGNS

Display Distribution, who market probably the most comprehensive range of professional monitors, announce an astounding leap forward in monitor technology.

The revolutionary NOVEX D/S monitor combines superb resolution graphics, colour balance and image clarity which moves existing monitor technology into the past. NOVEX advanced technology doesn't stop there; just push the unique green switch and instantly convert your monitor to a D/S green monochrome monitor for programming and word-processing applications.

NOVEX monitors (recommended for use with the BBC Micro and approved by the 'Test Bureau' for education) are specifically designed with both RGB and PAL inputs to cater for the majority of small computers. The durable metal case (in BBC Micro colours) houses an internal speaker with independent volume control, together with carrying handles for greater safety when moving the monitor around.

The complete range of NOVEX monitors is available through your local micro dealer, and backed by Display Distribution's after sales support. Dealer enquiries welcome by contacting Charles Martin on 01-891 3668.



DISPLAY DISTRIBUTION LTD.

35 Grosvenor Rd., Twickenham Middlesex. Telephone 01-891 1923/1513 Telex 295093

DISPLAY DISTRIBUTION.....

CARE OF EVERY DETAIL, RIGHT DOWN TO THE PRICE

£199-95

Excl. VAT & Carriage

```

10 REM Program 2
20 T=TIME
30 FOR I=1 TO 1000
40   PROCS
50   NEXT
60 PRINT "A="; A, "Time=";
   TIME-T
70 END
80
1000 A=A+1

1010 RETURN
1020
2000 DEF PROCS
2010 A=A+1
2020 ENDFROC
>RUN
A=1000   Time=249
>40 GOSUB1000
>RUN
A=1000   Time=229
    
```

Program 2.

easily be proved by typing in program 2 and running it, and then adding the following modification and running it:

```
40 GOSUB1000
```

The gain in speed is about 8 per cent.

6. When used as a subscript to index an array (for example, BOARD (I%)=0) an integer is faster, because the interpreter does not have to decode the integer number, unlike real numbers.

7. Long variable names are slow to interpret, short variable names are quicker – this includes integer, real and string variables and also procedure names. Although this again reduces readability, it improves running time. Also, don't start variables or procedure names with the same letter. Spreading them from A through to Z will make a difference. An ideal situation would be to develop the program using long variable names and then to use a utility to change globally the long names to unambiguous short ones, ensuring, of course, that they don't start with Basic keywords.

8. Putting lines of code on one line using the colon delimiter speeds run-time execution. This is because the interpreter does not have the additional overhead of decoding the line number. Try putting the whole of program 1 on one line and re-running it.

9. Spaces, blank lines, REMarks, etc, although aiding readability, are an additional overhead at run-time. Another useful utility for the serious programmer would be a program to remove redundant spaces, blank lines and REM statements from the source, producing a compacted, fast-running program. There are a number of ways this can be achieved. One is *Toolkit*, available from Beebug. A useful ROM as all that is needed is a single command (*PACK) and the utility removes all spaces, REMarks and blank lines and informs you just how much space you have saved. There have also

been a few machine code programs that do the same thing, but these have to be loaded into an area of memory not occupied by the program.

10. Put the most likely false condition first in IF statements when conditions are separated by the AND Boolean operator, and to the right of this the descending likelihood of being false. For example:

```
IF A=B AND C=D AND E=F THEN ...
```

If the condition 'E=F' is the most likely to be false, 'C=D' next likely, then rearrange thus:

```
IF E=F AND C=D AND A=B THEN ...
```

The reason for doing this is that the interpreter will stop comparing when the first condition it meets fails the test. Of course, this will be done only after the interpreter has arranged the conditions into its internal form for most efficient evaluation.

11. Use Boolean algebra to evaluate conditional expressions so that they contain as few operators as possible, for example:

```
IF A=B AND C=D OR E=F AND
C=D OR G=H AND C=D THEN ...
```

should be arranged as follows:

```
IF (A=B OR E=F OR G=H) AND
C=D THEN ...
```

With Boolean algebra the operators, AND, OR and NOT can be considered similar to the arithmetic operators *, + and -, respectively. The same arithmetic rules can then be applied to remove common subexpressions.

12. POKEing memory is faster than using byte arrays, but this method doesn't work across the Tube, for example:

```
10 ?&B00=1
20 I=?(&B00+1)
```

Line 10 puts the value 1 in location &B00 and line 20 stores in 'I' the contents of

location 1 offset by &B00 – ie location &B01. This is similar to the byte array description given in the section on reducing program size (see below).

13. The THEN keyword in an IF ... THEN statement is optional and may be omitted to improve speed, for example:

```
IF A%>8 A%=A%+1 ELSE
A%=3
```

14. An expression can contain an in-line implicit IF statement, remembering that TRUE has the value -1 and FALSE the value 0, for example:

```
Z%=A%>0
```

will set Z% to -1 if A%>0 or to 0 if not. Also, they can be more complex, for example:

```
A%=- (A%>8) - 3*(A%<9)
```

The above line might look a bit off-putting at first, but this is what happens:

- a) if A%>8 and A%<9 implies A%=-(-1)-3*(-1) which is 4
- b) if A%>8 and A%>=9 implies A%=-(-1)-3*(0) which is 1
- c) if A%<=8 and A%<9 implies A%=- (0) -3*(-1) which is 3
- d) if A%<=8 and A%>=9 implies A%=- (0) -3*(0) which is 0

Also, expressions using implicit IF statements are fast in execution, but they take up more space. Space can be saved as this format allows multiple conditional statements in a single line, which is not normally possible.

Reducing program size

The size of a program can be reduced by using short variable names, but its readability is reduced.

Bear in mind that arrays start from subscript 0, not 1 as in most Basics. This will gain a few bytes in the interpreter work area if you use the subscript 0 and dimension the array by one less.

DISC DRIVES

FOR THE
BBC
MICRO

CHASE DATA LTD

UNIQUE FACILITY: Only CHASE DATA utilise the two colour LED on the Canon 221 disc drive to show track mode selected and ready status:

40 track mode : LED Green
80 track mode : LED Red
Power on : Half-illumination (red or green)
Selected drive : Full-illumination (red or green)

1 YEAR
WARRANTY
ALL PARTS
& LABOUR



110/210 DUAL
DRIVESYSTEM



221 DUAL
DRIVESYSTEM

CHASE DATA LTD are pleased to announce the launch of the latest generation of Canon disc drives – the ultra slim model 221 (double sided 80 track) – TRULY SUPERB VALUE FOR MONEY

All inclusive means

Disc drive + case + all power and data cables + U.K. carriage + utilities disc & manual + V.A.T.

Quality product

The Model 221 is available with its own custom-built secondary switching power supply. Safe, low in heat generation and outstanding value at £25 (inc. VAT)

Full service support

Our units come with a full 1 year warranty on parts & labour. Disc drive service is via the leading U.K. Independent Drive Service Company.

EPROMS 2764-250 nS £5.75p each.

Send remittance (Cheque only please) with your order to:

CHASE DATA LTD

P.O. Box 6, Woking, Surrey GU21 4PB. (Tel: 0784 38487).

All inclusive price list

MODEL	110	210	221
FORMATTED CAPACITY OF SINGLE DRIVE ON BBC MICRO	100K	200K	400K
SINGLE DRIVE IN CABINET	£170	£198	£236
DUAL DRIVE IN CABINET	£320	£370	£437

All units available with on-board power supply.
Additional cost: £25.



RAPID RETRIEVAL TAPED

Storage made easy, by John Bexon

THE program called *Loader* (listing 1, yellow page vi) makes possible rapid retrieval of any selected program previously stored, but you will need a tape recorder with both motor control and a tape counter. The program will work with any model BBC and Electron.

In its fullest version it requires about 4k of memory in addition to that occupied by any program on which it is to operate. But since the program runs in mode 7 (mode 6 on the Electron) this should not impose much restriction on memory use, and removal of all REMs and spaces can reduce memory requirement. If the presence of *Loader* prevents a program from running in, say, mode 0 you can overwrite it when loading.

First, *Loader* has to be typed in. If you have an early version BBC with OS0.1 then you should add the lines in listing 2 to the main listing. The program should be saved at the beginning of a blank tape. Start recording just beyond the tape leader.

Follow the instructions in table 1 when saving programs. When the routine is finished your program will have been saved and a new version of *Loader* will have been recorded at the beginning of the tape that includes data on the program saved.

Having a number of programs saved on the tape with *Loader* at the beginning, loading a selected program is carried out using the procedure in table 2. It will soon become evident, especially with short programs, that having to load the loader as well as your selected program is time-consuming, but random searching, using \rightarrow CAT to find your program and false

LOADS will all be eliminated. Instead an accurate and rapid search and load routine is available.

Furthermore, when you have enough programs on the tape large sections of the loader program can be deleted. For example, all the SAVE and associated routines will no longer be required. Thus the length of the program can be reduced to little more than 1k.

Loading time, however, is the critical factor rather than memory requirement since your selected program may eventually overwrite the loader. Short programs will load in less than 30 seconds.

The program uses many of the special features of the BBC micro, such as user-defined function keys, procedures, functions, automatic tape motor control and byte and string indirection.

The February 1983 issue of *Acorn User* introduced a technique whereby programs may directly alter sections of themselves. This technique is used in *Loader* to insert a new data statement into the program each time a new program is saved. In this way fast-forward wind-on times of the tape are recorded for subsequent use when you are loading programs.

When first loaded, or typed in, the loader program contains only one data statement at line number 1001, ie, DATA Loader,1100,1. This consists of the name of the program, the fast-forward wind-on time for the start of the next program and the number of the program. The fast-forward wind-on time of 11 seconds (1100 centi-seconds) is necessary to leave room on the tape to record a longer loader program each time the program extends

itself by a one-line data statement for each new program saved.

Since there is only one data statement at this stage, and the program attempts at Line 630 to restore data at line 1002, any attempt now to load another program using *Loader* will result in a 'No such line' error. No attempt has been made to trap this error.

The first thing to do therefore is to record one or more programs using the procedure given in table 1. If step 2 is omitted the program will ask you to start again because it is essential to have the program to be saved in the lower part of user memory, ie, starting at PAGE = &E00. The position of PAGE is then changed by step 3 so that the loader can be held in memory simultaneously with the program to be saved. (The positions are reversed when loading.)

It is not sufficient to set PAGE = TOP since PAGE is always set by the computer to the next lower page boundary; for example, if TOP = &19F1 PAGE would be set to &1900 and the end of your program would be overwritten by the loader. Consequently, PAGE is set to TOP + 256 to make sure that the new value, when rounded down, is clear of the first program.

The *User Guide* (page 317) warns of a danger here but does not explain the problem or give a solution.

Loading *Loader* starting at the new value of PAGE now allows the loader program to operate on the program to be saved. As *Loader* extends itself it is liable to overwrite its own variables which are normally stored in memory immediately above the Basic program area. To avoid this, overwriting LOMEM is raised by half a block in line 50.

Line 60 sets aside a memory block to be used by the command line procedure, PROCcli(c!\$), to pass SAVE commands to the computer's command line interpreter so that saving can be carried out from within the program.

Next, in line 80 the break key is set to allow a jump back to the lower program after the SAVE routine.

If you have a BBC OS version 0.1 the next section of the program, including a new line 80 and up to line 230 from listing 2, is a slightly modified version of the patch, as published in the September 1982 issue of *Acorn User* (page 61) to cure bugs in the cassette filing system. It is convenient to load this patch here so that

1. Type in or load from another tape the program to be saved
2. Type PAGE = TOP + 256
3. CHAIN the loader program and leave the cassette in the recorder
4. From the menu presented choose option 2 (SAVE)
5. Follow the program's instructions and answer the questions that appear on the screen (a single key-press - Y for yes - is mostly all that is needed apart from operating the

- cassette recorder). When the computer prompts 'RECORD then RETURN' the tape recorder should be set to RECORD and after no more than one or two seconds the RETURN key should be pressed (this sequence occurs twice during the SAVE routine)
6. Repeat this procedure for each program to be recorded on the tape

Table 1. Saving programs using 'Loader'

there will be no difficulties with saving and loading after using the loader (Electron and BBC users of OS > 1.0 must omit this section of the program).

Next (lines 250 to 270) the initial menu is presented. The byte indirection in line 260 ensures the use of upper case characters when you choose from the menu. Otherwise the program will hang up at line 270, which accepts only characters 1 or 2 as valid input. (?216=48 can be used to obtain lower case letters - ie this byte indirection sets the CAPS LOCK.)

If the save option is chosen you will be asked to input the name of your program before starting the procedure PROCsave at line 310. First, this procedure used the function FNC(TP%) to look back from the end of the program to find the number in the last data statement of the last program recorded. Then from this number the line number of the last data statement can be calculated simply by adding 1000. It is important therefore that the loader program should always have data statements numbered from 1001 onwards - so beware if renumbering. The ability to RESTORE a particular data line is then used to read data for the last program recorded so that the fast-forward wind-on time to the end of the recording can be used to position the tape ready to save the next program.

The tape is rewound to the beginning, as this position provided a constant reference point for all wind-on times. The procedure PROCrew does the rewinding. PROCff simply checks that you are ready for the fast-forward wind-on. Lines 370 to 380 carry out the winding on for the time S% which was read from the last data statement. When the tape stops and you have pressed the stop key as instructed you are ready to make your new recording. This is done simply by setting the recorder to RECORD and pressing return. As indicated in table 1, a short pause before pressing RETURN is all that is needed. Any more than 1 or 2 seconds will mean a longer wait when subsequently loading the program.

Having saved the program, it remains to record the new fast-forward wind-on time. The program now takes you to PROCdata, where you rewind to the beginning of the tape again and the computer measures the fast-forward time to the end of the program. You have to help by watching the tape counter and pressing any key when the end of the latest recording has been reached. Overshoot somewhat when doing this to leave a gap on the tape before the next program to be recorded. Stopping the tape short of the appropriate point is, however, potentially disastrous as the next recording could overwrite the end of the present one.

The computer now has all the information to create a new data line which it

does by generating the text of the line as a string, N\$, in line 500. This string consists of a space, the name of the program number, all concatenated into N\$. Contrary to the description of the line structure in BBC Basic given by Joe Telford in *Acorn User*, February 1983 (page 22) it is actually as shown in figure 1. (Try programming

```
Line number - 2 bytes
Line length - 1 byte
Basic keyword token - 1 byte (&DC for "DATA")
Line contents - of variable length in ASCII form
Line feed (End of line marker) - 1 byte (&OD)
End of Basic program marker - 1 byte (&FF)
```

Figure 1. Line structure at end of program

key f9 as follows and use this key to examine how the end of the program is stored in memory from TOP downwards:

```
*KEY 9 FOR N% = TOP TO
(TOP - 21) STEP
- 1:PRINT;N%;?N%;SPC(3);IF
?N% < 32 PRINT:NEXT:ELSE PRINT
CHR$(?N%):NEXT;N;L;M)
```

The text, N\$, of the line must therefore be preceded by four bytes - line number, line length and Basic keyword - and followed by one byte: line feed, ie, five bytes. The two bytes for the line number are calculated in line 510 from (1000 + program number) and the line length in line 520 from the length of N\$ plus the five extra bytes. All this information, together with the end of program marker, is then concatenated into P\$ and string indirection used to POKE it where the previous end of program was situated.

Finally the new loader has to be recorded at the start of the tape, so a final rewind is necessary, followed by a short fast-forward to jump over the tape leader. After the stop key on the tape recorder has

been pressed the loader is saved by setting the recorder to RECORD and pressing RETURN in quick succession.

If you wish to return to your original program, pressing BREAK will reset PAGE and run the program. If, however, you wish to use Loader to load another program first press BREAK and then ESCAPE and follow the instructions in table 2.

Clearly, when you have many short programs or several long ones recorded on one tape the fast-forward wind-on times for the later programs will become tediously long. Short tapes, say C15, should be used - certainly none longer than C30.

When you have recorded on one tape as many programs as you feel are convenient it is possible to reduce loading times by deleting sections of the loader program that are no longer required. Before doing so, make a copy of Loader on a new tape, unless you have a back-up copy. Pruning is best done before finally saving Loader after recording the last program on the tape. Thus, during the final save routine, after pressing stop on the tape recorder press ESCAPE and type DELETE 250,590 followed by RETURN. This erases the initial menu (since you will want to load only from this tape in future) and all parts of the program associated with saving. In addition you may also remove all REMs and blank lines, reducing loading time for the loader to a minimum. However, resist the temptation to renumber the program after pruning - remember that the data statements *must begin at line 1001*. When starting to use your copy of the full version of Loader on a new tape remember to delete all lines above, but not including 1001.

When pruned, Loader shows its true worth. Any program on the tape can now be accessed with a minimum of bother, having been easily selected from a clearly presented index which itself gives a quick listing of the contents of the tape.

1. Wind to the beginning of the tape and CHAIN the loader
2. From the menu presented choose option 1 (LOAD)
3. Select the program of your choice from the list presented or press the space bar (if you inadvertently reach the end of the list press Y when asked if you wish to try again). When you see the name of the program you wish to load select the number indicated
4. Follow the program's instructions and answer the questions that appear on the screen. The computer will then control a fast wind-on to the start of the program and you will be asked about memory requirement of the program
5. If in doubt about the amount of memory needed, respond by pressing any key except Y. The program will now CHAIN the program, unless a 'No room' error occurs
6. If a 'No room' error occurs press BREAK and try again, but choose the maximum memory option this time
7. You may return to Loader at any time by pressing BREAK except when Loader has been overwritten after choosing the maximum memory option

Table 2. Loading a program

**THIS IS
THE BIG ONE!**

The 2nd Official Acorn User Exhibition

**Everything for the
BBC Micro and Electron user**

OLYMPIA 16-19 AUGUST 1984

Organised by Computer Marketplace (Exhibitions) Ltd
20 Orange Street, London WC2H 7ED

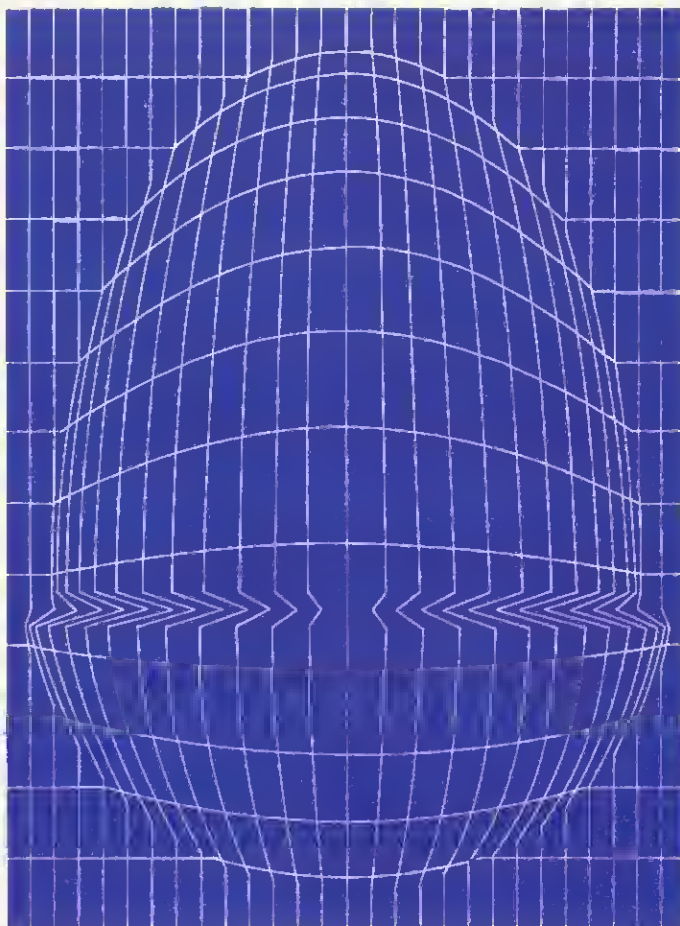

© Captain Advertisina Ltd 01-930 1612

BIG VALUE

The success story of Acorn Computers, the BBC Micro and Electron is mirrored by suppliers who have produced more and more hardware, software, supplies and services. And they'll all be at the exhibition – disk drives, plotters, printers, monitors, joysticks, robots, books and magazines, all kinds of software – everything for the Acorn owner.

And of course Acorn will be there in force with all their latest developments and software.

There'll be special offers, competitions, advice centres and special events as well.

And all this for only £3.00 at the door, under sixteens £2.00. (Use the coupon to beat the queues and save £1.00).

BIG VENUE

Olympia 2 is the brand new exhibition centre next to the old Olympia. It's got everything, wide gangways, lots of space to sit down and rest, plenty of catering areas.

Getting there is easy too, it's got its own tube station, bus routes 9, 27, 28, 33, 49, 73 and 91 go right past the door, and there's car parking too!

BIG SUPPORT

Remember this is the *Official Acorn User Show*, it's the most informative prestigious and influential user show in the country. Whether you're a businessman, serious user or games enthusiast there's something for you.

For details of exhibition stands and advance ticket sales contact the organisers.

Computer Marketplace (Exhibitions) Ltd. A Rushworth Dales Group Company, 20 Orange Street, London, WC2H 7ED Tel: 01-930 1612

BEAT THE QUEUES! SAVE MONEY! ORDER YOUR TICKET IN ADVANCE.

Buy your ticket now and save queuing. There will be special entrances for advance ticket holders.

Please send me _____ (qty) tickets at £2.00 and _____ (qty) under sixteen tickets at £1.00. I enclose my cheque/PO to the value of £_____ or debit my Access card. No. _____

NAME _____ SIGNED _____

ADDRESS _____

POSTCODE _____

GROUPS – Order 15 or more tickets and you qualify for a further 20% discount.

To: Computer Marketplace (Exhibitions) Ltd. A Rushworth Dales Company, 20 Orange Street, London WC2H 7ED.

◀ page 79

When using FOR loops that have integers as their indexes and increment values, try to use the same variable (except for nested loops) – for example, I%, J%, K%. Creating unnecessary variables will consume stack space, the free area between TOP (end of program) and HIMEM (bottom of display area). The interpreter allocates an area in this region (starting at the value of LOMEM) for the variable names, variable type (real, integer, string or array of either type) and the address of its value.

The resident integer variables (A% to Z%) are already allocated by the interpreter, so if these are used the interpreter doesn't spend time creating the space for them (page 66 of the *User Guide*).

84

With BBC Basic a real number will use five bytes of memory whereas integers (eg, I%, FRED%) use only four bytes (a fact I keep forgetting as I use a variety of computers in my job).

Using multiple line statements saves five bytes for each line number (pages 54 and 98, *User Guide*).

Pre-declaring strings causes the interpreter to allocate the string space once only.

Declare strings to the maximum length that they will become in the course of the program, for example:

```
A$ = STRING$(25, " ") or
A$ = STRING$(255, " ")
```

The interpreter doesn't do any garbage collection; when a string is first declared, for example A\$ = "FRED", it allocates the space needed to store the string – in this case five bytes (one byte for the count), but if any subsequent declaration causes the string to be lengthened, the original space is lost (de-allocated) and new space reserved (allocated) for the longer string.

If, when using arrays, the values stored in the array are all integer and are in the range 0 to 255, byte arrays can be used to remove the three redundant bytes per array element, for example:

```
DIM BOARD 128
```

The byte array BOARD is then accessed by:

```
BOARD?1% = 0
```

and

```
X = BOARD?1
```

FURTHER READING

The following books will interest programmers who want more detailed information on how an interpreter/compiler works and those wishing to write their own interpreter/compiler (the first isn't too technical as it doesn't delve into the realms of compiler theory and high-level optimisation techniques):

'Writing Interactive Compilers and Interpreters' by P J Brown (Wiley)

'A Dynamic Incremental Compiler for an Interpretive Language' by E J Van Dyke (Hewlett-Packard Journal).

STOP PRESS

CUMANA PRICE LIST

Cumana BBC Microcomputer compatible disk drives: retail prices

Cumana disk drives supplied with formatting diskette, drive connecting cable and comprehensive user manual. Independent power supply, mains lead and moulded plug included.

CS100 Single 40 Track single sided	£169
CS200 Single 80 Track single sided	£209
CS400 Single 80 Track double sided	£233
CD200 Dual 40 Track single sided	£305
CD400 Dual 80 Track single sided	£386
CD800 Dual 80 Track double sided	£431
CD400/S Dual 80/40 Switchable single sided	£469
CD800/S Dual 80/40 Switchable double sided	£499

Cumana disk drives with independent power supply, mains lead and plug. Excluding other accessories.

CS100E Single 40 Track single sided	£153
CS200E Single 80 Track single sided	£195
CS400E Single 80 Track double sided	£219

Cumana disk drives supplied with formatting diskette, drive connecting cable and comprehensive user manual. Power supply taken from BBC Microcomputer, with lead supplied.

CSX100 Single 40 Track single sided	£149
CSX200 Single 80 Track single sided	£193
CSX400 Single 80 Track double sided	£215

- ★ Top quality 5¼ inch TEC and Mitsubishi Japanese disk drives
- ★ Fully assembled and tested before packaging
- ★ 12 months warranty
- ★ Attractive hardware cabinets in BBC beige

Available from the following retail outlets:

W. H. Smith, John Lewis Partnership, Greens Leisure, Laskys, Spectrum UK

Area distributors:

HCCS Associates (Gateshead) 0632-821924, Eltec (Bradford) 0274-722512, Basic

Business Systems (Nottingham) 0602-819713, Walters Computer Systems

(Stourbridge) 03843-70811, Microage Distribution (North London) 01-205 7688,

J. S. Simnett Computers (South London) 01-390 6161, Ferranti & Craig (Basingstoke)

0256-69966, Gwent Computers (Wales) 0633-859592, National Micro Centre

(Stockport) 061-456 9548, Microworld (Edinburgh) 031-228 1111,

Microtest (Cornwall) 0208-3171.

REMEMBER...

+ National Dealer Network
Please note: all prices exclude VAT
and delivery charges

...THE BEST NAME IN MEMORY



Print from Japan

Disk Drives from Cumana



Like the beautiful prints from Japan, Cumana disk drives represent the very highest standards in design and production. Also like the prints, Cumana disk drives represent the highest state of the art; and they not only look beautiful, they perform beautifully as well.

Cumana disk drives for the BBC Microcomputer are available in slimline single, dual and dual switchable versions. They have 12 months warranty, are fully assembled and tested before packaging, and are available — at unbeatable value for money prices — from W. H. Smith, The John Lewis Partnership, Greens Leisure, Laskys, Spectrum UK, area distributors (see below) and Cumana's national dealer network.

Look out for the distinctive Cumana packaging in your high street, today!



Area distributors:

HCCS Associates (Gateshead) 0632-821924, Eltec (Bradford) 0274-722512, Basic Business Systems (Nottingham) 0602-819713, Walters Computer Systems (Stourbridge) 03843-70811, Microage Distribution (North London) 01-205 7688, J. S. Simnett Computers (South London) 01-390 6161, Ferranti & Craig (Basingstoke) 0256-69966, Gwent Computers (Wales) 0633-859582, National Micro Centre (Stockport) 061-456 9548, Microworld (Edinburgh) 031-228 1111, Microtest (Cornwall) 0208-3171, DRG Business Machines (Weston-Super-Mare) 0934-415398, Kingdom Design (Belfast) 0232-643720, Hugh Symonds (Bournemouth) 0202-26535, Audio & Computer Centre (Jersey) 0534-74000.

The Highest State of the Art



Cumana Limited,
Pines Trading Estate, Broad Street,
Guildford, Surrey, GU3 3BH.
Telephone: Guildford (0483) 503121.
Telex: 859380.

For further information about Cumana disk drives for the BBC Micro, please complete and return this coupon.

Interests:

Home Use

Education

Dealer

Business

Name _____

Address _____

Tel. No. _____

AU 6/84

Note: If dealer, please attach this form to your letterheading.

MACRO SAVINGS FOR MICRO USERS

**DUAL
DISK DRIVE
SYSTEM**
UCL 100DB
£289.95
**DELIVERED TO
YOUR DOOR***
NO EXTRAS!
(Computer not included in price)



ALL DISK DRIVE UNITS
COME COMPLETE WITH:

- Ribbon cable to connect to BBC Micro
- Power cable to connect to BBC Micro
- Power cable to mains where PSU is fitted
- Manual and formatting disk

**ABSOLUTELY
NO EXTRAS -
ALL READY TO
PLUG IN AND RUN**



UCL 100C £135.95

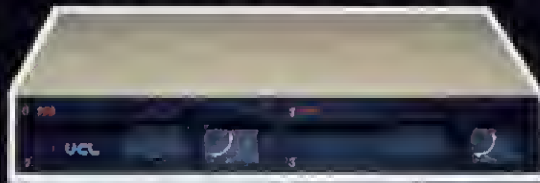

UCL 100D £269.95



UCL 100DS £269.95

DISK DRIVES AND DISKS. ALL CASES COLOUR MATCHED TO BBC.

ALL DISK DRIVE UNITS COME COMPLETE WITH:
• Ribbon cable to connect to BBC Micro • Power cable to connect to BBC Micro • Power cable to mains where PSU is fitted • Manual and formatting disk and includes Packing Postage and Insurance
ABSOLUTELY NO EXTRAS - ALL READY TO PLUG IN AND RUN

UCL 100C	Cased, single sided, double density, 40 track 250K Unformatted Chinnon FDD 155 disk drive Formatted 100K BBC single density Formatted 200K BBC double density	£135.95
UCL 100D	Dual side by side case with two single sided, double density 40 track 250K unformatted Chinnon FDD 155 disk drives Formatted 100K x 2 BBC single density Formatted 200K x 2 BBC double density	£269.95
UCL 100DS	Dual stacker case with two single sided, double density 40 track 250K unformatted Chinnon FDD 155 disk drives Formatted 100K x 2 BBC single density Formatted 200K x 2 BBC double density	£269.95
UCL 100DB	BBC matching styled case with two single sided, double density 40 track 250K unformatted Chinnon FDD 155 disk drives Formatted 100K x 2 BBC single density Formatted 200K x 2 BBC double density	£289.95
UCL 200C	Cased, double sided, double density 40 track 250K unformatted TEAC 55B disk drive Formatted 200K BBC single density Formatted 400K BBC double density	£175.95

UCL 200D	Dual side by side case with two double sided, double density 40 track 500K unformatted TEAC 55B disk drives Formatted 200K x 2 BBC single density Formatted 400K x 2 BBC double density	£339.95
UCL 200DS	Dual stacker case with two single sided, double density 40 track 500K unformatted TEAC 55B disk drives Formatted 200K x 2 BBC single density Formatted 400K x 2 BBC double density	£339.95
UCL 200DB	BBC matching styled case with two single sided, double density 40 track 500K unformatted TEAC 55B disk drives Formatted 200K x 2 BBC single density Formatted 400K x 2 BBC double density	£359.95
UCL 400C	Cased double sided, double density 80 track 1mb unformatted Mitsubishi M4853 disk drive Formatted 400K BBC single density Formatted 800K BBC double density	£199.95
UCL 400D	Dual side by side case with two double sided, double density 80 track 1mb unformatted Mitsubishi M4853 disk drives Formatted 400K x 2 BBC single density Formatted 800K x 2 BBC double density	£389.95
UCL 400DS	Dual stacker case with two double sided, double density 80 track 1mb unformatted Mitsubishi M4853 disk drives Formatted 400K x 2 BBC single density Formatted 800K x 2 BBC double density	£389.95

UCL 400DB	BBC matching styled case with two double sided, double density 80 track 1mb unformatted Mitsubishi M4853 disk drives Formatted 400K x 2 BBC single density Formatted 800K x 2 BBC double density	£412.95
UCL 4080C	Cased double sided, double density 40/80 track 500K/1mb unformatted TEAC 55F disk drive	£219.95
UCL 4080D	Dual side by side case with two double sided, double density 40/80 track 500K/1mb unformatted TEAC 55F disk drives	£419.95
UCL 4080DS	Dual stacker case with two double sided, double density 40/80 track 500K/1mb unformatted TEAC 55F disk drives	£419.95
UCL 4080DB	BBC matching styled case with two double sided, double density 40/80 track 500K/1mb unformatted TEAC 55F disk drives	£442.95

CONTROL DATA FLOPPY DISKS

SSSD 48 TPI Per Pack of 10	£13.80	DSDD 48 TPI Per Pack of 10	£18.97
SSDD 48 TPI Per Pack of 10	£14.37	SSDD 96 TPI Per Pack of 10	£21.85
DSDD 48 TPI Per Pack of 10	£18.97	DSDD 96 TPI Per Pack of 10	£23.57

PRICES INCLUDE VAT, DELIVERY * & PACKAGING

EPSON DOT MATRIX PRINTERS

RX801 80 Column 100 CPS	£259.95
RX80FT 80 Column 100 CPS...	£289.95
FX80 80 Column 160 CPS	£399.95
MX100FT3 136 Column 100 CPS	£425.95
FX100FT 136 Column 160 CPS	£525.95

STAR DOT MATRIX PRINTERS

Gemini 10X 80 Column 120 CPS	£229.95
Gemini 15X 136 Column 120 CPS	£339.95
Delta 10 80 Column 160 CPS	£369.95
Delta 15 136 Column 160 CPS	£499.95
Radix 10 80 Column 200 CPS	£525.95
Radix 15 136 Column 200 CPS	£599.95

DAISYWHEEL PRINTER

Juki Model 6100 20 CPS	£395.95
Juki Triactor	£99.00
Juki Cut Sheet Feeder	£239.00
Ricoh RD 1300S	£995.95
Ricoh RD 1600S	£1395.95
Triactor (Bi Di 1600)	£175.00
Mechanical Sheet Feeder	£485.00
BBC Cable	£12.00

PRICES INCLUDE VAT, DELIVERY * & PACKAGING

14" STANDARD RESOLUTION MICROVITEC COLOUR MONITORS

- Matching BBC COLOURS • RELEASABLE 12 MONTHS WARRANTY
 - 40-64 CHARACTERS • DOT PITCH 0.63mm
 - FULLY COMPATIBLE WITH MOST COMPUTERS
 - LOW POWER CONSUMPTION • BRITISH MANUFACTURE
- PRICE INCLUDES VAT, DELIVERY * & PACKAGING **£199.95**

UNIVERSAL COMMUNICATIONS COMPANY

ROYD NOOK, ROYDSTONE ROAD,
BRADFORD, WEST YORKSHIRE,
TEL: BRADFORD (0274) 390114



ORDER FORM — FILL IN THE ORDER FORM AND SEND IT WITH REMITTANCE TO: —

Universal Communications Company, FREEPOST, Roydnook, Roydstone Road, Bradford, W. Yorkshire BD3 7BR.

PLEASE SUPPLY THE FOLLOWING

ITEM	QTY.	PRICE	TOTAL
PLEASE ALLOW 28 DAYS FOR DELIVERY *DELIVERY TO ANY ADDRESS IN U.K.			TOTAL PAYABLE

NAME.....
ADDRESS.....
.....POSTCODE.....
TEL. NO.....

I enclose a cheque/PO for a total of £.....
made payable to U.C.C.

Signed.....

STOP PRESS **FREE PROGRAMS** *

Proxima

**PERSONAL
COMPUTER
SOFTWARE**

PROXIMA SOFTWARE has been chosen as the official publisher of the following BBC and ELECTRON programs written by members of the COMPUTER USERS CLUB, in addition to our own forthcoming software.

TWO PLAYER GAMES DUET

Choose between playing against a friend or the computer and choose between 4LINE and FRUSTRATION, two classics in one. There's also a joystick option. The choice is yours...



RQBQ BRAIN

Control the Gremlins to disable the mad Robot's positronic brain, but avoid the deadly Pulses which have been sent out by the robot to get you! Work fast, because those pulses reverse any work you've achieved.



BEEB-TEXT

A sophisticated and highly original machine-code program which allows virtually unlimited variation in style of displayed text including shadow, outline, italic, thickness, height, width, line spacing, colour combinations, etc. Eight fonts are available in modes 4 and 5 and it is ideal for imaginative displays and titling - especially video titling. Available on disc only.



Beeb-Text!

▲ Drop us a line for our detailed catalogue and price list.

GAMES QUARTET

Full value and variety from four colourful and exciting action and strategy games for the price of one, including TRAWLER, LIGHT CYCLES, STARGAME and an almost unbeatable 3D TIC-TAC-TOE.



DISC TOOLS

A Utility Disc especially useful for users of twin 80 track drives including a 40/80 track backing up facility, a disc identifier & verifier, a 35/40/80 track formatter with automatic verification and a comprehensive menu file.



BIG PRINT

By the author of Beeb-Text, this is a machine-code routine which can be incorporated into your own programs to display variable size height and width text.



PIXEL PACKAGE

Two machine-code programs for the price of one. Firstly there's an excellent single colour character designer and secondly a four colour (from 16 colour palette) character designer and print routine.



PROXIMA PERSONAL COMPUTER SOFTWARE, Newlands, 30 Sparelease Hill, Loughton, Essex, IG10 1BT. Tel. 01-502-0230

	BBC model B	
	Disc	Cassette
DISC TOOLS	£10.95	
BEEB-TEXT	£15.00	
PIXEL PACKAGE *	£10.95	£7.95
BIG PRINT *	£8.95	£5.95
TWO PLAYER GAMES DUET *	£9.95	£6.95
GAMES QUARTET	£10.95	£7.95
ROBOBRAIN	£10.95	£7.95

* Contact us, because we have a limited Special Offer, we are GIVING programs away with all orders. Please write or phone for details.

▲ From this month onward, P&P on all orders is FREE!

▲ Prices are fully inclusive, no extra to pay.

* Available on Electron
 ▲ Please specify 40 or 80 track or 3" types when ordering discs.
 ▲ Please make cheques/P.O's payable to PROXIMA SOFTWARE.



LET YOUR BBC SYSTEM GROW ON A ZYGON STAND



NEW ZYGON DELTA £96
(plus £7 p&p + VAT)

The Zygon range starts from £59 (+ VAT)

Dealer and Educational enquiries welcome.
 Telephone: Hoddesdon (0992) 466259.

ZYGON. The purpose-designed stand for the BBC Micro. The BBC system is designed to expand. The Zygon range grows with it.

ZYGON DELTA. The top-of-the-range Zygon Delta provides lots of space for a total, comprehensive computer system. Space not only for your BBC Micro and monitor but also for your disc drives, printer, interfaces and modems, as well as for a second processor. The lower computer shelf slides away for full keyboard protection and, on castors, can easily be moved from room to room.

- Upper shelf measures 1270 x 480mm.
- Lower shelves measure 1270 x 550mm.

To: Zygon Products, FREEPOST, 9 Sheredes Drive, Hoddesdon, Herts, EN11 8BR
 Please send me (No stamp required)

.....ZYGON DELTA Stands at £118.45 (incl. p&p and VAT)

.....Brochure of the complete Zygon range. I enclose cheque for £..... payable to Zygon Products.

Name:.....

Address:.....

..... Postcode.....

Allow 28 days for delivery. Full refund if goods returned undamaged within 14 days.



SLAVES FROM AROUND £49!

THE BEASTY

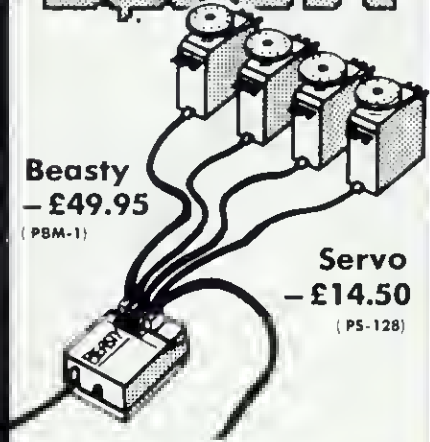

Beasty
- £49.95
(PBM-1)

Servo
- £14.50
(PS-128)

Servos:
FROM - 1-4 servos, 3.5kg/cms
60 degrees in 0.25 secs, 100 degrees range.

COMMOTION
COMPUTER OPERATED MOTION

241 Green Street, Enfield EN3 7SJ
Telephone: 01-804-1378

Unlock your computer, and give it the power to do your donkeywork. How? By employing a beasty.

A beasty, with up to 4 servos, allows the computer to manipulate a variety of objects - from pushing buttons to controlling the environment in a greenhouse.

We've also come up with a robotic building system which you can use to create the arm shown here. Moments and levers will come to life as you experiment with many different structures.

We can give you computer sight, too. Our revolutionary vision system - SNAP - captures quality moving images which can be displayed on your monitor or printed out. They can also be analysed, processed and enhanced by using the software suite provided.

All our products are 'plug in and go', and are available for the BBC Model B. Versions for ORIC, ATMOS, Commodore 64 etc. are presently under development.

And you can start with the whole kit - the beasty, beasty arm and four servos, and the vision system. Or, if you're feeling a little nervous about controlling all this new-found power, your computer can be given its freedom with as little as one beasty and one servo.

So don't waste any more of your valuable time, doing the jobs your computer can handle for you once it's been released. Send for your personal slave right now.

Postage and packing £1.25

ACCESS

Your money will be refunded in 14 days if you're not completely satisfied

THE BEASTY ARM

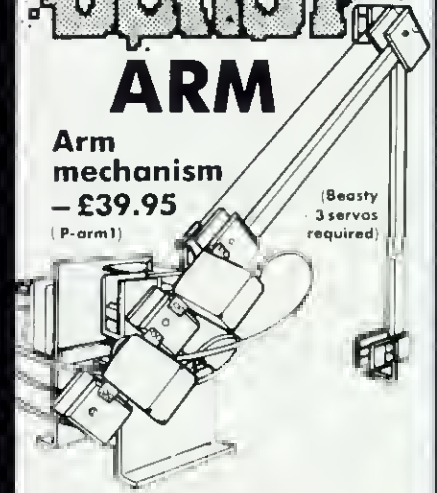

Arm mechanism
- £39.95
(P-arm1)

(Beasty
3 servos
required)

Beasty Arm:
Maximum reach: 340mm, maximum lift:
400mm, maximum load 75gms, point to
point time: less than 0.5 secs

SNAP VISION SYSTEM

Resolution up to 256x128, up to 20 frames/
second, up to 8 grey levels. **SNAP - £129.95**
(P-Snap1)

3D COMPUTERS

THE HOME COMPUTER
SPECIALISTS

WITH MORE BRANCHES THAN
ANY OTHER ACORN DEALER
WE OFFER

ONE-STOP SHOPPING

FOR YOUR
BBC MICRO
AND
ELECTRON

CALL IN AT YOUR LOCAL
BRANCH FOR FRIENDLY
ADVICE AND SERVICE
SEE A COMPLETE DISPLAY
OF HARDWARE & SOFTWARE
TO BUILD UP YOUR
ACORN MICRO SYSTEM

SOFTWARE

PROGRAM POWER
BUG-BYTE
SUPERIOR SOFTWARE
A & F
SIMON HESSEL
MOLIMERX
ALLIGATA
ACORNSOFT

PERIPHERALS

DISCS SINGLE/DUAL
TORCH Z80 DISCS
CUMANA DISCS
PRINTERS
JOYSTICKS
MONITORS
B & W/COLOUR
LIGHT PENS
BBC BUGGY

*large range of books,
diskettes, cassettes &
printer paper always
in stock*

*Easy parking at all
branches*

TOLWORTH

230 Tolworth Rise South,
Tolworth, Surbiton,
Surrey KT5 9NB.
Tel: 01-337 4317

SUTTON

30 Station Road,
Belmont, Sutton,
Surrey SM2 6BS.
Tel: 01-642 2534

EALING

114 Gunnersbury Avenue,
Ealing, London W5 4HB.
Tel: 01-992 5855

NEWBURY

26, Stanley Road,
Newbury
Berks RG14 7PB.
Tel: (0635) 30047

RICKMANSWORTH

Grey Stone Works,
The Green, Croxley Green,
Rickmansworth,
Herts WO3 3AJ.
Tel: 0923 779250

LUTON

1 Manor Road,
Caddington, Luton,
Beds LU1 4EE
Tel: (0582) 458575

EAVESDROPPING ON MEMORY

89

THE idea of this article is to provide a means by which the inner workings of the Electron and BBC micro's random access memory can be made visible on the screen. The technique used is simple, as it is just a matter of re-programming one of the registers of a chip. This is the 6845 CRT controller chip whose job it is to look at the contents of the video RAM and generate, in conjunction with the video processor chip, the signals used to produce pictures on a television or monitor screen (see April's issue).

All we have to do is tell the 6845 that video RAM starts at page zero and not where the operating system says. To get the required effect, type in:

```
MODE6
VDU 19,0,4,0,0,0 (or VDU 19;4;0;)
```

to select graphics mode 6 and change the background colour to blue. Then type

```
VDU 23,0,12,0,0,0,0,0,0 (or VDU
23;12;0;0;0;)
```

to do the necessary re-programming of the 6845.

The effect produced is quite startling when first seen. But before trying to explain what it all means, we need to look at how the screen is displayed in mode 6.

Each character on the screen is made up from the information contained in eight consecutive bytes of the screen memory. The next character is then made up from the next eight bytes and so on. Type in run program 1 (see yellow page vii), then each time you press the space bar one more byte will be added to the screen. Eight key presses will give a complete character. Continually pressing the space bar will produce more characters, eight bytes at a time.

The bytes the program is using to poke into the screen RAM are taken from the operating system ROM chip. Stored in memory locations &C000 to &C2FF are bytes defining each of the characters used in modes 0 to 6. (Mode 7 on the BBC has its own character generator in the teletext chip – hence the different character set.) If you want to see the characters much more clearly, run program 2 which displays them in large block form.

See a program actually working!

In the first of a series on the Beeb and Electron, Paul Beverley opens the lid on the inner workings of these very complex machines

Now let's get back to that impressive display we first looked at. To show it more easily and play around, I have included it in program 3. However, before it is loaded in, the user's program space must be moved out of reach of our newly-defined screen which is to occupy memory locations &0000 to &1F3F. (No, that's not a typing error, it should be &1F3F, since $40 \times 25 \times 8 = 8,000 = \&1F40$. The reason mode 6 uses &2000 bytes is that as the screen is scrolled, it sometimes makes use of locations from &6000 right up to &7FFF.)

Moving the user program space up can be done by typing:

```
PAGE = &3000
NEW
CHAIN "BEEBWRK"
```

This assumes you have already typed program 3 in and saved it on tape or disc. (Disc users can make life easier by making the above three commands into a !BOOT file by using the *BUILD command, and entering *OPT 4,3 to set up the disc for an auto-boot. To run the program, just hold the shift key down and press break.)

Having got the flickering bit pattern on the screen, what does it all mean, and how do we interpret it? First of all it shows, if you ever doubted it, that although the micro might appear to be 'doing nothing' it is in fact working all the time.

To refer to different parts of the screen, each line can be thought of as divided up into five sections, each equivalent to eight characters, ie $8 \times 8 = 64$ bytes. Thus the

first four sections of the first line ($4 \times 64 = 256$) are locations 0 to &FF – what we call 'zero page'. One page is 256 bytes. If we refer to these 64-byte sections by their line numbers and section numbers then section 1,5 for example is the right hand end of the first line and is locations &100 to &13F. To check this type in:

```
?&100=0
?&13F=0
```

to see where that is in section 1,5.

If you look at section 3,1 on the screen you will see a lot of activity. At the centre of that section is the regular 'ticking' of the micro's centisecond clock which is used for the TIME functions. To check this, try typing:

```
TIME = -1000
```

This should make two blocks of white appear. After 10 seconds (1000 centiseconds) these blocks disappear. What is happening is that the value of TIME is negative and is represented in binary as lots of ones – hence all the white. There are two complete blocks because the operating system uses two copies of the TIME value to avoid the danger of someone reading the value of TIME just as it is being changed under interrupt. Basic could have just got hold of the first byte when the centisecond interrupt came along. Basic would then pick up the other three bytes after the interrupt had been serviced and, if the TIME bytes had been changed, would give an erroneous value of TIME. Therefore the operating system uses the two sets of values alternately, and

only updates one while the other is being used for reading. Then it switches back and updates the other. The third set of numbers ticking away in step with the TIME bytes is the interval timer which can only be read and written to using OSWORDS 3 and 4. There is no Basic equivalent.

Immediately to the right of the time function is another area of activity, which is the buffer used by the operating system to store the current values from the analogue to digital converter. If you have joysticks, then changing their positions should alter the numbers also. (The best way to demonstrate this, if you can do a bit of soldering, is to make up a single potentiometer connected between Vref and analogue ground with its wiper connected to all four analogue inputs.)

Another way is to use *FX16,0 which switches off the four ADC channels, so all movement in that area ceases. Using *FX16,4 restores the movement as the four channels are re-enabled. With *FX190,8 you should be able to see the effect of changing to eight-bit conversion. However, it is difficult to tell the difference without a high-quality monitor, but program 4 makes the effect more visible. Try *FX190,8 and *FX190,12 before

each run of the program and, in either mode, ADVAL returns the bottom four bits as zeros. In the 12-bit mode, the top 12 bits change with the positions of the joysticks, but with the eight-bit mode, the 11th and 12th bits are permanently at logic 1, while the other 10 bits change as the joysticks are moved. Therefore if you really only want eight bits you will have to switch over with *FX190,8 but then use, for example, ADVAL(1) DIV 256 to remove the top eight bits. The improvement in speed by going to eight bits is something less than 2.5 times. (In theory it should be 4ms compared with 10ms per conversion in the 12-bit mode.)

Before changing the contents of RAM too much it is worth getting some idea of what has happened to the RAM since the micro was switched on. When a reset occurs, the operating system detects whether it is a power-up reset, as opposed to the break key having been pressed, by checking whether any interrupts have been enabled on the system 6522 VIA chip. If no interrupts are enabled, it must have been a power-up reset and so the operating system clears all the RAM from &400 to &7FFF (&3FFF on a model A) to zeros, with the exception of the first byte of each page, ie &400, &500, &600 etc. Some

of these can still be seen as white lines (&FF), eg the beginnings of sections 7,3; 8,2; 9,1 etc.

To see this actually happen, make sure there's nothing in the computer you want to keep, switch to mode 0, and get a bit map with:

```
VDU 19;4;0;
VDU 23;12;0;0;0;
```

Fill up memory by:

```
FOR N% = &D00 TO &5000:
?N% = - 1: NEXT
```

and then type:

```
?&FE4E = &7F
```

This will disable all the interrupts on the internal VIA chip and so the system will stop completely. When you press break, the operating system checks the VIA, sees no interrupts are enabled, and clears memory. Watch carefully as you hit the break key to see the memory being swept clean, except the first byte of each page.

The other point of interest here is that by looking at sections 1,3; 1,5; 2,2; 3,2 and 3,5 you can tell what make of RAM you have in your computer! The different makes of RAM tend to power-up with different values, so those locations that have not

VT100 Intelligent Workstation

Plug the 'Emuterm' ROM into a BBC Microcomputer (Model B) to give the benefits of both a personal computer and a DEC VT100 terminal.

- ★ line speeds to 9600 baud, 3 or 5 wire operation
- ★ almost all VT100 features supported including VT52 mode
- ★ switch between terminal mode and native microcomputer by simple command
- ★ fitted in a few minutes by following the simple instructions
- ★ optional intelligent file transfer mode
- ★ optional numeric keypad (automatically used if fitted)

VT100 Emuterm £35 inc p&p and VAT

Other terminal emulators (inc Newbury 7000 and 8000 series) and communication software available. Please send sae for details.



All orders and enquiries to:

**Applied Real Time Systems Ltd.,
Dept AU, PO Box 32, Sunderland, SR2 7 SN.**

DEC, VT100 and VT52 are registered trademarks of Digital Equipment Corp., Maynard.

been over-written by the operating system or Basic will still show the pattern. Hitachi RAM tends to power-up with sets of 64 bytes equal to zero and 255 (&FF) alternately. Thus section 1,1 was all ones at power up, as was 1,3 and 1,5 etc. Other makes of RAM such as Mostek come up with alternate bytes equal to 0 and 255, so these appear as horizontal stripes.

There is always plenty of activity in section 2,3. This is the area of RAM called 'the stack' which the 6502 uses to remember numbers temporarily – for example, its return address when going off into a subroutine or to service an interrupt. It is this latter use that accounts for most of the activity when the system is sitting waiting for an input from the keyboard.

As soon as anything is typed in on the keyboard you will be aware of the characters going into two different areas of memory. The temporary buffer which the operating system uses is in section 4,1 and the line input buffer that Basic uses starts at section 6,4 and goes on up to and including section 7,3. Keys that show clearly what is going into the buffer are the space bar (ASCII 32 = 00100000 in binary) and the ~ tilde (ASCII 126 = 01111110).

If you type:

```
FOR S% = 0 TO 50000 : NEXT
```

and hold the space bar down, the buffer in 4,1 will fill up, and when Basic has finished executing the FOR ... NEXT loop, the space characters will be transferred to section 6,4 and printed out on the screen. If you now try the same thing, but use the tilde character, you will be able to see it happening even more clearly.

While the FOR ... NEXT loop was being executed you may have noticed extra activity in section 1,1 – the bottom part of zero page. This is a 'scratch pad' area being used by Basic, but in the middle of section 4,3 there was a number ticking away. This was the integer variable, S%, which you were using. Try again with say A% or Z%, or try entering Z% = -1. (Integer variables are represented by four bytes, as explained earlier, -1 in binary is all ones, so that gives a four-byte white block which should be clearly visible.)

To see why TRUE and FALSE take on the values they do, if you have just tried Z% = -1 try:

```
Z% = FALSE
```

and then

```
Z% = TRUE
```

TRUE is represented by minus one since that is all ones in binary, and FALSE is zero since that is all zero.

If you try any of your favourite SOUND and ENVELOPE commands, it will soon be clear where that all happens, and even doing a simple control-G shows that the operating system is counting something



Top: Part of the BBC micro's bit map. Below: Enlarged letters displayed from the micro's ROM.

until the beep stops. To make this clear, use *FX 214,50 to lengthen the beep.

Ardent users of the COPY key may already have noticed that as you copy various characters off the screen, the operating system puts a copy of what it picked off the screen into section 3,3 for comparison with the characters stored in the operating system ROM at &C000 onwards.

Let's reprogram one of the characters:

```
VDU 23,65,16,16,16,16,16,16,16
```

This changes the 'A' character to a single vertical line, and it will be seen that all the characters from @ to Z, plus five punctuation marks, appear on the screen from section 10,4 to 11,2 (&C00 to &CFF). If you type in a command such as PRINT ABS(-1), the 'A' appears as a vertical line, but is acted on correctly. Using the COPY key to re-enter the same line will show that it is still interpreted correctly by the operating system as an 'A'.

If you now re-program a different character in another part of the character generator, such as the lower case letter 'a' using:

```
VDU 23,97,2,2,2,2,2,2,2,2
```

then that character and its associated characters will replace the upper case letters, and things then become really confused as Basic will appear to be working entirely in lower case characters, and trying to use the COPY key on any upper-case characters left on the screen will result in a bleep since the operating system does not recognise them any more.

Programming any of the function keys shows up in sections 9,5 on to 10,3 (&B00 to &BFF) which is initially filled with space

characters. Typing in statements such as:

```
*KEY 1 ~~~~~
```

and

```
*KEY 2 .....
```

will give a clear indication on the screen of what happens as the keys are programmed.

Entering some lines of a dummy program lets you watch Basic doing the editing. Try those lines in the order given:

```
100 ~~~~~
10 @@@@@@@@@@@@@@@@@@
20 JJJJJJJJJJJJJJJJJJJJJJJJJJJJJJJJJ
1 /////////////////////////////////////////////////////////////////
```

and watch the program building up. Then try deleting some of the lines, starting from line 1, and see how Basic shunts the remaining lines up. Then you can try entering NEW and OLD alternately, and perhaps enter a program consisting of a few short lines, and then RENUMBER it.

If you enter a simple FOR ... NEXT loop using a real variable you will be able to see the area above the program being used to store the real variables.

There are lots of other different ideas you can try that demonstrate how the operating system works. If you want, for example, to show how dependent the system is on interrupts, change the interrupt vector IRO1V using:

```
I&204 = RND
```

and see what happens! Almost certainly the 'stack' will suddenly fill up as the system gets tied up in knots.

With a program that uses events, you can illustrate that it forms part of the operating system, and that if corrupted it causes the system to crash. You could use the automatic ADC averaging routines from *Acorn User*, March 1984. If the event is enabled, and you type in:

```
I&C20 = RND
```

you will see the effect on the system. What will probably happen is that the stack simply goes round and round in circles.

A routine that has a similar effect is:

```
10 P% = &C00
20 [PHA:PHA:PHA
30 JSR &C00
40 ]
50 CALL &C00
```

There are many more things that could be demonstrated by this method, and it can be used as a diagnostic aid in machine code programs – you can actually 'see' a program working. It is therefore an extremely useful teaching aid for showing just a little bit of how the Electron and BBC micros work.

Next month: We all know how fast the BBC micro works, but how does it look in slow motion.

Learn a foreign language in twelve hours It's as easy as E

Your BBC Micro can now teach you a foreign language in just 12 hours, via Linkword from Acornsoft.

Linkword is a software series of four language courses—French, Italian, German and Spanish and is ideal for those who want to pick up an elementary knowledge before going on holiday, or for business people who need to acquire the basics in a hurry.

Each 12 hour program is based on a revolutionary new format, making learning enjoyable rather than laborious.

For instance, the Spanish word for bread is 'pan', so you are asked to imagine a pan full of bread and hold that image in your head for 10 seconds.

This method will rapidly enable you to



Language S. BC.

Build up a vocabulary of around 1000 words covering a wide range of useful topics.

Once again, it's another exciting dimension to fulfilling your BBC Micro's potential.

You can order by filling in the coupon opposite. Credit card holders can order by calling 0933 9300 during office hours.

Alternatively, you'll find all four Linkword programs at your local Acornsoft dealer. (To find out where that is, simply call 01-200 0200.)

They come in cassette form, complete with an audio cassette demonstrating the correct pronunciation.

And at just £14.95 each it shouldn't be hard to talk yourself into buying one.

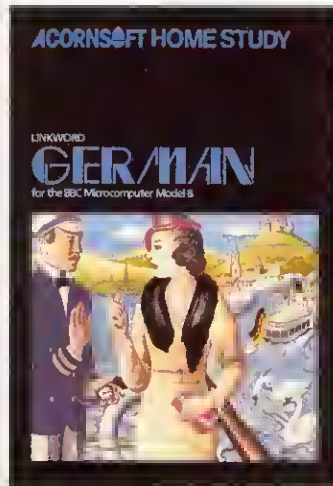

To: Acornsoft, c/o Vector Marketing, Denington Estate, Wellingborough, Northants NN8 2RL.

Please send me the following language software packages at £14.95 each.

PROGRAM	QUANTITY	TOTAL	(Code Acornsoft use only.)
French			SBX13
Italian			SBX14
German			SBX15
Spanish			SBX16
		TOTAL	

I enclose PO/cheque payable to Acornsoft Ltd.
Or charge my credit card.

Card Number _____
Amex/Diners/Visa/Access (Delete)

Please send me details of the BBC
Microcomputer System

Please send me the latest Acornsoft Catalogue

Name _____

Address _____

Postcode _____

Signature _____

Registered No. 1524763

VAT No. 215 8123 85

ACORNSOFT

SLIMLINE PRECISION

These superbly engineered slimline disc drives for the BBC Microcomputer are unsurpassed in quality and accuracy. They feature direct drive brushless D.C. motors and long-life ceramic read/write heads for maximum reliability, and a die cast alloy chassis which gives rigidity and long term stability. Furthermore, advanced chip technology, using large scale integration permits extremely low power consumption to be achieved.

The Pace range includes drives which are switchable between 40 and 80 tracks. Double sided drives give a massive 400K storage per drive in 80 track mode, whilst in 40 track mode they retain compatibility with all commercially available BBC software. All Pace drives will support double density operation.

PACE disc drives are supplied complete and ready to run direct from the BBC's power supply. They are supplied complete with all cables, a utilities disc, and manual. Pace even supply a blank disc so that the drive is ready for immediate use!



Available from your local dealer or direct from:

PACE
Disc Systems

92 NEW CROSS STREET,
BRADFORD BD5 8BS
Tel. (0274) 729306
Telex 51564



Disc drives available:-

SINGLE DRIVES

PSD1	Single Sided 40 Track	100k
PSD2	Double Sided 40 Track	200k
PSD3	Double Sided 40/80 Track	400k
PSD4	Double Sided 80 Track Only	400k
PSD5	Single Sided 40/80 Track	200k

DUAL DRIVES

PDD1	Single Sided 40 Track	200k
PDD2	Double Sided 40 Track	400k
PDD3	Double Sided 40/80 Track	800k
PDD4	Double Sided 80 Track Only	800k
PDD5	Single Sided 40/80 Track	400k

Available from good Computer stores everywhere including:
Computer City, Widnes, Cheshire. Tel. 051 420 333. Computerama, Stafford. Tel. 0785 47899. Computerama, Stoke-on-Trent. Tel. 0782 268620.
Silicon Centre, Edinburgh. Tel. 031 557 4946. G.P.M. Users, Tel. 0532 547474. Wilding Computer Centre, Wigan. Tel. 0942 24362.
National Micro Centre, Stockport. Tel. 061 486 4593. Sh Computers, Cardiff. Tel. 0222 21341. Ethac Computers, Bradford. Tel. 0274 72512.

Put an end to inefficient, slow cassette tape storage



Speed your data access with a TEAC disk drive from Viglen

See our other adverts for 'economy' drives and special offers

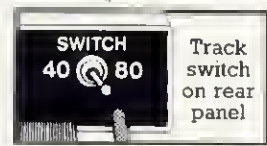

Replacing your cassette with a disk drive means Data Access in less than 5 seconds! If you are looking for a guaranteed disk drive that's fully compatible, at a price that includes VAT, Formatting Disk, User Manual, Case and Leads, then just look at our all-inclusive prices!

When ordering Dual Drives, please state which layout you prefer, A or B.



TEAC 55 Slimline Drives

SINGLE DRIVES CASED	Incl. VAT	Excl. VAT	DUAL DRIVES CASED	Incl. VAT	Excl. VAT
40 TRACK 100K	£143.75	£125.00	40 TRACK 200K	£287.50	£249.57
40 TRACK 200K	£195.00	£169.56	40/80 TRACK SWITCHABLE 400K	£358.00	£311.30
40/80 TRACK SWITCHABLE 200K	£179.00	£155.65	40/80 TRACK SWITCHABLE 800K	£450.00	£391.30
40/80 TRACK SWITCHABLE 400K	£225.00	£195.65	DFS KIT	£109.00	£91.30

- These drives are fully compatible with other computers and can be null used should you change your computer for another type.
- Orders welcomed from Educational Establishments and Government Departments.

TEC DRIVES (As used by Cumana)

	Incl. VAT	Excl. VAT
40 TRACK 100K	£129.00	£112.17
40/80 TRACK 200K	£169.00	£146.95
40/80 TRACK 400K	£209.00	£181.74
Integral Power Supply	£30.00	£26.00

Full Twelve Months Guarantee

How to order

By post: To purchase any of the items simply fill in the coupon with your requirements. Enclose your Cheque/P.O. or use your Access/Barclaycard. Please make cheques payable to: VIGLEN COMPUTER SUPPLIES and post to above address. Allow seven days for delivery and add £8.00 carriage, package and insurance on all items.

By telephone: Ring (01) 843 9903. Credit Card holders (Access/Barclaycard only) can purchase by telephone. Please give Card No., Name, Address and the items required.

Viglen

COMPUTER SUPPLIES

Unit 7 Trumplers Way
Hanwell W7 2QA
Tel: (01) 843 9903

Post to: VIGLEN COMPUTER SUPPLIES UNIT 7, TRUMPERS WAY, HANWELL, W7 2QA

Please send me the following items:

I enclose Cheque/P.O. for £

I prefer to pay by ACCESS/BARCLAYCARD* . Card No. 

Signature _____

Name _____

Address _____

Layout A or B*

Add £8 carriage *Delete as necessary

AU6/1

TRAIN OF THOUGHT

Martin Phillips puts readers on the right track for Train Game

96

Quite a few letters have been passed on to me concerning the *Train Game* published in the January *Acorn User*. The game and the problems associated with it reflect many of the difficulties of all long games listings, brought about by mistakes in typing, lack of experience in debugging and – unfortunately – problems with the program as printed.

First, let's look at the problems connected with the listing itself.

Most of the trouble occurred in the second part of the program, although there were three faults in part one. Two of the faults were corrected on page 8 of the February issue. The first one concerns disc users only. It is the routine to load the second program from disc and then move it down in memory. Unfortunately the version included in February's *Acorn User* does not work and results in the 'Bad program' error. Use the routine below if this is your problem. (This will also cater for Page differences caused by having Econet or Teletext fitted.)

```

630 *KEYO"LOAD""TRAI
NS2""M*T. MF.1%0 TO
TOP-PAGE S.4:1%!&E00=I
%:PAGE=N. M?&13=?&13-(
PAGE-&E00)DIV 256 MPAG
E=&E00 MRUN M"
631 *FX138,0,128
632 END

```

The second correction is included here again and concerns lines 1280 to 1290. This will need to be changed irrespective of whether your machine is tape or disc.

```

1250 DEF PROC SWOP
1260 REM Swop the char set with the
1270 REM user routine space.
1280 FOR I=0 TO &FF
1290 J=I?&C00:I?&C00=I?&900:
I?&900=J
1300 NEXT
1310 ENDPROC

```

The third fault is a minor one. There should be a semi-colon at the end of line 220. It affects only the layout of the screen, not the running of the program.

There are a couple of faults in the second listing. The correct lines are:

```
100 VDU23:8202;0;0;
```

This line deletes the cursor. The semi-colon was missing off the end 0 (as it is in most versions of the handbook). This would not stop the program working as a 12 was included after this last 0 and only this command would have been corrupted. VDU12 clears the screen, but this is not necessary as the previous line was a mode change which automatically clears the screen.

Some of the single quote (') signs in the listing should be £ signs, lines 220 and 440 being affected here.

```

220 VDU31,15,0,17,3:
PRINT"FARES: £";P%;" C
OAL: £";C%;" "

```

```

440 PRINTTAB(0,1B)"F
ARES:£";P%:"COAL:£"
;C%:"LOST:£";TC:"PRO
FIT:£";X

```

On my monitor I found the lettering at the top of the screen difficult to read in white, so I changed the colour to blue. This required changes to lines 220 and 1170 where the 3 following the 17 in the VDU statement was changed to a 2.

Line 2510 reads

```
FOR I=8 TO &FF
```

I suspect it should read

```
FOR I=0 TO &FF
```

However, it seems to work either way.

Some lines have been missed out of the listing yet are referred to in GOTOs and GOSUBs. The simple answer here is to check through the program and make a note of any line numbers that appear to be missing. Then check through the listing to confirm that they actually do not exist (I found several lines I'd missed using this method). Rather than altering several GOTOs and GOSUBs it is easier to put each of these lines in. Simply type the missing line number in, and follow it with a colon. For example:

```
140:
340:
480:
```

Now when you list the program, every line should be present.



The next difficulty seems to occur during the scene-drawing when the 'No room' error appears. The program has run out of space to do its calculations or store new variables. The cure is to shorten the program. If you get the 'No room' error first test the length of the second program by typing:

```
PRINT TOP-PAGE
```

You will almost certainly find that the length of this program is more than 6000 bytes. I found the program does not give the error message if the program is under 6000 bytes long. So how do you set about reducing it? The simplest way is to take out as many spaces as possible. This, however, is fraught with problems for the beginner. If you delete only those spaces indicated below you should make the program short enough.

1. Delete the spaces after the line number. They are not necessary.
2. Delete the spaces after a colon, except where the colon appears inside speech marks, as in line 220 above.
3. Delete the spaces between the VDU statement and any number that follows it.
4. Delete the spaces between any GOTO and a number that follows it.
5. Delete the spaces between any GOSUB and a number that follows it.
6. Delete the spaces between the IF statement and whatever follows it.

If you are in any doubt about whether to delete a space or not, leave it in. There is another place where spaces could be deleted. If you have copied several lines, say to correct errors, then it is easy to copy spaces at the end of the line. These cannot be seen but take up memory space. They can be made visible by changing to mode 6, and redefining the space to be a visible character. The space can be changed into a shaded block using the following:

```
VDU23,32,170,85,170,85,170,85,170,85
```

This should be typed in directly, not included as part of the program, and then the program listed. All the extra spaces become visible and can be edited out. By now it should be under 6000 bytes, and it won't run out of memory.

Having done all this, make one more careful check to see that the program has been typed in correctly. Do this by listing sections of about 10 lines at once (LIST 10,100 etc) and don't check it all at once. Some mistakes are difficult to spot and a break helps the concentration.

Listing 1.

```

10 REM Listing 1
20 TIME = 0
30 MODE1
40 VDU29,640;512;
50 radius=400
60 FOR T=0 TO 1
70 MOVE -radius,0
80 FOR X=-radius TO radius
  STEP 8
90 Y=SQR(radius*radius-X*X)
100 IF T=1 THEN Y=-Y
110 DRAW X,Y
120 NEXT X
130 NEXT T
140 PRINTTIME/100;"sec"

```

Listing 2.

```

10 REM Listing 2
20 TIME = 0
30 MODE 1
40 VDU29,640;512;
50 R%=400
60 FOR T%=-1 TO 1 STEP 2
70 MOVE -R%,0
80 FOR X%=-R% TO R% STEP 8
90 Y%=T%*(SQR(R%*R%-X%*X%))
100 DRAW X%,Y%
110 NEXT X%
120 NEXT T%
130 PRINTTIME/100;"sec"

```

Listing 3.

```

10 REM Listing 3
20 TIME =0
30 MODE1
40 VDU29,640;512;
50 R%=400
55 S%=R%*R%
60 FOR T%=-1 TO 1 STEP 2
70 MOVE -R%,0
80 FOR X%=-R% TO R% STEP 8
90 Y%=T%*(SQR(S%-X%*X%))
100 DRAWX%,Y%
110 NEXT X%
120 NEXT T%
130 PRINTTIME/100;"sec"

```

Listing 4.

```

10 REM Listing 4
20 TIME = 0
30 MODE1
40 VDU29,640;512;
50 R%=400
55 S%=R%*R%
60 FOR T%=-1 TO 1 STEP 2
70 MOVE -R%,0
80 FOR X%=-R% TO R% STEP 8
100 DRAW X%,T%*(SQR(S%-X%*X%))
110 NEXT X%
120 NEXT T%
130 PRINT TIME/100;"sec"

```

Listing 5.

```

10 REM Listing 5
20 TIME = 0
30 MODE1
40 VDU29,640;512;
50 R%=400
55 S%=R%*R%
60 FOR T%=-1 TO 1 STEP 2
70 M VE -R%,0
80 FOR X%=-R% TO R% STEP 20
100 DRAW X%,T%*(SQR(S%-X%*X%))
110 NEXT X%
120 NEXT T%
130 PRINT TIME/100;"sec"

```

Listing 6.

```

10 REM listing 6
15 TIME = 0
20 MODE1
30 VDU29,640;512;
40 S%=400
50 MOVE S%,0
60 FOR A=0 TO 2*PI STEP PI/30
70 DRAW S%*COS(A),S%*SIN(A)
80 NEXT A
90 PRINT TIME/100;"sec"

```

Listing 7. As strings are changed, memory runs out

```

10 REM listing 7
20 CLS
30 DIM A$(99)
40 B$="A"
50 FOR T=1 TO 100
60 FOR N=0 TO 99
70 A$(N)=B$
80 NEXT N
90 PRINTTAB(10,10)"WORKING
   T=";T
100 B$=B$+"A"
110 NEXT T
    
```

Listing 8. The cure

```

10 REM listing 8
20 DIM A$(99)
30 FOR T=0 TO 99
40 A$(T)=STRING$(20,"*")
50 NEXT T
    
```

Listing 9. Steve Ostler's four-colour dump for the Seikosha GP-250X

```

32000 REM Listing 9
32010 DEFPROCtonedump
32020 REM Seikosha GP-250X 4-tone dump
32030 REM for modes 1,4 and 5
32040
32050 DIM pattern 3
32060 !pattern=&0F090800
32070 bottom=82:top=bottom+959
32080 VDU2
32090
32100 REM set line feed to 1/8"
32110 VDU1,27,1,76,1,02
32120
32130 FOR X%=0 TO 1279 STEP 32
32140 FOR split%=0 TO 1
32150
32160 REM select graphics mode,
32170 REM &E0 bytes of data
32180 VDU1,27,1,71,1,01,1,&E0
32190 left=16*split%: right=left+15
32200 FOR Y%=bottom TO top STEP 4
32210 byte1=0: byte2=0
32220 FOR x%=right TO left STEP-4
32230 colour=POINT(X%+x%,Y%)
32240 IF colour<0 THEN colour =0
32250 byte1=byte1*4: byte2=byte2*4
32260 byte1=byte1+pattern?colour MOD4
32270 byte2=byte2+pattern?colour DIV4
32280 NEXT
32290 VDU1,byte1,1,byte2
32300 NEXT
32310 NEXT
32320 VDU3
32330 ENDPROC
    
```

Program 1. Enter as shown

```

0 REM*****
*****
10 FOR I%=0 TO 3 STEP 3
20 P%=&1906
30 OPT I%
40 LDA #138
50 LDX #0
60 LDY #82
70 JSR &FFF4
80 LDY #85
90 JSR &FFF4
100 LDY #78
110 JSR &FFF4
120 LDY #14
130 DEY
140 JSR &FFF4
150 RTS: ]
160 NEXT
170 :
180 REM Auto Run by A Oliver
190 REM Beeb Forum October 1983
200 REM Run this program then type
210 REM DEL.10,230
220 REM now add lines 10 and 20 of
230 REM listing 2
    
```

HOW TO PROCEED

Enter program 1 as shown. Ensure that line 0 contains at least 30 asterisks.

Run the program. An assembler listing will be produced. The machine code produced by this listing will now have been assembled within line 0, overwriting most of the asterisks.

If you list the program you'll see that line 0 contains 'garbage'. We need to keep this line, so delete lines 10 to 230 inclusive by typing

```
DELETE 10,230
```

Now type in the contents of program 2. The final listing should look like program 3. To be able to run this we need to *SAVE it, and to do this we must know the value of TOP so enter:

```
PRINT ~TOP
```

Add 1 to this value and make a note of it.

Now enter:

```
*SAVE "TAPEDIS" 1900 xxxx 1906
```

where 1900 is the value of PAGE, xxxx is value of TOP + 1 and &1906 is the assembled address of the machine code as specified by P% in program 1.

Enter listing 4 and save it with:

```
SAVE "TD"
```

To auto-run the tape to disc copier you can simply enter

```
*TAPEDIS
```

Of course, you could also use CH:"TD".

Program 3. Do not type in. This listing merely shows what the result of listings 1 and 2 should be

```

0 REM*LENTAB(EXTEVALR REMOSCLIEVALU
REMOSCLIEVALN REMOSCLIEVALSTEP) REMOSCL
1 *****
10 PAGE=&1100
20 CHAIN "TD"
    
```

Program 2. Enter after altering program 1

```

10 PAGE=&1100
20 CHAIN "TD"
    
```

Program 4. Enter and save as "TD"

```

10 REM TD
20 REM OSFILE to transfer from tape to disc
30 REM (c) Acorn User June 1984
40 REM by George Hill
40 MODE7
50 HIMEM=&1B00
60 ON ERROR REPORT:PRINT" at line ";LERL:GOTO 250
70 osfile=%FFDD
80 DIM name 9
90 DIM control_block 17
100 control_block%0=name MOD 256
110 control_block%1=name DIV 256
120 Y%=control_block MOD 256
130 X%=control_block DIV 256
140 REPEAT
150 REM Load the file from tape
160 *TAPE
170 *OPT1,2
180 *OPT2,2
190 CLS:PRINT"LOADING FROM TAPE"
200 *LOAD""1B00
210 *DISC
220 PROCsave_file
230 PROCwrite_addresses
240 UNTIL FALSE
250 *TAPE
260 *OPT1,1
270 *OPT2,1
280 *DISC
290 END
300 :
310 DEF PROCsave_file
320 REM Get name and addresses
330 REM A# is name
332 REM B# is length
334 REM C# is load address
336 REM D# is exec address
340 A#=""
350 FOR I%=0 TO B:#A#=#A#+CHR#(I%*7CCB):NEXT
360 REM Retain directory if present
370 IF MID#(A#,2,1) "." THEN A#=#A#+LEFT#(A#,7)
380 #name=A#+CHR#13
390 B#=""
400 FOR I%=14 TO 18:D#=#D#+CHR#(I%*7CCB):NEXT
410 C#=""
420 FOR I%=22 TO 30:C#=#C#+CHR#(I%*7CCB):NEXT
430 D#=""
440 FOR I%=31 TO 38:D#=#D#+CHR#(I%*7CCB):NEXT
450 REM Load A register for file saving
460 A%=0
470 REM adjust block for saving
480 FOR I%=2 TO 17:control_block I%=0:NEXT
490 control_block %8A=#1B00
500 control_block %8E=#1B00+EVAL("#"+B#)
510 CALL osfile
520 ENDPROC
530 :
540 DEF PROCwrite_addresses
550 A%=1
560 control_block %2=EVAL("#"+C#)
570 control_block %6=EVAL("#"+D#)
580 control_block %8A=EVAL("#"+I#)
590 control_block %8E=0
600 CALL osfile
610 ENDPROC
    
```

See 'Leader of the Pack', page 61

Listing 1. How parts 1 to 6 fit together

```

10 MODE1
15 PROC_design
16 PROC_characters
20 FOR card_positions = 1 TO 6
30 READ x_coord,y_coord
40 PROC_draw_card(x_coord,y_coord,7)
50 NEXT card_positions
60 END
500 DATA 360,55,620,55,880,55,360,375,620,375,880,375
600:
900 REM *****
910 REM ** You can use method 1 **
920 REM ** of PROC_print_design **
930 REM ** instead of method 2, **
940 REM ** but remember to add **
950 REM ** line 1065 (which is **
960 REM ** the same as line 1045 **
970 REM ** for method 2 ) **
980 REM *****
990:
1000 DEF PROC_draw_card(x_coord,y_coord,colour)
1010 VDU 24,x_coord;y_coord;x_coord+200;y_coord+290:
1020 GCOL 0,128+colour
1030 CLG
1040 VDU 26
1045 PROC_print_design(x_coord+70,y_coord+170,1)
1050 ENDPROC
1100:
2000 DEF PROC_design
2010 VDU 23,224,170,65,136,20,136,65,160,80
2020 VDU 23,225,170,65,136,20,8,65,130,4
2030 VDU 23,226,170,85,170,85,42,21,10,5
2040 VDU 23,227,168,0,128,0,128,64,160,80
2050 VDU 23,228,2,1,2,85,0,0,0,0
2060 VDU 23,229,168,84,34,81,0,0,0,0
2070 VDU 23,230,128,0,128,0,128,0,128,0
2080 VDU 23,231,128,0,128,0,128,0,0,0
2090 design$ = CHR$224 + CHR$225 + CHR$230 + CHR$8 + CHR$8 + CHR$8 + CHR$10 + C
HR$226 + CHR$227 + CHR$230 + CHR$8 + CHR$8 + CHR$8 + CHR$10 + CHR$228 + CHR$229
+ CHR$231
2100 ENDPROC
2200:
3000 DEF PROC_print_design(x_coord,y_coord,colour)
3010 VDU 5
3020 GCOL 0,colour
3030 MOVE x_coord,y_coord
3040 PRINT design$
3050 MOVE x_coord-10,y_coord+80
3060 DRAW x_coord-30,y_coord+80
3070 DRAW x_coord-30,y_coord+60
3080 MOVE x_coord+80,y_coord-140
3090 DRAW x_coord+100,y_coord-140
3100 DRAW x_coord+100,y_coord-120
3110 ENDPROC
4000:
5900 REM *****
5910 REM ** The next procedure is **
5920 REM ** not used in this **
5930 REM ** program but is still **
5940 REM ** included to be added **
5950 REM ** to any program the **
5960 REM ** reader decides to **
5970 REM ** write **
5980 REM *****
5990:
6000 DEF PROC_characters
6010 VDU 23,232,0,28,28,107,127,107,8,28
6020 VDU 23,233,8,28,62,127,62,28,8,0
6030 VDU 23,234,54,127,127,127,62,28,8,0
6040 VDU 23,235,8,28,62,127,127,28,62
6050 club$=CHR$232:diamond$=CHR$233:heart$=CHR$234:spade$=CHR$235
6060 ENDPROC

```

Listing 1

```

10 MODE1
20 M%=2200:VZ%=-3000:VY%=850
30 DIM Profile%(40),LX%(40),LY%(40),LZ%(40)
40 REPEAT
50 CLS
60 REPEAT
70 INPUT TAB(3,6)"function ",F$
80 UNTIL F$<>""
90 CLS
100 MOVE640,0:PLOT21,640,1023
110 FOR V%=0 TO 40
120 Profile%(V%)=EVAL(F$)
130 IF V%=0 K%=4 ELSE K%=5
140 PLOTK%,640+EVAL(F$),100+V%*20
150 NEXT
160 PRINT TAB(3,8)"continue ? ";
170 A$=GET$
180 UNTIL A$="Y" OR A$="y"
190 CLS
200 REPEAT
210 INPUT TAB(3,4)"pattern ",P$
220 UNTIL P$<>""
230 INPUT TAB(3,6)"X angle ",AX
240 INPUT TAB(3,8)"Z angle ",AZ
250 CLS
260 VDU29,640;1200;
270 VDU19,1,4;0;19,2,6;0;19,3,7;0;
280 FOR S%=-1 TO 1 STEP2
290 FOR H%=0 TO 180 STEP 5
300 AY=90+S%*H%
310 FOR V%=0 TO 40
320 PROCrotateY(Profile%(V%),25*V%-500,0,AY)
330 IF AZ<>0 PROCrotateZ(x%,y%,z%,AZ)
340 IF AX<>0 PROCrotateX(x%,y%,z%,AX)
350 PROCplot(4,x%,y%,z%)
360 IF V%>0 AND H%>0 PROCfacet
370 IF V%=40 GCOLOR,0:PROCplot(5,x%,y%,z%)
380 TX%=LX%(V%):TY%=LY%(V%):TZ%=LZ%(V%)
390 LX%(V%)=x%:LY%(V%)=y%:LZ%(V%)=z%
400 PROCplot(4,x%,y%,z%)
410 NEXT
420 NEXT
430 NEXT
440 END
450 :
460 DEFPROCplot(K%,X%,Y%,Z%)
470 M=M%/(Z%-VZ%)
480 PLOTK%,X%*M,(Y%-VY%)*M
490 ENDPROC
500 :
510 DEF PROCfacet
520 GCOLOR,EVAL(P$)
530 PROCplot(85,TX%,TY%,TZ%)
540 PROCplot(85,LX%(V%),LY%(V%),LZ%(V%))
550 ENDPROC
560 :
570 DEF PROCrotateY(X%,Y%,Z%,A)
580 S=SINRADA:C=OSRADA
590 x%=X%*C-Z%*S
600 z%=Z%*C+X%*S
610 y%=Y%
620 ENDPROC
630 :
640 DEF PROCrotateX(X%,Y%,Z%,A)
650 S=SINRADA:C=OSRADA
660 y%=Y%*C-Z%*S
670 z%=Z%*C+Y%*S
680 x%=X%
690 ENDPROC
700 :
710 DEF PROCrotateZ(X%,Y%,Z%,A)
720 S=SINRADA:C=OSRADA
730 x%=X%*C-Y%*S
740 y%=Y%*C+X%*S
750 z%=Z%
760 ENDPROC

```

V

Listing 2

```

10 MODE4
20 VDU29,640;1200;
30 M%=2200:VZ%=-3000:VY%=850
40 DIMProfile%(40),LX%(40),LY%(40),LZ%(40)
50 REPEAT CLS
60 INPUT TAB(1,4)"Function ",F$
70 UNTIL F$<>""
80 INPUT TAB(1,6)"X rotation ",AX
90 INPUT TAB(1,8)"Z rotation ",AZ
100 CLS
110 FOR V%=0 TO 10
120 Profile%(V%)=EVAL(F$)
130 NEXT
140 FOR H%=0 TO 10
150 AY=H%*36
160 FOR V%=0 TO 10
170 PROCrotateY(Profile%(V%),100*V%-500,0,AY)
180 IF AZ<>0 PROCrotateZ(x%,y%,z%,AZ)
190 IF AX<>0 PROCrotateX(x%,y%,z%,AX)
200 IF V%=0 K%=4 ELSE K%=5
210 PROCplot(K%,x%,y%,z%)
220 IF H%>0 PROCplot(5,LX%(V%),LY%(V%),LZ%(V%))
230 LX%(V%)=x%:LY%(V%)=y%:LZ%(V%)=z%
240 PROCplot(4,x%,y%,z%)
250 NEXT
260 NEXT
270 END
280 :
290 DEFPROCplot(K%,X%,Y%,Z%)
300 M=M%/(Z%-VZ%)
310 PLOTK%,X%*M,(Y%-VY%)*M
320 ENDPROC
330 :
340 DEF PROCrotateY(X%,Y%,Z%,A)
350 S=SINRADA:C=OSRADA
360 x%=X%*C-Z%*S
370 z%=Z%*C+X%*S
380 y%=Y%
390 ENDPROC
400 :
410 DEF PROCrotateX(X%,Y%,Z%,A)
420 S=SINRADA:C=OSRADA
430 y%=Y%*C-Z%*S
440 z%=Z%*C+Y%*S
450 x%=X%
460 ENDPROC
470 :
480 DEF PROCrotateZ(X%,Y%,Z%,A)
490 S=SINRADA:C=OSRADA
500 x%=X%*C-Y%*S
510 y%=Y%*C+X%*S
520 z%=Z%
530 ENDPROC

```

TAPE LOADER

See 'Rapid Retrieval Taped', page 81

Listing 1. 'Loader,' an accurate and rapid search and load routine for tapes

```

10 REM ** Initialisation **
20
30 *TV 255
40 MOOE7
50 LOMEM=TOP+&B0
60 DIM COM% 30:cIi%=&FFF7
70
80 *KEY10 OLD:MRUN:M
90
250 PRINT"" I. LOAD""or 2.
SAVE"
260 ?216=32:PRINT""Choose a number (1
or 2)"
270 ON INSTR("12",GET$) GOTO600,280 EL
SE 270
280 IF PAGE=&E00 THEN PRINTCHR$12:""T
he program to be SAVED must be entered b
efore this LOADER program.""Please st
art again if you wish to SAVE.":END
290 CLS:INPUT""What is the name of th
e program?"PROGRAM$:PROCSAVE(PROGRAM$):
PROCDATA(PROGRAM$):END
300
310 DEF PROCSAVE(PROGRAM$):CLS
320 TP%=(TOP-1):R%=FNC(TP%)
330 RESTORE (1000+R%):READ A$,S%,R%
340 PROCREW
350 PRINT""Check that the tape counte
r is zeroed.""Ready?":PROCYES
360 PROCFF
370 CLS:PRINT""Winding on .... Please
wait.":TIME=0:*MOTOR 1
380 REPEAT:UNTIL TIME>S%:*MOTOR 0
390 CLS:PRINT CHR$7""Press STOP""Is
it ready?":PROCYES
400 CLS:PROCcIi ("SAVE""+PROGRAM$+""
+"E00 "+STR$(PAGE-1)):ENOPROC
410
420 REM **Procedure to record fast-
forward times **
430
440 DEF PROCDATA(PROGRAM$)
450 CLS:PRINT""Carefully note the tap
e counter reading.""Ready?":PROCYES
460 PROCREW:PROCFF
470 PRINT""When the tape counter show
s the end of""the program has been reac
hed press""ANY KEY to stop."
480 R%=FNC(TP%)
490 R%=R%+1:TIME=0:*MOTOR 1
500 G$=GET$:T%=TIME:N$="" +PROGRAM$+",
"+STR$(T%)+", "+STR$(R%):*MOTOR 0
510 N1=(1000+R%) DIV 256:N2=(1000+R%) MO
D 256
5200=LEN(N$)+5:P$=CHR$N1+CHR$N2+CHR$0+
CHR$220+N$+CHR$13+CHR$255:$ (TP%)=P$:PROC
REW:PROCFF
530 CLS:PRINT""Winding on .... Please
wait."
540 TIME=0:*MOTOR 1
550 REPEAT:UNTIL TIME>50:*MOTOR 0
560 CLS:PRINT CHR$7""Press STOP""Is
it ready?":PROCYES
570CLS:Loader$="Loader":PROCcIi ("SAVE"
""+Loader$+""+STR$(PAGE)+"" +STR$(TO
P+LEN(P$)-1))
580 ENOPROC
590
600 PROCLOAD:END
610
620 DEF PROCLOAD

```

```

630 RESTORE 1002:CT%=-1:CLS:PRINT""Pr
ograms on this tape are:-"":TP%=5110:RE
PEAT:TP%=TP%+1:UNTIL?TP%=255:L%=FNC(TP%)
640 CT%=CT%+1
650 FORN%=1 TO 5:READ A$,S%,R%
660 PRINTN%:" "A$":IF R%=L% THEN N%=
6:PRINT""TAB(25)""...That's all."
670 NEXT:PRINT""Type the number of yo
ur choice""or press the SPACE BAR."
680 G$=GET$:IF G$="" THEN GOTO790 ELS
E G%=VAL(G$)+5*CT%
690 IF VAL(G%)>5 OR VAL(G%)=0 OR G%>L%
-1 THEN PRINTTAB(0,23)CHR$136:"Choose on
e of the numbers please!":GOTO680
700 RESTORE(1000+G%):READ A$,S%,R%
710 PROCREW:PROCFF:CLS:PRINT""Winding
on .... Please wait.":TIME=0:*MOTOR 1
720 REPEAT:UNTIL TIME>S%:*MOTOR 0
730 CLS:PRINT CHR$7""Does this progra
m need the maximum""memory available?"
740 IF GET$="Y" CLS ELSE 760
750PRINT""CHR$136"THIS WILL WIPE OUT L
oader"" Do wish to continue?":IF GET$=
"Y" GOTO770 ELSE CLS:PRINT""Press KEY f
0 to try again.":G%=GET
760 PAGE=TOP+&100
770 CLS:PRINT""Press PLAY. ""Is it r
eady?":IF GET$<"Y" THEN 770
780 CLS:CHAIN"":ENOPROC
790 CLS:IF R%<L% THEN GOTO640 ELSE PRI
NT""There are no more on this tape.""
Do you want to try again?":IF GET$="Y" T
HEN GOTO630
800 CLS:PRINT""Try another tape.":END
PROC
810
820 DEF PROCREW: REM ** Rewind **
830 CLS:PRINT""Press the rewind key."
""Is it ready?":PROCYES
840 *MOTOR1
850 CLS:PRINT""Is it fully rewound?":
PROCYES:*MOTOR 0
860 ENOPROC
870 DEF PROCFF: REM ** Fast Forward **
880 CLS:PRINT""Press the FAST FORWARD
key. ""Is it ready?":PROCYES
890 ENOPROC
900
910 DEFPROCYES
920 IF INSTR("Yy",GET$)>=1 ENOPROC ELS
E 920
930
940 DEFFNC(TP%)
950 L$=$(TP%-3):IF VAL(LEFT$(L$,1))=0
THEN =VAL(RIGHT$(L$,1)) ELSE =VAL(L$)
960
970 DEFPROCcIi(cI%)
980 $COM%=cI$:X%=COM%:Y%=COM% DIV 256
990 CALL cI%:ENOPROC
1000
1001 DATA LOADER,1100,1

```

Listing 2. Patch to cure bugs in the OS 0.1 CFS

```

80 *KEY 10 ?&218=&00: ?&219=&0: ?&20A=&
D6: ?&20B=&0: MOLD:MRUN:M
90
100 REM ** 0.5 version 0.1 Patch **
110 FORI%=0 TO 1:P%=&DD0
120 [OPTI%*2
130 .FIX1 PHA:JSR &F521:PLA:RTS
140 .FIX2 CMP#&91:BNE GO:CPX#0:BNE G
O
150 TSX:LOA#102,X: CMP#&F7:BEQ TRAP
160 LDx#0:.TX LDA#&91:STA&FE09:RTS
170 .GO JMP (&DB60)
180 .TRAP PLA:PLA
190 JSR&F9D8:JSR&F878
200 JSR TX:JMP&F7F8
210 INEXT
220 ?&21B=FIX1: ?&219=FIX1 DIV 256
230 ?&20A=FIX2: ?&20B=FIX2 DIV 256

```

Listing 1. Shows how the characters are formed on the screen

```

10 MODE6
20 VDU19;4;0;      Background colour blue
30 M%=%6DC0       Somewhere in middle of screen
40 N%=%C0B0       Character generator in rom
50 REPEAT
60 A=GET          Wait for a key to be pressed
70 ?M%=?N%       Poke another byte into screen ram
80 M%=M%+1
90 N%=N%+1
100 UNTIL A=13    Escape if return key pressed
    
```

Listing 2. Displays the character generator in large block form

```

10 MODE6
20 PROCinit
30 FORM%=%C000 TO %C2FF
40 PROCbyte(M%)
50 NEXT
60 END
70
80 DEFPROCbyte(M%)
90 LOCAL T%,H%
100 @%=6
110 T%=128
120 PRINT?M%,CHR#253;
130 FOR H%=0 TO 7
140 IF(?M% AND T%)>0 THEN
150 T%=T%/2
160 NEXT
170 @%=3
180 PRINTCHR#254,?M%,?M%
190 ENDPROC
200
210 DEFPROCinit
220 LOCAL N
230 VDU19;4;0;23;10,32,0;0;0;
240 N=1
250 VDU23,253,N,N,N,N,N,N,N,N
260 N=128
270 VDU23,254,N,N,N,N,N,N,N,N
280 N=126
290 VDU23,255,0,N,N,N,N,N,0,0
300 ENDPROC
    
```

Listing 4. Displays a bit representation

```

10 BITS%=16
20 *FX16,4
30 MODE6
40 PROCinit
50 REPEAT
60 VDU30
70 FOR N%=1TO4
80 REPEAT
90 UNTIL ADVAL(0)DIV256=N%
100 PROCdisplay(ADVAL(N%))
110 NEXT
120 PRINT" 1234567891111111"
130 PRINT"          0123456"
140 UNTIL 0
150 END
160
170 DEFPROCdisplay(M%)
180 T%=%8000
190 PRINTCHR#253;
200 FOR H%=1 TO BITS%
210 IF(M% AND T%) VDU255 ELSE VDU32
220 T%=T%/2
230 NEXT
240 PRINTCHR#254
250 ENDPROC
260
270 DEFPROCinit
280 LOCAL N
290 VDU19;4;0;23;10,32,0;0;0;
300 N=1
310 VDU23,253,N,N,N,N,N,N,N,N
320 N=128
330 VDU23,254,N,N,N,N,N,N,N,N
340 N=126
350 VDU23,255,0,N,N,N,N,N,0,0
360 ENDPROC
    
```

Listing 3. Displays the bit map and produces a text window on the screen

```

10 MODE 6
20 VDU19;4;0;      Blue background
30 VDU23;12;0;0;0; Make video ram start at page zero
40 ?&34E=0        TeII 0.S. to use pages zero onwards
50 VDU 12         Clear screen
60 VDU 28,0,24,39,14,12 Define a text window to avoid scrolling
70 ?&E00=13;?&E01=255 Prepare to enter a program at &E00
80 FOR I%=%E02 TO &1000 Clear the space
90 ?I%=0
100 NEXT
110 PAGE=%E00     Change PAGE
    
```

MONITORS

See 'Screen Test', page 134

VIII

- Test match: this program puts a monitor through various trials detailed in the main text. See panel for a star rating of each monitor under review for tests A to I

```
10 REM VARIOUS MONITOR TESTS
20 REM ***** MENU *****
30 MODE 7
40 *FX11,0
50 *FX15,0
60 FORV=1TO2:PRINTTAB(5,V)CHR#141CHR
#132CHR#157SPC(3)CHR#134CHR#157CHR#132"M
onitor Tests "CHR#157SPC(4)CHR#156:NEXT
70 FORW=4 TO 5:PRINTTAB(6,W)CHR#134;
CHR#157;CHR#141;CHR#132," MENU";SPC11;C
HR#156:NEXT
80 PRINT "TAB(5)"A... Random lower ca
se letters":PRINTTAB(5)"B... Inverse M's
and W's.":PRINTTAB(5)"C... Flashing B/W
."
90 PRINTTAB(5)"D... Alternating bars.
":PRINTTAB(5)"E... Border line.":PRINTTA
B(5)"F... Circles."
100 PRINTTAB(5)"G... Horizontal colou
r stripes.":PRINTTAB(5)"H... Flashing te
xt.":PRINTTAB(5)"I... Colour test."
110 PRINTTAB(5)"Z...":CHR#131;"END PR
OGRAM":PRINT "TAB(10)"ENTER your choic
e.";
120 ONINSTR("ABCDEFGHIZ",GET#)GOTO 170
,260,370,470,580,630,710,810,920,130 ELS
E VDU7:GOTO120
130 MODE 7
140 END
150 REM ***** THE TESTS *****
160 REM * Random lower case letters *
170 MODE 0
180 CLS
190 FOR NZ=1 TO 2560
200 C=RND(26)
210 VDU C+96;
220 NEXT NZ
230 REPEAT UNTIL GET=32
240 GOTO30
250 REM * Alternating inverse M's and
W's *
260 VDU23,240,156,156,148,148,128,136,
156,255
270 VDU23,241,255,156,136,128,148,148,
156,156
280 CLS
290 MODE 0
300 FOR Z%=1 TO 16
310 FOR Y%=1 TO 40:VDU240,241;:NEXT Y%
320 FOR X%=1 TO 40:VDU87,77;:NEXT X%
330 NEXT Z%
340 REPEAT UNTIL GET=32
350 GOTO30
360 REM * Flashing B/W screen *
370 CLS
380 MODE 0
390 FOR T%=1 TO 15
400 VDU19,2,0;0;
410 FORdelay=1 TO 1000: NEXT
420 VDU19,2,7;0;
430 FORdelay=1 TO 1000:NEXT
440 NEXT T%
450 GOTO 30
460 REM * White bars test *
470 MODE 0
480 VDU23,240,255,255,255,255,255,255,
255,255
490 FOR Z%=1 TO 16
500 FOR C%=1 TO 40
510 VDU240
520 NEXTC%
530 PRINT:PRINT
540 NEXTZ%
550 REPEAT UNTIL GET=32
560 GOTO30
```

```
570 REM * Screen border *
580 MODE 0
590 MOVE2,2:DRAW1277,2:DRAW1277,1021:D
RAW2,1021:DRAW2,2
600 REPEAT UNTIL GET=32
610 GOTO30
620 REM * Solid circle *
630 MODE 0
640 MOVE 740,512
650 FOR C=0 TO PI+PI STEP0.01
660 DRAW640+100*COS(C),512+100*SIN(C)
670 DRAW640+500*COS(C),512+500*SIN(C)
680 NEXT C
690 REPEAT UNTILGET=32
700 GOTO30
710 REM * Horizontal bands of colour
*
720 MODE 2
730 FOR I%=0 TO 1023 STEP4
740 GCOL0,(I%/4 MOD8)
750 MOVE 0,I%
760 DRAW1279,I%
770 NEXT I%
780 REPEAT UNTIL GET=32
790 GOTO30
800 REM * Persistence test *
810 MODE 1
820 *FX9,60
830 *FX10,70
840 VDU19,3,15;0;
850 FOR X%=1 TO 10
860 PRINT"A TEST FOR PERSISTENCE."
870 PRINT:PRINT
880 NEXT X%
890 REPEAT UNTIL GET=32
900 GOTO 30
910 REM * Colour test *
920 MODE7
930 H%=5
940 FOR Y%=2 TO 20
950 FOR I%=1 TO 7
960 B#=STRING$(3,CHR#(&90+I%)+STRING$(
4,CHR#(255))+CHR#(10)+STRING$(5,CHR#(8)
))
970 PRINTTAB(H%*I%-3,Y%)B#
980 NEXTI%
990 NEXTY%
1000 PRINTTAB(0,1);" RED GRN YEL
BLU MAG CYN WHT"
1010 REPEAT UNTIL GET=32
1020 GOTO30
```

Special Offer from Viglen

Complete disc system for the BBC Model B

- Package assumes you own a BBC Model B with switched-mode power supply plus 1.2 Operating System

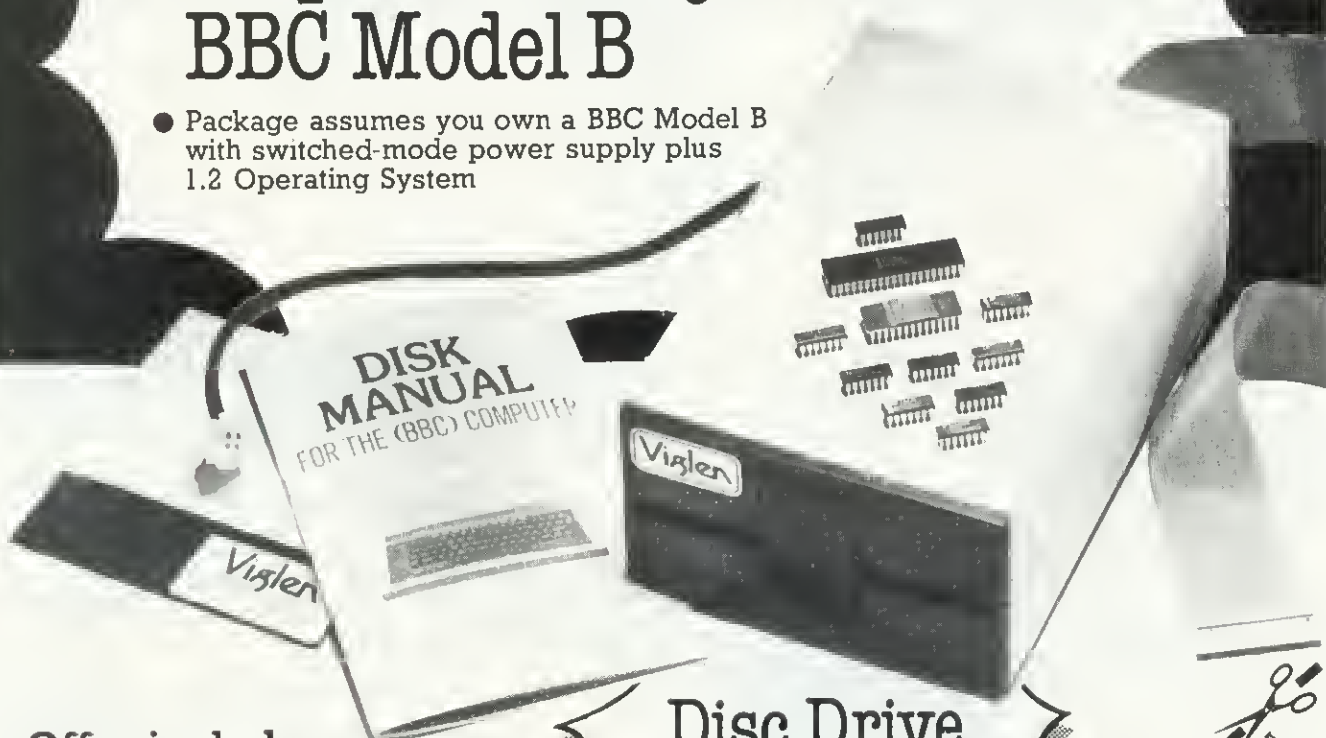

Offer includes:

- 100K full height Olivetti Disc Drive (as used by Acorn), including case and all leads
- Disc Interface (call at factory for a FREE fitting whilst you wait)
- User Guide
- Formatting Disc
- All necessary leads

Disc Drive
and Interface
£199 INC. VAT

Viglen
COMPUTER SUPPLIES

Unit 7 Trumpers Way
Hanwell W7 2QA
Telephone: (01) 843 9903



Post to: VIGLEN COMPUTER SUPPLIES UNIT 7, TRUMPERS WAY, HANWELL, W7 2QA

Please send me (state number required)

I enclose Cheque/P.O. for £

I prefer to pay ACCESS/BARCLAYCARD (Delete whichever not applicable)

Card No. _____
Signature _____
Name _____
Address _____

(Please add £8 for carriage) made out to
VIGLEN COMPUTER SUPPLIES

Credit cards valid if signed
by card holder. Address
above must be the same
as card holder.

AUG/2

Due to a misunderstanding entirely unconnected with Viglen and circumstances beyond Viglen's control incorrect details appeared in the previous issue. Viglen sincerely hope that this time the information in this advert is correct and looking forward to receiving your orders.

INCREDIBLE ANIMATION BROUGHT TO YOUR BASIC PROGRAMS

SIMONSOFT SPRITES VERSION TWO

@ £12.95
for the BBC 32K
NOW AVAILABLE @ £12.95 FOR THE ELECTRON

£15.95 on 40
or 80 track disc



An 18-FOLD INCREASE IN SPEED (BBC) of your own character designs makes this the FASTEST EVER screen movement seen in Basic programs. Amazing animation effects are available at a command, yet no knowledge of machine code is required. This incredible extension to your machine's facilities is RAM based and your whole program can be SAVED/LOADED at the same time as the control routine need take as little as 600 (1.5K) from the memory of your machine!

LOOK AT THESE FEATURES:

- 1. SPRITE GENERATOR PROGRAMS** to create your own sprite designs. All 16 colours may be used in each design, with characters as small as one pixel or as large as the 24 x 24 pixel SUPERSPRITE. As you design the sprites they are automatically stored in the machine code control routine so that you can delete the generator program before writing your own Basic.
- 2. UP TO 48 SPRITES ON SCREEN** with 12 separate designs, each with 3 independently controlled clones.
- 3. INSTANT ANIMATION** with two images in each sprite design. These are switched automatically as the sprite crosses the screen, allowing effects such as hopping frogs, running men, etc.
- 4. COLLISION DETECTOR** with a hit flag that is set to the numbers of any sprite overlapping with the sprite just moved. When the sprites move apart, there is no disruption of the sprite character designs.
- 5. ENLARGEMENT FACILITY** of x2, x3, x4, x5 magnification of the normal size! Let your invaders loom out of the screen in 3-D effects - or use enlarged sprites throughout your program!
- 6. FOUR PRESET FLIGHT PATHS** designed from the generator programs. Each path has 8 definable directions, with up to 255 steps allowed in each direction. Once sprites have been allocated to a path, they will move automatically as your program runs.
- 7. Both EOR and TRANSFER** plotting of sprites to the screen are available.
- 8. A SPRITE LIBRARY** of sprite designs ready for use in your programs with 'books' such as 'GHOSTS' and 'MEN.'
- 9. SPRITE POSITION COORDINATE VARIABLES** which are reset automatically by the control coding. As you move your designs, the 'old' images left behind are deleted automatically.

This amazing package includes control routines containing different combinations of the above features - choose the routine best suited to the program you want to write. A comprehensive colour manual, an introduction program and two arcade style demonstration games are also included in the package. Compatibility with other machines make our animation routines ideal for serious programmers - and we won't claim royalties on programs you market using sprites! N.B. Disc version may be bought on cassette for transference to disc.

SUPERFRUIT @ £5.95 for the BBC 32K £8.95 on 40 or 80 track disc

Simply the best. Full colour high resolution graphics. Spinning reels with 'bounce'. Incredible gamble effects, hold, 3 types of gamble, swap reels, two-way nudge, nudge gambles, coin pile that shrinks/grows, great sound effects. Separate instruction program. This implementation is in a class of its own.

"You would be fully justified in claiming that it is better than the real thing" - M. Field, Oxford.



Actual screen photograph

CASTAWAY @ £8.95 for the BBC 23K The Three Island Adventure

A beautifully designed adventure with a wealth of puzzles of logic and imagination and wit. Tackle beanstalks, irate gardeners and priggish chemistry teachers! Brilliant use has been made of sound and mode 7 graphics with full screen pictures. Set in varied terrain, from sand dunes to mansions, the adventure provides an exciting range of locations through which the castaway must pass in search of priceless treasure and cryptic clues.



Actual screen photograph

ORDERS TO:

**SIMONSOFT, 25 TATHAM ROAD,
ABINGDON, OXON OX14 1QB
TEL: 0235 24140**

PROGRAMMERS - WE PAY 30% ROYALTIES FOR EXCELLENT PROGRAMS

SPELLWISE

IS YORE SPELING REELY ATROSHUS?

Or is it just a littel bit off kei?
In either case you need
SPELLWISE.

NOW ON
DISC
AND TAPE

* is a spelling checker for use with your BBC micro and WORDWISE word processor

* is a DISC or tape based machine code program with comprehensive user manuals

* contains an expandable dictionary of over 6000 words (disc) or 3000 words (tape)

SPELLWISE diligently checks every word in your text against the SPELLWISE dictionary. When it has finished you will be left with a list of words which are incorrectly spelt or not in the base vocabulary.

The program can be interrupted at any stage for inspection of the remaining word list and for the insertion of personal or specialist vocabularies. For this purpose software is included to enable you to create your own data files.

SPELLWISE comprises a set of one disc (or two tapes) plus a complete user manual. The tape version is limited to cassette recorders with motor control.

SPELLWISE costs £12 on tape, £13 on disc and can be obtained from: -

DATAWARE FREEPOST SWINDON SN3 4BR

COILS	CABLES	PVC INS. TAPE	BBC CASS. LEAD
BZYVBB Series	NATS./LOCKS'G	20M. x 12mm wide	3 J Plugs 1.75
CV5V1-C9V1 7p.	L 3.6" W. 1" 3p.	All Cols. 39p.	PVC EQUIP. WIRE
DA90/91 7p.	P. CLIPS WH.NYL	DIET. BOARD	ALL Plain Cols.
IN4002 4p.	3/16" Dia. 3p.	4-Way Blk. 5.79	7/0.2 p/M 5p.
IN4004 4.5p.	1/4" Dia. 3p.	4-Way White 6.24	16/0.2 p/M 7p.
IN414B 2.5p.	1/2" Dia. 4p.	FUSES	24/0.2 p/M 9p.
IN4150 7p.	3/4" Dia. 5p.	20mm Anti-Surge	CLEANING FLUID
		.5, 1, 2A 10p.	T/Heads, PCB's,
TRANSISTORS	LACING CORD	MAINS 1"	Contacts Etc.,
BC184B 9p.	FLAT WAXED NAT	2, 3, 5, 13A 10p.	A'sol Can 1.75
BC184L 9p.	1.2mm x 18mm TK	DIN PLUGS	ANTI-STATIC CLOTH
BF259 30p.	per reel 71p	5pin 1B0 25p.	X Style Brush 65p.
B0131 50p.	CRIMP CONVS	7pin 25p.	STER. H/PHONES
2N2646 85p.	UNINSULATED	JACK PLUGS	Padded 2M Lead
2N3053 55p.	5-1.5mm wire	2.5mm Mono 20p.	20-18KHz 5.76
2N3773 1.95	EYELETS	3.5mm Mono 25p.	TOP-TV AERIAL
TIP110 59p.	2, 4, 6BA 1.2p.	3.5mm Stereo 30p.	7 Element X 2M Lead
T05 PAOS	BUTTS 2p	PVC SCR. CABLE	X Coax Plug 6.95
Blk Ny 1.1.2p.	LOCKING SPADE	4 Core 4 Scrns	IND. SCISSORS
50V. CAPACITORS	3-1.4mm wire	per M. 50p.	Cut Any Material
DISC CERAMICS	4BA 6p.	JACK SOCKETS	L 140mm 3.70
0.01mfd 6p.	1.5-2.5 wire	Chasis Mtg.	L 190mm 4.00
0.1mfd 9p.	4BA 5p.	2.5, 3.5mm 20p.	I.C.'s
RESISTORS	TIN COP. WIRE	DIN SOCKET 180	324 60p.
CARBON FILM	200gm. Reels	5pin Chas. 25p.	555 43p.
25W.5% H.S.	16, 18swg 1.56	5pin Line 30p.	710 61p.
10R-10M 2p.	20, 22swg 1.61	ADHESIVES	741 1.00
TW.ROC 6W.WE.	24swg 1.77	3.5gm Twin Pk.	747 72p.
10R-1M 6p.	M'CORE SOLDER	EPOXY RESIN 25p.	7400 31p.
RIBBON CABLE	500gms Reel	2gm Super Glue 95p.	7474 42p.
RAINBOW per M.	22g 60/40 7.40	EPSON RIBBON	74121 52p.
10 WAY 75p.	MAINS PLUG	74LS123 97p.	74LS393 1.20
20 WAY 1.45	13amp 49p.	MX/RX/FX80 4.50	

D N DISTRIBUTION

72 WOOD LANE, CHIPPENHAM, WILTS. SN15 3DT. TEL: 0249 650207

All Products. FIRST GRADE. FULL RANGE Price List on Request. All in-stock Items Despatched the SAME day. Official Orders welcomed from Govt. Depts., Schools, etc. CASH with Order, Please ADD 60p p&p, then ADD 15% VAT. Cheques payable to D N ELECTRONICS.

VIGLEN

branches out

to offer the best value in monitors & printers

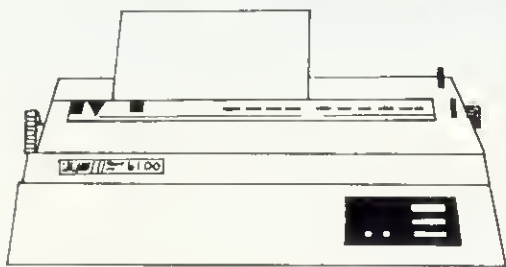

PRINTERS

Daisy Wheel—JUKI 6100

Daisy wheel printer 18 cps: bi-directional & logic seeking. 10, 12, 15 cPl & proportional spacing up to 220 characters per line. 2K Buffer, incl. cables **£389.00** inc. VAT

NEW SPECIAL OFFERS

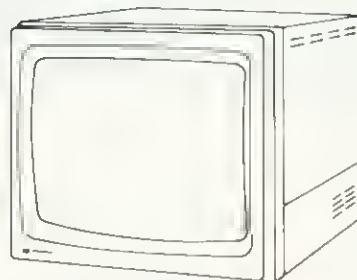

MICROVITEC Microvitec 1431

14" Std-Res **£199.95** inc. VAT
Med-Res **£340.00** inc. VAT
Hi-Res **£442.00** inc. VAT

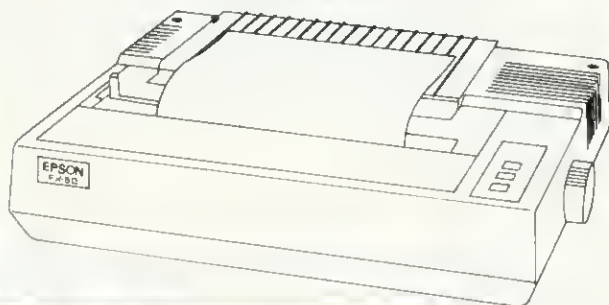

QUALITY DOT MATRIX

Epson FX80 F/T. Now Prints at a speed of 160 characters **per second!** Remarkable range of facilities. Italics, proportional spacing, user downloadable characters and a lot more. Beautiful graphics. Friction feed as well as tractor feed. **£379.00** inc. VAT

Epson RX80 F/T. A most reliable printer at a realistic price. Offers 100 characters per second. Friction feed as well as tractor

feed. **£289.00** inc. VAT

COMPLETE WORD PROCESSING PACKAGE

BBC Model B fitted with DFS & View, Green Monitor, Daisy wheel printer, disc drive, manual & Formatting disc, and all necessary leads. **£1200.00** inc. VAT

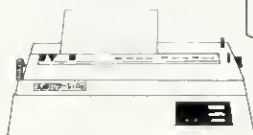
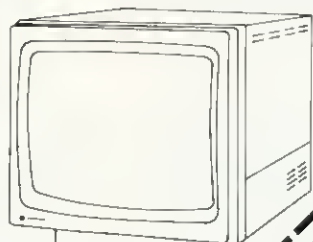

Post to: VIGLEN COMPUTER SUPPLIES UNIT 7, TRUMPERS WAY, HANWELL W7 2QA

Telephone: 01-843 9903. Personal Callers Welcome.

Please send me (state number required)

I enclose Cheque/P.O. for £ _____ Incl. £8 carriage. Cheques payable to Viglen Computer Supplies.

I prefer to pay ACCESS/BARCLAYCARD (Delete whichever is not applicable)

Card No. _____

Signature _____

Name _____

Address _____

Credit cards valid if charged by card holder. Address below must be the same as card holder.



electron Users:

THE ONLY ADD-ON YOU NEED EVER BUY

THE SIR PRINTER/ADC INTERFACE

- ★ NOT JUST ANOTHER JOYSTICK PORT – FULL ANALOGUE- TO -DIGITAL CONVERTER provides fully proportional control, essential for use with graphics packages, digitizers, etc; ideal for scientific & educational applications; usable with a wide variety of BBC Micro-compatible analogue and switched Joysticks/Paddles; complete compatibility with ALL currently-available software.
- ★ CENTRONICS PRINTER INTERFACE – allows use of a wide variety of parallel printers including entire Epson range/ complete firmware support included.
- ★ HIGH-QUALITY MOULDED CASE – attractively styled plastic unit bolts securely to the back of the computer.
- ★ EASY TO FIT – no soldering, simply plugs straight into computer's rear edge-connector and is held in place by twin bolts; edge-connector on back of unit provides for further modular expansion if necessary.
- ★ THE SIR ELECTRON PRINTER/AOC INTERFACE £65.95

ALSO
AVAILABLE

THE SIR ELECTRON ROM/RAM EXPANSION BOARD

- ★ Provides 12 extra sockets which support a variety of ROM and RAM configurations up to a max of 192K for ROM and 16K for RAM.
- ★ ROM and RAM is normally paged in 16K blocks but is easily switchable to 2K, 4K or 8K blocks.
- ★ Price £59.95
- ★ Easy to install – just plugs in.
- ★ Professional styled casing bolts to rear of computer.
- ★ Fully buffered design.
- ★ Permits use of most BBC ROM-based software including utility ROMs, word-processors & languages.

FOR THE
BBC MICRO

THE SIR ROM/RAM EXPANSION BOARD

- ★ 12 extra ROM sockets complement those already provided by the micro to allow up to 256K ROM space.
- ★ Four of these sockets can support either ROM or Static RAM (up to 16K maximum RAM).
- ★ The Model 2 board allows switching between multiples of 2K, 4K, 8K or 16K ROM/RAM.
- ★ Fully compatible with all ROMs, including LDOS, Aries B20, and TORCH ZB0 2nd processor card.
- ★ NO soldering, plug-in design.
- ★ Fits easily inside BBC case.
- ★ Plugs into CPU socket via short flexible connector.
- ★ Improved plug design allows the Model 2 board to connect securely to any type of BBC CPU socket with no harm to micro on board.
- ★ Board is held in place by sturdy supports..
- ★ Full instructions provided.

SIR BBC MICRO ROM/RAM EXPANSION BOARD (Model 2): PRICE £40.00 + VAT

All our prices are inclusive of VAT unless stated otherwise.

Postage and Packaging:

POST FREE (small items: ROM Boards, etc.);
£10 P&P (large items: Printers, Monitors, etc.);
Access/Barclaycard Telephone orders welcome.

SIR COMPUTERS Ltd.
91 WHITCHURCH ROAD, CARDIFF CF4 3JP.
Telephone: CARDIFF (0222) 621813



INTRODUCING THE TEAC 3" DISC DRIVE

Single 100K £159 inc VAT + £8 carriage
Cased, and price includes cables, utilities disc and manual.

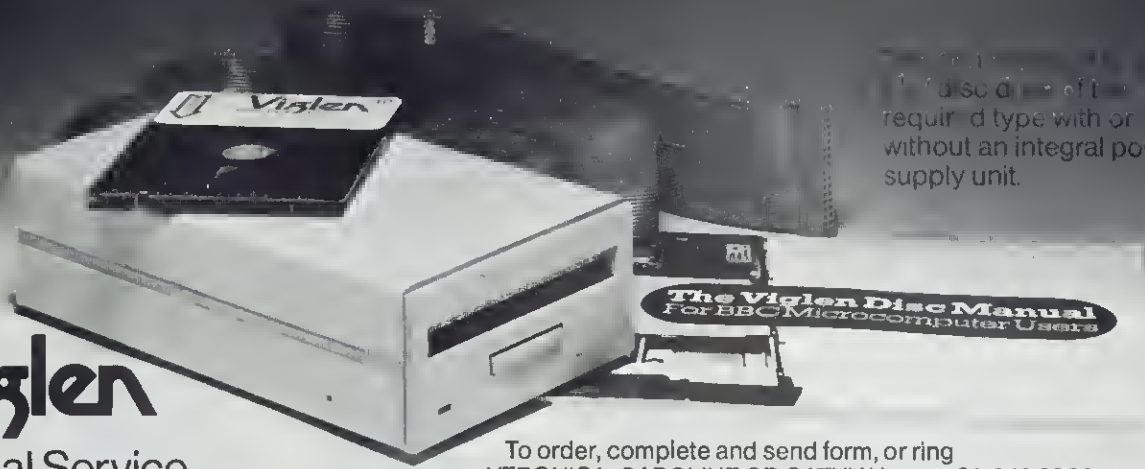

The **Viglen**
Special Service

To order, complete and send form, or ring
VERONICA, CAROLINE OR CATHY Now on 01-843 9903

Post to: VIGLEN COMPUTER SUPPLIES, UNIT 7, TRUMPERS WAY, HANWELL, LONDON W7 2QA.

Please send me _____ (qty) TEAC 3" Disc Drive at £159 each + £8 carriage. I enclose Cheque/P.O. for £ _____

made out to VIGLEN COMPUTER SUPPLIES or debit my ACCESS/BARCLAYCARD No. _____

Name _____ Signature _____

Address _____

THE TOTAL COMPUTER CONSOL !

Ideal for home, school or business!

This unique total control consol has been individually designed to help you keep your hardware clean, tidy and safe! No more messy wires, no more fear of damage or hesitation in transporting from one place to another. Just look at the features incorporated as optional!

Simply choose the type you wish to purchase or we will construct to your specification!



Just look how everything fits into place!
(Monitor, Disc, Dual Disc Drive, Hard Keyboard for preference etc.)



From **£34.50**
plus P & A

(Consol size: 21cm x 21cm x 40cm - Cabinet matches to the BBC Micro)

You may purchase the consol that suits you most, by salary adding the extras you wish to use fitted. Read the caption carefully and simply add the equivalent cost per item listed.

HOW TO ORDER

BY POST
To purchase your special consol simply fill in your requirements on the order form and return to Viglen Computer Supplies. Make cheques/P.O. orders to VIGLEN COMPUTER SUPPLIES and send to the address below.

BY TELEPHONE - (01) 843 9903
Credit Card Holders: Access/Barclaycard only can purchase by telephone. Please give Card No., Name, Address and Item required.

IN PERSON
Should you wish to visit us, please do. The nearest tube station is 'BOSTON MARCH' (Piccadilly Line).

WE GUARANTEE DELIVERY WITHIN 48 HOURS
(Subject, of course, to your being responsible.)

DEALER INQUIRIES WELCOME!

THE FOLLOWING TABLES SHOW THE EQUIVALENT COST OF THE CONSOL WITH THE FOLLOWING EXTRAS:

EXTRAS	UNIT	VAT	TOTAL
MONITOR (10" or 12" size)	120	12	132
KEYBOARD (10" or 12" size)	80	8	88
DISC DRIVE (10" or 12" size)	159	16	175
POWER SUPPLY (10" or 12" size)	110	11	121
TELEPHONE (10" or 12" size)	110	11	121
DISC DRIVE (10" or 12" size)	159	16	175
POWER SUPPLY (10" or 12" size)	110	11	121

I am free to purchase this by telephone with my VISA/BARCLAYCARD (Access/Barclaycard only can purchase by telephone).

Unit No. _____
Serial No. _____
Name _____
Address _____
City _____
Postcode _____
Tel No. _____

Send with 1 pound in cash to: Viglen Computer Supplies, Unit 7, Trumpers Way, Hanwell, London W7 2QA.

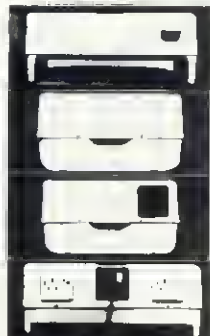

Front
MONITOR/KEYBOARD
This is ideal when the unit is being used in a room. It is also ideal for TV rooms and computer rooms etc.

Left
MONITOR/KEYBOARD
Control wires for switches and socket.

Right
MONITOR/KEYBOARD
This is ideal when the unit is being used in a room. It is also ideal for TV rooms and computer rooms etc.

Back
POWER SUPPLY/KEYBOARD
This is ideal when the unit is being used in a room. It is also ideal for TV rooms and computer rooms etc.

Viglen
COMPUTER SUPPLIES
VIGLEN COMPUTER SUPPLIES
UNIT 7, TRUMPERS WAY, HANWELL, W7 2QA
Tel: (01) 843 9903

TEC from VIGLEN As used by Cumana

BBC Compatible Disc Drive systems at

HALF

HEIGHT

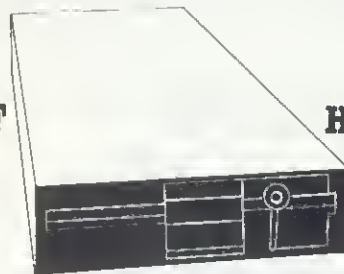

TEC Single sided 40 track 100K 5 1/4"

Disc Drive £129 inc VAT

TEC Double Sided 80 track 400K

5 1/4" Disc Drive £189 inc VAT

All disc drives come complete with Professional Case · Ribbon cable to connect to BBC Micro · Power cable to connect to BBC Micro · Comprehensive Manual · Formatting and utilities disc.

Post to: VIGLEN COMPUTER SUPPLIES UNIT 7, TRUMPERS WAY, HANWELL, W7 2QA
Telephone: 01-843 9903 Personal Calls Welcome
Please send me (state number required) _____
I enclose Cheque/P.O. for £ _____
I prefer to pay ACCESS/BARCLAYCARD (Please indicate which ever is not applicable)
Card No. _____
Signature _____
Name _____
Address _____

AU 514



DOWN TO BUSINESS

Should you computerise?

Barry Pickles talks you through the early decisions

SO YOU'RE thinking of using a computer for your business? Before you commit yourself, you need to answer five basic questions:

1. Do I really need a computer?
2. What will it/they be used for?
3. How will it affect current working practices?
4. Which software packages most readily fit my needs?
5. Which computer should I use?

In the normal scheme of things, the choice of computer is the last thing that needs to be considered, because your choice will be determined by those machines capable of running your chosen software. However, as you are reading this article, I can safely assume that you are already thinking in terms of the BBC micro; perhaps you have one at home and are looking for suitable ways in which it can help your business. But let's not get ahead of ourselves. The first thing you need to decide is whether a computer can help you at all.

The answer is almost invariably 'Yes'. Microcomputers are useful to a businessman in many ways. Two obvious applications are word processing and financial planning/modelling and, if you look through our back issues, you will find reviews of various such packages available. I would also recommend that you read the articles 'Busi-Beeb' and 'Down to Work' in *Acorn User*, September 1982.*

Whether you can use a computer in more complex ways depends upon your particular situation. Just because you use

a computer, it doesn't mean that your work will be done more efficiently or cost-effectively. With the advent of the Z80 second processor, much more business applications software should become available through the use of the C/PM operating system – however, as with Basic, there is no such thing as a standard implementation.

Unless you are a sole trader – and particularly if you have little experience of computers – you must consider the effect that a computer may have on your current working system and on your employees. Everyone has his own way of approaching a task and the introduction of a computer system, especially one using off-the-shelf packages, can come as a severe shock. Ideally, the software should, as nearly as possible, approach the task in the manner you use at present. If it doesn't, you may be faced with expensive re-training bills or even the possibility that a loyal member of staff will leave you because of his or her inability to work with

the system. At best, some retraining will be involved. Also, you will have to enter your existing files into the system, which in itself can be a severe headache.

The choice of software will be limited by what is available for your system and what best suits your working arrangements. The choice of computer is already assumed. As it happens, the BBC micro can be of considerable help, thanks to its sheer versatility and expandability. The minimal system you will need will comprise a monitor (TVs are not good enough for business use), a printer and at least one disc drive, though two would be preferable. (Unless you are preparing documents purely for internal consumption, the printer will have to be of letter quality.)

Having got thus far, you are ready to begin final planning. It is at this stage that you should seek professional advice, either from a consultant or from one of the regional offices of the National Computer Centre†. They will talk the whole thing through with you and should have some appropriate packages for you to look at and try. Your local dealer may also let you try out packages, but the time he is prepared to allow you will depend, in many cases, on how much business he anticipates getting from you. If some of your staff will be working with the final implementation, it is a good idea to involve them at this stage. Their views are likely to be less euphoric than yours and they will feel much happier about the whole scheme if they have been involved in its conception.

You may benefit from taking a short

*Back numbers of *Acorn User* are available from the Subscriptions Dept, Redwood Publishing, 68 Long Acre, London WC2E 9JH, price £1.25 inclusive.

† Currently the only professional body for computer people in the UK is the British Computer Society. While membership is no guarantee, it does imply a certain standard. The BCS will put you in touch with a local consultant member. The address is 13 Mansfield Street, London W1M 0BP (01-637 0471). The National Computing Centre has a network of regional centres, where you can seek advice. These centres have workshops in which you may try out various packages. Initial contact is free of charge. The NCC is at: Oxford Road, Manchester 1 (tel: Freephone 3615).

course in business computing. A number are usually advertised in the computer press, but you may well find that your local adult education authority runs courses locally. You will learn some of the things to avoid and gain hands-on experience.

Before rushing out with your cheque-book, plan the conversion process carefully. Write down all the stages that you will have to go through and set yourself rough targets. It is unlikely that you will be able to meet them, but it gives you something to measure your progress by.

When you come to purchase the equipment, don't forget maintenance. Computers, and especially their peripherals, can go wrong, so consider the effect of this on your workflow. Mainframe installations usually have engineers on call 24 hours a day but you are unlikely to find this level of service on a micro and, if

you do, it will not come cheap; sort this out with your dealer at the time of purchase. Implement the system in stages, the simpler applications first, and thoroughly test each application before you commit yourself irrevocably. If possible run the manual system in tandem for a while. A good starting point is to set up a word processing system to help you get used to handling discs, controlling a printer and generally organising a 'work station'.

Finally, here are two golden rules, lessons learned from almost 20 years' experience in using computers in business:

- **COMPUTERS BREAK DOWN.** Usually, at the most inconvenient time. Try not to put yourself in a situation where you are totally dependent upon the machine to carry out your business activities.

- **PERIPHERALS DO GO WRONG.** Make it a rule that every day you will make back-up copies of all the files used that day. That way, you will have only lost one day's work if something goes wrong. Back-ups should be stored elsewhere from your normal place of work, in case of fire.

- **PEOPLE ARE HUMAN BEINGS.** And they don't like their normal routines being mucked about with! Considering the versatility of computers, I am amazed by the number of systems which require staff drastically to revise their working methods to fit in with The Computer. Involve staff and try to keep changes to a minimum.

OK, so that's three rules, but then things never turn out quite as you expected. Computerising a business is a serious matter, requiring careful thought.

VIRTUES OF SIMPLICITY

Barry Pickles compares the invoicing and mailing list packages published by Acornsoft and Gemini

'Invoicing' and 'Mailing List', Acornsoft, £24.95 each.

'Invoicing & Statements' and 'Mailing List', Gemini, £23.85 each.

THE two pairs of packages reviewed here from Acornsoft and Gemini are each part of a whole suite of packages produced by these houses, designed to cover the 'paperwork' tasks that most small businessmen find onerous. The Acornsoft packs form an integrated package; that is, data created by one can be used by others. The Gemini packs are not integrated.

Turning first to the Acornsoft pack for *Invoicing*, this comes in a smart case with manual, the first half of which deals with the handling procedures for data files and is common to all the other manuals. The second half covers the package in use and gives adequate information, but it is not the most comprehensive documentation I have encountered. All packs are on 40-track, single-sided disc only (although it doesn't say this anywhere in the packaging) and if you use 80-track you need to write to Acornsoft to find out how to adapt the pack (Acornsoft says it wasn't possible to do the 40/80-readable discs because of lack of space on the disc). Each pack also requires its own data disc (or two, if you are sensible and back-up everything).

The disc auto-boots and you then have to set up system parameters. This means telling the system whether you are using single or twin drives and what other packages you have from the same series.

If this is the first use of the system you create a data disc, following the prompts. Here is the first hurdle, for the disc is first referred to as the Data disc but is subsequently called by a different name (which depends upon which pack you are using). This leads you to suppose, incorrectly, that it refers to a different disc and, if you are using a twin drive system, you will not have even removed the Data disc!

Now you move on to creating the various files your system will need. The files are created with a fixed record length, and space is reserved on the disc by creating a dummy file, which is subsequently overwritten by real data. This requires you to guess how many records you'll need and you are advised to err on the low side, since a large file cannot be made smaller, but a small file can be made bigger (more of this anon).

You are presented with the record screen for you to input the required data. Most fields are mandatory and some will accept only numeric data. There is full error-checking, so you can't get it wrong. The first thing you notice is that the address field is limited to three lines. The second thing is that, if you make a typing mistake and you have already pressed Return, you are given the option at the end of each screen to proceed or not. Taking the latter course, the entire record is wiped out and you must do the whole thing again. This is particularly disconcerting at the end of the second screen, since *both* screens are erased!

You may encounter another quirk with the optional field for the (customer's)



purchase order number. If you ignore it and just press Return, all is well; but if you input some data, pressing Return returns you to the menu screen and – yes, you've

guessed it – the entire record is wiped out! One way round this is to save the file with any mistakes, load it back in and then use the AMEND function provided, which gives line-by-line editing. But why not do this as the data is inserted?

From here, you next set up your VAT classifications, five in all. This is straightforward, but I would have liked to have an E (for exempt) class, rather than purely numeric fields.

Now you are ready to produce an invoice. You have the option to preview any invoice in 80-column mode, without printing. However, you find that to do this you need to copy a file from the program disc to the data disc. To be fair, the manual tells you this, but why it wasn't automatically copied at the system set-up stage I do not understand. If you've forgotten to do it, you must quit the program, copy the file, then re-enter and work your way down through the various levels.

The program is modular and there are various levels – pressing Escape returns you to the menu or the next highest level.

Print out your invoice(s) – and here is your next shock. The invoice layout is fixed and the print type is that of the default setting of your printer. A sample invoice is shown in figure 1 and you will see from this that, as well as being restricted to A4 format, any pre-printed stationery you have cannot be used. Even worse, the company name header is not even properly centred.

Having accepted the foregoing, you will sooner or later want to make your files larger. To do this, you select the EXTEND option and follow the prompts. Again, the error-checking is first-rate and you cannot inadvertently insert the wrong disc. However, when we tested it, it required no fewer than 24 disc changes to accomplish. This was using only two of the possible seven packs and on a twin-drive system. How often you will have to do this depends on your business, but it takes ages and a lot of clicking and clunking on the disc drives.

Most of what I've said so far also applies to the *Mailing List* program (and, presumably, the rest of the series). It is simpler to use, with options to have a selective mailing, based on four classification types. Again, however, there is no print-style option and no formatting. Neither can you use labels set across the page, since it prints them only vertically. You are permitted only one copy of each label (unless you return to the menu each time) and they are automatically printed in supplier number order – and will continue printing until you get to the end of the file or press Escape. It is a simple pack, the kind of program that could be written by any competent ten-year-old and does not justify its price, apart from its ability to interact with other packs.

By the way, none of these packs works with the Watford DFS.

After all this, turning to the Gemini packs came as something of a relief! The packs come in a less flashy package, again with a manual. They are compatible with the Watford DFS and can be supplied in 40 or 80-track format.

The manuals are clear but are hardly needed since there are prompts galore. In fact, the first time I used it, I didn't refer to the manual yet managed to produce a document within five minutes.

Because these packs are not integrated you'll need to recreate data for each one that you use. However, they are written at a much simpler level, and perhaps because of this, do their job much more satisfactorily. There are various options. The *Invoices & Statements* pack allows: Print or Report; Statements or Invoices (you need a separate pack to produce statements with the Acornsoft system); Inspect files; Save; Add footer message(s). This last option puts messages (rude or otherwise) at the foot of the invoice. Again, the invoice format is fixed, but you have print options.

The *Mailing List* pack options are: Add record; Alter record (no bugs here!); Sort; Browse (exactly that, backwards or forwards); Find; Delete; Save; Print. Again, there are some print options allowing use of multi-header labels and you specify how many of each you want to print and where printing is to start and stop. There is no limit to the number of lines you may have. Again, screen prompts abound and

it's simple enough for a child to use.

The integration technique provided by Acornsoft is potentially very useful, but I dislike the way it has been done. There is no doubt that the Acornsoft packs are very clever, but they appear to have been written by a programmer who knows little about business, rather than by a businessman who knows something about programming. In trying to be all things to all people, they have become too complex and would be unworkable in my business.

The Gemini system, on the other hand, doesn't try to be too clever. It just does the job – simply and competently. It works in a manner that any book-keeper would be able to master in no time at all and, if you are prepared to accept the restrictions of a standard-layout invoice, it will be quite at home in a small business environment.

Figure 2. Labels output from Gemini's mailing list software

```

KEYREF :FIL/SEARCHKEYS*****
*****Name*****
*****Title*****
*****Company*****
*****Address (1)*****
*****Address (2)*****
*****Town/City*****
*****County*****
*****Post Code*****

KEITH PARSONS
DIRECTOR
NOLENE CARPETING
12 MAGDALEN ROAD
HEAVITREE
EXETER
DEVON
EX7 4HR
    
```

I N V O I C E						
ABC TRADING CO LTD COMMERCIAL BUILDINGS BANK ROAD BURY, LANCs BB7 7XY						
VAT REG. NO. AD1234						
Date 15/4/84			Order Date 10/4/84			
Billed To: Johnsons Super Stores Ltd 25 Riverside Lane GLOUCESTER GL2 7YZ			Sent To: Johnsons Super Stores Ltd 25 Riverside Lane GLOUCESTER GL2 7YZ			
Order No: 1	P.O. No: []		Page 1		Invoice No: 2	
Product	Description	U.P.	Qty.	Disc.	Ex. Price	VAT
1	BLANK DISCS.....	2.50	10	5.00	23.75	3.56
4	PLUGS.....	0.70	20	0.00	14.00	2.10
2	CASSETTES.....	0.25	50	0.00	12.50	1.88
7	DISC DRIVES (100K)..	145.00	2	5.00	275.50	41.32

VAT	Rate	Net Amount	VAT Amount	Net Total: 325.75		
0	0.00	0.00	0.00	:		
1	15.00	325.75	48.86	:		
2	25.00	0.00	0.00	VAT: 48.86		
3	12.50	0.00	0.00	:		
4	0.00	0.00	0.00	:		
Total:			48.86	TOTAL: 374.61		
TERMS 10 days						

Figure 1. Sample invoice from Acornsoft's invoicing pack

TOOLKIT ROM



Basic Programmer's Aid for the BBC Micro from
BEEBUGSOFT

*it is possible to program in Basic
without TOOLKIT but it's not very smart*

"TOOLKIT is an essential utility for all Basic programmers using the BBC Micro. . . . The range is enormous. . . . An indispensable aid packed full of powerful utilities."

Educational Computing, March 1984

"... Should speed up the process of programming considerably. . . . TOOLKIT is highly recommended."

PCN, March 17, 1984

TOOLKIT is an indispensable aid to Basic programming on the BBC Micro. It gives instant access to a set of powerful utilities held in ROM.

These will get you out of trouble like the *RECOVER, or just make life much easier, like automatic listing of error lines, search and replace, list variables, procedures . . . etc.

TOOLKIT features an extremely powerful editor, allowing the use of cursor keys to list a program line-by-line in either direction and move to any part of a program to overtype or insert new code and corrections.

TOOLKIT also contains a powerful facility to trap an error in a Basic program as it runs. It will then automatically enter the Screen Editor, display the line in error and position the cursor at the statement at fault.

COMMANDS

*CHECK	Verify a program or data in memory with disc/cassette.
*CLEAR	Clear all variables including integers.
*EDIT	Enter full screen editor.
*FREE	Display free memory and pseudo variables.
*HELP INFO	Displays various useful system information.
*MEMORY	Display memory contents.
*MERGE	Merge two programs.
*MOVE	Move program to run at specified address.
*NEW	As New, but can be issued from within a program.
*OFF	Cancel enhanced error handling.
*OLD	As Old, but can be issued from within a program.
*ON	Auto error handling - enters editor at line in error.
*PACK	Efficient program compactor.
*RECOVER	Intelligently recover bad programs.
*RENUMBER	Allow partial renumbering.
*REPORT	Extended error reporting facility.
*SCREEN	Screen dump to cassette or disc.

*UTIL 1	String Search
*UTIL 2	String Search and Replace.
*UTIL 3	Move Basic program lines.
*UTIL 4	List Procedures and Functions.
*UTIL 5	List values of A% to Z%.
*UTIL 6	List Numeric Variables.
*UTIL 7	List String Variables.
*UTIL 8	List Names of Arrays.
*UTIL 9	Set up range for Utilities 1 and 2.

- Just Plug it in, no loading necessary
- 27 new commands to make life easier
- Saves hours in program development and debugging
- Supports both cassette and disc systems
- No command name conflict with other Roms
- Ideal for expert and novice alike
- Fitting instructions and a 32 page manual supplied
- You'll wonder how you ever managed without it

Available from your dealer and selected branches of WH SMITH

£27.00

Including
VAT & pp



BEEBUGSOFT, PO BOX 109, HIGH WYCOMBE, BUCKS.
Toolkits at £27.00 each

Please send me
Name _____
Address _____

Send cheque/postal order to
BEEBUGSOFT, Dept 13, PO
Box 109, High Wycombe,
Bucks.

BEEBUGSOFT is the Software house of BEEBUG Publications Ltd.

THE MIDDLESEX CENTRE FOR BBC

Everything for the Acorn/BBC Owner under one roof.

ACORN ELECTRON - £199 BBC MODEL A - £299
BBC MODEL 'B' - £399

Disk Drives by: TEAC, MITSUBISHI, AMS, CUMANA, KORMANDI, TORCH and others from £169.00

Monitors by: NOVEX, PHILIPS, MICROVITEC, FIDELITY from £79.95

Printers from EPSON, STAR, BIT, SHINWAH, BROTHER, JUKI, UCHIDA etc, etc from £89.95

Accessories: Lightpens, Dust Covers, Joysticks, Monitor Stands, Cases, Leads, Floppy Discs and much much more

SOFTWARE: GAMES, BUSINESS & EDUCATIONAL plus PROGRAMMING AIDS on Cassette, Disk or Rom.

UPGRADES, ROM FITTING, REPAIRS, TESTING etc, etc

PLUS!

Special Word Processing, Business and Programming starter Kits offered to meet your requirements at good savings.

WE WILL BETTER ANY GENUINE OFFER IF THE PRICE IS LOWER THAN OURS

SCREENS MICROCOMPUTERS

(A Division of Mayfair Computer Services Limited)

6 MAIN AVENUE, MOOR PARK, NORTHWOOD, MIDDLESEX, ENGLAND.
 Tel: NORTHWOOD (09274) 20664

- ★ Open 6 days per week. Easy Parking.
- ★ Worldwide fast, reliable mail order.
- ★ Official Orders/Enquiries welcome.

Visa . Access . Amex . Diners Club . Instant Credit



BBC/ELECTRON PROFESSIONAL SOFTWARE

Our educational software is used in thousands of schools and homes throughout Great Britain.

KON-TIKI by J Amos *BBC* *Tape £12.95 Disc £14.95*
 Simulation program based on Thor Heyerdahl's KON-TIKI expedition. Enjoy a journey on the Kon-Tiki recording on a map the raft's position and entering notes in the logbook on creatures found, unusual events etc. Inclusive of booklet, background information, maps and fully supportive illustrated data sheets.

EDUCATIONAL 1 *BBC/ELECTRON* *Tape £8.00 Disc £10.00*
 Hours of fun and learning for children aged five to nine years. Animated graphics will encourage children to enjoy counting, maths, spelling, and telling the time. The tape includes six programs: MATH1, MATH2, CUBECOUNT, SHAPES, SPELL and CLOCK.
 ... 'An excellent mixture of games' ... *Personal Software - Autumn 1983.*

EDUCATIONAL 2 *BBC/ELECTRON* *Tape £8.00 Disc £10.00*
 Although similar to Educational 1 this tape is more advanced and aimed at seven to 12 year olds. The tape includes MATH1, MATH2, AREA, MEMORY, CUBECOUNT and SPELL.

FUN WITH NUMBERS *BBC/ELECTRON* *Tape £8.00 Disc £10.00*
 These programs will teach and test basic counting, addition and subtraction to four to seven year olds. The tape includes COUNTING, ADDING and an arcade type game to exercise addition and subtraction. With sound and visual effects.

FUN WITH WORDS *BBC/ELECTRON* *Tape £8.00 Disc £10.00*
 Start your fun with alphabet puzzle, continue your play with VOWELS, learn the difference between THERE and THEIR, have games with SUFFIXES and reward yourself with a game of HANGMAN.
 ... 'Very good indeed' ... *A&B Computing - Jan/Eeb 1984.*

JIGSAW AND SLIDING PUZZLES *BBC/ELECTRON* *Tape £7.95 Disc £9.95*
 There are two jigsaw and four sliding puzzles on a 3 x 3 and 4 x 4 grid. Each program starts off at an easy level to ensure initial success but gradually becomes harder. It helps children to develop spatial imagination and in solving problems. The tape includes: OBLONG, JIGSAW, HOUSE, NUMBERS, CLOWN and LETTERS!

GAMES & UTILITIES

GAMES OF LOGIC *BBC* *Tape £4.95 Disc £6.95*
 For children and adults alike. The tape includes AUCTION, FLIP, REVERSE, TELEPATHY and HEXA 15.
 ... 'This package is good value' ... *Acorn User - Nov 1983.*

SUPERLIFE *BBC/ELECTRON* *Tape £4.95 Disc £6.95*
 Fast (machine code) version of a popular 'GAME OF LIFE' in a large universe.

KATAKOMBS *BBC* *Tape £5.95 Disc £7.95*
 The ultimate adventure game.

UTILITIES *BBC/ELECTRON* *Tape £5.95 Disc £7.95*
 An assortment of useful procedures and functions which can save you hours/days of programming effort: date conversion, input and validation routine, graphic routines, sort, search and many more.

★★ SPECIAL OFFER ★★

Buy three titles and deduct £4.00

Add 50p p&p per order. Please state BBC or Electron. Cheque/PO

Golem Ltd, Dept A, 77 Qualitas, Bracknell, Berks RG12 4QG. Tel: 0344 50720.

**confused
 frustrated
 fed up !!
 your computer
 recorder has failed
 yet again . . .
 . . . then try our
 dedicated cassette
 recorder.
 and its BRITISH**

**data recorder
 model
 281**



Please send me further information

name

address

..... tel no.

Coomber

COOMBER ELECTRONIC EQUIPMENT LIMITED
 CROFT WALK (Nr Pitchcroft) WORCESTER WR1 3NZ
 TELEPHONE WORCESTER (0905) 25168/9 TELE X 339490

STOCK ANSWERS

'Purchasing' and 'Stock Control', Acornsoft, BBC B, £24.95 each

THESE two programs, part of a suite of seven programs produced by Acornsoft, are an excellent idea well put together, and if there are minor irritations in using them that should not detract from the merits of the plan.

The business manager considering solving all his paperwork problems for the hardware cost along with seven programs for under £175 would do well to see a full demonstration before settling on this system. Not that it doesn't work, but the investment is likely to be greater and the learning experience more painful. If our manager is already knowledgeable about the BBC micro then there is no great problem, but if not, read on...

The guides are identical except for the section that deals with the specialist function of the program concerned (see Barry Pickles' review of *Invoicing* and *Mailing List*), and they are written well and clearly in simple terms, presented in a folder which is very attractive, and convincing in its professional approach. I could have wished that the folder and the disc had made clear that a 40-track system was in use.

With the *Purchasing* and *Stock Control* programs working it was at last possible to see what they could do, and it was quite impressive. They had a common basic content which is described by the menu and appears as follows:

SYSTEM SETUP MENU

- 1 Name and Address
- 2 System Details
- 3 Modules in Use
- 4 Update Parms (parameters) File
- 5 Create Data Files
- 6 Extend Data Files
- 7 Exit

These need little explanation, for the menu-driven arrangement is remarkably easy to follow and produces the expected results as the options offered speak for themselves. The instruction to exit is rather important, as otherwise valuable data files may be corrupted. This menu is common to all programs in the suite and a model for such links, although some simple use of graphics could have been made to encourage the workers.

Taking first the *Stock Control* set of programs, there is again a menu which makes a convenient starting point for the

description, and which appears as follows:

STOCK CONTROL MENU

- 1 Product Update
- 2 Stock Movements
- 3 Stock Level Report
- 4 Stock Analysis
- 5 Exit

For the first four options the immediate response is to request the data disc, which can then be updated with additional information – which in turn becomes available for all the other programs. Again, these options speak for themselves but I am satisfied they cover all the likely combinations of circumstances that most businesses will face. The list of products is almost unlimited in theory, and there is scope for predicting forward patterns and fixing warning levels for stock needs. So the range of stock can be easily changed and movements monitored with ever-ready reports of stock level, reconciliation for stock-taking purposes, and the associated valuation, with easy instructions to print out the reports in convenient forms on almost any printer.

The ways in which the *Purchasing* program links with *Stock Control* are obvious and they work as expected, so again it seems best to start with the menu:

PURCHASING MENU

- 1 Supplier Update
- 2 Item Update
- 3 Purchase Order Update
- 4 Order Progress
- 5 Order Analysis
- 6 Invoice Validation
- 7 Exit

These options are obvious to anyone likely to have a use for the program and, as the manual says, the purpose of the *Purchasing* module is to enable you to maintain supplier and item records; enter and maintain purchase order details; and record deliveries and analysis commitments made. It does all these and could maintain immaculate records for the business: perhaps it could even save a little money at the same time.

All very straightforward, but I wonder to what extent these programs would help a small business, as the advertising suggests. If the manager is a BBC micro enthusiast who wants to mix business with pleasure and turn his hobby to profit, then I have no reservations: buy it, it works! If on the other hand he is already very busy

Roger Carus reports on Acornsoft's 'Purchasing' and 'Stock Control' packages

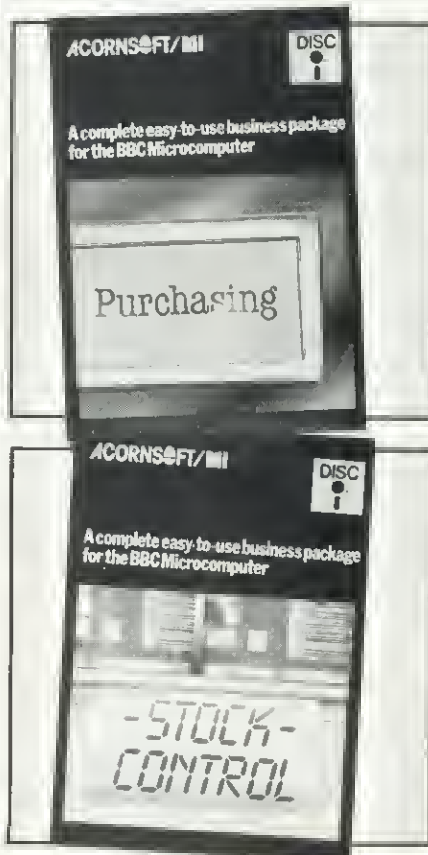

with customers and will have to delegate the keeping of records to staff with limited ability or interest, then there will be serious problems and these will hardly be solved by employing expensive staff: for a small business this would be uneconomic, and for a large one the BBC micro would be the wrong hardware. I suspect that to be cost effective the programs would have to be used with a relatively small number of products and suppliers, which in turn suggests high-cost items and a small turnover in terms of transactions.

There is, however, a use for these programs that is not mentioned in the advertising or in the manuals and that is in the training of students on business courses. Those concerned with the courses of the Business and Technician Education Council would find these programs invaluable for training students following the General, National and even Higher Certificate in Business Studies and it would be relatively simple to set up complex business simulation exercises using one group of students to input the data and a second to manipulate it in various ways. Acorn should give more thought to the true nature of its market.

4

Emmanuel St.

Our *new* Personal Computer Centre specializing in the BBC Micro with complete support

we know computers

1 Business & Professional
Tel 0223 65335 4



Home & Educational **4**
Tel 0223 358264

Cambridge Computer Store

1 & 4 Emmanuel Street, Cambridge

WHAT A SAUCE!

Universities and Collages have been buying

WHAT'S TO EAT?

The Practical Home Menu Planner which is fun and easy to use for their catering students and finding it useful. But they really need the mouth-watering and purpose designed

MENU MASTER Suite

Recipes and ingredient quantities from "Practical Cookery"; scaling to 96 cmts; printing menus, prices, kitchen and order lists; creating/amending recipes, etc. . . .

WHAT'S TO EAT

Home Pack

Cassette £10.45 40T disc £13.45

Teaching Pack 40T disc £17.95

Prices inclusive of VAT and post/packing (Overseas Disc £14; Cassette £11, excludes VAT, includes airmail)

MENU MASTER College Pack

Send A4 SAE for details

† By Caserani & Kinton (fifth edition) published by Edward Arnold

SHUMWARI ASSOCIATES

(Dept. B)

12 Marlin Court, Marlow SL7 2AJ

keep it all together with one of our tidy boxes



model 3034

Please send me further information

name

address

.....

..... tel no.

Coomber

COOMBER ELECTRONIC EQUIPMENT LIMITED
CROFT WALK (Nr Pitchcroft) · WORCESTER WR1 3NZ
TELEPHONE WORCESTER (0905) 25168/9 · TELEX 339490

DOT MATRIX PRINTERS

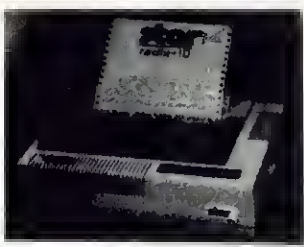

ALL PRINTERS HAVE CENTRONIC PARALLEL INTERFACE UNLESS OTHERWISE STATED. ALL PRINTERS HAVE HI-RES. DOT ADDRESSABLE GRAPHIC MODE. PLEASE SEND SAE FOR FULL DETAILS.

EPSON	
FX 80 160 CPS, 10" wide trinc, 8 pin lead	£344 + VAT £395
FX 100 160 CPS, 15" wide trinc, 8 pin lead	£431 + VAT £495
RX80 F T 100 CPS, 10" wide trinc, 8 pin lead	£361 + VAT £399
RX80 T 100 CPS, 10" wide trinc, 8 pin lead	£234 + VAT £269
LQ1500 200 CPS Letter quality printer	
8143 HS 23 Interface for FX and RX printers	£99 + VAT £33
8144 RS32 Interface with 2K buffer, non roll	£80 + VAT £59
Ribbon Cartridge for RX80 FX80 & MX80	£7 + VAT £7
Ribbon Cartridge for FX100 & MX100	£12 + VAT £13

STAR	
Genmil 10X 120 CPS, 10" wide trinc, 8 pin lead	£200 + VAT £229
Genmil 15X 120 CPS, 15" wide trinc, 8 pin lead	£195 + VAT £239
Delta 10 160 CPS, 10" wide trinc, 8 pin lead	£327 + VAT £375
Delta 15 160 CPS, 15" wide trinc, 8 pin lead	£414 + VAT £475
Radix 10 200 CPS N10 16K Briter Par & serial interface, downloadable characters, incredible value at	
Radix 15 15" wide version of Radix-10	£431 + VAT £495
	£518 + VAT £595

SEIKDSHA	
GP100A 50 CPS, 10" wide tractor lead	£156 + VAT £179
GP200X 50 CPS, 10" wide tractor lead ser & par	£196 + VAT £225
GP100XC 30 CPS, 10" wide VIC 20 & 64 mini	£124 + VAT £139
GP500A 50 CPS, 10" wide tractor lead	£187 + VAT £215
GP550A 50 CPS, 11" wide tractor & tractor correspondence quality	
GP100AS Serial interface ideal for Spectrav with microdrive	£234 + VAT £269
	£174 + VAT £199

SHINWA	
CP80 80 CPS, 10" wide tractor & tractor lead	£187 + VAT £215
Spare ribbon cartridge for CP80	£6 + VAT £6

RITEMAN	
Compact 120 CPS, 80 col trinc & tractor lead	£200 + VAT £229

CANON	
FW1000A 160 CPS, 10" wide 27 CPS NLO 24 x 16 matrix	£283 + VAT £325
FW1150A 160 CPS, 15" wide 27 CPS NLO 24 x 16 matrix	£347 + VAT £399

COLOUR PRINTERS	
Sanyo GP200 7 colour, 50 CPS printer	£347 + VAT £399
Canon P1100A 7 colour, 40 CPS inkjet printer	£391 + VAT £449
CPFA0 40 column, 4 colour battery operated	£119 + VAT £135

ALL OUR PRINTERS HAVE 1 YEAR WARRANTY

DAISYWHEEL PRINTERS



JUKI 6100	
20 CPS Bi-Directional Logic, swing up, 10-12-15 CPI, PS	
Springs 7K printer, best selling Daisywheel	£149 + VAT £395
Singer speed feeder unit	£217 + VAT £249
Tractor Unit	£46 + VAT £109
RS 232 Interface	£52 + VAT £59
Spare Daisywheel	£17 + VAT £19

BROTHER HR-15	
15 CPS Bi-directional 10 12 15 CPI, PS	£344 + VAT £395
Keyboard Unit	£139 + VAT £159
Simple Sheet Feeder Unit	£217 + VAT £249
Tractor Unit	£56 + VAT £109

DAISY STEP 2000	
20 CPS Unidirectional 10 12 15 CPI	£260 + VAT £299

SMITH CORONA TP1	
12 CPS, 10 12 CPI unidirectional	£208 + VAT £239

PROFESSIONAL MONITORS

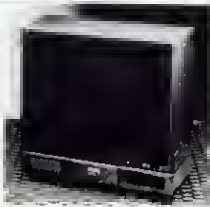

*** SANYO
* MICROVITEC
* FIDELITY
* PHOENIX**

SANYO	
DM8112 12" Green screen, 18 MHz Hi-Res	£86 + VAT £99
DM2112 12" Green screen, 15 MHz Monitor	£66 + VAT £75
CD1325 14" RGB Normal Res. Colour Monitor	£173 + VAT £199
CD3117 14" RGB Medium Res. Colour Monitor	£286 + VAT £329
CD3115 14" RGB High Res. Colour Monitor	£397 + VAT £449

MICROVITEC CLUB	
1431 MS 14" RGB Normal Res. Colour Monitor	£173 + VAT £199
1451 MS 14" RGB Medium Res. Colour Monitor	£287 + VAT £329
111 14" RGB High Res. Colour Monitor	£397 + VAT £449

FIDELITY Colour Monitor	
CM1414 RGB RGBY Composite sound col	£187 + VAT £215

PHOENIX	
Phoenix High Res 12" Green Monitor	£66 + VAT £75
Phoenix High Res 12" Amber Monitor	£69 + VAT £79

BBC MICROCOMPUTER SYSTEM

WE ARE AN OFFICIAL BBC COMPUTER DISTRIBUTOR
DEALER ENQUIRIES ARE WELCOMED

Acorn Electron £199^{INC} VAT

WE SUPPLY FREE 30 HOUR BASIC BOOK AND A DUST COVER WITH EACH BBC COMPUTER

BBC is the best micro or input currently on the market, 32K RAM, 32K ROM, 8 modes of operation, full size keyboard, internal expansion slots such as disc, interface, speech synthesizer. Economical interface in slot it is a personal computer capable of expanding into a small business system.

BBC Mod B - Econet interface	£148 + VAT	£399
BBC Mod B - Econet interface	£408 + VAT	£469
BBC Mod B - Econet interface	£369 + VAT	£427
BBC Mod B - Econet interface	£450 + VAT	£517
BBC 100K disc drive	£270 + VAT	£264
BBC 500K disc drive	£399 + VAT	£403
Torch Z80 disk pack including Z80 2nd processor, 64K RAM and CP/M operating system - Para Petrol Software	£696 + VAT	£799
BBC Triflex keyboard - Angl	£196 + VAT	£225
BBC cassette recorder and lead	£25 + VAT	£29
Disk interface kit (disc fitting)	£34 + VAT	£36
Mod A to Mod B upgrade kit	£70 + VAT	£80
Fading charge for A to B upgrade kit	£20 + VAT	£23
16K memory upgrade kit	£30 + VAT	£34
Games paddles	£11 + VAT	£12
12" Triflex monitor - 600 lines	£89 + VAT	£102
14" Colour monitor incl cable	£199 + VAT	£222
User guide	£10 + VAT	£10
Econet interface - disc fitting	£90 + VAT	£99
Speech interface (disc fitting)	£37 + VAT	£34
BBC disk manual, format disk	£10 + VAT	£11
Parallel printer cable	£22 + VAT	£25
BBC Mod processor (new)	£15 + VAT	£17
BBC 500K language cassette	£15 + VAT	£17
BBC 100K language cassette	£15 + VAT	£17

APPROVED ECONET SERVICE CENTRE

WE STOCK A LARGE RANGE OF SOFTWARE FOR BBC MICRO INCLUDING ACORN'S BEST BBC SOFTWARE LONGHAND SOFTWARE. PLEASE SEND LARGE STAMPED ADDRESSED ENVELOPE FOR FULL DETAILS.

TORCH Z80 2nd PROCESSOR

For only £347 + VAT

Torch 2nd Processor Z80 is supplied with perfect writer in powerful Word Processor, perfect printer in perfect program. In addition there used one for making this even if Perfect Filer (A Database Program), Perfect Calc (Spreadsheet), 111 in 100s 64K memory 1 Almost 60K available to use in Fits inside BBC Computer.

Z80 2nd Processor - Perfect Software	£347 + VAT	£399
Z80 Processor - Perfect Software - Dual 800K Disk Drives	£695 + VAT	£799

GUARANTEED LOWEST PRICES

100% BBC COMPATIBLE MITSUBISHI AND TEAC SLIMLINE DISK DRIVES



These drives are supplied ready cased with all the necessary cables, formatting program and User Guide.

There are some very useful utilities included on formatting disc e.g.

- * DISASSEMBLER. This is a 602 machine code disassembler.
- * DUP. To copy and rename a file on disc.
- * FDMIT. Formatting program for 40 & 80 tracks.
- * FREE. This utility provides a disk usage analysis.
- * MDDUMP. Enables you to display and modify any part of BBC memory.
- * RELOCATE. Merge a number of text files into one file.
- * RELOCATE. Downloads a basic program to EEPROM.
- * SDUMP. Screen dump for EPSON in all graphic modes.
- * VERIFY. Verifies every sector on a disk.
- * MENU. A flexible menu program.

Single drive 100K 40 trks, single sided	£147 + VAT	£169
Single drive 200K 40 trks, single sided	£296 + VAT	£329
Single drive 200K 40 trks, double sided	£173 + VAT	£199
Single drive 400K 80 trks, double sided	£330 + VAT	£379
Single drive 400K 80 trks, double sided, DS	£199 + VAT	£229
Dual drive 800K 80 trks, double sided	£217 + VAT	£249
Dual drive 800K 40 trks, double sided	£382 + VAT	£439
Dual drive 800K 40 trks, switchable DS	£438 + VAT	£469

All above drives are low power slimline (0.3 A typ at 12v and 0.4 A at 5v per drive). Normally extra power supply is not required the BBC Computer power supply is designed to drive two low power drive. IT IS NOT DESIGNED TO DRIVE INTERNAL ROM BOARD.

40 Track SS-DD diskettes (10 Box) £18 + VAT £20

40 Track DS-DD diskettes (10 Box) £23 + VAT £26

80 Track SS-DD diskettes (10 Box) £28 + VAT £32

80 Track DS-DD diskettes (10 Box) £30 + VAT £34

ALL ABOVE DISKETT ARE CERTIFIED EITHER MEMOREX OR DETALIFE

YOUR CONTACTS AT AKHTER ARE

DEALER-BULK ENQUIRIES	HAMAYUN MUGHAL
TELEPHONE ORDERS	PAULA HAYES
DEALER ORDERS	TONY GLOVER
BUSINESS SYSTEMS ENQUIRES	DENNIS BUTCH
EXPORT ENQUIRES	MAHAMAD ED/IB
ECONET SYSTEM TECHNICAL ENQUIRES	ALAN LAFFOLEY
ACCOUNTS	CARON ANDREWS
DESPATCH	PAUL SWIFT
REPAIRS	JOHN MAULE

Prices Correct at the time of this advertisement going to press.

BUSINESS SYSTEMS



APRICOT — SIRIUS — SANYO IBM — TEXAS — TEAC

APRICOT 'Portable Executive Computer' 16 Bit Micro, 256K RAM up to 1.44 megabytes floppy disk storage, 3 1/2" Sony disks. Portable brief case styling. Modern with auto dialler (optional) hard disk optional. Vast software library (compatible with Sirius II). Apricot with Single Drive and Monitor and Apricot with Double Drive and Monitor and Free Printer or 2nd Monitor. £1890 + VAT

SANYO PROFESSIONAL COMPUTER 16 Bit Micro, 128K RAM expandable to 256K. Single or Double Disk Drive built in all about graphics (80x200 or 80x256 or 80x300) IBM compatible Free software: Sanyo MBC 550 128K RAM single drive and free software including Wordstat and Calcstat. £1399 + VAT

SIRIUS II Sirius I Computer with 128K RAM and 1.2 megabyte floppy disc storage including CP/M 86 MS DOS and Microsoft Basic. £2195 + VAT

Sirius I Computer with 256K RAM and 2.4 megabyte floppy disc storage including C.C.M. 86 MS DOS & Microsoft Basic. £2895 + VAT

TORCH **CF500 COMPUTER** with colour monitor includes Twin 400K disks. Torchnet operating system free. Perfect software, perfect writer, perfect printer, perfect calculator, perfect files. Torchnet Plus, Electronic Mail, Torch Mail, Financial modelling with graphics, Torchnet (Viewdata Access System) Executive Aid (Menu System). Data Link to outside main frame services like Telecom Gold. £2995 + VAT

TEXAS INSTRUMENTS PROFESSIONAL COMPUTER TI3200 Dual 320K Drives 256K RAM. Up to 10 megabyte on board storage possible. TI speech command hardware option brings a new level of user friendliness to computing. Allows voice operated keyboard control. (Optional). Price £2550 + VAT

MAINTENANCE CONTRACTS ARE AVAILABLE

COMPLETE WORDPROCESSING SYSTEMS INCLUDING DAISYWHEEL PRINTER

From £695 + VAT

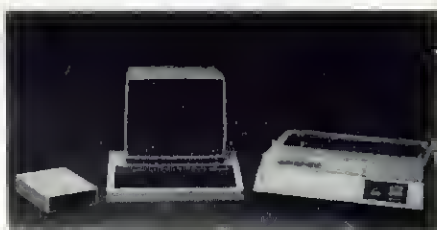

SYSTEM 1 BBC Micro model B, Wordwise, Phoenix monitor, Smith Corona TP1 Daisywheel Printer, Casset Recorder, all the necessary cables and documentation. Price only £595 + VAT £799.25

SYSTEM 2 BBC Micro model B + Disk Interface, Phoenix Monitor 100K Single Disk Drive, Wordwise, Smith Corona Daisywheel Printer, all the necessary cables and documentation. Price only £895 + VAT £1029.25

SYSTEM 3 BBC Micro model B + Disk Interface, Phoenix Monitor, Dual Disk Drives 200K Wordwise, Smith Corona Daisywheel Printer, all the necessary cables and documentation. Price £999 + VAT £1148.85

SYSTEM 4 BBC Micro model B + Disk Interface, Sanyo High Res Green Monitor, Wordwise for view, Juki 6100 Daisywheel Printer, Single 400K Disk Drive, all the necessary cables and documentation. £1049 + VAT £1206.35

SYSTEM 5 BBC Mod B Micro + Disk Interface, Sanyo High Res Green Monitor, Wordwise for view, Juki 6100 Daisywheel Printer, Dual Disk Drive 800K + all the necessary cables and documentation. Price £1195 + VAT £1374.25

SYSTEM 6 Sanyo 16 Bit IBM compatible Micro 128K RAM, Single Disk Drive, Phoenix Monitor, Calc Stat, Sanyo High Res Green Monitor, Juki 6100 Daisywheel Printer - all the necessary cables and documentation. Price Only £1145 + VAT £1316.75

SYSTEM 7 Sanyo 16 Bit IBM compatible Micro 128K RAM, Dual Disk Drives, Phoenix Monitor, Calc Stat, Mailmerge, Infolink, Spellstar, Database Sanyo High Res Green Monitor, Juki 6100 Daisywheel Printer, and all necessary cables and documentation. Price £1395 + VAT £1604.25

SYSTEM 8 All the components of System 7 but with Sanyo High Res Colour Monitor and Wordstar with Colour Facilities. Price £1445 + VAT £1661.75

SYSTEM 9 All the components of System 7 but with Sanyo High Res Colour Monitor and Wordstar with Colour Facilities. Price £1695 + VAT £1849.25

WE CAN ALSO SUPPLY PACKAGES WITH COMPONENTS OF YOUR OWN CHOICE. PLEASE PHONE (0279) 443521 AND ASK FOR HAMAYUN MUGHAL FOR A PRICE



AKHTER COMPUTER GROUP

28/29 BURNT MILL
HARLOW, ESSEX, CM20 2HU U.K.
Tel. HARLOW (0279) 443521 Telex 818894 AKHTER G

ORDERING INFORMATION:

We accept official orders from UK Government and Education establishments. Carriage is Free (UK only) for normal delivery. If express delivery is required please add £8.00 + VAT per parcel. We accept telephonic orders on Barclay and Access Card please ring (0279) 443521 (10 lines). All cheques made payable to AKHTER INSTRUMENTS.

N.B. ALL VAT INCLUDED PRICES ARE THE CORRECT PRICES. EXCL. VAT PRICES HAVE BEEN ROUNDED UP TO NEAREST POUND

OPENING HOURS: MON-FRI 9am-6.30pm, SAT 10am-5pm
We welcome callers, no parking problems.



READ/WRITE PROGRAM

Introducing the micro to adult literacy classes, by Jonathan Read

MORE THAN two million adults in Britain are estimated to have difficulty reading or writing. This is not a new problem and evening classes in Basic Literacy have been going for many years, and the Adult Literacy Resource Agency was set up in 1975. In the same year the BBC started a three-year adult literacy project, which included a series of programmes called *On The Move* that encouraged people who wanted to be better at reading or writing to come forward.

Several years later, people of all ages are still coming to evening classes in Adult Literacy or are being taught at home. The students know they have tried very hard in the past and not succeeded, and so the tutor needs to find work for the students that they can successfully carry out to prove to themselves they really can learn. They need plenty of reading and writing practice but the books available tend to be too difficult or too trivial, and students don't like to do writing because they think that makes them look stupid.

These factors prevent the students from becoming really involved in their work and they waste a lot of time trying to hide their ignorance from their tutor, and from themselves. Some students can put up a better front than others, but they all try to get the tutor to give them work that they already know so that they are bound to get it right. This is no help to the students.

The tutor has to find activities connected with reading and writing that the students have not done before but which they are prepared to try. Tutors use activities such as educational games or work-sheets for this purpose, and computers can be used as well. I am not saying a computer is bound to work better than other methods; its success will depend on how much the students like using it, and how well it fits in with their other work.

The computer should complement the tutor's qualities. It has more patience and more flexibility. The students do not seem to be afraid of using the computer, which may be partly due to its novelty, but if it

does not enable real learning, students quickly lose interest.

To benefit fully from the patience of the computer, students need to work at their own pace without being made to carry on if they are not ready. It helps neither students nor tutor if the students are left in front of the computer, for the tutor loses the chance to learn from the students' mistakes and if the students get stuck the computer is too inflexible to do anything about it.

I have summarised the type of program that suits this approach best in a check-list (see panel), each point of which I will discuss in turn.

Surprisingly, point 1 is not always met – for example, programs often tell the student how long he has taken, or they ask a fixed number of questions. The student cannot therefore stop in the middle of the program without feeling he has failed to achieve what is required.

Point 2 is easy to violate accidentally. For example, a program that asks a question and says 'Well done!' when given the expected answer, or 'Are you sure?' when the student answers incorrectly and lets him have another go would not be satisfactory, because the students would soon learn to change their answer next time round and appear to know more than they actually do.

Programs written by teachers should not suffer from this fault.

Point 3 would not be satisfied by a

program that asks a series of questions, at the end of which it says how many the students got right without saying which questions were answered correctly.

Point 4 needs stating because of the inflexibility of the computer, and should avoid the students being put off using it simply because they hit a wrong key.

Point 5 is probably the most controversial. Since the students have come to the lesson of their own accord they must want to learn and so they do not need marks to motivate them. The tutor should be present and so he gets a much better idea of how the student is doing than he could get from a mark given by the computer. Also, because the program is supposed to be teaching as opposed to testing the students it is not fair to count their mistakes.

The listing (page 113) is a program that I think satisfies the check-list.

The program flashes a word on the screen and the student has to read it. It was originally intended to help students who confuse words that look very similar, but it could also be used for revision before a spelling test, or if some of the words were spelt incorrectly the students could be asked to recognise which ones were right.

In use, the tutor presses the space bar down and the screen goes blank. It stays blank for as long as the tutor keeps the space bar down and so if the students need to pause to collect their thoughts the

page 117 ▶

CHECK-LIST FOR ADULT LITERACY PROGRAMS

1. The computer works at the pace of the student, and it is always possible to stop when the student wants to.
2. The student cannot get everything right by using an incorrect idea of his own, so he needs to learn and understand what is being taught.
3. Feedback should be given as soon as possible, but not so quickly that it interrupts the students' train of thought.
4. The student should be allowed to change his answer before the computer checks it, unless the program is teaching speed or accuracy.
5. The computer does not maintain any record of the student's marks.

All disc software now available on 3" disc - add £3.00 to printed prices.

BBC MICRO COMES OF AGE..

β-BASE:

£25.00

β-BASE is a very powerful and very flexible database program. Because β-BASE is designed specifically for disks there are none of the limitations found in most database programs, which are usually upgraded cassette programs. β-BASE is not limited by memory and even the disk limit can be overcome easily to provide an unlimited file size. Take a look at the features listed below and compare it with so called professional programs at up to £400, we think that you will be amazed. Why limit yourself to a 16K eprom - β-base contains approx. 30K of tightly compacted code.

Maximum File Size (40 track) - 99k & (80 track) - 199k.
Maximum Record Size - 2k; Maximum Number of Fields - 200;
Maximum Field Length - 254 chrs.

Options Include:

- 1) WRITE - for adding records.
- 2) WDRK - for displaying records, editing and deleting.
- 3) CALC - allows you to cope easily with fluctuating prices and VAT rates. (works with whole file or search lists). Uses EVAL function allowing complex calculations to be performed, and the results to be displayed on screen or placed in a nominated field.
- 4) SEARCH - multiple function search on up to 5 fields.
- 5) OPTIONS: a) sort records found in search on 3 fields in ascending/descending order (max records sorted is 500).
b) work search list, with edit and delete.
c) save records found in search to disc.
d) load previously saved search list.
e) make a search list.
- 6) PRINTER - copes with parallel and serial printers and allows you to set up the printout + all printer codes allowed + allows you to join fields together and allows you to set them into columns etc. A label print routine allows single or double labels to be printed.
- 7) REDEFINE - allows you to transfer all records from old file to new file plus add or amend field or record size. No more re-entering all your data if you wish to add a field.
- 8) TRANSFER - allows you to transfer selected records between files.
- 9) NEW - allows you to define new file.
+ real time clock + many more features.

If you want a professional database for the BBC micro the β-BASE is your only option.

Not compatible with Amcom DFS.

REPLICA II:

£12.00

This is the one that everybody has been waiting for. The original REPLICA set a very high standard and many said that it could not be improved. The specification that we set our chief programmer included some supposedly 'impossible' features. In fact ACDRN state that some of the things that we have done are impossible, it just took us a little longer that's all. REPLICA II will transfer most of your cassette based programs to disk, even more than REPLICA did. Now when you buy disk drives you do not have to throw away your expensive cassette based programs. REPLICA II will transfer 'LOCKED' programs, programs loading as files, programs that load below 8000, those with up to 6 sections and those up to 66 in length eg adventure programs. No more waiting for 6 minutes whilst your adventure programs load. REPLICA II is very easy to use and the user just enters a name, how many sections and whether CHAIN, *RUN or *LOAD is used to load the first section. Press play and let the program do the rest, even a menu. You cannot afford not to have a REPLICA II, think how much it will cost you to buy just 1 disk version of your favourite program - it is probably more than REPLICA II which will hold up to 16 programs, limited only by the disk capacity.

BEEBSYNTH: disk £11.00 cassette £8.00

A very powerful yet easy to use sound generating program that can be used by expert and novice alike. Up to 16 envelopes can be defined and saved. The envelope definer is very easy to use, control is through the cursor keys, and the effects of your changes can be heard immediately. When you have defined your envelopes press 'K' for Keyboard and the keyboard is transformed into a musical instrument, but you control which instrument. Lets you play chords, not just single notes, change pitch and duration etc etc. A superb program that you can use immediately. Unlimited sounds at your disposal. Recommended by MICRD USER, PCN, HCW etc.

THE KEY:

£12.95

A disk utility program that provides the user with the tools to explore the disk environment and use it to its best advantage. The programs are:

- 1) FORM40 - Formats and verifies 40 track disks.
- 2) FORM80 - Formats and verifies 80 track disks.
- 3) BACKUP - Allows backup copies of your valuable disks to be made.
- 4) EDITOR - Enables the user to read the disk sector by sector and to alter programs on the disk, even most protected and unlistable ones. More fun than any adventure game.
- 5) RETRIEVE - Allows the user to recover data or programs that have been accidentally erased or damaged by a head crash.

Every disk owner should have one, you will wonder how you ever managed without it. Recommended by WHICH MICRD, EDUCATIONAL COMPUTING etc. THE KEY has been imitated by many but bettered by none.



JOYSTICK UTILITY:

£6.00

Converts non joystick programs to work with joysticks. Works with any program using INKEY (-) in Basic or machine code, to detect movement, which applies to most programs. The routine is relocatable and sensitivity of the joystick can be varied. Compatible with most games, including Acornsoft. Very easy to use, just press the keys you want to transfer. The machine code can be saved as a block of just 100 bytes. Supplied on cassette but can be transferred to disk.



SHADOW:

£8.00

SHADOW is a tape cloning program that will enable you to make security copies of your own valuable cassette software. SHADOW works with 99% of all known programs including those with sections at 300 BAUD and those that load as files. SHADOW will handle programs with any number of sections and it will work with any of the current operating systems including D.1, 1.0, & 1.2. SHADOW is the definitive tape backup system and as a bonus you also get 'INSPECTOR' on the same tape. This allows you to view all areas of memory, search and alter bytes, etc. Colour coding helps to simplify memory usage. All this for just £8.00. I don't know how we do it. 'It is a condition of sale that this program is not used for piracy'.

State 40 or 80 track when ordering discs.

NOTE: All prices are inclusive of VAT and postage - ND EXTRAS!

Clares
MICRO SUPPLIES

**Dept. AU6, 98 Middlewich Road,
Northwich, Cheshire, CW9 7DS.**
Tel: 0606 48511 Open 9.5pm. Monday-Friday
All prices inclusive of VAT + Carriage - No Extras.

```

10 REM (C) J. M. Read
20
30
40 REM ----- S E T U P   C O N S T A N T S -----
50
60 MODE7: !&FE00=&10200A :REM Cursor Off
70 DHEIGHT$=CHR$ 141
80 Error=FALSE
90 OutOfData=42
100 Space= "99
110
120 Line=12:Col=15 :REM Sets position of words on screen.
130
140
150 REM ----- C O U N T   W O R D S -----
160
170 ON ERROR GOTO 250
180 NoOfWords=0
190
200 REPEAT
210 READ W$
220 NoOfWords=NoOfWords+1
230 UNTIL Error
240
250 IF ERR=OutOfData GOTO 340
260
270 PRINTTAB(0,20):REPORT:PRINT " at line ";ERR
280 !&FE00=&10720A :REM Cursor On
290 END
300
310
320 REM ----- M A I N   L O O P -----
330
340 Lwordno=0:Lwordno2=0
350
360 W$=FN_NextWord
370 REPEAT UNTIL NOT INKEY(Space) :REM Wait for Space Bar to be Released.
380 PRINTTAB(Col,Line) DHEIGHT$ W$
390 PRINTTAB(Col,Line+1) DHEIGHT$ W$
400 REPEAT UNTIL INKEY(Space) :REM Wait for Space Bar to be Pressed.
410 CLS
420 GOTO 360
430
440
450 REM ----- C H O O S E   N E X T   W O R D -----
460
470 DEF FN_NextWord
480 wordno=RND(NoOfWords)
490 IF wordno=Lwordno AND Lwordno=Lwordno2 THEN
REPEAT wordno=RND(NoOfWords):UNTIL wordno()Lwordno
500 Lwordno2=Lwordno:Lwordno=wordno
510 RESTORE: FOR i=1 TO wordno:READ W$:NEXT i
520=W$
530
540
550 REM ----- W O R D S   U S E D -----
560
1000 DATA There
1010 DATA Their
1020 DATA Then
1030 DATA Them
1040 DATA They

```

Electronequip

(Authorised BBC Dealer, and service centre)

NEW EXTENDED TEL. ORDER SERVICE

6 Sales lines manned to 10pm
Monday to Friday

*** SPECIAL OFFER**

EPSON*

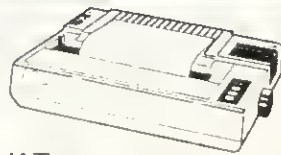

RX-80 F/T £245.52 + VAT

FX-80 £365.09 + VAT

Printer price includes cable for BBC and screen
dump rom.

Voltmace Delta 14B

10% off
*** listed prices**



JSVOLT14 Voltmace Delta 14B Joysticks.....13.00 14.85
JSVOLTAD Voltmace 14B/1 Adaptor Box.....12.91 14.85

TRADE ENQUIRIES WELCOME

Access & Barclaycard Accepted
Large Stocks - 24 Hour Despatch
Carriage 50p



**ACORN
COMPUTER**

Electronequip

36-38 West Street, Fareham, Hants (0329) 230670

2 FREE ACORNSOFT GAMES WITH EVERY BBC SOLD*

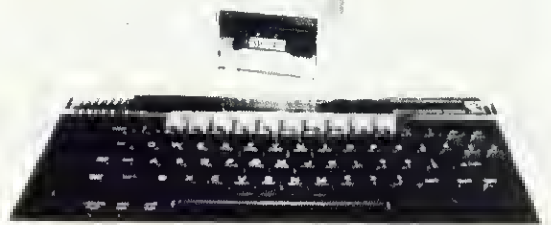

Electronequip is an authorised Acorn service centre and has
been an Acorn dealer since the introduction of the Atom.
Our demonstration facilities include 20 station Econet and
Torchnet systems.

Ref.	BBC Micros	Ex VAT	Inc VAT
ANB01	BBC Model B Micro Computer	348.26	399.00
ANB02	BBC Model B with Econet Interface	389.14	446.00
ANB03	BBC Model B with Disc Interface	426.59	489.00
ANB04	BBC Model B with Disc & Econet Interface	467.45	536.00

3" Micro Disc £129.95
(inc. VAT)

Disc Interface & Drive
£198.95 (inc. VAT)

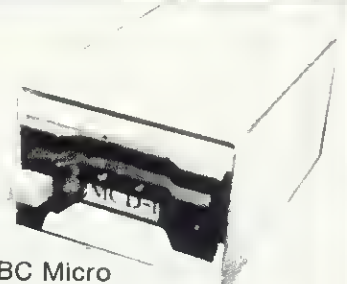

Micro Disc Drive for the BBC Micro

The Micro disc drive offers a method of low cost quick access to
programs. The drive is essentially a small version of a 5 1/4" disc
drive and offers similar features to the larger drive.
The data is stored on a 3" disc, this is enclosed in a protective
hard plastic cassette which features a write protect switch.
The micro drive requires the standard Acorn disc interface, but a
new disc filing system rom. Acorn DFS may be exchanged for the
micro DFS for £12.00. The new micro disc filing system allows 60
files per disc surface and it can read and write to Acorn DFS discs.
Thus if a 5 1/4 inch and a micro floppy were connected on the same
cable files could be transferred between them.

Capacity: 80.64 K bytes **Transfer Rate:** 125kbit/s

BRANCHES

FAREHAM 59 WEST STREET
(0329) 230670
KINGS LYNN 17 TENNYSON AVENUE
(0553) 3782
MAIL ORDER 36-38 WEST STREET, FAREHAM
HANTS
(0329) 230670

BBC

MATHS FROM MANY ANGLES

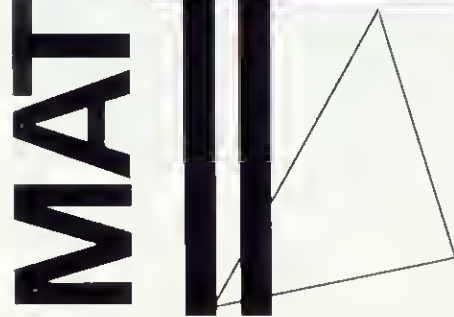

Martin Wallis examines a mixed suite of programs for use in classroom question-and-answer sessions or discovery exercises

115

THE Association of Teachers in Mathematics has collected together a package of 11 programs for the BBC model B under the title *Some Lessons in Mathematics with a Microcomputer*. The programs are written by different teachers who have used them extensively in the classroom. As a result they are all well-tested and easy to use, either with the whole class or as an activity for a smaller group of pupils.

For each program, the colour-coded 100-page booklet supplied contains a brief description showing how to start using it, a reference guide and some suggestions about planning lessons using the program as an aid. But as the introduction says, 'There are very few firm rules about the way it (the microcomputer) should be used in a lesson', and the computer cannot be switched on at the beginning of a lesson, leaving the teacher, feet on desk, watching the class mesmerised by the screen. There are a variety of ways to use the programs to pose open-ended questions and to provide the opportunity for pupils to discover the answers for themselves.

To illustrate, *Build* allows the user to create three-dimensional structures in perspective using cubes on the screen, by keying in directions Up, Down, Left, Right, In and Out.

Build could be used to help pupils develop concise language to describe 3D structures. The class is divided into pairs

with a small cardboard barrier between them. The pupils take turns to build a model with small plastic interlocking cubes and describe it to their opposite number across the barrier, who tries to reproduce it using only these verbal instructions. First attempts to describe the diagram of figure 1, such as 'a bridge four cubes wide and two tall, with an extra cube in front of the bottom of both legs',

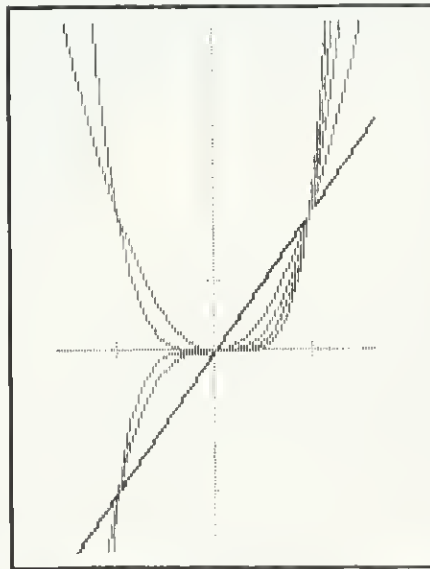

Figure 2. Dump from the function graph plotter program

can be improved as they move on to use the computer to draw their structures and discover how the code I U R R R D O is easier to use and less open to misinterpretation.

Further developments could include drawing rotations and reflections, investigating different ways of producing the same shape and discovering the effects of inverse instructions.

What this program has in common with the others is that it is best used in a situation where pupils discuss their ideas

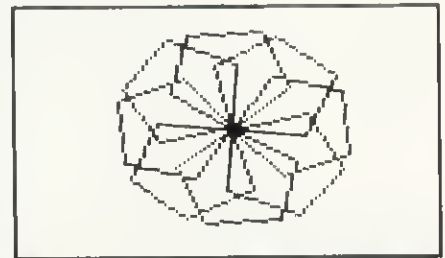

Figure 3. Recursive pattern produced in 'Track', a Logo-based picture-drawing language.

with each other and with their teacher, who can provide help on what to investigate and encourage pupils to predict what will appear on the screen.

Two of the programs draw loci that would otherwise be difficult to produce. *Circles* gives the locus of a moving circle which passes through a fixed point and touches a fixed circle, and *Arms* displays two rotating arms and plots the path of a point on an imaginary piece of elastic stretched between their ends. In each case, groups of pupils can predict the effect of varying the position and size of the arms or the fixed point and circle and quickly discover how accurate they were.

Two number games are included. In *Subgame*, five digits are displayed one after another and the user has to fit them into the pattern of a subtraction:

$$\begin{array}{r} a \ b \ c \\ - \ d \ e \\ \hline \end{array}$$

The computer does the same and you have to get an answer larger than the computer's. I would like to see an extension that allows larger numbers to be used, with the possibility of negative

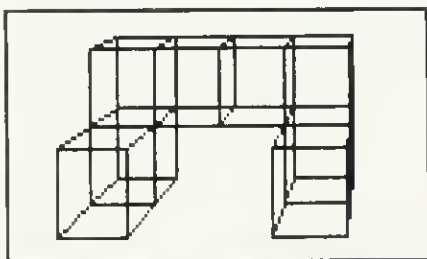

Figure 1. Three-dimensional structures are possible with 'Build'.

THE PACKAGE

Disc and book cost £15 (including VAT and p&p) from ATM, Kings Chambers, Queen Street, Derby DE1 3DA. The book on its own costs £3, inclusive.

HARRIS McCUTCHEON SYSTEMS

are pleased to release

HMS HOME ACCOUNTS.....	£28.75
HMS VAT TRADER'S LEDGER.....	£21.50
HMS BASIC ENVIRONMENT.....	£14.50

to BBC Microcomputer users with a minimum configuration of 1 x 40 track single sided disc and an 8" 132-column (condensed mode) printer, to a maximum configuration of 2 x 80 track double sided disc and a 15" printer. The programs allow user allocation of each file between 'DRIVE0, 1, 2 or 3, thus making full use of the disc space available.

HMS HOME ACCOUNTS allows all financial transactions within a defined environment to be recorded, printed and analysed. Accounts may be reconciled with statements or passbooks, unleared entries being highlighted. Depending on the analysis structure you choose, the system can keep track of anything from answering "how much is in the piggy bank?" to independent tracking of multiple bank accounts, credit cards, building society accounts and cash in hand. The only reason for keeping home accounts in any form is to have your current financial state apparent on demand and reconcile statements received in order to find out where the money goes. This program is designed expressly for these requirements. You wouldn't keep them if these areas were of no concern, and being of concern you want to keep them thoroughly and effectively. HMS HOME ACCOUNTS allows this.

HMS VAT TRADER'S LEDGER, on the other hand, fulfills a different requirement. Instead of emphasizing analysis, the VAT trader wants to record all his invoices and bills in the least time possible consistent with making out the quarterly VAT return and getting a well presented ledger listing on demand. Varying and multiple VAT rates are of course catered for. Add the facility to maintain period totals on user-defined bases other than VAT quarters (such as weekly, monthly and to the end of each trading account), and HMS VAT TRADER'S LEDGER should be a boon to you as a sole trader through to the low transaction company.

Both systems allow for 1000 to 10000 records per file depending on configuration and use, and initialise on shift-BREAK without user OS intervention. Fully documented source listings and optional user-modifiable VIEW text operating documentation are included on the master disc, and hard copy manuals are provided.

HMS BASIC ENVIRONMENT is specifically an aid to BASIC program development designed to encourage the creation of well structured readable code in circumstances where memory becomes a constraint. Procedures to handle screen I/O, cursor switching, CLI invocation, and keyboard validation are provided, with a linking BASIC source file compressor which includes variable name compression to two bytes. The ability to link as many BASIC source modules as desired into a single condensed running version resolves the coder's conflict between space and intelligibility; 60% compression is effected on our sources for the above accounts packages.

The disc, manual and information contained are sold under license subject to the condition that they are for single user single site application by or on behalf of the purchaser, are not for resale in whole or in part either as originals or copies, and may not be supplied to a third party as part of a package or used as part of a package supplied by a third party to the purchaser, without the written consent of the copyright holders. Damages will be claimed where this occurs, with revocation of license. Purchase indicates acceptance of license terms.

I enclose £..... for the following products (tick and delete where appropriate)

HMS HOME ACCOUNTS	(£28.75)
HMS VAT TRADER'S LEDGER	(£21.50)
HMS BASIC ENVIRONMENT	(£14.50)

VAT, disc, manual, post and packing inclusive.

The credit card companies 4% take precludes our offering their service.

Please supply on 40/80 track disc. I have VIEW/WORDWISE; OS 1.0/1.2, BASIC I/II

Name

Address

Postcode

Telephone.....

Date.....

Please send with cheque or postal order to: Harris McCutcheon Systems, 40 Huntingdon Street, London N1 1HM (01 609 3207)

DISC DRIVE OWNERS!

Still playing games?

Realise the potential of your DISC DRIVES

Learn to handle

RANDOM ACCESS FILES

and start creating for yourself

AN
INTRODUCTION TO
RANDOM ACCESS FILING
ON THE
BBC MICRO

This 101 page publication is available NOW and is supplied complete with DEMONSTRATION DISC (40 track) containing an example STOCK CONTROL system and a PERSONNEL system.

Price £12.50 complete
MISSING - PRESUMED LOST ...

Your favourite program is deleted from your disc by accident -
But WAIT!

UTILITIES 1 is the answer -
two programs designed to help you.

1. DISCMAP

A unique 'picture' of the contents of your disc helps you to spot where 'missing' programs are waiting to be recovered. Incorporates full details of all catalogued programs and a PRINTER option.

2. DELETED FILE RECOVERY

Helps you recover ALL or PART of a deleted BASIC program or Machine Code program. INVALUABLE for recovering data from discs with corrupted catalogues. Incorporating a SECTOR SEARCH which will display sector contents in a uniquely readable way!

Supplied on disc (40 track)

£8.95 complete with FULL DOCUMENTATION
THE COMPUTER ROOM
206 MAIN STREET
NEWTORPE, NOTTS.

Now, the adventure game that's so advanced, it can be played on two micros.

Push your Beeb to its limits with Magic's new GALAXY'S EDGE adventure pack. On the first side there's THE DISCOVERY, a classic text-only quest. Piloting the starship Orion, your vital mission is to explore alien civilizations to discover priceless technological artifacts from the long-dead First Empire of Earth.

Now flip the tape over, invite a Beeb-owning friend around, and experience ESCAPE FROM SOLARIS, the first adventure program that can be played on TWO BBC micros. Link them up with a normal RS 423 lead, load the programs and you're both roaming the universe in a dangerous, exciting quest - do you cooperate or compete, follow him or fight him? Can he be trusted??? To appreciate ESCAPE FROM SOLARIS fully you need two BBC micros, series 1 operating system, model B (or model A with 32K and RS 423 upgrade) and an RS 423 lead. However the program can be played by 2 people on one micro, and you can even enjoy ESCAPE FROM SOLARIS on your own, as there is a one player/one micro option too.



Incredibly there's more! Included free on this action-crammed tape are a suite of RS 423 utilities to help you get the most out of your RS 423 lead.

Magic's complete "GALAXY'S EDGE" Adventure pack tape costs £7.45 including free instruction sheet, 2 function key strips, and p. & p. A 1.5 metre RS 423 lead can be supplied for £2.50 inc. p. & p.

Send cheque with order to:
Magic Software Ltd., Dept. A2,
Elmswell, Bury St. Edmunds, Suffolk IP30 9HG.

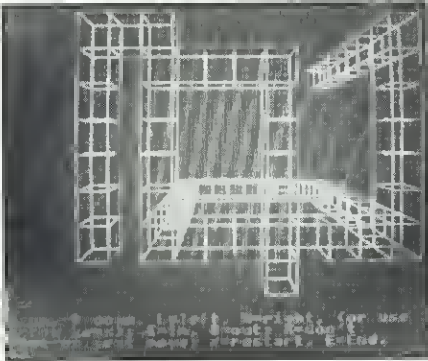

'Build' in action. The cursor control positions squares of a fixed size around the screen

answers, but the use of the program in reinforcing the skill of subtraction and the importance of place value are clear. *Ergo* displays a 5x5 grid with two numbers filled in, and you have to discover the rule which connects the 25 numbers.

The function graph plotter (FGP) is versatile and efficient. Illustrated here are the graphs of yx^n for varying values of n (figure 2).

Dicecoin, as the name suggests, simulates repeated dice rolling or coin tossing and displays the data in a variety of ways. It is no substitute for pupils performing their own experiments and would be more useful if it catered for the tossing of more than two coins together as then it could reproduce experiments which are impractical in most classrooms.

Solve turns the computer into a cal-

culator for linear equations of the form $ax + b = cx + d$, and shows clearly the effects of adding 7 to both sides of the equation, say, or dividing by 2.

Moves demonstrates the effects of linear transformations and includes the possibility of defining your own matrix. *Takehalf* is a fascinating program which runs like a film for about ten minutes showing a square which is shaded in constantly changing ways so that half the square is black and half is white.

Finally, *Track* is a picture-drawing language, based on Papert's Logo. A brief example will show the power of the program. The following six instructions define a pentagon, and whenever the instruction PENTA is typed, the shape is drawn on the screen:

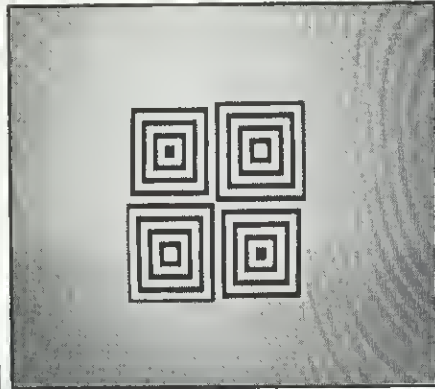

Freeze-frame from 'Takehalf', a 'film' in which the shading within a square changes

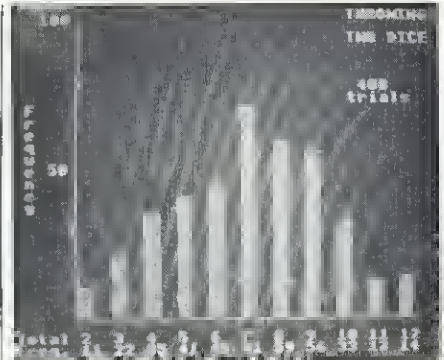

'Dicecoin' simulates dice-throwing and coin-tossing, displaying the results graphically

```
DEFINE PENTA
REPEAT 5
FORWARD 30
LEFT 72 (degrees)
NEXT
END (of definition)
```

The pattern of figure 3 is produced by:

```
REPEAT 8
PENTA
LEFT 45
NEXT
```

ATM's set of programs are extremely robust, are easily used by pupils and teachers—even if they have not touched a micro before—and have applications not only in the secondary school but also in primary schools and at home, not to mention the staffroom.

READ/WRITE PROGRAM

◀page 111

tutor can let them do so. When the tutor releases the space bar the computer chooses a word at random from the ones in its DATA statement (lines 1000-1040) and shows it on the screen. The students have to read it and the tutor tells them if they were right. The students will soon get faster and then the tutor needs to say anything only when they have made a mistake. When the tutor has had enough of pressing the bar the students can have a go. This point 1 of the check-list is satisfied, which it would not be if the computer flashed up words at fixed intervals. Points 2 and 3 are satisfied by default, since the tutor does the marking, not the computer. Point 4 does not apply and point 5 is clearly satisfied.

There is one point about how the program works that is worth making. The computer selects the words by generating a random number and then displaying the corresponding word. (For example, if it came up with the number 2 it would

display the word in the second DATA statement.) It is possible for the computer to generate the same number several times in a row, which would mean that the same word would keep coming up and the students would get bored. So I included line 490, which makes the computer generate a new random number if it generates the same one three times in a row, and so the same word never appears on the screen more than twice in succession.

This is an example of the kind of unexpected problem that can arise when writing computer programs. These problems are not always spotted by the

'More programs need to be written for adult literacy lessons. The important thing is to put yourself in the students' place and not to make them use a program you wouldn't use yourself'

programmer and so a program should not be assumed to be satisfactory until it has been successfully used a few times.

Other programs that could be tried include versions of Hangman and various word-finding games. A type of program that has potential is the word processor. It allows you to type in your text like a typewriter, except that it automatically starts a new line when the right hand margin is reached. If you need to correct your text you can insert any number of words anywhere in the text, and the rest of the word are automatically moved to make room.

The advantage to the students in doing their work this way is that it is always neat and tidy, and the tutor can correct it without the corrections showing. Note that the word processor also satisfies the points in the check-list, provided the tutor is present to satisfy the feedback requirement of point 3.

I have described how a computer can be used as an aid in adult literacy lessons without it taking control. More programs need to be written and my five-point check-list gives an idea of what is required. The most important thing is to put yourself in the students' place and not to make the students use a program you wouldn't use yourself.

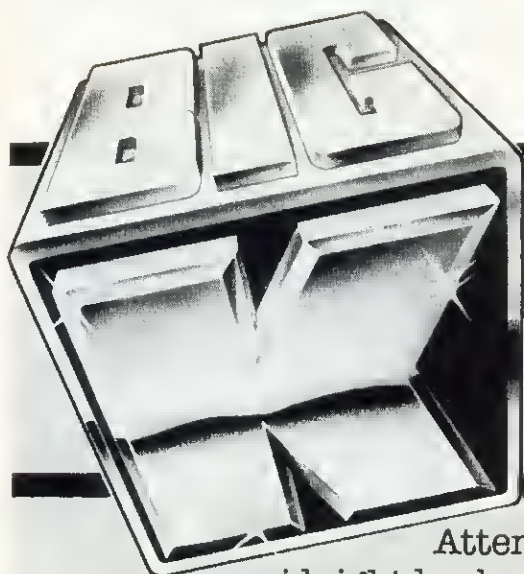

THE NEW COMPUTER GAMES MAGAZINE THAT BREAKS ALL THE RULES

Attention all you pixel-packers, midnight hackers and binary-bustin' bozos! Gorf's gift to gamesville has just hit the streets. Big K's the name and Big K's the game – it's a new magazine that's going to be music to your micros. Whatever Big K gets in its sights – technical, tactical or just plain old topical, don't expect anything typical. Big K **plays** it different and **says** it different. We're not afraid to shoot from the hip – and we're always hip when we shoot! We've a no-holds-barred approach to arcade strategy and adventure that'll have your CRT's tingling. Key in to Big K now for a magazine that puts news, reviews, programs and hardware under your fingertips. **After your first byte of Big K... the game will never be the same.**

THIS ISSUE: Modem Living – access the world through your micro and telephone – Big K makes the right connections.

- Win a full-sized BATTLEZONE arcade game in Big K's extravagant competition.
- What's all the fuss about? Big K examines the 68000 wonderchip.

- Atari 800XL review.

- 7 games programs for Commodore 64, Vic 20, BBC, Spectrum, ZX81, Oric, Atari.

- Atari graphics – read Big K's special feature.

Plus – Arcade Alley, dozens of games reviews, expert technical features, lots of fun and lashings of colour.

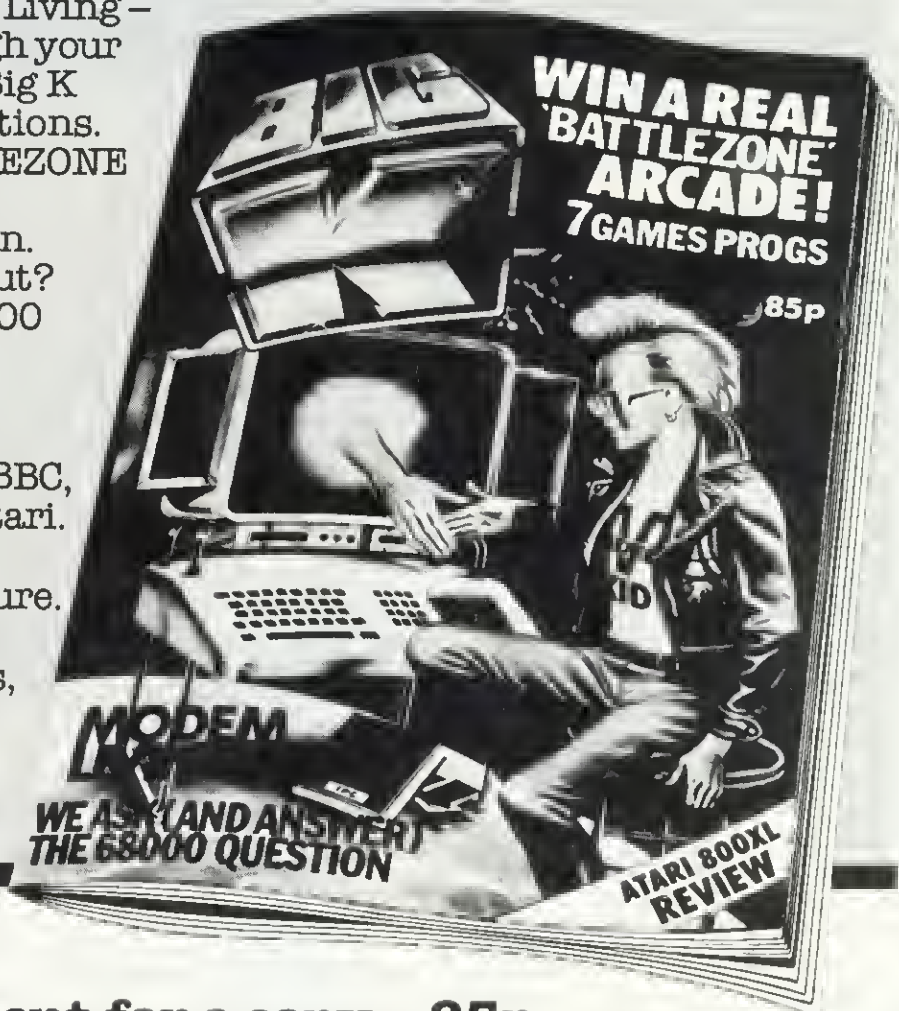

Third amazing issue on sale 17th May

Ask your newsagent for a copy – 85p

**RING FOR SAMPLE PRINTOUT, FULL SPECIFICATIONS & LATEST PRICES
BEST PRICES ON STAR AND JUKI PRINTERS**

JUKI 6100 DAISYWHEEL PRINTER



One Year Warranty
18 CPS : BiDirectional & Logic Seeking
10, 12, 15 & Proportional Spacing
Wordstar Compatible
2K Buffer : 13 Inch Platen
Underline : Backspace + Lots more
Centronics Interface Standard
RS 232 Interface £54.00 + VAT Extra
Tractor Feed £99.00 + VAT Extra

JUKI6100 £365.22 + £54.78 VAT = £420.00

**BBC/ORIC or DRAGON Package
JUKI 6100 + Cable +
24HR Delivery & VAT £440.00**

STAR GEMINI 10X

UPDATED
STAR
DP510



One Year Warranty
True Descenders 9 x 9 Matrix
120 CPS Bidirectional & Logic seeking
5,6,8.5,10,12,17 cpi 40,48,68,80,96,136 cpl
Italics, Emphasized, Double strike, Super & Sub Scripts
Hi-Resolution & Block Graphics
Continuous Underline, Backspace
Downloadable Character Set
Friction or Tractor Feed
Centronics Int. Std.
RS232 int. £52 + VAT EXTRA

Star Delta 10
160 CPS
Centronics and
RS 232 Int. Std.
8K Buffer
£320 + VAT

**GEMINI 10X (10" CARRIAGE)
£235 including VAT**

**PACKAGE FOR BBC/DRAGON/ORIC
GEMINI 10X + CABLE + DELIVERY
BBC SCREEN DUMP SOFTWARE & VAT
£255 including VAT**

**STAR DP515 (15" CARRIAGE) £390 Inc. VAT.
RING FOR LATEST PRICING**

STAR DP8480



RS232 INTERFACE STANDARD
7x9 Character Matrix (7 Needle Head)
80 CPS Bidirectional & logic seeking
5,6,8.5,10,12,17 cpi
40,48,68,80,96,132 cpi
Friction & Tractor Feed: 10 Inch Platen
Hi-Res option with Software £10.00/15.00

**DP8480 with RS232 Int. £180+
£27.00 VAT = £207**

**Package prices for BBC/Newbrain/Epson HX20
DP8480 + Cable + Hi-Res + 24Hr Delivery &
VAT = £227**

SERIAL PRINTER CABLES

BBC to 25 way D type	£9.50
EPSON HX20 to 25 way D type	£9.50
NEWBRAIN to 25 way D type	£12.00
25 way D type to 25 way D type	£15.00

OFFICIAL ACORN DEALER

ACORN ELECTRON	£199.00
BBC Micro Model B	£399.00
BBC Micro Model B with Disc Int	£469.00

Large range of Accessories including Disc Drives, Printers,
Monitors always in stock

Printer Cables

BBC to 36 Way Centronics Type Connector	£15.00
Dragon to 36 Way Centronics Type Connector	£15.00
Oric to 36 Way Centronics Type Connector	£15.00
Torch to 36 Way Centronics Type Connector	£20.00

Blank C15/C30 Cassettes Ten for £4.50 ANY MIX
Send SAE for Full Price List

VAT INCLUDED WHERE APPLICABLE

PHONE/CREDIT CARD ORDERS WELCOME

Postage 50p per order or as stated
24 HR Securicor Delivery for Printers/Disk Drives £8.00
Shop/Workshop Closed Mondays

**C.J.E.
Microcomputers**

Dept (AU), 78 BRIGHTON RD
WORTHING
W. SUSSEX BN11 2EN
(0903) 213900

PHILIPS 14" COLOUR MONITOR/COLOUR T.V.

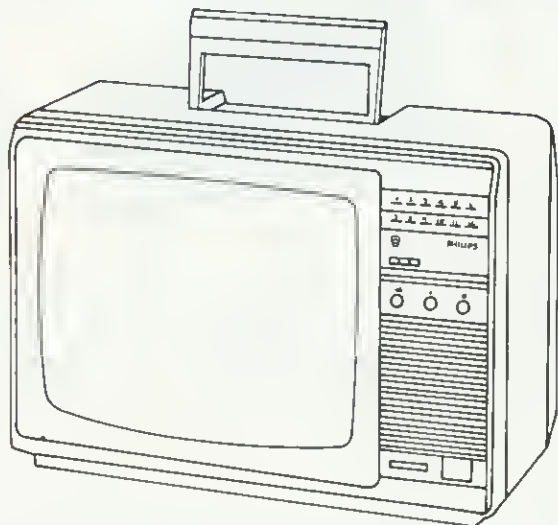

- Sparkling picture in seconds.
- Reliability and performance excellent.
- Headphone Socket, can also be connected to tape recorder.
- Loudspeaker mute switch.
- Retractable carrying handle.
- Metallic silver finish with restful dark picture surround.
- Includes RGB lead connecting direct to your BBC Micro.
- **£235 inc. VAT.**

See the Viglen full page ads to order: Viglen Disk Drives, Printers and the other monitors featured.

Viglen
COMPUTER SUPPLIES

Unit 7, Trumpers Way, Hanwell W7 2QA. Telephone: 01-843 9903.

NEW!

from

Viglen
COMPUTER SUPPLIES

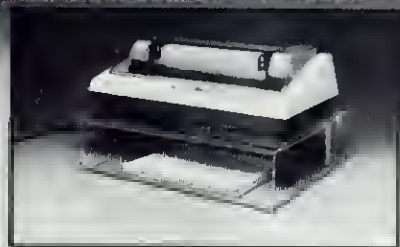

Printer Stand

£12.95 INC. VAT

Carriage & Packing £2.00

A PRINTER STAND

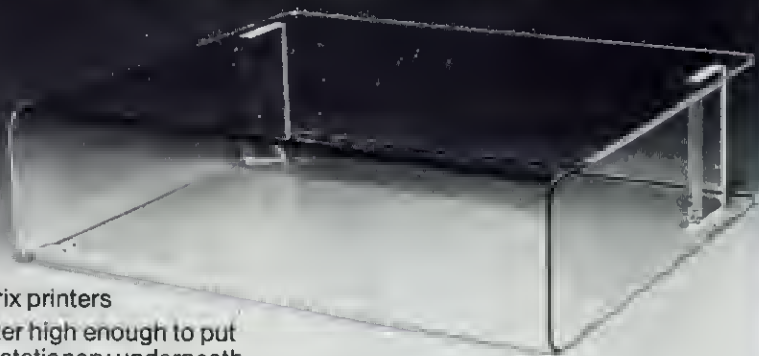

- For dot matrix printers
- Raises printer high enough to put continuous stationery underneath
- Beautifully finished in clear perspex ● Viglen quality every time
- Will accept paper up to 12½" wide ● Non slip rubber pads

Dimensions: 15" (380mm) wide 12½" (320mm) deep 4" (90mm) high

COME TO VIGLEN FOR A FAST, FRIENDLY, PERSONAL SERVICE

To order, complete and send form, or ring
VERONICA, CAROLINE OR CATHY Now on 01-843 9903

Post to: VIGLEN COMPUTER SUPPLIES, UNIT 7, TRUMPERS WAY, HANWELL, LONDON W7 2QA.

Please send me _____ (qty) PRINTER STANDS at £14.95 each. I enclose Cheque/P.O. for £_____ made out to

VIGLEN COMPUTER SUPPLIES or debit my ACCESS/BARCLAYCARD No. _____

Name _____



Signature _____

Address _____

ATOMIC LISTS ON THE BEEB

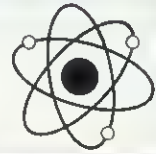

How the BBC takes on board

Atom programs, by Vincent Fojut

memory than a similar BBC Basic construct, it greatly simplifies the operation of the Atom's List.

121

MANY readers with access to both the Beeb and Atom will have been experimenting with the intercommunications programs in the December '83 *Acorn User*. Although there are many potential uses for the routines, their main purpose was to allow Atom files to be stored on disc via a BBC micro. This in itself presents no difficulties. A file is transferred to a given address on the Beeb, then stored to disc with the *SAVE command.

However, once an Atom file is loaded into the Beeb it is often useful to be able to list the program on the BBC's screen to verify that the transfer has executed successfully. Or perhaps you might want to print on a device permanently connected to the Beeb - for example, a serial printer, which cannot be used directly with the Atom. The problem is that it is not possible to use the BBC's LIST command to list an Atom file directly, since the two dialects are stored in different formats.

Tables 1 and 2 compare how a simple Basic program is stored on the BBC micro and Atom respectively. The dialects have one or two features in common. First, all lines start with a value of &D; following immediately, line numbers are stored as 16-bit binary values (high-byte first, contrary to 6502 convention); and the end of the program is marked in both cases with a byte of &D immediately followed by a negative-value byte (usually, but not

necessarily, &FF). This also accounts for the maximum line number limit of 32767 - anything larger creates a negative high byte, which would be misinterpreted as the end of program text.

However, that is more or less where similarities end. Line numbers in BBC Basic precede a single byte giving the length of the current line, including &D, line number and length byte itself (which speeds up those processes that need to scan through a Basic program, such as RENUMBER). Also, Basic commands such as "PRINT" and "END" in the example, are stored as single-byte tokens. While this ensures BBC Basic is relatively compact (and fast), it complicates the requirements of the Beeb's LIST command, since it needs to convert the tokens into an intelligible, ASCII string form. Regardless of whether the command is entered on the Beeb in complete or abbreviated form, it will always be converted into a single-byte token and is always reconverted into its 'fuller' format when listed.

By contrast, commands are held on the Atom (along with the rest of the line) exactly as entered, i.e. "P" will take up two bytes, while "PRINT" takes up five. Although this generally consumes more

in Basic refers to a series of ASCII characters terminated by a carriage return (&D), it follows that Atom Basic files may also be looked at as a sequence of strings, separated by 16-bit binary line numbers. Once an Atom file is perceived in this way, it becomes surprisingly easy to write a suitable program for listing them on the Beeb, as shown in program 1. The program assumes that an Atom Basic file has been transferred to a given location in the Beeb's memory using, for example, December's communications programs.

The main program loop is from lines 220 to 280. Each line number is converted and printed, then the following line of text is accessed and printed as if it were any other Basic string, using the string indirection operator, \$. This process is repeated until the negative byte, marking the end of program text, is detected (line 280). Line 250 prints a space after each line number, if this option has been selected at the start of the program. (For more extensive Atom program formatting, see March's *Acorn User*.) The output may also be directed to an appropriate printer channel.

Apart from its obvious uses in listing Atom files on BBC-dedicated printers, the routine can also serve as a useful first step in the conversion of Atom programs to

page 127 ▶

Program 1. Lists Atom Basic files on the Beeb

```

10 REM Atom Basic lister for BBC micro
20 REM (C) V. FOJUT, 1984.
30
40 T%=0%: REM save Print format
50 B%=5: REM new Print format
60
70 REPEAT
80 INPUT "ADDRESS OF ATOM PROGRAM",start#
90 Pointer=EVAL(start#)
100 IF ?Pointer<>&D PRINT "BAD ADDRESS"
110 UNTIL ?Pointer=&D
120
130 PRINT "SPACE AFTER LINE NO.(Y/N)?"
140 PROCyesno
150 IF yes sSpace=TRUE ELSE sSpace=FALSE
160
170 PRINT "OUTPUT TO PRINTER (Y/N)?"
180 PROCyesno
190 IF yes THEN VDU3
200
210 Pointer=Pointer+1
220 REPEAT
230 LineNo=(?Pointer)*256+Pointer?1
240 PRINT LineNo/
250 IF sSpace PRINT " "
260 PRINT $(Pointer+2)
270 Pointer=Pointer+3+LEN$(?Pointer+2))
280 UNTIL ?Pointer>&TF
290 VDU3: REM disable Printer
300 B%=T%: REM restore Print format
310 END
320
330 DEFPROCyesno
340 yes=FALSE
350 REPEAT
360 reply# = GET#
370 UNTIL INSTR("YNn"),reply#)
380 IF reply#="Y" OR reply#="y" yes=TRUE
390 ENDPROC
    
```

What the competition hasn't been waiting for.

Latest version of Forth for the BBC
(Is not rehashed Forth 79 Code)

Unique Stack Display Utility



16k Eprom type 2712B

Multi-tasking operating system
for Real-Time use.

Here's the Forth Eprom for the BBC Micro that makes all others out of date.

It's Multi-Forth 83 from David Husband who has built his reputation for Quality Forth products with his ZXB1-Forth ROM, Spectrum Forth-I/O Cartridge and now New Multi-Forth B3 for the BBC Micro. This is not rehashed Forth 79 Code, but a completely new version of the Forth 83 Standard. It's unique in that it Multi-tasks, and therefore the user can have a number of Forth programs executing simultaneously and transparently of each other.

Multi-Forth 83 sits in the sideways ROM area of the BBC along with any other ROMs in use. It is compatible with the MOS, and specially vectored to enable a system to be reconfigured. It contains a Standard 6502 Assembler, a Standard Screen Editor, and a Unique Stack Display Utility.

With this Forth, David Husband has provided the BBC Micro with capabilities never before realised. And being 16K rather than 8K is twice the size of other versions. Multi-Forth 83 is supplied with an

extensive Manual (170 pages plus) and at £40+VAT it is superb value. Order it using the coupon adding £2.30 p&p (£5 for Europe, £10 outside) or if you want more information, tick that box instead. Either way, it will put you one step ahead of the competition.

Please send me Multi-Forth 83 for BBC Micro £40+VAT De-luxe System inc. Disc £80+VAT
Cheques to Skywave Software Readers' A/C (or enter Visa No.)

Name _____
Address _____
Post code _____

Please send me more information
 Multi-Forth 83
 ZX81-Forth ROM
 Spectrum Forth-I/O Cartridge

Skywave SOFTWARE

SUBJECT TO AVAILABILITY FOR 1.005 ONWARDS
Send to Skywave Software, 73 Curzon Road, Bournemouth,
BH1 4PW, Dorset, England Tel: (0202) 302385

MULTI-FORTH 83 FOR THE BBC MICRO

Sequential Software

P R E S E N T S

Kernel One

- an exciting new development for the BBC (32K) micro

KERNEL ONE PROVIDES

- cassette containing fully documented assembler source code for an interrupt driven multi-process scheduler
- working three process example program
- comprehensive user guide including principles of professional multi-process systems
- clear illustration of the full power of the BBC's built-in assembler
- high educational and practical value

Written by a professional software engineer, KERNEL ONE enables you to learn about MULTI-TASKING systems by building your own multi-process assembler programs in a simple structured way on the BBC microcomputer.

Send Cheque/PO for £12.95 (inc. p & p) to:

SEQUENTIAL SOFTWARE
(Dept. A), PO Box 141, Cheltenham, Glos. GL50 4TQ.

737 FLIGHT SIMULATOR



Written by a professional 737 pilot, this comprehensive simulator was originally designed as an aid to practice in instrument flying.

Performing to the specifications of a modern high performance jet airliner, the 737 Simulator was written specifically for the BBC Micro, and affords the following features:

- * Accurate and detailed flight deck layout with both analogue and digital readouts.
- * Colour Hi-res graphics and sound.
- * Three-dimensional take-off and landing sequences.
- * Radar plot of aircraft in mid-flight.
- * Option of resetting stall speed, for beginners.
- * Instrument Landing System (ILS) and Ground Proximity Warning System (GPWS).
- * Simulated Engine Failure.
- * Use of preset runway layout, or design your own.
- * Set up your own atmospheric conditions (e.g. crosswinds).
- * Accurate limitations and variations according to height and atmospheric conditions.
- * Three radio navigation beacons.
- * Flight Manual, including diagrams and a flying lesson.

Instruments include: ● Compass ● Artificial Horizon ● Altimeter ● Vertical Speed Indicator ● Air Speed Indicator ● GWPS ● Radio Beacon Indicators ● ILS ● Engine Power Indicator ● Fuel Gauge ● Stopwatch ● Flap Indicator

Price £9.95

Please add 50p p&p to all orders. Send A5 SAE for full catalogue.

Cheques or postal orders payable to:

Salamander

SOFTWARE

17 Norfolk Road, Brighton BN1 3AA

Other titles available for the BBC Model B

EDG Graphics Package

A sophisticated technical drawing package.

Tape Version £19.95

Disc Version £24.95

All products compatible with all operating systems.

BBC Utilities Package:

Sound Shaper, EDG Epson Screen Dump, Teletext Screen Editor, Disassembler.

£9.95

French Tutor:

Tests Vocab, speech idioms and irregular verbs; 1000 word vocabulary; full accenting capability; create your own files; progress assessment and revision list available at any time.

£9.95

NOW
Available on the ELECTRON
and for the BBC on DISC

Barry Pickles lists the new 6502 instructions – plus the quest for the random number, sideways scrolling techniques, Basic bugs

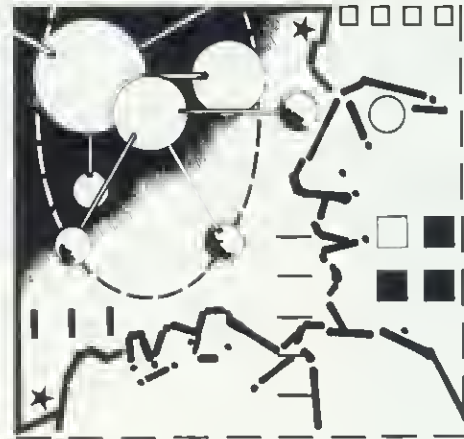

124

The new

6502 op-codes

AS PROMISED last month, here are details (opposite) of the newly discovered instructions for the 6502 processor. They are laid out in the usual format, but you should note that these codes are undocumented by Mostek and, if you want to use them, you will have to 'hand-assemble' them, since no mnemonic assembler/disassembler will recognise them.

However, they do work and, as well as providing some new operations and addressing modes, save both memory and time.

The saving, in each of the dual-operators, relates to the second operator. That is to say, the number of bytes saved is exactly the number that would have been required by the second operand, and the processing time used is that of the first operand *plus* one cycle. Table 1 gives the memory and timing figures for all the dual-operator instructions.

You will need to take care if your program tests the state of the flags, since, although the flags affected are shown, the same flag may be affected by each 'half' of the operator, depending upon what you are doing. The rule is that the flags will be affected in the same manner as if you

Addressing mode	Bytes used	Cycle time
Zero page	2	6
Zero page, X (Indirect, X)	2	7
(Indirect, Y)	2	10
Absolute	3	7
Absolute, X	3	8
Absolute, Y	3	8
Immediate	2	2

Table 1

Invented a routine or discovered a hardware modification for the Atom? Here's a chance to show your originality and win some cash. Send your idea to: Atom Forum, Acorn User, Redwood Publishing, 68 Long Acre, London WC2E 9JH.

had used separate operators. The HALT instructions are included only for completeness – I can see no practical use for them, as only a hard reset (ie, pressing BREAK) has any effect after this instruction.

Out of a possible 255 instructions, we now have only eight unused. These are 64/83/93/9B/9E/AB/BD/D4. Some of them appear to do something, but the effects seem unpredictable. Finally, note that all numbers are in hex.

NOW WE ARE ONE!

WITH this issue 'Atom Forum' is one year old, so I would like to thank all those who have contributed to this column during that time. However, I've noticed a decrease in the number of submissions recently. Surely we haven't said everything there is to say about the Atom? Remember, this is *your* column, so keep 'em coming!

Basic bugs

M CONSTANTINE of East Grinstead writes with a note of two bugs in AtomBasic.

If you wish to transfer data between programs then the array in which it is stored can be positioned in memory so that when the second program is loaded it doesn't overwrite the data. This is done by POKEing the free space pointer #23 and #24 with the starting address of the array. If the identical address is used in both programs and an identical array dimensioned in each the data will remain intact.

The problem arises when two or more arrays are needed. In these cases element 0 of the second and subsequent arrays will be corrupted. This is because the interpreter checks that it has not run out of space by writing and reading to the first memory byte past the end of the array being dimensioned.

There are two solutions. The first is not to use element 0 and the second involves repositioning the free space pointer after dimensioning each array, either by leaving a lot of space between the two arrays or by adding 1 to the pointer after dimensioning each array to skip over the

corrupted byte, thus:

```

10 ? ##23 = 0; ? ##24 = ##82
20 DIM AA(N)
30 ? ##23 = ? ## 23 + 1 ;
   IF ?## 23 = 0; ? ##24=
   ?##24+1
40 DIM BB (N)
50 REM REST OF YOUR PROGRAM
    
```

The second bug concerns the use of spaces in basic programs. Try this one:

```

10 %A = 6.55
20 %B = -%A; REM NO SPACES
30 %C = - %A; REM NOTE THE
   SPACE
40 %D = 10-%A; REM NOTE NO
   SPACES
50 %E = 10 - %A; REM NOTE
   THE SPACE
60 FP.%A'%B'%C'%D'%E
70 END
    
```

When run, %C will have the wrong value, but the rest are correct.

This tip earns Mr Constantine £5.

Practically

random

A SOLUTION to the problem of 'genuine' random numbers on the Atom is offered by Dirk Wriedt of Kappeln, West Germany, who wins £5.

The random numbers produced by the Atom's random number generator are not really random. If you are dissatisfied with that and have a VIA fitted, this is the solution: use timer/counter 2 (#B808). The timer continuously decrements at 1Mhz, as long as bit 5 of the auxiliary control register (#B80B) is set to 0.

When the counter reaches zero, it recommences at its maximum count, 65535. You might stop it by setting bit 5 of the ACR to 1 (then the counter decrements on each low-going pulse on PB6, and if there are no pulses, the counter does not count).

If you now need 'real' random numbers, you can feed the generator with the

NEW OP-CODES

ASL ORA shift left memory one bit then OR Acc with result
 Operation: C 7 6 5 4 3 2 1 0 0; A:A V M NZC1DV

ROL AND rotate left memory one bit then AND Acc with result
 Operation: C 7 6 5 4 3 2 1 0 C; A:A & M NZC1DV

LSR EOR shift right memory one bit then EX OR Acc with result
 Operation: D 7 6 5 4 3 2 1 0 C; A:A M NZC1DV

RDR ADC Rotate right memory one bit then add result to Acc
 Operation: C 7 6 5 4 3 2 1 0 C; A:A + M NZC1DV
 *** *

LDX LDA load both X register and Acc with memory
 Operation: X A M NZC1DV
 **

DEC CMP decrement memory by one then compare result with Acc
 Operation: M: M-1; A M NZC1DV
 ***-

INC SUB Increment memory then subtract result from Acc
 Operation: M: M+1; A A M NZC1DV
 *** *

ROL-ORA rotate left memory one bit then OR Acc with result
 Operation: C 7 6 5 4 3 2 1 0 C; A: A V M NZC1DV
 *** -

AND LSRA AND Acc with data then shift right one bit
 Operation: A: A & M; A: 0 7 6 5 4 3 2 1 0 C NZC1DV
 D** -

LXA AND transfer X reg. to Acc then AND Acc with data
 Operation: X A; A A & M NZC1DV
 **

STZ store zero in memory; A,X and Y unaffected
 Operation: M: 0 NZC1DV
 *

SAX AND Acc with X reg. then store result in memory
 Operation: A: A & X; A M NZC1DV
 **

SbX AND Acc with X reg. then subtract (WITHOUT CARRY) data
 Operation: A: A & X; A A M NZC1DV
 ***- *

NOP xy wait 2 cycles; ignore byte following

NOP xxx wait 3 cycles; ignore both bytes following

HALT disable processor until reset (see text)

The following codes are duplicates of existing op codes and are included here only for completeness:

Addressing

Zero (07) Zero,X (17) Ind,X (03) Ind,Y (19)
 Abs (10F) Abs,X (1F) Abs,Y (1B)

Zero (27) Zero,X (37) Ind,X (23) Ind,Y (39)
 Abs (2F) Abs,X (3F)

Zero (47) Zero,X (57) Ind,X (43) Ind,Y (59)
 Abs (4F) Abs,X (5F)

Zero (67) Zero,X (77) Ind,X (63) Ind,Y (79)
 Abs (6F) Abs,X (7F) Abs,Y (7B)

Zero (A7) Zero,X (B7) Ind,X (A3) Ind,Y (B9)
 Abs (AF) Abs,Y (BF)

Zero (C7) Zero,X (D7) Ind,X (C3) Ind,Y (D9)
 Abs (CF) Abs,X (DF) Abs,Y (DB)

Zero (E7) Zero,X (F7) Ind,X (E3) Ind,Y (F9)
 Abs (EF) Abs,X (FF) Abs,Y (FB)

Abs.Y only (3D)

Imm. only (AB)

Imm. only (8B)

Abs. only (9C)

Zero (87) Abs (8F) Abs,X (9F) Zero,Y (97)
 N.B: This instruction takes 3 extra cycles

Imm. only (CB) takes 5 cycles

Any of the following codes: 04/14/34/44 54/74 80/89/F4
 Bytes: 2 Cycles: 2

Any of the following codes: 0C/1C/3C/5C/7C/DC/FC
 Bytes: 3 Cycles: 3

Any code (except A2) whose LSB is 2

AND (Imm): 0B or 2B
 SUB (Imm): EB
 NOP 1A 3A: 5A: 7A DA/FA

StarBASE... a new database

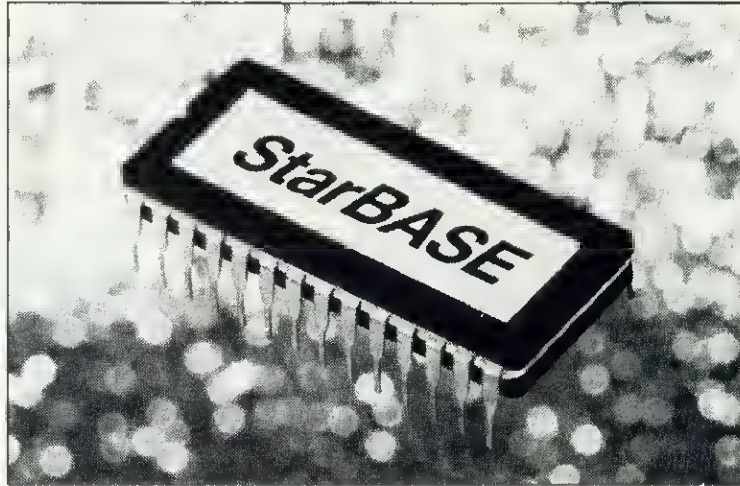

StarBASE... for the BBC

StarBASE is a *fast* random-access disc-based machine code database resident in a 16K ROM. Written by a highly qualified school-teacher to meet a *defined need* it is capable of handling 4096 records in any one file.

It is absolutely ideal for use in schools, clubs and small businesses. Normally, the only limitation tends to be the capacity of the disc drives employed (an 80 track double-sided disc drive gives a file length of approximately 400K).

- Up to 69 fields in a record
- Up to 255 characters in a field (subject to a maximum of 920 characters in a record).
- Fields can be placed anywhere using the BBC's editing keys
- A super fast Shell-Metzner sort routine is employed (numeric or alphanumeric);
- Searches possible on any field up to a depth of 5 characters anywhere within the field
- Searches on combinations of fields
- Conditional searches possible using logical operators (=, <>, >, <, or wildcards).
- Display can be arranged to automatically justify
- Security system prevents unauthorised access to data files
- Printout can be generated for such things as label formats

The need for a system that fulfils these criteria has been around for some time: *StarBASE is the answer.*

Price? Only £69.00 inc VAT (plus £1.50 p & p).



STOCK SUBJECT TO PRIOR SALE

Trade & Local authority enquiries welcome
Prices correct at time of going to press.



GCC (Cambridge) Limited
66 High Street, Sawston, Cambridge CB2 4BG
Telephone: Cambridge (0223) 835330/834641
Telex: 81594 SAWCOM

◀ page 124

contents of !#B808 at the beginning of your program, which are practically random, because it is nearly impossible for you to run your program twice at a specified count of !#B808. Setting is made by !8=!#B808.

Another solution is to use #B808 itself as the random number generator. Instead of using ABSRND%8, for example, take !#B808%8.

Before accessing the counter, make sure bit 5 of #B80B is set to 0, eg, by ?#B80B=0.

Chip famine

YOU will, no doubt, have seen the reports of a world-wide chip 'famine'. This is now beginning to affect the Atom, with supplies of the 8271 disc controller and, more seriously, 2114L RAM chips becoming hard to get. Any individual or supplier who knows of a reliable source, please get in touch with me care of the magazine so we can pass on the information.

Sideways scroll

I S JONES of Llanystumdwy, Crickieth, sent in a *Sideways Scroll* program (listing 1) that wins him £10.

This routine allows the high-resolution

```

●
● 5REM: Side-Scroll
● 6REM: I.S. Jones
● 7REM: ACORN USER-6:B4
● BREM:
● 10DIM BB6;F.I=1TO2
● 20DIMP-1;P.$21;I
● 30:BB0 LDA @#80
● 40 STA BB2+2
● 50 STA BB3+2
● 60 LOA @00;STA BB2+1
● 70 STA BB3+1
● 80:BB1 LOX @31
● 90:BB2 LOA #8000,X
● 100 ROR A;LOX@0
● 110:BB3 ROR #8000,X
● 120 INX;PHP;CPX@32
● 130 BEQ BB4
● 140 PLP;JMP BB3
● 150:BB4 LOA BB2+1
● 160 PLP;CLC;AOC@32
● 170 CMP @00;BEQ BB5
●
● 180 STA BB2+1
● 190 STA BB3+1
● 200 JMP BB1
● 210:BB5 LOA @00
● 220 STA BB2+1
● 230 STA BB3+1
● 240 LOA BB2+2
● 250 CMP @#98;BEQ BB6
● 260 INC BB2+2
● 270 INC BB3+2
● 280 JMP BB1
● 290:BB6 RTS
● 300I;P.$6;N.
● 31OREM** OEMO **
● 32OCLEAR4;F.X=0TO256
● 330%Y=X*PI/32
● 340%Z=(SIN(%Y)*50)+100
● 350Y=%Z;MOVE X,Y
● 360ORAW X,Y;N.
● 370DO LI.BB0;U.O
●

```

Listing 1. High-resolution mode 4 screen scrolled sideways

mode 4 screen (black and white) to be revolved sideways. The graphic screen is shifted right one pixel each time, while the pixels that disappear on the right of the screen re-appear on the left. Each call to the routine shifts the screen once.

The routine works by RORing (ROtate

Right) each memory location in turn and could be easily adapted to revolve only part of the screen (change lines 30 and 250). A demo is enclosed at the end of the program which revolves 0 sine curve continuously.

The routine is called using LINK BB0.

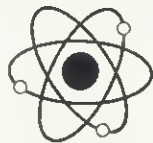

ATOM LISTS ON THE BEEB

◀ page 121

BBC Basic. The reason is simple. Now that you can list Atom programs on the Beeb, you can also generate pure ASCII files (using the *SPOOL command). These can then be fed into a Beeb-based word processor and many conversions performed automatically. Virtually all word processors have a facility to find, and optionally change, all occurrences of one

string to another. This is just what you need to alter all DOs to REPEATs, all semi-colon separators to colons, and so on. The resultant file can then be *EXECed into the Beeb and will automatically be converted into tokenised format, suitable for running directly.

If your BBC micro is not fitted with a word processor, don't despair. Use *SPOOL to generate an ASCII file from the Atom source, then *EXEC it straight back into the Beeb. This at least tokenises all commands that the BBC micro recognises. Any remaining modifications can then be done using normal editing

procedures. Although the latter option may sound tedious, it should be a good deal less time-consuming than writing the program from scratch!

Highlighting the similarities and differences between Atom and BBC Basic can only benefit both parties of users, since each can learn from the functioning of the other machine, as well as their own. If you're lucky enough to use both machines, such information is particularly relevant. Perhaps the program and techniques outlined above will help more users to get the most out of the powerful combination.

Table 1. How a BBC Basic program is stored

ADDR.	VALUE	MEANING
1900	0D	START OF LINE
1901	00 0A	LINE NO. (10)
1902	0C	LENGTH OF LINE
1904	F1	TOKEN FOR "P." (@PRINT)
1905	20 41 0A 20	ASCII: " P "
1909	F1	TOKEN FOR "PRINT"
190A	20 4C	ASCII: " B "
190C	0D	START OF LINE
190D	00 14	LINE NO. (20)
190F	05	LENGTH OF LINE
1910	E0	TOKEN FOR "END"
1911	0D FF	END OF PROGRAM.

Table 2. How an Atom Basic program is stored

ADDR.	VALUE	MEANING
2900	0D	START OF LINE
2901	00 0A	LINE NO. (10)
2903	50 2E 20 41 0A 20	REST OF LINE IN ASCII "P. A; "
2909	50 52 49 4E 54 20 42	"PRINT B"
2910	0D	START OF LINE
2911	00 14	LINE NO. (20)
2913	45 4E 44	REST OF LINE IN ASCII "END"
2916	0D FF	END OF PROGRAM.

ACORN USER

SUBSCRIPTIONS

Please start my subscription for Acorn User

from the _____ issue.

- ⁰¹
 UK £15
⁰²
 Europe £18
⁰³
 Middle East £20
⁰⁴
 The Americas and Africa £22
⁰⁵
 All other countries £24

Name _____

 Address _____

Please answer these questions to help us improve your magazine.

- 1 Do you use your micro for?:
 1 school 2 business 3 hobby
- 2 Do you have, or intend to buy, any of the following?:
 1 monitor 2 disc drive 3 second processor
 4 printer 5 modem
- 3 How many software packages do you think you will buy in the next 12 months?:
 1 0-5 2 6 to 10 3 10 or more
- I enclose my cheque/postal order/sterling bank draft payable to Redwood Publishing for £.....
 Please debit my Access/American Express/Barclaycard
 Account no. _____
- Signed..... Date.....
 Send this form, with your remittance, to the address overleaf.

EXPRESS DELIVERY

EXPRESS DELIVERY

EXPRESS DELIVERY

ACORN USER

SERVICES

SPECIAL OFFERS ON BINDERS AND SWEAT SHIRTS

QUANTITY	DESCRIPTION	PRICE
.....	RP01 Binders	@ £2.50 £
.....	RP02L Sweat shirts (large)	@ £5.00 £
.....	RP02M Sweat shirts (medium)	@ £5.00 £
.....	RP02S Sweat shirts (small)	@ £5.00 £

BACK DATED ISSUES @ £1.25 per copy

	MONTH	YEAR	
.....	AU	issue £.....
.....	AU	issue £.....
.....	AU	issue £.....
			Total £.....

Name.....
 Address.....

 I enclose my cheque/PO payable to Redwood Publishing for £.....
 Please debit my Access/Barclaycard
 Account no. _____

Signed..... Date.....

Send this form with your remittance to the address overleaf. All the above prices includes postage and packing.

ACORN USER

SOFTWARE

Please send me:

	Tape	Disc	
.....	Copies of Sword Master for BBC (32k series 1.0 OS) for Electron	£7.95	£10.95 £
.....	Copies of Trek for BBC (32k series 1.0 OS) for Electron	£7.95	£10.95 £
.....		£7.95	£

24 HOUR PHONE SERVICE (02934) 72208

DISC EXCHANGE SERVICE

Send in your copy of Trek or Sword Master with a cheque for £3.50 and we will exchange it for a disc. (Which runs on 40 or 80 tracks).

..... Tape(s) in exchange for disc @£3.50 each £



MONTHLY PROGRAM LISTING CASSETTES

Please send me a cassette of all major BBC Micro and Electronics program listings (June issue) as advertised on page 75 @ £3.75 £

Total £



Name.....
 Address.....

 I enclose my cheque/PO payable to Redwood Publishing for £.....
 Please debit my Access/Barclaycard
 Account no. _____

Signed..... Date.....
 Send this form with your remittance to the address overleaf. All the above prices include postage and packing.

EXPRESS DELIVERY

ACORN USER Subscriptions

Redwood Publishing

68 Long Acre

London WC2E 9JH

ACORN USER Services

PHS Mailing Ltd

PO Box 14

HORLEY

Surrey

ACORN USER Software

PHS Mailing Ltd

PO Box 14

HORLEY

Surrey

BBC MICRO

- USER SUPPORT -



- 10 ISSUES OF BEEBUG MAGAZINE
MAILED FREE TO MEMBERS
- 30 EXCITING GAMES AND VISUAL PROGRAMS
- 43 SOFTWARE REVIEWS
- 33 HARDWARE REVIEWS
- 16 BOOK REVIEWS
- 150 HINTS AND TIPS
- 25 APPLICATION PROGRAMS
- SERIES OF ARTICLES FOR BEGINNERS
- MANY ADVANCED TECHNICAL ARTICLES
- NEWS AND PRODUCT INFORMATION
- PLUS SPECIAL OFFERS
- BIG DISCOUNTS ON A WIDE RANGE OF PRODUCTS
- EVENTS
- BRAIN TEASERS
- LOCAL CLUBS
- FULL MAGAZINE INDEX

A YEARS SUBSCRIPTION WOULD HAVE BOUGHT YOU ALL THIS

Figures based on the 10 issues of BEEBUG Volume 2.

BUT IT'S NOT TOO LATE TO JOIN FOR VOLUME THREE

BEEBUG PUBLICATIONS LTD. PO BOX 109, HIGH WYCOMBE, BUCKS

PLEASE ENROL ME FOR VOLUME 3
OF BEEBUG AT £9.90 (10 ISSUES)

NAME

ADDRESS

.....

AMOUNT ENCLOSED

PLEASE MAKE CHEQUES PAYABLE TO
BEEBUG PUBLICATIONS LTD.
AND SEND TO:- DEPT 13, PO BOX 109
HIGH WYCOMBE, BUCKS.
(DISTRIBUTION AGENTS FOR BEEBUG)

**BEEBUG HAS BEEN
ESTABLISHED FOR TWO
YEARS AND NOW HAS
OVER 25,000 MEMBERS. IT
OFFERS TOTAL USER
SUPPORT TO ALL BBC
MICRO USERS.**



AIDS II UTILITY ROM for the BBC MICRO

An essential tool for all BBC Micro programmers - saves time and tedium in program management. 12 fully featured new functions:

- List Peruser** * Lists program: step back and forth by page or line.
- Part Renumber** * Smart Renumber specifying new start & step values.
- Line Move** * Smart Move of program lines to anywhere else in program.
- Line Merge** * Copy Lines from one program to another, or duplicate lines within program.
- BASIC pointers** * Displays values of PAGE, TOP, LOMem HMem, Program Size, Variable-TOP and Free Space.
- Disassembler** * full listing format with Hex & ASCII representations of data;
* direct disassembly of any sideways ROMs
* output can be saved to a file & *EXEC'd back for editing, relocation & re-assembly.
- Memory Editor** * display memory in Hex & ASCII, including sideways ROMs;
* shift back & forth by block or byte;
* Search for byte string - define in Hex or ASCII.
* Overwrite any section - Hex or ASCII mode.
- Search/Replace string** * search current BASIC program (anywhere in RAM);
* search string can include BASIC keyword tokens & 'wild cards';
* each occurrence highlighted within whole program line;
* direct connection to List Peruser;
* **Replace** option allows longer or shorter strings;
- Program repair** * makes any 'Bad Program' available for editing
- Variable Dump** * lists the names & contents of all non-array program variables;
- List Formatter** * lists program in easy-to-read format: automatic indents, breaks up multi-statement lines, highlights keywords etc.
- Beeper** * invokes automatic beep on all subsequent key depressions.

All main programs allow output to Printer using simple 'toggle'. Suitable for A & B models, but must be MOS 1.2.

Details on request (S.A.E). Dealer enquiries welcome.
Price, including p&p, 24-page manual with fitting instr. ... **£25.00**

Send cheque or P.O. to:
SoftSmith, 9 Back Green, HERSHAM, Surrey KT12 4HY

Disc Drive Multiplexer

- ★ NO SWITCHES
- ★ NO SOFTWARE
- ★ NO EXTRA CABLES OR CONNECTORS

This is the simple low cost alternative to buying disc drives for every BBC. This unit allows the connection of up to 4 BBC Computers to the same disc drives. The operation is total automatic because it uses one of the disc interface outputs to electronically switch between computers. The computer will simply wait for access to the drives if they are in use. All the DFs commands are used as normal. It is ideal for use in schools and offices and saves having to purchase 1, 2 or 3 dual drive for about £500 each. The unit is complete with its own power supply.

Prices: £ 75.00 + VAT for dual unit
£135.00 + VAT for quad unit.

BBC Interface Design Service

We now offer a complete design service for interfacing the BBC Computer to external equipment, e.g. analogue and digital multiplexing, motor control, and even complete experiments.

We will be pleased to quote for the complete hardware and software design and manufacture for your system.

For further details contact:

Benwick Electronics
9 Doddington Road, Benwick, Nr. March, Cambs.
PE15 0UX.
Tel: Benwick (035477) 471

BITS & BYTES

B&B disc drives include utilities, disc, manual and cables all cased in Plastisol steel by BSC which is tough, abrasion resistant, designed to withstand rough handling and is easily wiped clean. Colour near to BBC.

Single Disc Drives

40T	100k	1/2 Height	5 1/4"	£145.00+vat
40T	100/200k	1/2 Height	5 1/4"	£150.00+vat
40T	100k	1/2 Height	3"	£150.00+vat
40T	100k	1/2 Height	3 1/2"	£164.35+vat
40T	100/200/400k	1/3 Height	5 1/4"	£173.04+vat

The new double sided 1 3/16 high, super quiet, linear stepper motor with Epson reliability.

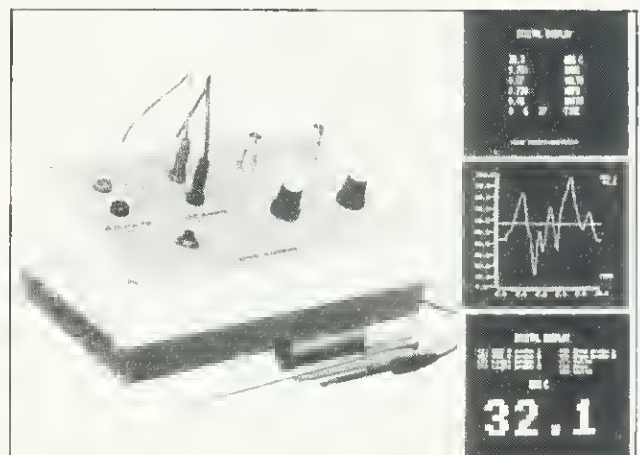

Excet EMU3

SOFTWARE SUPPORTED MONITORING INSTRUMENT—BBC MICRO

Enables the BBC (B) to measure and display accurately:
POSITIVE & NEGATIVE—VOLTS ★ AMPS ★ WATTS
★ OHMS ★ TEMP ★ LIGHT ★ TIME

FEATURES

Up to 6 simultaneous readings
Graphical or digital display
Auto scaling and labelling
Plots any two variables
Menu driven options
Full software support
Unlimited choice of scales
Event analysis facility
Teaching display mode
£99.00 inc. VAT

RANGES

Temp -10 to 110 deg C
Resistance 0 to 1E6 ohms
DC volts 40vpd
DC current 0 to 2000m Amps
Power 0 to 80 watts
Light 0 to 100 (uncalibrated)
Time 0 to 1E6 secs (hrs mins secs)
Accuracy: error generally <1 per cent

Includes instrument, temperature probe, light sensor, electrical probes (three sets), leads, connections, software on cassette, full instructions, application, notes, P&P. Free VHS video demonstration film available on request.

**BITS & BYTES
(COMPUTERS)
LTD**

**20/21 SOUTH ST
S. MOLTON, DEVON
TEL. 07695 4141**



Putting on the Ritz, Simon Dally eavesdrops on some business talk. Can you sort out the sales claims of two boastful, boozy tycoons?

DIVIDING THE SPOILS

TWO millionaires in the home computer business were chatting recently over a drink at the Ritz.

'You know,' said SCS to CC (like all true tycoons these grand people were known only by their initials), 'I can't possibly disclose my sales figures to you. But I don't mind telling you, old boy, that in the last six months the number of machines sold by my toiling serfs was exactly divisible by 13. Moreover, if you divide the number by 2 you get a remainder of 1, divide it by 3 you get a remainder of 2, divide it by 4 and the remainder is 3 - and so on until you divide by 12 and the remainder is 11.'

'By the way,' he added, 'let me know if you need a back-door entrance to Mensa. Just because you're a bit short in the old IQ doesn't mean you can't join.'

CC sipped ruminatively on another Harvey Wallbanger. 'Was the number of units you sold the lowest possible number with those particular characteristics?' he ventured.

'It was indeed,' beamed SCS.

CC took another sip. 'In that case, SCS, I'm sorry to inform you that my sales figures also obey the characteristics described by you. I'm sure you don't want to hear this, but I can assure you that my serfs sold a lot more computers than

yours - nearly three times as many, in fact. As for Mensa, I wouldn't join any club that would accept me for a member. Pip pip!'

How many computers did the tycoons sell respectively? Answers on a postcard, please, to arrive not later than 6 July 1984. Address your entries to June Competition, Acorn User, 68 Long Acre, London WC2E 9JH.

See panel for the super ROM prizes worth more than £600!

FEBRUARY COMPETITION

The February 'Magic Squares' competition produced roughly 50 entries, all but three of them correct. The correct answer was:

17	171	126	54	230	100	93	264	145
124	66	290	85	57	168	162	23	225
216	115	75	279	198	29	170	76	42
261	186	33	210	68	38	200	135	69
50	270	92	87	248	165	21	153	114
105	51	152	150	27	207	116	62	330
138	25	243	132	58	310	95	63	136
190	84	34	184	125	81	297	174	31
99	232	155	19	189	102	46	250	108

The winners were A P Selby of London and R Nagorwat of Stafford. Deepest sympathies go to Stephen Cree of Merseyside, who spent 112 hours programming his computer before coming up with the answer - he pointed out that in that time Paul McCartney had earned £282,240, whereas all he was aiming at was £20 worth of software - and to the Reverend Seed of Fort Augustus who toiled for 'many hours and days' in vain. Sometimes even the deity fails to assist RAM-wise.

- ▼ **FIRST PRIZE!**
SIDEWISE ROM BOARD, plus 4 ROMs: Wordwise, Disc Doctor, Graphics and Caretaker (Basic utility). Worth £190
- **TWO SECOND PRIZES!**
Three ROMs: Graphics, Disc Doctor and Caretaker. Worth £100
- **FIVE THIRD PRIZES!**
Choose one of these ROMs: Wordwise, Graphics, Disc Doctor, Caretaker, Printmaster (Epson-compatible), Gremlin or Termi. Worth up to £46

PRIZES SUPPLIED BY: COMPUTER CONCEPTS



M I C R O P O W E R M I C R O P O W E R M I C R O P O W E R M I C R O P O W E R M

M I C R O P O W E R

FOUR SUPERB NEW B.B.C. PROGRAMS FROM

RUBBLE TROUBLE

Crush the boulders and squish the mutant Krockots as they scavenge for food amongst the rotting ruins. Only the fittest can survive in the desolate post-nuclear wasteland. £7.95 inc. V.A.T.



STOCK CAR

Skid round hairpin bends, cutting up the competition and rebounding off the barriers to make a dash for the finishing line. A one or two player game featuring 6 different circuits, oil patches, selectable number of laps, variable skid, and keyboard or joystick control. £7.95 inc. V.A.T.



M I C R O P O W E R M I C R O P O W E R M I C R O P O W E R M I C R O P O W E R M

SCREEN TEST



134

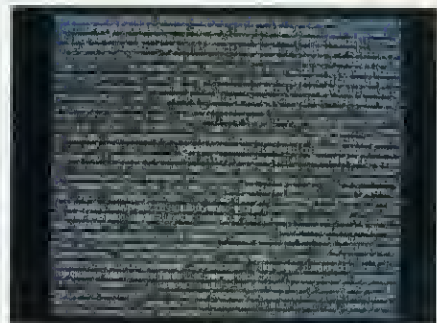

Choosing the right visual display unit (VDU) for your micro can be just as big a headache as choosing the right micro itself. The unsteady, fuzzy display on the family television soon begins to pall – as do the demands to turn back to *Top of the Pops!*

Anyone aware of the potential of his computer's graphics facility quickly realises that a monitor is essential if those lovely multi-coloured images are to be appreciated, and to read the Beeb's 80-column text on anything other than a medium to high resolution monitor for any length of time could damage your eyes.

But which monitor? The range of choice has grown extensively in recent months. It's a choice not only of brand but of the facilities on offer. I've selected four monitors for comparison that I feel represent the spectrum of choice.

To establish an objective means of comparing them I've borrowed a variety of VDU tests from a number of sources, one or two of which readers may be familiar with. The program on yellow page viii will be of use in evaluating your own VDU or any you may consider buying. It is menu-driven, allowing you to perform each of the tests at the touch of a key (press the spacebar to return to the menu).

Before we look at the monitors let's see what we are testing them for.

Test A This fills the screen with random lower case characters in mode 0. Each



The solid circle in mode 0 should be central and properly round

Chris Drage sees how two colour and two monochrome monitors cope with his nine-part test program

character should be distinct and easily read.

Test B Alternating inverse Ms and Ws. Monitors find these letters difficult to resolve. Check particularly at the screen edges.

Test C This causes the screen to flash alternately between black and white, testing whether the monitor's power supply can cope with rapid changes. The effect of the screen collapsing inwards is normal. The build-up of the white screen should happen instantly, however.

Test D There are 15 horizontal white bars printed across half a mode 0 screen. The spaces between each should be uniformly black, as should the right hand side of the screen. Uneven shades of black indicate the low frequency of the monitor.

Test E The border drawn round the screen should be straight and fit on the screen evenly on all sides.

Test F The solid circle drawn in mode 0 should be central and show no tendency to be oval.

Test G This is a severe test of a monitor's ability to resolve colours and keep a steady screen. Each band should be distinguishable.

Test H A monitor should be able to display text/graphics instantly and remove them instantly. No image should remain on the screen after the text is removed.

Test I The colour test is included to enable a comparison of the clarity, richness and depth of the colours (or shades).

How each review monitor coped with these tests can be seen in the test summary chart on page 136.

My first impression of the Novex colour monitor was of a tall and 'boxy' appearance, but the metal casing is strong and well styled. As with all the monitors reviewed here its colour matches the BBC system very well. I particularly liked the strong carrier handles on each side – ideal for school use where monitors may have to be carried up and down stairs. Its height means that in use it can be positioned comfortably behind the BBC micro, as the bottom edge of the display is at least 100mm (4in) above the working surface. The depth of working surface needed to accommodate both is a hefty 750mm (30in), however. As it's a standard resolution monitor the manufacturers have been able to include useful additional facilities.

The Novex 14-inch is designed to work with micros with either separate RGB and synchronising signals at TTL level or a composite video signal. Both inputs are on the rear of the cabinet, the former an eight-pin DIN socket and the latter a phono connector.

The video input allows you to share the Novex with the home video recorder – a real bonus. The full tone colour pictures from a video recorder were very satisfactory. An audio input is supplied, designed specifically for amplifying the sound channels of micros. Its sound

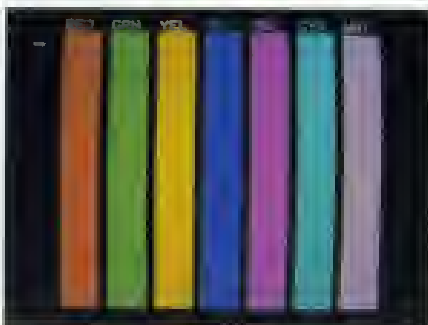

In this test of colour resolution each colour band should be distinguishable



The spaces separating the horizontal white bands should be evenly black

quality is quite adequate for this purpose.

The controls are all sensibly at the front of the monitor. The on/off button (volume control) is surface-mounted, but all other controls are in a covered panel below the screen, easily accessible yet well protected.

Perhaps the most novel feature of the Novex monitor is its facility to switch off the red and blue guns, thus allowing the screen to display green text only. Whether this is useful is debatable. It works perfectly well with 40-column text but is not suitable for 80-column work because the slot-mask becomes more apparent when only one gun is functioning. It is not clear whether the overall colour balance would be affected after prolonged use of the green display.

The picture geometry is good without any noticeable distortion. Picture brightness and contrast are good and colours reproduced satisfactorily. The overall resolution is acceptable but would not be suitable for long-term viewing of 80-column text.

With its bonus feature of video and sound input and a satisfactory overall performance the Novex 1414 is good value for money and can be recommended.

The difference in size between the Kaga Vision 3 and the Novex couldn't be more striking. The Kaga is a compact little monitor and this is due entirely to the fact that this is a 12-inch monitor. Although it is available in three models (medium, high and super-high resolution), I chose the last to review as this is described as 'a perfect match for the BBC micro's graphic capabilities'.

It's a good-looking monitor with matching plastic cabinet and sloping screen. The angled screen is an advantage when using the monitor on a plinth. The cabinet seems a bit thin and I wonder how the monitor would stand up to the rigours of an educational environment. The most serious oversight is the lack of a carrying handle. The screen is mounted in a light-brown, non-reflective surround which has four clips to accommodate a detachable, anti-glare hood. I should hardly think a Kaga owner would need one, however,

because the monitor has a non-glare screen.

One of the features that sets it apart from others is its 'matt black' tube. Its colour reproduction must be seen to be believed. It performs equally well in bright lighting as it does in a shady corner. The non-reflecting screen is a boon to writers using it for word processing; unwanted reflections are kept at bay with no apparent loss of character definition.

Only two controls are visible – on/off switch and brightness control. A whole range of picture adjustments are available at the rear. Kaga includes an adjusting tool and a comprehensive manual to enable the user to get the best out of the display. I was pleased from the teacher's point of view to see that these controls are snugly recessed out of the reach of little fingers. The same is also true of the ventilation grill at the top rear of the cabinet.

'If you can afford it and you want to get the best out of your Beeb the Kaga Vision 3 is in a class of its own'

As it is not possible to include a PAL/video facility on high-resolution monitors like the Vision 3, Kaga has opted to include this and an audio output facility in its Vision 1 standard-resolution model. Vision 3 has an interface which allows both linear and TTL inputs. Two sockets are provided: an eight-pin linear RGB connector and an eight-pin DIN for the two possible TTL inputs. A three-way selector switch on the rear panel thus ensures that the Kaga can be used by any computer with a true RGB output – most useful if you want to use the monitor with a variety of computers.

As a colour monitor Vision 3 excels. The reproduction of mode 0 graphics is excellent. The results from the test program speak for themselves. What impressed me was the fact that I was able to use the monitor to write this review in 80

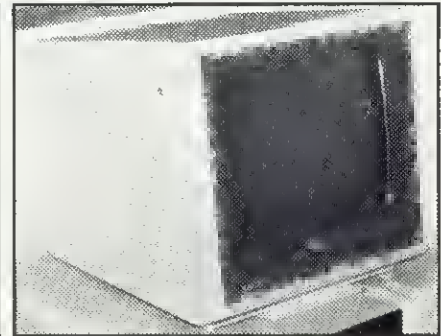

The Kaga Vision 3 monitor's colour reproduction 'must be seen to be believed'

columns with the View word processor. All characters are clearly reproduced and using it for hours on end caused no discomfort. The clarity almost matches that of a monochrome monitor. My only criticism concerns the geometry of the display. The top portion tends to splay out slightly, distorting any rectangles or squares that happen to be in that region. Despite this small niggle I find now that I compare all the monitors I see with the Kaga Vision 3.

Not everyone can afford the outlay for even a standard-resolution colour monitor. For those who would be content with a simple, affordable alternative to the family TV the answer may be a monochrome monitor. Prices for these sets usually hover between £70 and £120 and there's plenty of choice. The two reviewed below are just a sample of what is available.

The Sanyo DM8112CX data display monitor is not to be confused with a similar product marketed by Sanyo of Taiwan. The Sanyo under review is made in Japan and is distinctly recognisable by its non-glare panel.

This monitor is cased in a plastic cabinet and like the Kaga has no carrying handle, but this is not such an inconvenience as monochrome monitors are generally much lighter than their colour counterparts. The colour matches the BBC micro's case accurately and the overall effect is pleasing. The design of the cabinet makes it particularly suited to being stood on a plinth above the micro. Video input is via a phono socket mounted on the back panel. On the front are just two controls: the on/off switch and brightness control. There's contrast control at the rear. I found this to be inconvenient – I would have preferred them both to be at the front.

The Sanyo has a green phosphor tube and all colours are reproduced in shades of green. The display is rather small and cannot be adjusted. However, the picture geometry is very good. High-resolution graphics are accurately reproduced and mode 0 proved no problem at all. For a green screen monitor the degree of persistence (afterglow) is very good indeed. My only criticism concerns the anti-

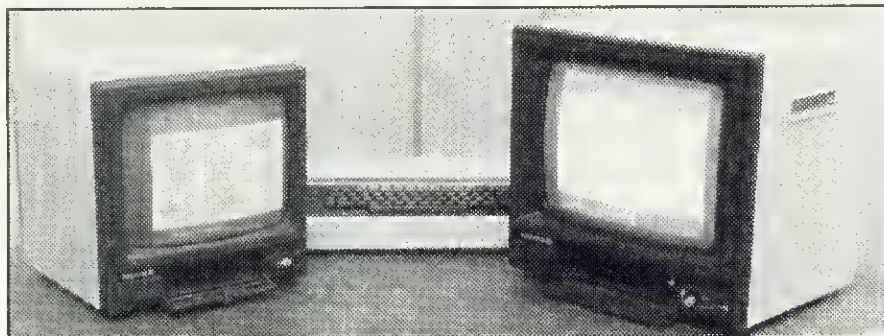

The robust Novex colour monitor (right) is ideal for school use. The Novex green screen monitor (left) has many of its larger relative's good features

glare panel on the front. It may stop glare from the tube but it picks up numerous reflections from a bright room. The reproduction of 80-column text is excellent, making this monitor a good choice for business users.

The Novex 12/500MG green screen monitor may be familiar to some readers in its other guise: the BBC (official) monitor. Looking very much like a smaller version of the Novex 1414, it has many of the good features of its larger relative. The design enables the monitor to be positioned either on a plinth or on the working surface behind the computer.

It is cased in a strong metal cabinet with a single carrying handle on the top, set flush. As in the 1414 model, the colours match the BBC system perfectly. The screen has a good non-glare matt finish and is easy to use even when light is shining on it directly from a window.

Two phono sockets are provided on the back for video in/out. The video out facility enables bridging of monitors, which must be useful in some applications. A 40/80 column switch is also to be found at the rear, enabling the user to select a semi-permanent setting of screen mode width. I liked the illuminated on/off rocker switch on the front—a good touch, this. Other user controls are accessed via a small recessed panel, and a superb range of adjustments are available, a design I found most convenient.

The Novex displays text clearly in 80 columns, ideal for use with any monochrome word processor package (View, BeebPen etc). The geometry is excellent and screen borders perfectly straight. High resolution mode 0 graphics are accurately reproduced. My main criticism of the Novex 12/500MG is the degree to which it suffers from persistence. Even so, it's not as bad as some green screen monitors on the market and many users will find it quite acceptable. If this is a vital factor then choose the amber screen version (12/500A), which displays no afterglow at all.

Overall the Novex 12/500MG is a delightful little monitor to use. Its all-round performance is ideal for most applications. This, coupled with its reasonable retail price, prompts me to recommend it highly.

Which one should you buy? There are too many factors involved to give specific answers. If a budget-priced general-purpose colour monitor is required then the Novex 1414 should be high on your list. If you are a business user or writer either of the two monochrome monitors mentioned will do the job. If you can afford it and really want to get the best out of your Beeb the Kaga Vision 3 is in a class of its own.

My thanks to Retail Control Systems and Technomatic for technical assistance in helping to prepare this review. **CD**

DATASHEET

Product: Novex 14in colour monitor (NC-1414-CL-UK)
Manufacturer: Novex Electronics, Hong Kong
Purpose: Standard RGB/PAL video monitor
Dimensions: 385 × 370 × 355mm (W × D × H)
Weight: 14.7kg
Resolution: 452 × 585 lines
Band width: 7MHz
User Controls: PAL: colour, contrast and brightness. RGB: V-hold, brightness. Picture selection switch, power on/off
Price: £199.95 + VAT + carriage
Review copy from: Retail Control Systems, Enterprise House, Central Way, North Feltham Trading Estate, Feltham, Middlesex.

Product: Novex 12/500MG green phosphor 12in monitor
Manufacturer: Novex Electronics, Taiwan
Purpose: High-resolution monochrome monitor
Dimensions: 300 × 300 × 275mm
Weight: 8.4kg
Resolution: 1000 × 800 lines
Band width: 20MHz
User Controls: Contrast, brightness, V-hold, H-hold, H-width, V-size, hi-low input level, graphic/text switch, power on/off
Price: £75.62 + VAT or £86.12 + VAT (non-glare screen)
Review copy from: Retail Control Systems, Enterprise House, Central Way, North Feltham Trading Estate, Feltham, Middlesex

Product: Kaga Vision 3 12in colour monitor
Manufacturer: Kaga Electronics, Japan
Purpose: High-resolution RGB anti-glare monitor
Dimensions: 320 × 393 × 303mm
Weight: 12.5kg
Resolution: 640 × 512 lines
Band width: More than 18MHz
User Controls: Brightness, V-hold, H-hold, V-size, H-size, V-position, H-position, power on/off
Price: £370 + VAT
Review copy from: Technomatic, 15 Burnley Road, London NW10 1ED.

Product: Sanyo 12in green screen monitor DM8112CX
Manufacturer: Sanyo Marubeni, Japan
Purpose: High-performance data display monitor
Dimensions: 320 × 324 × 272mm
Weight: 8kg
Resolution: 850 × 750 lines
Band width: More than 18MHz
User Controls: Contrast, brightness, V-hold, H-hold, V-linearity, height, power on/off
Price: £99 + VAT
Review copy from: Technomatic, 15 Burnley Road, London NW10 1ED.

OVERALL PERFORMANCE

MONITOR TEST	NOVEX 1414	KAGA VISION 3	SANYO DM8112CX	NOVEX 12/500MG
A	**	*****	*****	*****
B	**	*****	*****	*****
C	***	****	**	****
D	***	*****	*****	*****
E	****	**	*****	****
F	*****	****	*****	*****
G	**	*****	**	****
H	****	*****	**	**
I	****	*****	**	****
		KEY		
		EXCELLENT	*****	
		GOOD	****	
		SATISFACTORY	**	
		POOR	**	
		VERY BAD	*	

ARIES-B20

Add 20K to your BBC micro in five minutes

Features

- ★ Adds 20K of useable RAM to your BBC Micro
- ★ Run programs up to 28K long in ANY SCREEN MODE
- ★ Extra memory can be used directly from BASIC I and II, VIEW 1.4, FORTH, LISP, and many other existing programs
- ★ ARIES-B20 is compatible with all correctly written BBC Micro software, on cassette, disc, sideways ROM or cartridge
- ★ Don't be deceived: this product is unique - no other expansion unit has these capabilities
- ★ Complete compatibility - ARIES-B20 uses only documented MOS facilities
- ★ Fitted in 5 minutes using only a screwdriver
- ★ Simply plugs in inside the case
- ★ No soldering or cutting
- ★ (Unlike some add-on products) will cause no damage to your

- BBC Micro - can be removed at any time
- ★ Incredibly simple to use
- ★ Patent applied for
- ★ Designed in Cambridge by BBC Micro experts
- ★ Top quality manufacture
- ★ Unquestionably the most important add-on ever produced for the BBC Micro
- ★ Top software houses are racing to produce the "super-programs" made possible by the extra capacity
- ★ 1 year guarantee.
- ★ Available mail-order only
- ★ Official purchase orders accepted from bona-fide educational establishments, all other trade cash-with-order

- ★ Price £99.95 including post, packing and VAT
- ★ If not completely satisfied with your purchase, we will refund your money in full providing you return the ARIES-B20 in good condition in its original packaging within 14 days

Machine requirements:

- ★ BBC Micro model B
- ★ MOS 1.2 or later
- ★ Plugs into CPU socket and 1 sideways ROM socket

Also available IEEE-488 interface.
Coming soon: Compatible ROM expansion board.

How to Order:

Send cheque or postal order made payable to: Cambridge Computer Consultants Ltd and forward to:
Cambridge Computer Consultants Ltd, Science Park, Milton Road Cambridge CB4 4BH Telephone: Cambridge 0223 862614

Please send me (Qty) ARIES-B20(s) at £99.95 (incl. p.p. & VAT).
I enclose a cheque/postal order made payable to

Cambridge Computer Consultants Ltd for £.

Signed

Name (block letters)

Address

. Post Code

Cambridge Computer Consultants Ltd, Science Park, Milton Road Cambridge CB4 4BH
Telephone Cambridge 0223 862614

Draw with the BBC micro and show the true potential of your machine

Fill shapes in one of 23 colours (Mode I)
 Draw points, lines, rectangles ellipses and circles
 Smooth curves
 Wire frame diagrams
 Hidden line removal
 Draw in perspective
 Measure scaled distances
 Ekta sketch lines, Half tone facility
 Mirror images
 Repeat images, SS, enlarged, reduced, stretched
 Actual colour displayed
 Store up to 10 ellipses or circles in memory
 Redraw any one of these at cursor position
 Change any actual colour for one of 8 others
 Clear screen, load screen, save screen
 Print characters or numbers at any pixel point
 Error messages for incorrect input
 Fully comprehensive manual

35£ 496 • □ ••• 3

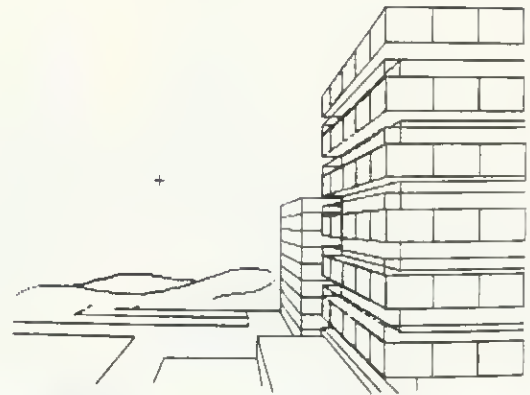

This programme has been purpose designed by professional Graphic Designers for simplicity and ease of use, and is undoubtedly the most versatile drawing programme on the market at this time. There is no need to input any numerical data, as all judgements are made visually. The BBC Micro is the finest drawing machine in its price range. Find out what it can do.

The A.B. Designs drawing programme costs only £35 for over 70 functions (Model B). New AB2 Program, available on disc (price £60.50) and cassette (price £50.50). When ordering send Cheque/PO and include 50p for P&P. Please include phone no. with all correspondence. For further information send SAE and phone no. to A.B. Designs, 81 Sutton Common Road, Sutton, Surrey. 01-644 6643 (closed all day Thursday).

Diary & RAM Filing System for the BBC Microcomputer

"The RTC+RAM provides a fast and efficient Diary and RAM filing system that is particularly simple to use."

Acorn User, April 1984.

The Diary is sophisticated, yet simple to use appointments' storage and retrieval system with unique features:

- Available and accessible at any time - no need to load disc or tape.
- Audible alarms at preset times with associated screen messages.
- Automatic reinsertion of repeating reminders.
- Search of appointments by particular words or numbers.
- Easy entry and display of messages.
- Easy access to real time and date from other programs.

RAM filing system provides convenient storage for most frequently used programs and documents.

RTC+RAM system comprises Diary and RFS software in a ROM, electronics in a separate housing (4Kbyte or 30Kbyte storage) and instruction manual.

4Kbyte RTC+RAM £128.00p+ VAT + p/p (£149.00p inc.)
 30Kbyte RTC+RAM £300.00p inc. (4Kbyte to 30Kbyte upgrade is available)

Further information from Acacia Computers Limited,
 7 Supanee Court, French's Road, Cambridge CB4 3LB.
 Tel. 0223 312124



THE BBC MICRO SOUND SYSTEM MICROVOC

As supplied to Schools & Colleges

SYSTEM INCLUDES:

Speakers, Volume control, jack sockets and all connections (assembled) plus Buzzgo to eliminate the infernal B.B.C. buzz.

Easily fitted with no drilling, soldering or cabinet modifications £23.00 inc VAT and p & p

MICROVOC WITHOUT SPEAKERS
£15 inclusive

Now in stock - The Synth. This program allows the mixing and saving of all four channels, including Channel 0 for cymbals and drums. Complex melodies can now be entered in minutes by even a complete novice.

**MICROVOC IS IDEAL FOR SPEECH
SYNTHESIS OR COMPUTER PRODUCED
MUSIC**

MICRO-ADVENT

Ashlyn House, 113 Writtle Road, Chelmsford, Essex.
 Tel: 0245 59708

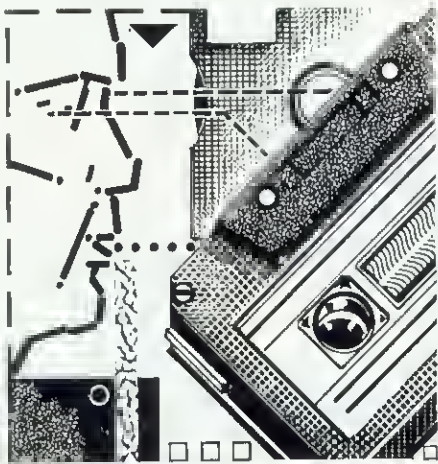

MANY A SLIP

'TWTX MOON AND

MOTHER SHIP

'Lunar Rescue', Alligata Software, BBC B and Electron £7.95

I WONDERED at first whether I had the right game – the cassette cover said *Lunar Rescue*, but all references within the game were to *Space Rescue*.

Whatever its name, the game at first appears like many others in concept, but as you play it you begin to appreciate the differences that add to its appeal.

You start off in the mother ship at the top of the screen, and the object is to rescue six men stranded on the planet below. You release from the mother ship, manoeuvre your way down and try to land on one of three pads. Sounds easy until you realise there are four rows of asteroids moving across the screen in different



directions, and you must avoid them at all cost.

If you land on a pad without crashing into it or any of the asteroids you get bonus points according to the rating of the pad. That level on the pad is then removed, so it becomes smaller and more difficult to land on at your next attempt – and the bonus points higher. Once you're down one of the men runs across the screen and into your ship – a very pleasing effect. Your ship takes off automatically but to your horror the asteroids change into rows of alien ships which immediately start dropping nasty things on you. You can fire back at them but you have to concentrate on dodging them to reach the mother ship.

Your troubles are not over if you do get through. When you break through, the mother ship stops and opens its door and you have to manoeuvre inside. If you haven't reached a suitable position you will crash into the ship and lose a life or hit the top of the screen, at which point your little man plummets to the surface, never to be seen again.

You repeat the process for each of the six men and are rewarded with bonus points if you rescue them all. If you reach 3000 points you get an extra rescue ship. You continue until you run out of fuel or you lose your three lives, which isn't difficult.

Your controls are Z and X for left and right, and a nice additional feature is the multi-use of the return key. It releases you from the mother ship and also slows down your descent (which unfortunately uses up fuel). You use it to fire at the aliens as you go up, and your ascent speeds up if you keep your finger on the button. A pity that a game as good as this doesn't provide for joysticks.

Resolution and speed of graphics is good and the sounds are appropriate. The game requires great concentration and dexterity. It is good value for money and if you like action sufficiently different to make it worth buying.

Ian Rowlings

PUSHING AND

SHOVELLING

'JCB Digger', Acornsoft, BBC B, £9.95 (disc £11.50)

ANY game that promises a mixture of *Monsters* and *Snapper*, with the originality of driving a JCB earth-moving digger around an island, and written by Acornsoft, sounds like a real winner.

The screen display of *JCB Digger* is a window on part of the island's landscape and the JCB is in view at all times. The vehicle can be moved in the standard four directions – up/down, left/right. Viewed from the side, the JCB has two main moving parts, a shovel/hopper at the front that fills in holes and clears earth and other obstructions, and a mechanical digger arm at the rear. These movements can be controlled by two further keys or by joystick.

The aim of the game is to drive the JCB around the landscape, clearing it of various obstructions such as earth and trees (not a game for conservationists). There's one little problem, however. The meanies! These are circular floating monsters who, if they catch up with you, will push you out of the driving cab and drive the digger away. So, your task is to clear the landscape and kill the meanies. They can be killed by digging holes (though you are limited by the number

you can dig) and hoping a monster falls in and then filling in the hole (surely this idea has been used before?). Or you can catch a monster on the front of the digger when the shovel is down and push it into the sea and drown it. You have three lives and with succeeding screens the monsters change colour and the difficulty level increases.

JCB Digger is supplied on cassette or disc and there are the usual options of a pause facility and turning the sound off –



something you'll probably want to do quite quickly as the sound effects, though well-executed, become annoying especially as clearing a screen takes a long time.

I found *JCB* disappointing for a number of reasons. First and foremost, the 'shudder' on the screen is irritating. Hardware screen scrolling is used in all directions, as there is a lot of landscape to get round, and when you move vertically the top and bottom lines of the screen flash and jump. If a monster catches you, the driver jumps out and the monster drives the digger off-screen. The problem is, an after-image of the driver stays in the cab.

The idea behind *JCB* is novel, but in the final analysis lacks the punch of previous offerings from Acornsoft. The idea is not done justice by the screen display. Too much has been sacrificed to achieve a landscape scroll in all directions and the final product is not of the quality we have come to expect from Acornsoft and Jonathan Griffiths, who also wrote *Snapper*.

JCB held little interest for me, though there might be some who will like it purely for its new approach to chase-the-monster and eat-the-dots. **Dee Vince**

GHOULS AND

JEWELS

'Ghouls', Micro Power, BBC B, £7.95

GHOULS is a delightful game set in a mansion on top of a creepy hill. There are said to be 'power jewels' inside, but all those who have gone in search of them have fallen victim to the mansion's deadly inhabitants.

The mansion has four sections. First you must traverse Spectre's lair, on through Horrid Hall, into the Spider's

For the BBC Micro

ROMS



ORIGINAL SCREEN DISPLAY

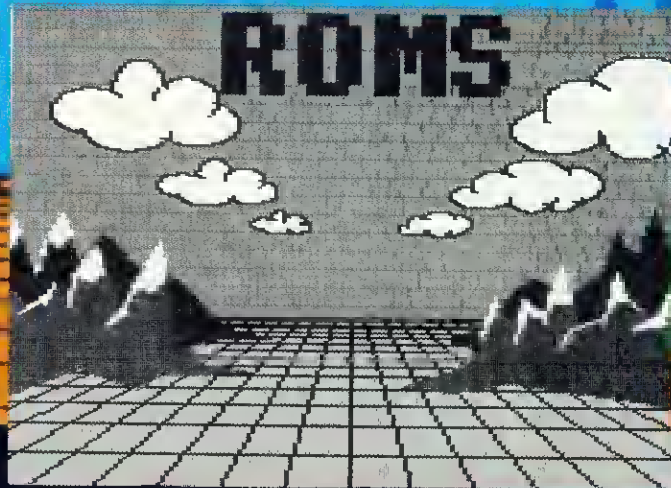

WHOLE SCREEN DUMP

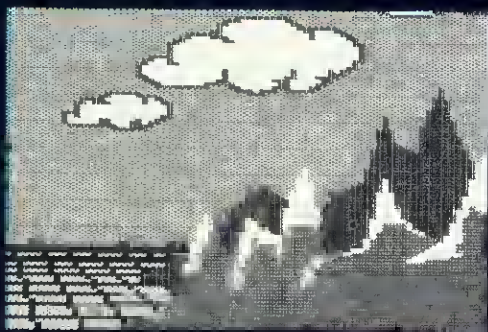

ENLARGED PART OF SCREEN

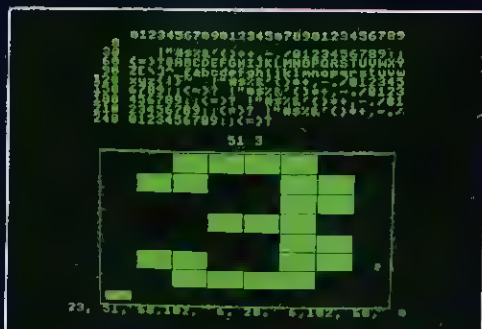

*DEFINE IN ACTION

Printmaster

Joining our already extensive range comes PRINTMASTER a sophisticated printer handling utility ROM. PRINTMASTER will be released in several versions catering for each of the most popular printers on the market. This first PRINTMASTER ROM supports a range of EPSON printers: MX80, RX80, FX80 and other compatible printers.

All commands in the ROM must be preceded by an asterisk and can be used like all normal operating system commands from within BASIC programs etc. It is also possible to use them from WORDWISE and other language ROMs.

PRINTMASTER supports three types of screen dumps. The most flexible (*GDUMP) allows any graphics on the screen to be dumped onto the printer. This will operate in any mode, the colours being displayed as shades. Any part of the screen may be printed at any position on the paper in any one of four orientations. It is also possible to magnify the screen dump by any factor x2, x3, x4 etc.

A special feature allows true Mode 7 screen dumps with TELETEXT text and graphics, colours (as shades), double height etc.

*TDUMP allows any text mode to be dumped and *FDUMP will automatically print the contents of a file on disc to the printer WHILE the BBC machine is doing other things, running other programs etc.

*DEFINE allows the redefinition of any user definable character in the simplest possible manner. See screen photo opposite. *USAVE and *ULOAD can be used to save or load all user definable characters.

*WINDOW allows the user to interactively define a graphics window, this controls the part of the screen printed in *GDUMP this is a very much easier method of defining graphics windows than the normal VDU statement.

The above list is only a fraction of the commands in the PRINTMASTER ROM. Others include *CENTRE, *UNDERLINE, *ITALIC, *MARGIN etc. etc. which provide total control over the printer. Order as PRINTMASTER (Epson).

£33.35 incl. VAT and p&p.

COMING SOON!
ACCELERATOR
BASIC Compiler

COMPUTER
CONCEPTS

16 Wayside, Chipperfield, Hertfordshire WD4 9JJ. Telephone Kings Langley (09277) 69727

available
now

parlour and finally to Death Tower. Each one must be finished before your time runs out.

Each section has defences, however – poison-tipped spikes that you must jump over and a ghost that follows you. The spider, which guards her parlour, bounces up and down and you have to dodge beneath her. Worse still are the moving platforms and disappearing floorboards. On some levels, you use powerful springs to bounce from floor to floor. You are not without defences, though. If you can eat a stray power jewel, the ghosts will disappear for about 15 seconds.

The graphic quality of *Ghouls* is impressive, despite being fairly straightforward. I liked the sideways scrolling after each level (as described in April's *Acorn User*) and the way the screens are displayed, but some of the movement is jerky. The funniest aspect of the game is the way your character moves, complete with the pitter-patter of tiny feet, though I was concentrating more on that spider.

Sound can make or break a game, and the sound in *Ghouls* is superb. Some of the noises are creepy, and would be well-placed in a horror film! You can even have music playing while the tape loads.

The program includes a top-ten scores table, and you can pause while you brew your tea. Controlling your men (you start with four) is simple, using Z, X to move and 'Return' to jump. The game itself is not so easy!



Ghouls is a great game with superb sound, fair graphics and enough problems to keep the player trying.

Stuart Menges

DOTS & CRASHES

'Dodg'em', Microgame Simulations, BBC B, £00 (disc £00)

MY FIRST reaction to Dodg'em was 'I've seen this somewhere before!' Sure

enough, it is a faithful reproduction of an arcade game popular a couple of years ago.

It's simple in concept if not easy to win. The aim is to move your car around a four-lane track covering as many red dots as possible and jumping from lane to lane to do so. The computer car is also swapping lanes and trying to crash into you. Fortunately, when you jump you cover two lanes whereas the computer car jumps only one. You can also accelerate out of danger – or into it.

You have three lives before the final collision, and your score reflects the number of dots covered. Remove all the dots on one screen and you progress to the next. There are 15 screens, all presumably of the same format, except that as you progress you are confronted by up to three computer cars at once.

The game is compulsive for the masochistic, but the choice of keys seems a little strange – A/Z for up and down and K/L for left and right – still, I expect you get used to it.

The animation is not very fast but then if it were you'd never get past the first screen. Altogether, it's quite a nice game of its type.

Ian Rowlings

**A Full One Year Warranty offered on all the products we sell.
Full Pre/Post Sales Support.**

PRINTERLAND



EPSON RX80

- 100 CPS 9 x 9 matrix
- True descenders
- Bit image graphics
- 11 character sets
- 3 character styles
- 6 printing sizes
- Very reliable

RX80T £219.95
RX80F/T £239.95

• FREE Screen dump (Cassette)

STAR GEMINI 10X

- 120 CPS 9 x 9 matrix
- User defined characters
- Friction/Tractor and roll holder
- Macro Instructions
- 3 character styles
- 6 printing sizes
- Value for money

10X £218.95
15X £315.00

• FREE Hi-Res. Cassette

COPY ALL DISK

- Copies ALL protected disks inc. tape to disk utilities
- So good it even copies itself
- Simple to use
- Includes sector editor
- Reads individual sectors
- Re-writes sectors
- Verify & mend

COPY ALL £10.50

WORDWISE

"The" Word Processor £32.00

Printer Cable £10.99

BASF SS S/D Disks (Box 10) £13.95

Paper (2,000 shts.) £12.00
+ £3.00 carriage

EPSON FX80

- 160 CPS 9 x 9 matrix
- Proportional spacing
- Downloadable characters
- 3K Ram buffer
- Extra forms handling
- User defined margins
- 3 character styles
- 6 printing sizes

FX80 £329.95
FX100 £434.00

• FREE Hi-Res. Cassette

DAISY WHEEL PRINTERS

BROTHER HR15

- 18 CPS • 3K buffer
- Proportional spacing
- 2 colour print

HR15 £369.00

DAISY STEP 2000

- 20 CPS • 10, 12, 15, CPI
- Proportional spacing
- Japanese reliability

DS2000 £267.00

MONITORS FIDELITY CM14"

- RGB • RGBY
- Composite video
- Works with all micros & VCR's

CM14 £169.95

PHILIPS 12" Green Screen

- 80 column & graphics
- Fully BBC compatible

TP200 £74.95

ORDERING INFORMATION

- Orders received before 3pm – despatched same day
- Government, Educational orders welcome
- Credit Cards – just ring your order through

CARRIAGE printers/monitors (24 hour delivery) £7.00

Other – 50p (1st Post)

Please add 15% VAT

UNIT 27, ESTATE BUILDINGS, 2 RAILWAY STREET, HUDDERSFIELD HD1 1JP TEL. HUDDERSFIELD (0484) 514105

- The complete AMS disc drive package, tailored to your BBC micro, is compatible with all disc interfaces and includes cables, a comprehensive manual and utilities on either disc or EPROM. Housed in a steel case, matching the BBC micro, these reliable and robust Hitachi 3" disc drives are the ultimate for home, office and classroom.
- The 3" disc is totally enclosed in rigid plastic and a unique automatic steel shutter protects the delicate disc surface from dust and finger marks. For the first time discs can be used in industrial, educational and commercial environments without the worry of corrupting precious programs and data.
- The disc is "flippable" like a cassette tape and has a storage capacity of 100K on each side in single density mode (twice as much when used with a double density interface). A neat plastic switch can be flicked back and forth to write-protect valuable discs.

- The AMS disc drives are completely hardware and software compatible with 5 1/4" drives which can be used in parallel so allowing easy transfer of software. Consequently the 3" drives will operate with all the standard floppy disc interfaces. They take their power from the outlet provided by the BBC micro - there's no onboard power supply to corrupt data.
- The AMS package includes utilities on either disc or EPROM for formatting and verifying discs. The EPROM, which is easily fitted, offers a simple to use and permanent alternative to using the utilities disc.
- The impressively engineered Hitachi 3" drives feature an eject button allowing single handed operation, a multi-colour LED indicating the disc side in use, and a brushless direct-drive motor for reliable operation. The super fast track-to-track access time of 3ms is at the forefront of disc drive technology. The longest of programs are loaded in a flash.

Advance with AMS

3" Disc Drives - The Ultimate Choice

Recommended Retail Price
Single 200K - £199
 (100K per side)
Double 400K - £385
 (200K per disc)
 includes VAT and delivery

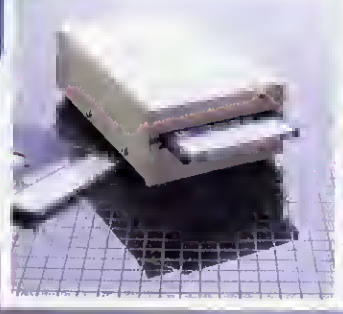

Direct Delivery

If not available from one of our 200+ dealers fill in the coupon and we will deliver your order promptly.

Advanced Memory Systems Ltd, Green Lane, Appleton, Warrington WA4 5NG
 RING 0925 62507 OR 62682

TO: Advanced Memory Systems, Ltd, Woodside Technology Centre, Green Lane, Appleton, Warrington Cheshire WA4 5NG

Please send me:

- Qty _____ AMS-3 (S) single disc drive all inclusive package at £199 each
 - Qty _____ AMS-3 (T) twin disc drives all inclusive package at £385 each
- Prices include utility disc, cables, manual, VAT and delivery
- Please send me by post, if not with drives.
- Qty _____ double sided (100K x 2) discs at £4.95 each
 - Qty _____ packs of five at £22.50 per pack
 - Qty _____ Formatting and Verification Utility EPROM £17.25

I enclose a cheque for £. or debit my credit card

No. _____

Name _____

Address _____

Post Code _____

Signature _____



Tel No _____

Date _____

 **Hitachi - in a word reliability**

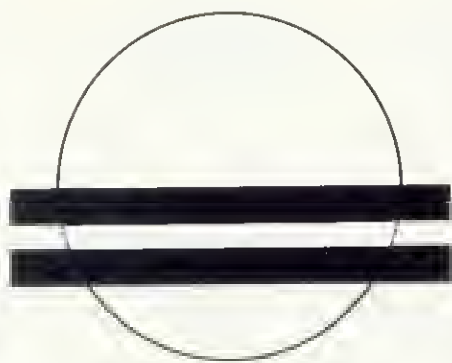

DOTTY APPROACH TO DAISYWHEEL

George Hill on the Canon PW1080A
NQL and Sanple Daisy Step 2000

WHAT you may ask is an NQL printer? Here is another piece of jargon being foisted on the computer public!

NQL stands for Near Letter Quality.

How near is near? Well I reckon it is very near. The Canon PW1080A has very fine dot wires, and produces a somewhat 'dotty' style of print in normal print mode, but the gaps between dots are filled in in NQL mode, producing a typeface almost indistinguishable from daisywheel print except under a magnifying glass. Only the descenders (tails of the p, g, y etc) betray it. They are limited to two dots' depth but the style is attractive and a considerable improvement on anything I have seen before at the price (£319 + VAT).



At £258.75 the Sanple Daisy Step 2000 may be the cheapest daisywheel available (review model supplied by Kyeaki Ltd)

For me, the beauty of this printer is that its printing control characters and escape sequences are, praise be, identical to the Epson FX80 set, and hence all programs written for the MX or FX80 work perfectly on the Canon. I will not bore you with a repeat of the FX80 review, printed in the October 1983 issue. The more important features shared by the Canon are:

- Full graphics capability, including single, double and quadruple density graphics, CRT graphics (640 dots per line – enough for two dots per pixel in mode 1), 'plotter graphics' (precisely round circles for design work) and nine-pin graphics.
- Extensive 'download character' capability, with full freedom to switch character sets.
- Variety of print styles, including italics, pica and elite, and proportional spacing.

- High speed – 160 characters per second.

How does the Canon differ from the Epson (and its Star competitors)? Let's look at its design features and printing capability.

First, it's smaller and neater than the Epson, and infinitely more convenient to load with paper. The paper feed mechanism has the 'tractor' (the wheels with pins which locate in the fanfold paper to drive it) mounted *before* the roller (figure 1). This mechanism is the same as the Shinwa C80 printer, on sale in WHSmith's. The arrangement allows reverse paper feed without the danger of jamming the paper in totally inaccessible places, a continuous source of annoyance with the

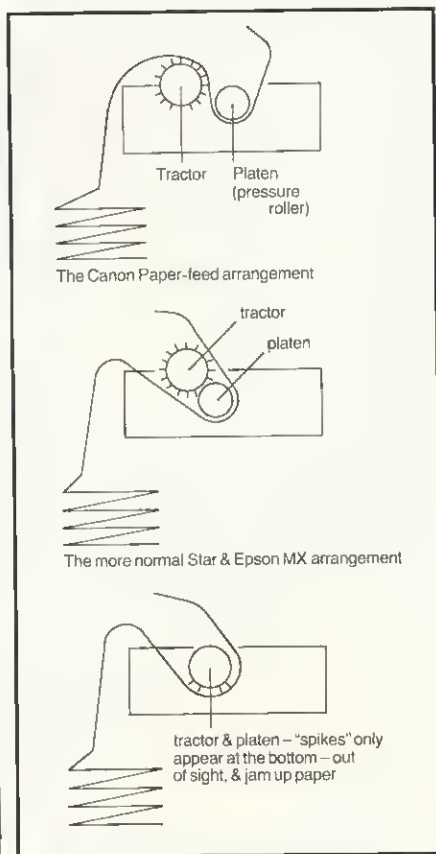

Figure 1. Tractor feed arrangements

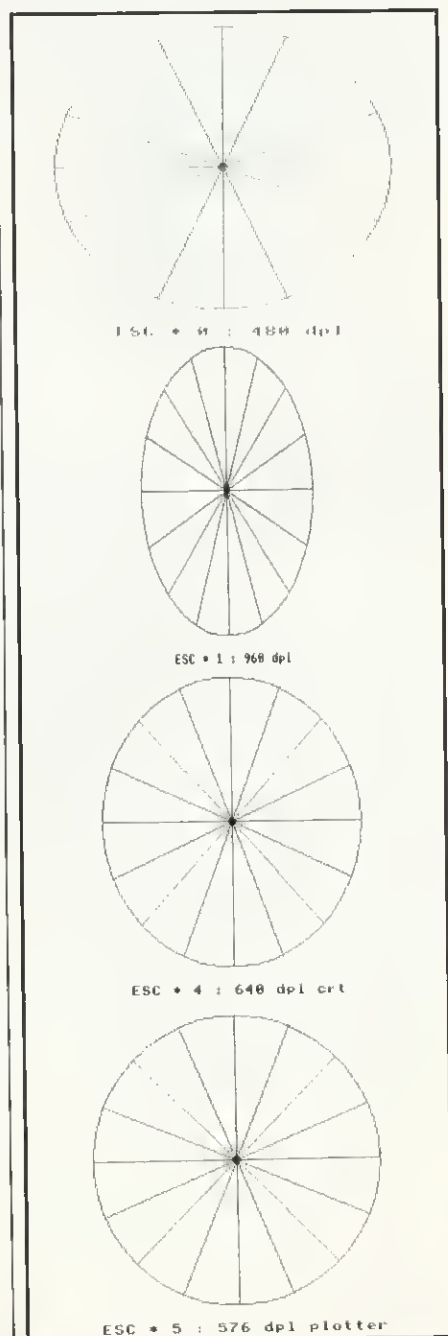

Figure 2. How round is a circle? Here are some ESC * graphics options

CROYDON COMPUTER CENTRE

OFFICIAL ACORN SERVICE CENTRE

29 Brigstock Road, Thornton Heath, Surrey.



01-689 1280



MODEL A £299.00
MODEL B £399.00
ACORN ELECTRON £199.00

+ Full range of spares always in stock.



TORCH
Z80 DISK PACK £830.00

Includes £1,000 free software.

MICROVITEK COLOUR MONITOR £244.00
ZENITH 12" GREEN OR AMBER £99.00
CUMANA SLIMLINE DRIVES from £216.00
EPSON RX80 £333.00
JUKI DAISYWHEEL £458.85

Full range of books, software, paper and spares for every popular micro and printer. Our four years in the micro business and investment in trained engineers and test equipment is your guarantee of peace of mind.

EXPORT ENQUIRIES WELCOME
Happy customers in twelve countries

ALL PRICES
INCLUDE VAT

01-689 1280

FOR SPARES AND REPAIRS

SPEECH RECOGNITION

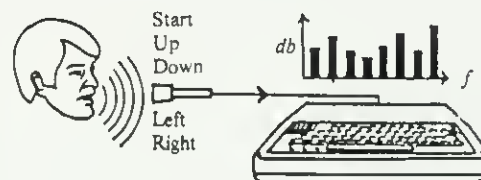

Speak to your BBC, with the U-PHONE SPEECH RECOGNITION AND SOUND ANALYSER system.

- * Real time interactive system, runs in background, as if part of the operating system.
- * Recognises speech as if typed from the keyboard. Thus most keyboard interactive software may be adapted to accept speech input.
- * Multi-level vocabulary allows words to be placed in their context. Thus sentences may be constructed and recognised.
- * Learn mode builds vocabulary and displays dictionary.

Applications include voice operated control systems, keyboard/joystick/light-pen supplement, voice operated games, disco sound-to-light, deaf persons speaking aid, general linguistic aid, etc.

Price of system, £44.50 (+ VAT). Send for further details and an order form to:—

RPG MICROSYSTEMS
P.O. Box 39, Newbury, Berkshire RG14 7HU
Educational/Trade enquiries welcome.

SLOGGER SOFTWARE

MACHINE CODE GAMES FOR BBC 'B', ELECTRON, SPECTRUM

A MAZE IN SPACE

Use Joysticks or Keyboard to navigate your Starship to the planet surface and then into the maze below. Having been told in which section of the maze your target is hidden, your objective is to seek out and destroy it to complete a mission. Beware of the numerous alien defence systems. Two levels of difficulty! Horizontal and diagonal scrolling!
How many missions can you complete?

	Cassette	Disc
BBC 'B'	£9.95	£11.95

Special Offer

Dogfight and A Maze In Space together
Cassette - £14.95 Disc - £16.95

Please state 40 or B0
Track if disc

All prices include
VAT and postage

DOGFIGHT

Still undoubtedly the most exciting 2-player game available. The objective is to fire sufficient shots into your enemy aircraft to force it to explode. Eight levels of difficulty. Sun, moving cloud, lightning, ground all provide real combat environment.
Can you beat your friends?

	Available now	Cassette	Disc
BBC 'B'		£9.95	£11.95
Electron		£7.95	n/a
Spectrum		£5.50	n/a

SLOGGER SOFTWARE

215 BEACON ROAD
CHATHAM, KENT
Tel: (0634) B11634

FX80 at my college and in the *Acorn User* office.

Second, it has clear plastic at the critical point where you want to look at the paper. You can see the print-head without having to remove the cover or raise the lid. These two simple features make it very easy to use.

Third, it has a switch, located behind the tractor feed, which switches off the 'paper-end detector' if you want to change from fan-fold to cut-sheet paper. This saves sending complex escape sequences and resetting internal DIP switches.

Now the extra goodies in terms of printing capabilities. NLQ printing is produced by printing the patterns for a line of letters, then performing a 'half-dot' paper feed, returning the carriage, and printing a second pattern which neatly fills

inordinate number of reverse paper movements.

I detected a serious bug in the horizontal tab function. After sending ESC "D", followed by a list of the column numbers, terminated by 0, the tab-stops are set at the column positions specified by the parameters. If, however, the column numbers are 'printing characters' - eg, 50, 60, 70 in my program - they get printed. This accounts for the spurious appearance of 2 (CHR\$50), < (CHR\$60) and F (CHR\$70) in the tab line on the test routine.

The manual is a beautifully produced model of clarity. It is laid out along the same lines as the Epson FX80 manual. The only significant lack seems to be an alphabetical index.

The daisywheel competitor costs under £300, and is a full-size printer that, like the Juki, will take A4 paper sideways. It uses a

CANON
Prints
FABFACE

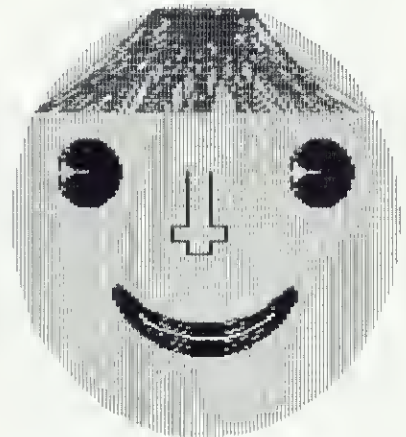

Figure 3. Face printed by 'Epatall' - the all-mode Epson dump

Qume-style ribbon cartridge and Qume-compatible wheels which are expensive but freely available.

The printing capabilities of the Sample Daisy Step 2000 are limited, but I doubt if most users would require the more advanced features. The most notable omission from the repertoire is proportional spacing. There's bold, shadow and underline printing for highlighting and the usual margin settings and tabbing arrangements.

Daisywheel printers seem unable to recognise paper widths, so you really have to set the margins every time you use the printer, by escape sequences (no DIP switch control), or use the WIDTH command from computer or word processor. At least, though, the margin setting is not at 'current carriage position' as in the Juki.

Close control of paper movement makes graphics printing possible, though the method differs from that suggested for the Juki. I suspect the dump routine (program 1) is more likely to prove generally applicable to daisywheels than

```
Normal character set.
!"#$%&'()*+,-./0123456789:;<=>?@ABCDEFGHIJKLMNPOQRSTUVWXYZ[\]^_`abcdefghijklmnopqrstuvwxyz{|}~

Italic character set.
!"#$%&'()*+,-./0123456789:;<=>?@ABCDEFGHIJKLMNPOQRSTUVWXYZ[\]^_`abcdefghijklmnopqrstuvwxyz{|}~

NLQ character set.
!"#$%&'()*+,-./0123456789:;<=>?@ABCDEFGHIJKLMNPOQRSTUVWXYZ[\]^_`abcdefghijklmnopqrstuvwxyz{|}~

This is in NLQ style,
and this is NLQ with proportional spacing.
This is NLQ enlarged with
and without proportional spacing.
Italics and standard in elite style
Italics and standard in proportional spacing

Now for the editors benefit the elloneohzero test.
I11-00o 111-00o

This illustrates the TAB function and its bug.
0123456789012345678901234567890123456789012345678901234567890123456789
(2<F~POS0 ^POS20 ^POS50

Any word or phrase may be underlined in any style
All types of print and graphics ##### CAR. be mixed on one line
Subscripts ,superscripts and download characters
2NaOH + H2SO4 -> Na2SO4 + 2H2O
N2 + 3H2 = 2NH3
(a + b)^2 = a^2 + 2ab + b^2
```

Figure 4. Example text printed on a Canon PW1080A printer

in the gaps. Printing by this method is, of course, much slower than normal - the 160 cps is reduced to 27 cps, pretty slow but still much faster than competitively priced daisywheels.

There is a graphics capability to match the NLQ printing mode, and an NLQ download character set, giving you a massive 16x23 matrix of dots to define for each character.

I regret that I never had the patience to test this facility!

There is a 'character at a time' printing capability, which allows the Canon to be used like a typewriter, though my brief experiments seemed to generate an

```
!"#$%&'()*+,-./0123456789:;<=>?@ABCDEFGHIJKLMNPOQRST
UVWXYZ[ @]_`abcdefghijklmnopqrstuvwxyz$!~"
Can you tell one from lower-case ell and oh from zero ?

Capital I
Small l
Number 1
Capital O
Small o
Zero 0

I11 - 00o 101010101010
```

Figure 5. Sample character set and the 'ello'ello'ello test

the Juki dump printed in the January issue. It uses ESC HS(31) to control horizontal paper movement and ESC US(30) to control vertical movement, and prints a full stop for a dot, and a space for no dot.

I found annoying the fact that the printer was off line when switched on, and needed a touch on the switch panel before it would operate. There's a 'set page' button on the front panel to set 'top

of form' at the current paper position.

The Oume Courier 10 print-wheel supplied has some curious features; there are, for example, strange characters in some of the ASCII punctuation positions, I and l are indistinguishable, and numbers are bigger than letters. Friction feed is the only option at present, though tractor and cut-sheet feeder attachments, also at reasonable prices, are on their way.

The manual is a tatty multi-language

document, of which only 20 pages are in English, and several of those are about esoteric details of interfacing. If all the translations are as bad as the English, there will be some confused users around the world. No programs, and not much help.

By any standards 18 cps is slow, but if you must have a daisywheel printer for business use, this is the cheapest I have yet seen, and is perfectly adequate.

```

10 MODE2
20 PROCCENTRE("SANPLE daisy step",6)
30 FOR I=1 TO 7
40 PROCCIRCLE(80+80*I,150+50*I,60*I,I)
50 NEXT
60 FOR I=6 TO 1 STEP -1
70 PROCCIRCLE(640+80*(7-I),500+50*(7-I),60*I,I)
80 NEXT
90 PROC DUMP
100 END
110
120 DEFPROCIRCLE(X,Y,R,C)
130 GCOLR,C
140 MOVE X+R,Y
150 FOR th=0 TO 360 STEP 8
160 Xl=X+R*COS(th*PI/180)
170 Yl=Y+R*SIN(th*PI/180)
180 DRAW Xl,Yl
190 NEXT
200 ENDPROC
210
220 DEFPROCENTRE(T$,C)
230 COLOUR C
240 PRINTTAB(10-INT(0.5*LENT$),1)T$
250 COLOUR 3
260 ENDPROC
270
1000 REM SANDUMP
1010 REM G.B.Hill (C) 1983
1020 REM dump for the SANPLE daisy step 2000
1030 DEFPROC DUMP
1040 REM Enable printer
1050 VDU2,1,13,1,13,1,13
1060 REM ESC US 3 to set horizontal spacing
1070 VDUL,27,1,31,1,3
1080 REM ESC RS 1 to set linefeed
1090 VDUL,27,1,30,1,2
1100 FOR Y%=1023 TO 0 STEP -4
1110 FOR X%=0 TO 1279 STEP 4
1120 IF POINT(X%,Y%)>0 THEN VDUL,46 ELSE VDUL,32
1130 NEXT
1140 REM Linefeed
1150 VDUL,13
1160 NEXT
1170 REM Reset printer, disable and beep
1180 VDUL,27,1,30,1,9,1,27,1,31,1,13,3,7
1190 ENDPROC
    
```

Program 1. A graphics routine and dump for the Sanple and other daisywheels

page 151 ▶

MAKING A HASH PRINTING A POUND

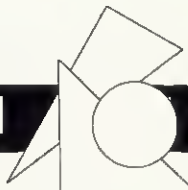

WE get a number of queries about the possibility of printing the # and £ signs in the same piece of text. This can be accomplished in a number of different ways. The normal arrangement for dot matrix printers is to have the printer supplied with the £ sign printing as character 35. The first thing I do when taking delivery of a printer is to change the DIP switches from the English character set to the USA set. This gives me # and \$ signs as on the keyboard. However I have not yet found a printer that gives me the £ sign as character 96 (the value given by the £ key on the Beeb).

What to do? There are a number of possibilities.

1. If you have download characters, then re-define character 96 to be the £ sign, and all will be well. The codes to do this on the FX80 and Canon are in program 2. Run program 2 as a start-up option whenever word processing is to be undertaken.
2. You can, within a word processing environment, normally send escape

sequences. The series of codes to cause a switch from # to £ is as follows:

- ESC "R" 3 (switch to UK)
- 35 (# character code)
- ESC "R" 0 (switch back to USA)

If you have decided to leave the UK character set active, then the sequence to obtain the # would be:

- ESC "R" 0 35 ESC "R" 3
- 3. On some printers (the Seikosha, FX80 and Canon, for example) the extra characters can be printed by codes greater than 128. On the FX80 and

Canon the code is 134, after the full character set has been copied into RAM.

4. Method 2 may be applied on some daisywheels, depending on the wheel. The Juki wheel allows international character-set switching. The Sanple and Oume wheels generally do not, though the ESA wheel does have both symbols, but you lose many others, including < >.

A knotty problem, and you have to work out which solution suits you best. At worst, you can always print a space, and write in the missing symbol.

```

10 REM Enable printer
20 VDU2
30 REM Copy ROM characters into RAM
40 VDUL,27,1,ASC":",1,0,1,0,1,0
50 REM Select RAM characters
60 VDUL,27,1,ASC"%",1,1,1,0
70 REM Redefine character 96
80 VDUL,27,1,ASC"&",1,0,1,96,1,96
90 REM Send codes for pound sign
100 VDUL,138,1,18,1,0,1,126,1,128,1,18,1,128,1,18,1,128,1,66,1,0,1,0
110 REM Disable printer
120 VDU3
    
```

PUN
PPINTCHR#35;CHR#96;"#£#£#£"
##£#£#£#£

Program 2 and RUN. Sets up the £ key to print the £ sign on the FX80 or Canon PW1080A printer

ALLIGATA THE SOFTWARE
WITH BITE
BRINGS YOU

DAMBUSTERS

FREE

COMPETITION
WIN A TRIP
TO GERMANY

The highest scoring player on Dambusters will win a free holiday in Germany accompanied by a friend. Full details and entry form are available with every Dambusters program. So hurry, get your copy today and start practising.

ALSO AVAILABLE

B19 NEANDERTHAL MAN £7.95
Relive the dangers of primitive man - whilst foraging for food for your family you've only a spear to protect your family from the prehistoric monsters.

B07 LUNAR RESCUE £7.95
Land your moon buggy and rescue a precious cargo, destroying all opposition on the way, finding your way back to the mother ship start again against greater odds.

B12 PRIMARY ART £7.95
Create a picture to be proud of - place pre-programmed shapes in any position, any size or any colour. Features free-hand drawing and animation effects.

B03 DMON £7.95
Disk **£11.95** ROM **£19.95**
A superb machine code monitor and disassembler available on BBC. Features: Full disassembler with ASCII dump; full hex dump with ASCII; reads any ROM, edits any byte of RAM, and many more.

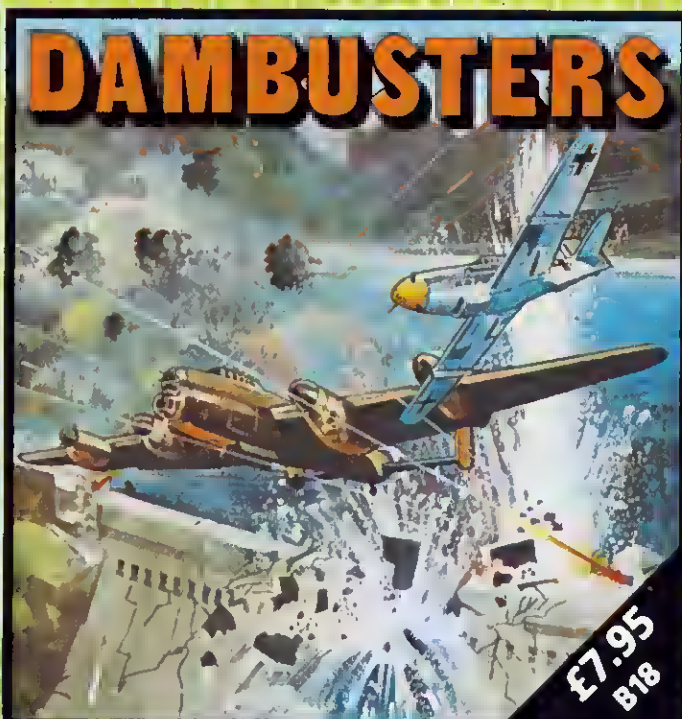

£7.95
B18

Harried by night-fighters, bombarded by heavy anti-aircraft fire pilot your bomber through the treacherous valley and deliver the revolutionary bouncing bomb on its path of destruction.

THE
DEVASTATING
NEW GAME
FOR
BBC (Model B)

Alligata presents a superb range of software products that are designed specially for you. Games that cleverly combine full machine code and high resolution, full colour graphics to create hours of fun and excitement. And utilities that have been developed to open new doors and help get the best from your BBC (Model B) micro. If it's to be outstanding quality and amazing value for money then Alligata has to be your choice.

Send a stamped addressed envelope for our full colour catalogue which gives details of the complete range.

WRITE OR PHONE
YOUR ORDER TODAY!

also available from all
good software stockists.



£7.95
B16

Fight your way through four action packed levels of attack from the menacing phoenix and battle armed eagles, before you can blast to destruction the heavily armoured and strongly defended Eagle Empire.



£7.95
B11

A superb action packed arcade special. A really fast implementation of the splendid 'centipede'. Features include spiders, mushrooms, centipedes and the mushroom poisoning scorpion affectionately known as 'Brian'.



£7.95
B15

Qualify in under 60 seconds for the race of a lifetime - fantastic speeds, death-defying manoeuvres and a narrowing circuit - an exacting challenge for a future world champion.



£9.95
B20

The ideal opportunity to improve your technique in a sophisticated program where the computer bids and plays the other three hands.

Despatch is normally made on receipt of order and should reach you within 7 days.

INDICATE PROGRAMS REQUIRED

B18 B16 B11 B15 B20 B19 B07 B12 B03

I enclose cheque/PO* for £ _____ Charge my Access/Visa £ _____

Card No. _____ Signature _____

Name _____

Address _____

*payable to Superior Systems Ltd., 178 West Street, Sheffield S1 4ET.
allow 75p for post and packaging.



Alligata Software Ltd. 178 West Street,
Sheffield S1 4ET. Tel: (0742) 755005

LVL COMPUTERTOWN

Whether its your first computer or whether you're already an enthusiast, LVL COMPUTERTOWN offers you the quality of service you expect from experts. If you invest money, you go to a bank or a broker - a specialist who can guide and advise you on the best return for your capital. At LVL COMPUTERTOWN we're specialists too. We're there to help guide you through the micro maze, keep you up to date on innovations, help you get the best value for money, whether your computer is for you, your children or your business. Your computer can change your life - make sure you change it for the better: Come and talk to the experts and move into micros with LVL COMPUTERTOWN

COMPUTERS



£199.00



The new personal computer from Acorn Computers. An ideal machine for learning computing - and for having a lot of fun at the same time. But it's much more than just a toy. It's graphic facilities are the most sophisticated available in it's price range.

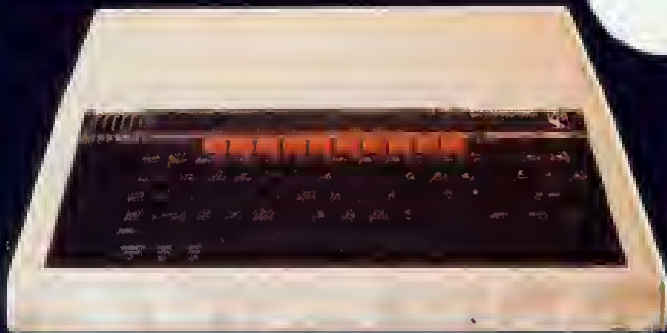

BBC MICROCOMPUTER

MODEL A	£299	MODEL B with DOS	£469
MODEL B	£399	Model B with DOS & ECONET	£516
MODEL B with ECONET	£446	£516

MONITORS



DECCACOLOUR

14" Colour Monitor

£247.25



SAB

14" Colour Monitor/Colour

£274.4



MICROVITEC

14" Colour Monitor

£247.25



SANYO

12" Green Screen

£102.35

PRINTERS



Seikosha GP100A	238.05
Silver Reed EX500	
Parallel	343.85
Silver Reed EX500	
Serial	378.35
Silver Reed EX550	
Parallel	534.75
Silver Reed EX550	
Serial	569.25
Epson RX80	320.85
Epson FX80	503.70
Epson RX80 (F/T)	366.85
Epson MX100 (B2 Col)	546.25
Epson FX100	854.35



DATA RECORDERS



A REFLECTION OF SUPERIORITY

The Bell & Howell/LVL Computer Compatible Data Recorder

£39.95

- Automatic Level Control
- Automatic Tape Stop
- Tape Counter
- Remote Motor Control

DISK DRIVES



An example of superior technology, total reliability and outstanding performance, combine to produce the LVL Disk Drive Family.

Truly professional units designed to work with the BBC Microcomputer.

CHECK OUT NEW LOW PRICES WITH YOUR NEAREST DEALER.

SOFTWARE

DESIGNED FOR THE BBC MICROCOMPUTER

ACORN SOFTWARE GAMES

Hopper

for the BBC Microcomputer Model B

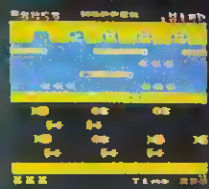

LANGUAGES

- ASP £16.95
- BIRTH £15.95
- GAMES
- Monsters £9.95
- Hopper £9.95
- Planetoid £9.95
- Crade Action £11.90
- Cricket Raid £9.95
- Steers £9.95
- Scadians £9.95
- Crading-Block Puzzle £9.95
- Crabe Master £9.95
- Crarship Command £9.95
- Crrocker £9.95
- Cruper Invaders £9.95
- Crupper £9.95
- Crlditz £9.95
- Crctor Who £10.00
- Crute Knight II £12.00
- Crssile Base £9.95
- Crughts & Reversi £9.95

ADVENTURES

- Philosophers Quest £9.95
- Castle of Riddles £9.95
- Countdown to Doom £9.95
- Sphinx Adventure £9.95

GENERAL

- Desk Diary £9.95
- Creative Graphics £9.95
- Graphs & Charts £9.95
- Tool Box £21.00
- Record Keeper £13.80
- Magic Garden £9.95

EDUCATIONAL

- Map References £7.50
- Lasermaths £7.50
- Classmaster £20.00
- Algebraic Manipulation £9.95
- Word Sequencing £11.90
- Missing Signs £11.90
- Number Balance £11.90
- Word Hunt £11.90
- Density Circuit £11.90
- Chemical Analysis £13.80
- Chemical Structures £13.80
- Jars £11.90
- Vu-Type £16.10

ALL PRICES INCLUDE VAT.

The items featured represent a very small selection from our vast product range, and at the time of going to press were all available from stock. However, not all dealers carry every advertised item, please telephone before making your journey. Further information of both product and services available can also be obtained by telephoning or visiting your nearest LVL Computertown dealer.

CHESHIRE

C-TECH SOFTWARE
184, Market St.
HYDE
Cheshire
061 366 8223

- COMPUTER CITY
78, Victoria Rd.
WIDNES
Cheshire
051 420 3333

CUMBRIA

- THE COMPUTER SHOP
58/58 Lowther St.
CARLISLE
Cumbria
0228 27710

ESSEX

A.C.I.
1, Northmill
GRAYS, ESSEX
0375 76834
BROADWAY MUSIC
AND VISION
Woodford Green
ESSEX
01 504 7500

GREATER MANCHESTER

- LOMAX
8, Exchange St.
St Annas Square
MANCHESTER
061 832 6187

WORCS

- SPURTREE COMPUTING LTD
Council Buildings,
Teme Street,
TENBURY WELLS,
Worcestershire
0584 811353/811304

MERSEYSIDE

• THORNGUARD
48, Penaby Rd.
HESWALL
The Wirral,
Merseyside
051 342 7516

NOTTS

S P ELECTRONICS
48, Lunby Rd.
HUCKNALL
Notts.
0602 640377

COMPUTERTOWN (UK) LTD.
230, Derby Rd.
STAFLEFORD
Notts.
0602 398484

OXFORD

ABSOLUTE SOUND
AND VIDEO (Oxford) Ltd
19, Old High St. Headington
OXFORD
0865 65961

AVON

K & K COMPUTERS
32, Alfred Street,
WESTON
SUPERMARE
Avon
0934 419324

COLSTON COMPUTER
CENTRE LTD.
The Colston Centre
11, Colston Ave.
BRISTOL
0272 276619

YORKSHIRE

HOME & BUSINESS COMPUTERS
68, Daley Hill
DEWBURY
Yorks
0824 488300

WEST MIDLANDS

JBC MICRO SERVICES
200 Earlsdon Ave.
Nth. Earlsdon
COVENTRY
0203 73813

WILTSHIRE

WILTSHIRE MICRO
CENTRE
Unit 8,
Central Trading Estate,
Signal Wsy,
Old Town,
SWINDON
0793 612288

BUCKS

HI-VU ELECTRONICS
38, Church St. Wolverton
MILTON KEYNES
Bedford
0908 312808

SUSSEX

CJE MICROS
78, Brighton Rd
WORTHING
West Sussex
0903 213900

ISLE OF WIGHT

EXCELL
4, Foreland Rd.
BEMBRIDGE
Isle of Wight
098 387 2378

YOUR LOCAL



DEALER

HEREFORD

KEMPSONS
26, St. Owen St.,
HEREFORD
0432 273480

KENT

KENT MICRO
57, Union St
MAIDSTONE
Kent
0622 52784

GRAVENSND
COMPUTERS
39, The Terrace,
GRAVENSND
0474 50677

LEICESTER

PERCY LORD & SON
63, Slaby Rd
WIGSTON
Leicester
0533 785033

LONDON

CANNONBURY RADIO
185 Upper St
ISLINGTON N1
London
01 226 6392

PAUL ELECTRICAL
250/2, Grand Drive,
Raynes Park,
LONDON SW20
01 542 8546

WOODS RADIO
257, Lavender Hill
Battersea,
LONDON
01 228 1768

SALOP

MEDLICOTT BROS
53, Mardol
SHREWSBURY
Shropshire
0743 3060

SUFFOLK

S J EMERY & CO
10, Market Place
BUNGAY,
Suffolk
0986 2141

IRELAND

EVERYMAN COMPUTER
SERVICES
BALLYMONEY
Co-Antrim
N. Ireland
028 56 82658

STAFFS

T W BAGNALL
18, Salter St
STAFFORD
0785 3420

KIRKLANDS

City Rd., Fenton
STOKE ON TRENT
0782 415787

• COMPUTERAMA
59, Foregate St
STAFFORD
0785 41888

SURREY

- HASLEMERE COMPS
25, Junction Place,
HASLEMERE
Surrey
0428 53880
- P & H ELECTRONICS
5, The Parade,
Resding Road,
YATELEY
Surrey.
0252 - 877 222

LANCASHIRE

• P V MICROS
38A Water St
ACCINGTON
Lancs
0254 36521

• Home & Business
Computers Ltd.
54, Yorkham Street,
OLDEHAM
061 633 1608

Home & Business
Computers (RCH) Ltd.
73, Yorkshire Street,
ROCHDALE
0706 344654

WALES

S I R
91, Whitchurch Rd.
Cyncoed
CARDIFF
Wales
0222 621813

THE COMPUTER SHOP
41, The Hayes,
CARDIFF,
Wales.
0222 28888

SCOTLAND

COMMSCOT
30 Gordon St
GLASGOW
041 226 4876

NORTH LAND

NEWTONS
Main St.
SEAHOUSES
0685 720307

GRAFPAD

...for as many uses
as YOU
can imagine!



BBC MODEL 2 • SPECTRUM COMMODORE 64

With Grafpad you can now add a new dimension to your computer enjoyment, but most important, it helps you create your own application programmes by the simple use of the Grafpad!

The Grafpad comes complete with a cassette comprising two programmes.

THE FIRST PROGRAMME

displays the co-ordinates of your screen area. The co-ordinates are based on the screen with a grid size of 1023 x 1279 pixel, also in the Grafpad giving you a grid size of 320 x 256 pixels!

THE SECOND PROGRAMME

provides you with the utilities for circles, squares, triangles, free-hand, erasing line-drawing etc, and of course, full "Fill-in" facility in 16 different colours by the simple use of the pen!

Draw from a simple apple to a computer circuit - store in cassette or disk, perhaps transfer direct to a printer - in black and white or full glorious colour!

Purchase unique C.A.D. (Computer Aided Designs) programme and add further enjoyment and professionalism to your computer designs!

The Grafpad comes complete with Operational Manual, Programmes, The Grafpad and Pen and it simply plugs in your computer.

(Size: 25mm height x 55mm width x 260mm depth)
Weight: 1.2 kg (Gross)

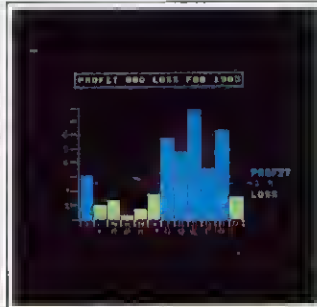
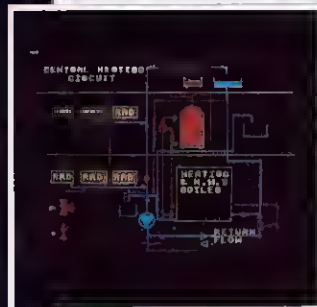
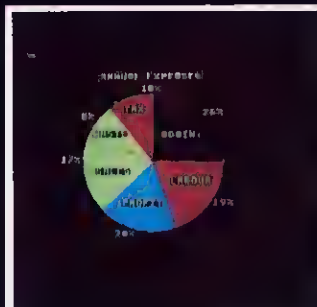
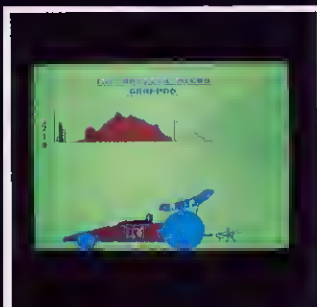

HOW TO ORDER:

BY TELEPHONE:
If you are an American Express, Barclaycard, Diners Club or Access Card Holder simply telephone us giving your Card No., Name, Address and item(s) required and your orders will be dispatched within 48 hours!

BY POST:
Simply fill in the coupon, enclosing your cheque/P.O. made payable to: BRITISH MICRO, or use the special section for Credit Card Holders, and post to the address below. Please allow 14 days for delivery.

(The above designs were drawn by a 12-year-old at our showrooms!)

- DEALER INQUIRIES WELCOMED
- SPECIAL DISCOUNTS FOR EDUCATIONAL AUTHORITIES

BRITISH MICRO

A HEGOTRON GROUP COMPANY

Unit Q2, Penfold Works,
Imperial Way, Watford, HERTS WD2 4YY
TEL: (0923) 48222. TELEX: 946024



Post to: BRITISH MICRO, UNIT Q2, PENFOLD WORKS
IMPERIAL WAY, WATFORD, HERTS. WD2 4YY

Please send me Grafpad for:

BBC MODEL 2 SINCLAIR SPECTRUM COMMODORE 64
(Please tick)

Qty.	Item	Ex. VAT	Inc. VAT	Total
	Grafpad Complete	£125.00	£143.75	
	C.A.D. Programme	£18.00	£20.70	

Postage, Packing & Insurance £5.00

I enclose my cheque/P.O. for £..... TOTAL £

I prefer to pay with my American Express, Barclaycard, Diners, Access Card
(Please cross out whichever is not applicable)

CARD NO. _____

SIGNATURE _____

NAME _____

ADDRESS _____

Address above must be the same as card holder.

SAMPLE
daisy step

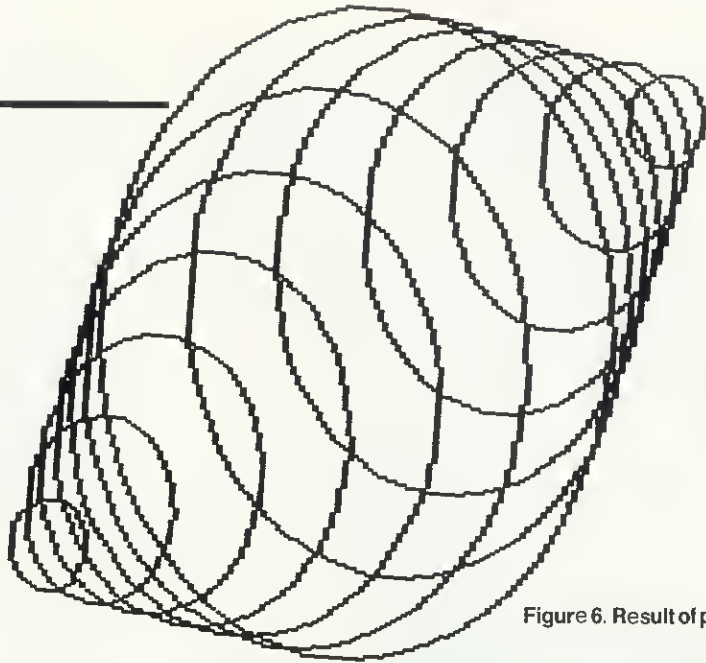

Figure 6. Result of program 1

STOP WATCH ON PRINTERS

HELP US COMPILE A LEAGUE TABLE

MANUFACTURERS are invariably over-optimistic about the speed at which their printers will operate. When you buy a printer with a quoted speed of, say, 160 characters per second (cps) what does this mean? Normally it is based on the maximum speed that the printer is capable of, with no linefeeds and, in the case of daisywheel printers, no letter changes. These conditions are simply unreal. I am interested in compiling a league table of printer performance.

Program 3 is a short test routine which prints 25 lines of 80 characters. I have chosen two characters (*x) with ASCII codes fairly widely separated to give more realistic results with daisywheel printers, where character switching is mechanical and therefore slow.

The procedure is analogous to the PCW Benchmark programs for testing computer performance. You need a stopwatch to time the printer. I tried a program using the TIME function on the BBC, but the results are grossly distorted

by the different buffer sizes of the printers. A large buffer results in almost instant transfer of information to the printer and so gives a big advantage, making the micro available for other purposes. Here, however, we are interested in how rapidly the printer actually prints! The method is as follows:

1. Run the program, starting the stopwatch on the first beep from the printer, or the printing of the first *.
2. Stop the stopwatch when the second beep is heard from the printer, or when the final x is printed.
3. Record the time taken.
4. Calculate the speed by the formula 'speed = 2000/time'.

Results for the Star Delta 10 (reviewed in the April issue), Canon PW1080A and the Sample Daisy Step 2000 are shown in the panel.

Readers are asked to send results for other printers. Address them to 'Benchmark', *Acorn User*, 68 Long Acre, London WC2. All we need to know is:

1. Name and address.
2. The maker's name and the model number of the printer.
3. The manufacturer's quoted speed from the manual or the advertising.
4. The printout produced by running the Benchmark program (program 3).
5. The time taken, and your calculated value of the speed in cps.

Please don't send in your results in the form of a long letter!

```

10 REM Printer Benchmark
20 REM Time taken to print
   25 rows of 80 characters
30 VDU2,1,7,1,13
40 FOR I=1 TO 25
50 FOR J=1 TO 40
60 VDU1,42,1,120
70 NEXT
80 VDU1,13
90 NEXT
100 VDU1,7,1,13,3

```

Program 3. Benchmark test routine for printers

PRINTERS' REAL TIME

MAKER	MODEL	MODE	advertised speed (cps)	time (BM)	cps (BM)
Canon	PW1080A	normal	160	20.00	100.0
		NLQ	27	77.75	25.7
Sample	D/S 2000	normal	18	190.95	10.5
Star	Delta 10	normal	160	20.69	96.7

??

Do you ever wonder what you spend on clothing?
Do you need to know how much money will be
in your bank account at the end of the month?

Do you have a part time business?
Do you run the books for a club or society
Do you make VAT returns?

THEN YOU NEED THE

HOME ACCOUNTANT

for only £19.95 (including VAT)

Cassette or Disk versions for the BBC Model 'B'
(or Model 'A' with 32k RAM)

This package - complete with 41 manual

- keeps a 24 column analysed account of payments and receipts*
- calculates the VAT owed/owing
- produces printed accounts
- handles regular payments automatically

* Each column in turn could be analysed further by creating new accounts

Send cash/cheque to the Acorn distributor for the
North West and Wales



System Support Services
Brook House, 513 Crewe Road,
Wheelock, Sandbach,
Cheshire CW11 0QX
Telephone (09367) 3842 & 61249



Pilot written.....

767

ADVANCED FLIGHT SIMULATOR

Comprehensive, well documented package.
This is undoubtedly the most advanced,
realistic simulation for your BBC Micro -
superb graphics - full instrumentation,
3D landing sequence, autopilot, ILS, VOR
etc. Joystick option. When you have flown
767 the only next step is the real thing!

For model B.

Chq. or PO
£8.75

FLIGHTDECK
SOFTWARE,
Dept. 767,

25 Halsey Road,
Kempston, Beds. MK42 8AP



EXPANDABLE CONSOLE FOR BBC MICRO

As supplied to Universities, Colleges, Schools,
business & home users

A professional console to house
disc drives/2nd processor/Torch
dual drives/Teletext, etc. All untidy
wiring out of sight in the strong
aluminium console in a matching
textured colour. AVAILABLE NOW
a bolt on extra module for extra
expansions.

Also available a matching printer
stand, yes stack your paper under
the printer.

ALSO VDU STANDS AVAILABLE

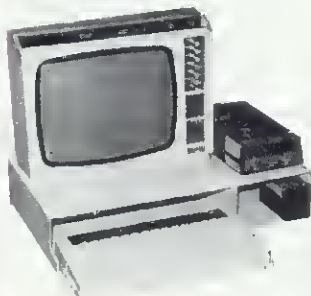

ELECTRON CONSOLES

The console houses the electron
and will safely support the expansion
interfaces which plug into the
rear of the micro, supports the
VDU and tidies up all wiring, allows
expansion to disc at a later date.

PRICES

Special Torch Version £46.99 + £4 p/p
BBC Console £44.99 + £4 p/p
Bolt on expansion £14.99 + £2 p/p
VDU/Printer Stand £14.99 + £2 p/p
Electron Console £34.99 + £4 p/p

Please add VAT @ 15% to all prices

For further information enclose sae or send cheque to,

Mail Order Only **Silent** 01-801 3014 27 Wycombe Rd
London N17

Viewing by
arrangement

COMPUTERS

24 hour
ansaphone

Please allow 28 days for delivery

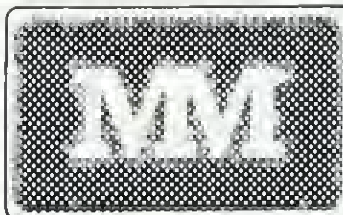

TOP SAVINGS

	EX VAT	INC VAT
PRINTERS		
BROTHER HR 15	349.00	401.35
TRACTOR	68.00	78.20
SHEETFEEDER	195.00	224.25
KEYBOARD	142.00	163.30
EPSON RX80T	215.00	247.25
EPSON RX80F/T	242.00	278.30
EPSON FX80P/T	329.00	378.35
EPSON MX100F/T	375.00	431.25
EPSON FX100F/T	430.00	494.50
FX80 TRACTOR	30.00	34.50
JUKI 6100	345.00	396.75
MANNESMANN TALLY MT 80	199.00	228.85
OKI MICROLINE 80AP	180.00	207.00
OKI MICROLINE 82A	289.00	332.35
OKI MICROLINE 83A	435.00	500.25
OKI MICROLINE 92P	395.00	454.25
SEIKOSHA GP 100A	175.00	201.25
SHINWA CP80	175.00	201.25
STAR GEMINI 10X	199.00	228.85
COMPUTERS		
COMMODORE 64	156.51	179.99
COMMODORE 1541 DISK	165.21	189.99
COMMODORE C2N CASSETTE	36.51	41.99
INTFACE 64-PAREL	59.50	68.43
APRICOT *D*MON	1575.00	1811.25
SANYO MBC555	799.00	918.85
EPSON OX10	1600.00	1840.00

MAYFAIR MICROS
362 YORK ROAD, LONDON SW18 1SP
01-870 3255

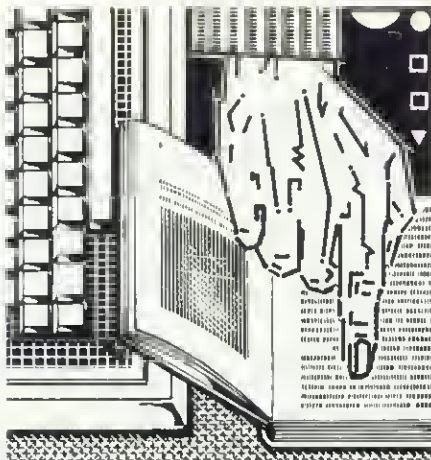

KEEP YOUR

MICRO GUESSING

'Micropuzzles' by J J Clessa (Pan, £2.95), 'Brainteasers for the BBC and Electron Computers' by G Ludinski (Phoenix, £5.95) and '101 Puzzles to Solve on your Home Computer' by Andrew Hilton (Harrap, £4.95)

THESE three books provide a good cross-section, both in state-of-the-art puzzle books and in computer book publishing. In no case does the price of the book generally provide any accurate guide to the quality of the contents. I shall begin with the least expensive and work upwards.

Micropuzzles is part of the Pan PCN Library – a series launched fairly disastrously last autumn. Since then two titles have had to be pulped because of the extraordinary number of errors and no-one is very happy with what's left. *Micropuzzles* is probably the best of a bad bunch. It consists of a straight reprint of the puzzles set by J J Clessa over the years in the 'Leisure Lines' feature of *Personal Computer World*.

You get 144 pages for your money. The first part of the book consists of 70 'quickies' – so named because you are expected to solve them in your head or employ a little lateral thinking. Most of them are rather well known – eg, 'What weighs more, a pound of feathers or a pound of gold?', a puzzle I recall reading in *Reader's Digest* when I was about six – and who knows where they got it from? I cannot see the point of including this sort of thing in a 'computer library', unless, that is, you need to pad out the book.

For the record, there are 60 puzzles that are soluble by computer, though in several cases the author says that doing it logically with pen and paper is more efficient! One hopes that Pan, arguably the most impressive and professional of UK paperback houses in most areas, will take rapid steps towards improvement.

101 Puzzles to Solve On Your Micro-computer is the best-produced of this trio. It has the largest format of the three – A4 size – and each question is accompanied by a cartoon. A nice touch is the spiral binding, which enables the reader to

leave the book lying open while constructing a program to solve the problem. If I have a criticism it is that the author has found it difficult to make all his puzzles original: he ingeniously sidesteps this point by dedicating the book to Lloyd and Dudeney, the most creative people ever to construct puzzles. And, it must be admitted, coming up with 101 new ideas would stretch the ingenuity of most people.

It's no coincidence that the famous problem about the five castaways, the monkey and the coconuts – an ideal problem for a computer – appears both in Clessa's book and in this one. Still, they're in good company. Last summer, *The Sunday Times* Brainteaser, normally rather an original source of intellectual stimulation, used it.

Andrew Hilton has done a good job in sorting his puzzles into number-crunchers, problems involving the use of nine or ten different digits once only, exercises in probability and codes and ciphers. His book probably represents the best value for money of all three.

Brainteasers at £5.95 is the most expensive; its author claims to specialise in marketing educational software. Instead of a series of puzzles with answers at the back, this book consists of a series of games that you type in from a listing of a Basic program. The publishers have sensibly printed the listings directly rather than entrust them to a typesetter, but they used a cheap printer, so the result is messy and difficult to read.

The games are the kind that interests people new to the excitement of computers, but most of us grow tired of this sort of thing within a couple of months. In fact, most *Acorn User* readers would be likely to spend more time fathoming out the listings and typing them in than in actually using the software. Still, the enthusiast can save the trouble by sending another £6.95 to the publishers and getting a cassette of the programs. At twice the price of the Pan book, and the same number of pages, this book is really a bit expensive.

Simon Dally

TEACHING YOUR

MICRO TO PLAY

Computer Gamesmanship by David Levy, PCW/Century, 272pp, £7.95.

THIS book is actually a collection of articles written in 1980/81 for *PCW* magazine, presented in 18 chapters. It is fairly comprehensive, the first seven chapters covering the fundamental programming techniques involved in games and various enhancements. The final chapters cover specific games (draughts, chess, backgammon, stud poker, draw poker,

Othello, go-moku, bridge, shogi and dominoes).

The style of writing is active and interesting but there are a few places where time and care should have been used in explanations.

Anyone wishing to write an 'intelligent' game program could use this book. Obviously, every game cannot be covered as thoroughly as in other specific texts, but here in one paperback is all the basic theory, and some of the more advanced techniques. Levy also gives many references to other specific texts, in case you wish to develop your program further. The book may also serve to help beginners decide which sort of game to attempt first, by stating the relative difficulties of each.

Initial chapters tackle minimax tree

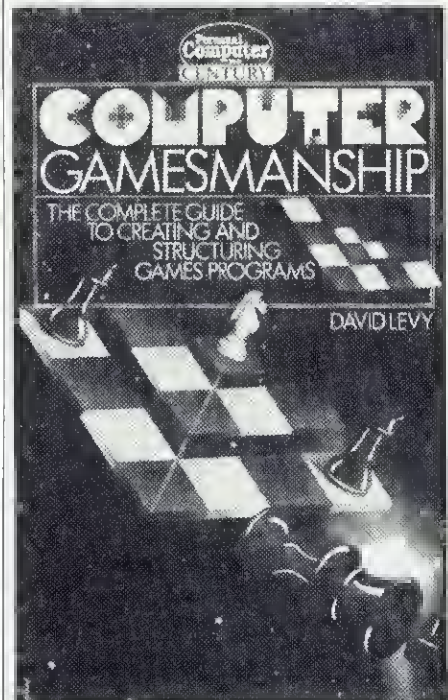

searching for game trees, including the many enhancements such as alpha-beta pruning, move-ordering, the killer heuristic and windowing. The book then continues to explain how to design simple or complex evaluation functions and how to quantify and weight the various relevant factors. It also goes into some algorithms which allow your program to learn, and thus, hopefully, improve its play.

Card game basics are covered, including the relevant probability theory, deducing information from bidding and actual play, expected value trees, psychology and bluffing.

The chapter on Samuels' draughts program is rather bare, considering it was the first to play at a world class standard. Also the awkward data structures in draughts are not mentioned in any way. Chess has the largest coverage, with some interesting game annotations |

page 154 ►

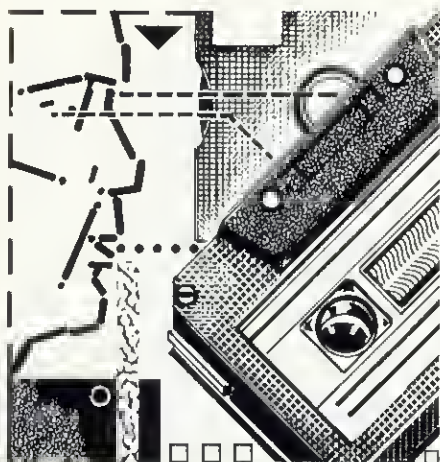

154

PRISONER OF

ZANDOR

'Lost City', Superior Software, BBC B (32k), £7.95

LOST CITY is an almost text-only adventure, in which you have to find the Lost Diamond of Zandor.

Many years ago, Ikan Findem (geddit?), a well-known explorer, set off on an epic quest to find the legendary diamond. For many years he searched, until, one day, he was found in a hot, desolate valley. His dying words were: 'I have found the Lost City'. Anyone who tried to find it was welcome to his equipment.

You are parachuted into the valley and this is where your search begins.

Playing the game is enjoyable, but I

found it frustrating as I couldn't get out of the valley – can anyone help?

The function keys have been set up with commands such as North, Lake, Look, List and Help. This last command can be useful in certain locations, but normally lists the key definitions.

Colour has been well used. In mode 7 there are one or two pictures, and the text is colour-coded according to message type. The messages are put across in a helpful way, too. I felt at ease during my short games – it's just that I'm totally stuck, and you get unexpected messages now and then.

There appears to be no 'save-game' facility in *Lost City*. This would have been useful, particularly in my predicament! That aside, though, the adventure is good, with a fair number of locations (I looked at the listing!). I have to say, however, that at £7.95 *Lost City* is overpriced compared to masterpieces like the original *Colossal Caves*.

Stuart Menges

COLDITZ DODDLE

'Colditz Adventure', Superior Software, BBC B (32k), £7.95

THIS is one of the simplest adventure games I have ever experienced. It took me just over one hour, including mapping time, to complete it.

The idea of *Colditz Adventure* is to escape from the castle with certain

objects vital for survival. You can escape without them but you die by getting lost or starving or meeting some other fate.

The 'problems' I encountered were no problem and required little or no thought to solve. The messages give you such heavy hints that it would be difficult to miss the point. You may have to run through the plot twice to finish, but if, like me, you are cautious you'll be all right.

The screen layout is fairly good. You are told where you can go (in the nicest way) and each direction is in a different colour. Directions may be entered as single letters, although you don't seem to be able to abbreviate nouns. Another niggle is that words were chopped up when a line was full – even IS was split on one occasion.

The screen is quickly cleared and updated after every move, a nice touch which keeps everything neat.

There's a 'save game' facility but I don't think it will be needed. The routine to save is very quick; there are only about 35 things to read or write.

Apart from one or two spelling mistakes the program is well-written in Basic and response is fairly quick. A bit of thought could have reduced the size of the program a little. However, for the Basic adventure writer there are a few good routines here.

To sum up: good for beginners or programmers, but a little too simple, and it should be more user-friendly.

Stuart Menges

◀ page 153

hadn't seen elsewhere. All the major stages in computer chess development are mentioned. The backgammon chapter is now rather outdated as Berliner's program BKG 9.0 won the world championship after the articles were written. (This program has been the subject of an article in *Scientific American* which is better than Levy's chapter.)

Stud and draw poker are covered in an interesting way, although once again, Levy mentions some problems with the 'bluff' aspect, but fails to suggest any real solutions. However, I'm sure these two chapters would help many people write good poker programs. Othello is given a good airing, and many people who have not written any strategy games programs before may find this an ideal start. The gomoku suggestions are reasonable but not really adequate. The game is easy to program for legal play, but very difficult for strong play. The two bridge chapters (one on bidding, one on play) seem very inconcise. This is probably because the game is, as stated, very difficult to program well.

Shogi is covered in the best way – referral to other more detailed texts! This game of Japanese chess is probably totally alien to most British people and so it

would be very difficult to say the best way to program it. I imagine anybody who seriously attempted writing a shogi program would soon become one of the experts in the western world, with more being learnt from experience than from Levy's chapter.

Finally, dominoes is given a thorough computer strategy, fairly easy to program, which as Levy states, if used 'would probably produce a program of world championship calibre!'

A lot of development work has been done over the past three years in the field of artificial intelligence in games programs and so the book is certainly lagging behind in several aspects. I would have preferred to see some changes to the original articles to reflect the latest major developments.

Still, the book is quite good value for £7.95.

Martin Bryant

BASIC ABC

'BBC Basic for Beginners' by David Smith, Melbourne House, 315 pages, £6.95

BEARING in mind the complexity of the BBC micro and its wide appeal, the *BBC User Guide* cannot meet the needs and abilities of all potential buyers. And this is

where David Smith's book comes in, for it is clearly aimed at those who find the *User Guide* difficult and daunting, particularly those who are new to computing.

BBC Basic for Beginners is divided into three sections. Section A covers the bare essentials of BBC Basic needed to write elementary programs; section B deals with more advanced facilities and programming constructs (eg, sound, procedures and arrays etc), and the final section tackles weighty areas such as the teletext mode, user-defined characters, error-handling and data-files.

Each chapter is interspersed with exercises or more lengthy projects to consolidate the topics covered, with model answers at the end of the book.

On the whole, this is a well-paced introduction, with a clear and thorough style. The later chapters cover topics which even supposedly advanced volumes tend to omit (for example, random access file handling), and should provide a useful source of development material once the basics have been absorbed.

So, if you're still struggling with the *User Guide* that you got with your Christmas Beeb, the gentler introduction of *BBC Basic for Beginners* is just the sort of book you need.

Vincent Fojut

MICROVITEC WIN

THE QUEEN'S AWARD

FOR TECHNOLOGICAL ACHIEVEMENT
THE RANGE OF COLOUR MONITORS MANUFACTURED
BY MICROVITEC ENABLES THEM TO BE USED WITH
MOST POPULAR MICRO COMPUTERS



MICROVITEC
CUB
COLOUR DISPLAYS

Microvitec PLC., Futures Way, Bolling Road, Bradford, West Yorkshire, BD4 7TU, England.
Tel: (0274) 390011 Telex: 517717

SPECIAL OFFER!
Deduct £1 per cassette when ordering 2 or more.

THE BEST BBC

★ PRODUCED BY AN INDEPENDENT SOFTWARE HOUSE

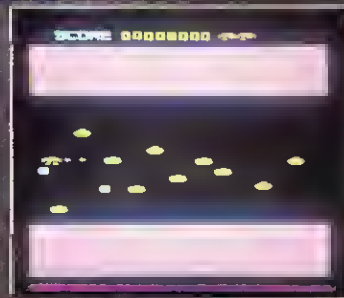
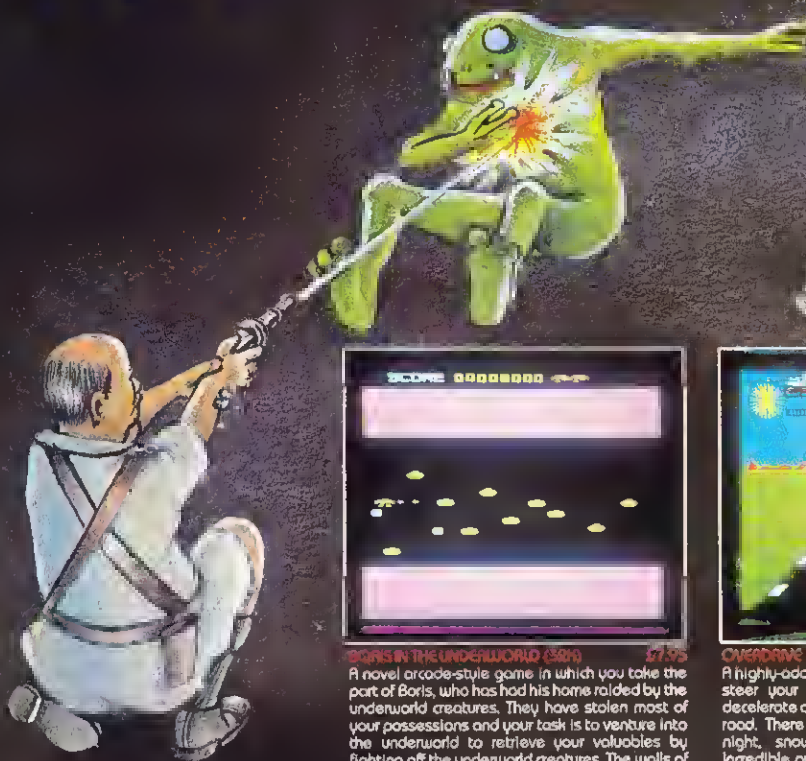

BOYS IN THE UNDERWORLD (38K) £7.95
A novel arcade-style game in which you take the part of Boris, who has had his home raided by the underworld creatures. They have stolen most of your possessions and your task is to venture into the underworld to retrieve your valuables by fighting off the underworld creatures. The walls of the underworld close in and you will be vapourised if they touch you. Can you retrieve all of Boris's possessions from the underworld?
●●●NEW RELEASE●●●



OVERDRIVE (32K) £7.95
A highly-addictive multi-stage 3D race game. You steer your car left and right, accelerate and decelerate as the opposing cars weave about the road. There are five different stages including night, snow, desert, and riverside scenes. Incredible graphics give the impression that you really are taking part in the race. Highly recommended, and destined to become another top-seller for Superior Software.
●●●NEW RELEASE●●●



BATTITANK (32K) £7.95
An excellent game, made possible on the computer only by the unique use of a dual-screen display and specially written plotting routines. You are a tank gunner looking out onto a mountain plateau. You see the distant mountains and pyramid obstacles - and also the enemy. Position the tank in the rectangular viewingfinder, make fine adjustments of your controls...then fire! (KEYBOARD or JOYSTICKS).
●●●NEW RELEASE●●●



ROCKY (32K) £7.95
A new concept in arcade-style games. Your task is to save yourself from patrols of mutant robots by dropping rocks on them. Each of the robots has a single large eye which emits a yellow beam of light. Being caught in this beam reduces your strength and, if you are not carrying a rock, causes the robot to metamorphose. It may change into either a spectre or a cruncher.
(KEYBOARD or JOYSTICKS)
●●●NEW RELEASE●●●



MOON MISSION (32K) £7.95
Moon Mission is a fast-action machine-code game featuring superb graphics, sound effects, hi-score, and rankings. Your mission is to rescue the six astronauts stranded on the moon by steering your spaceship through the meteors and space-mines. The game starts relatively slowly, but from sheer speed not only does the speed increase, but also the number of meteors, space-mines, enemy spaceships, and fireballs.
●●●NEW RELEASE●●●

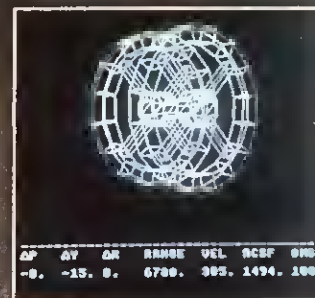

SPACE DOCK (32K) £7.95
A space docking simulator using 3D graphics to model the motions and responses of the ORP spacecraft. Your mission is to pilot the shuttle "soft dock" with the space station. PITCH, ROLL, FORWARD, LATERAL, and VERTICAL engines are provided together with orbit manoeuvre booster engines. 6 skill levels provide for a completely inexperienced pilot as well as the fledged commander.

OTHER TITLES AVAILABLE:

SPITRAE COMMAND £7.95
MISSILE STRIKE £7.95
CENTIBUG £7.95
FROGGY £7.95

ALIEN DROPOUT £7.95
GALAXY BIRDS £7.95
INVADERS £7.95
SPACE FIGHTER £7.95

PLANETARIUM £7.95
FAIRGROUND £7.95
FRUIT MACHINE £7.95
STANDED (Adventure) £7.95

WE PAY UP TO 20% ROYALTIES FOR HIGH QUALITY BBC MICRO.



SUPERIOR SOFTWARE LIMITED,
Dept. AU5, Regent House,
Skinner Lane, Leeds LS7 1AX
Telephone: 0532 459453

OUR GUARANTEE

- (1) All our software is available before we advertise.
- (2) All our software is despatched within 48 hours by first-class post.
- (3) In the unlikely event that any of our software fails to load, return your cassette to us and we will immediately send a replacement.

MICRO SOFTWARE

**BBC
MICRO**

★ TOP QUALITY MACHINE-CODE PROGRAMS ★

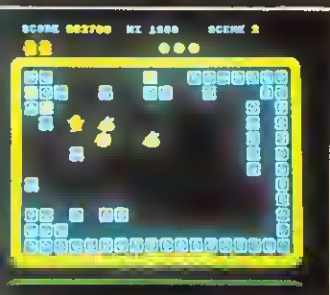
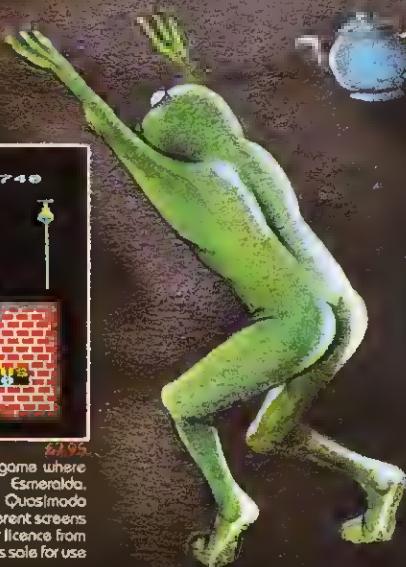
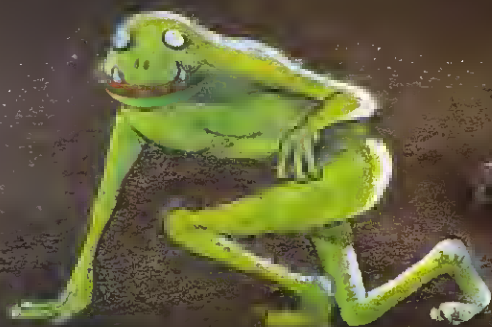

PERCY PENGUIN (38K) £7.95
The best version available for the BBC micro, Percy is trapped in an ice maze which is populated by the deadly Snobees. His only hope of survival is to squash them by hurling ice cubes at them. Unfortunately, whenever it seems that he has won, a deadlier breed appears. Hi-score, rankings, excellent graphics and sound.
(KEYBOARD or JOYSTICKS).
●●●NEW RELEASE●●●



MUNCHNIGHT (38K) £7.95
An excellent version of the arcade game where Quasimodo attempts to rescue Esmeralda. Beautifully detailed animation as Quasimodo leaps over the ramparts. Twelve different screens of action! This program is sold under licence from Ocean; we have exclusive rights to its sale for use on the BBC micro.
(KEYBOARD or JOYSTICKS).
"...an extremely good version of the arcade game...thoroughly recommended"
...BEEBUG MAGAZINE



COSMIC MIDNAP (38K) £7.95
The best version available for the BBC computer. In Cosmic Midnap, you take the role of the Autaguard in charge of your side's three most important alien captives. Suddenly, you hear explosions... your jail is under attack by a fierce swarm of aliens. The game becomes increasingly difficult from screen to screen, and bonus points are scored for hitting the mother ships. A fast-action arcade-style game.
●●●NEW RELEASE●●●



MONKEY PRINTER (38K) £7.95
The only full-feature version available for the BBC micro. On the first screen, you take the part of a monkey being chased by African tribesmen. The bonus screen features the monkey trying to reach his bunch of bananas. After that, you take control of a point-roller and each square pointed-in odds to your score.
(KEYBOARD or JOYSTICKS).
"Great sound and graphics, smooth and accurate animation, responsive and simple controls..."
HOME COMPUTING WEEKLY



ROAD RACER (38K) £7.95
The only full feature machine-code version available for the BBC micro. Features include: scrolling screen, radar display, 3 pursuing cars, checkpoint flags, fuel gauge, smoke screens, 6 skill levels, rankings, increasing difficulty, and sound effects.
(KEYBOARD or JOYSTICKS).
"The game becomes very hard and has very smooth graphics. Excellent..."
BEEBUG MAGAZINE



STAR BATTLE (38K) £7.95
This is a 2-player deep-space dogfight. You each have a limited amount of shield energy to protect you from the other player's laser shots. You can increase your shield energy by collecting the fuel pods dropped by the flying saucer, but your shields will be weakened if you collide with the saucer or the wall snake.
●●●NEW RELEASE●●●

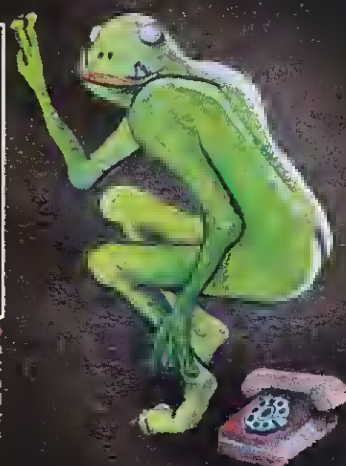

OTHER TITLES AVAILABLE:

OST CITY (Adventure)	£7.95	GNASHER	£6.95	REVERSI	£6.95
STAR TALK ADVENTURE	£7.95	NEUTRON	£6.95	CRIBBAGE	£6.95
GIDEON'S GAMBLE (Adventure)	£7.95	LADDER MAZE	£6.95	PONTOON	£6.95
LODITZ ADVENTURE	£7.95	DRAUGHTS	£6.95		

ELECTRON, COMMODORE-64, AND ORIC PROGRAMS.

DEALERS...DEALERS...DEALERS...DEALERS...DEALERS...DEALERS...DEALERS...DEALERS...

Our software is now available at all good dealers including:
Selected branches of W. H. Smith, Boots, John Menzie's, and Greens of Debenhams.
All major computer dealers - Eltec Computers, Micro Management, West Coast Personal Computers, Microstyle, Electronequip, 3D Computers, Computeramo, GTM Computers, etc.
Our software is also available through all the major distributors, and directly from us by mail-order.

Once you've got

FORTRESS

you might never see the end of it!

Fortress sets the pace for other Micro Games.

Put your skills to the ultimate test and overcome the impossible with this explosive new game from Pace. Meet the challenge and make your mark . . . The fortress awaits you.

Cassette £8.95 inc. VAT. Disc version available, usable on both 40 and 80 track drives. £11.95 inc. VAT.

Available direct from Pace or from your nearest Micro Dealer.

PACE, 92 New Cross Street, Bradford, BD5 8BS.

Access/Barclaycard orders. Tel: (0274) 729306



Please send me 'Fortress' Cassettes at £8.95 inc. VAT + 55p P + P TOTAL £9.50 And/or 'Fortress' Discs at £11.95 inc. VAT + 55p P + P. TOTAL £12.50. Total remittance enclosed.

Access/Barclaycard No..... Cheque/PO No.....

Name..... Address..... Tel.....

BLOW YOUR OWN

Bruce Smith takes out an option on Softlife's EPROM programmer

Softlife EPROM programmer, Softlife, 87 Silvertown Way, London E16 4AH, BBC, £76.90 (inc VAT and p&p)

ON REMOVING the review model from its packaging my first thought was 'well, where's the rest of it?' A quick forage uncovered only the manual and an illustration proving that the item held in my hand was indeed the lot!

The programmer takes the form of a white plastic box measuring just 110 × 65 × 30mm, a bit bigger than a music cassette box. Protruding through the top is the all-important ZIF (Zero Insertion Force) socket into which the EPROM to be programmed (blown) is placed. A single length of ribbon cable passing through the side of the box is the only connection between computer and programmer.

As the Softlife programmer has been designed specifically for use with the Beeb it can accommodate both 8k 2764 and 16k 27128 EPROMs.

Connecting the programmer seemed simple enough, a matter of plugging the ribbon cable into the user port. However, my first efforts at blowing an EPROM proved fruitless and it was only after some head-scratching and then re-reading the connection instructions in the manual carefully that my mistake was revealed. The usual convention for cable connections is that the red coloured side of the ribbon cable is identified as the side adjacent to the triangle silk-screened onto the underside fascia. In this instance, though, the reverse was true. It would have been better if the conventional method had been adhered to. Luckily no harm was done.

The software to run the programmer is supplied on an EPROM, which is loaded into memory by running a short five-line Basic program. Once there it can be saved to disc or tape if so required. Running the program displayed a menu of options as follows:

P(rogram EPROM from a file)
W(rite EPROM to file)
V(erify EPROM against a file)
T(est EPROM is blank)
C(hecksum EPROM)
S(elect EPROM type)
R(OM format)
M(OS call)

Before an EPROM can be programmed its contents have to be saved onto disc or tape. Pressing P sets the ball rolling and you are invited to enter the filename of the file to be placed in the EPROM, which is then loaded in. You are requested to insert an EPROM, which is first tested to ensure it is blank. If it is, programming commences.

Blowing an 8k device takes five minutes and a running count of the time left is given. On completion the EPROM is verified and a checksum value reported for future reference. A 16k chip was



programmed in a similar manner without problems, although I found I had to set Page to a more normal disc level of &1900 from its usual value of &1B00 on my system, to enable the software to load and verify the file correctly without an 'out of room' error occurring. The software also allows you to program, say, a 9k file into a couple of 8k EPROMs.

When you've blown the first EPROM you are prompted to insert the second for programming.

The more technically minded might wonder where the programmer sources the 21 volts required to do the programming. This is drawn from the 5v lines of the user port using an oscillator. Internally the programmer consists of a double-sided printed circuit board containing only a handful of components. Much of the hard work is actually performed by the user port's 6522 VIA chip.

I found the ROM format option the most intriguing. This allows the user to blow

programs into EPROM using the ROM filing system format. Once present in a sideways ROM socket, the program(s) can be loaded simply by entering

```
*ROM
LOAD "Filename"
```

Any number of files in this format may be blown into a single EPROM, the only restriction being that imposed by the memory available in the EPROM itself.

On selecting this option the user is prompted for file names. These are loaded in turn and the appropriate headers added by the software. The EPROM is then programmed.

The ROM format facility offers a cheap alternative to discs, although the amount of memory available for program storage is reduced drastically, and of course you need an EPROM eraser to delete programs from the EPROMs.

The remaining menu options are self-explanatory. The W(rite) option saves the contents of an EPROM in the programmer to tape or disc while V(erify) compares the contents of an EPROM with that of a named file.

T(est EPROM is blank) allows you to ensure that the EPROM you've chosen is empty, but on closer inspection the option is shown to cheat. It checks only the first location in the chip. If this is equal to &FF it assumes the EPROM is empty. This would normally be the case, as a Basic program will always start with &0D (RETURN) and &FF is not a valid opcode in machine code.

Finally, S(elect EPROM type) permits you to choose between 8k and 16k EPROMs, and C(hecksum EPROM) displays the cyclic redundancy checksum of the chip currently situated in the programmer's ZIF socket.

The Softlife EPROM programmer performed exceptionally well. I have now programmed about a dozen EPROMs with it and every one has worked first time. At £76.90 including VAT and p&p it is certainly the cheapest EPROM programmer I've encountered. Its simplicity and compactness make it a highly desirable package for those interested in developing sideways ROM software, and its ROM formatting capability will give it wide appeal. Yes, I'd buy one.

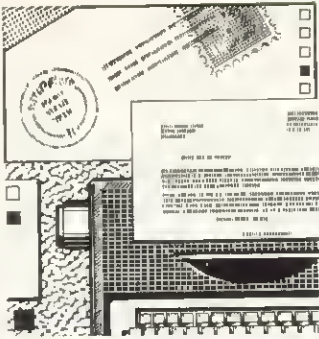

Service for the

legitimate user

Sir, With reference to the letter from Mr Pretorius (April issue, page 169) I would like to present the case from a supplier's point of view. In our case we have experience of both sides of the fence.

The best-selling program in Clares Micro Supplies' catalogue is *Replica II*, which allows the transfer of cassette-based software onto disc. This could obviously have posed great problems due to piracy but from the start we were concerned with protecting other software houses while still providing a good service to the legitimate user. To this end it was decided that the transferred programs would be stored on the program disc and this disc would be protected to prevent copying. This ensures that copies of the transferred programs cannot be passed around. The programs on the disc are useless without the *Replica* programs and these cannot be copied. We have talked to software houses that have been happy with the situation because they have no intention of supplying disc-based software and this is one way of keeping their customers happy. In fact, we now have a scheme that will allow software houses to recover some of the lost revenue on pirated copies of their programs. If any companies are interested in this idea they should contact me on 0606 48511.

Now to the question of corrupted tapes and discs. I think you are being unfair in stating that there are no software houses that provide a prompt exchange of corrupted discs or tapes at a minimal charge. My experience as a purchaser is that most reputable companies will do just that. However, do not expect refunds because it is commercially unsound to let a user have the use of a tape, which he may or may not copy, and then to give a refund. It would be like providing a hire service for the cost of a stamp. Before printing such derogatory statements why not conduct a telephone survey to find out the real situation instead of making guesses. I am sure that one of your very efficient telephonists

could provide a quite accurate picture within an hour. Surely, being correct is the essence of good journalism even if it is not as sensational.

Our own company will provide exchanges of corrupted software, often without charge. Even when the fault lies elsewhere we are always prepared to assist for a minimal charge. *Replica II* is a good example because, due to the fact that programs are stored on the disc, it can become corrupted by various external means. Things such as bugs in DFS chips, incorrect usage or unscrupulous companies that insert routines in their cassette programs which will destroy a disc if the disc filing system is active. The legality of this last action is questionable. While none of the above would have any effect if users followed our instructions correctly we do not abandon them. We will always recopy a disc for a charge of just £1 to cover copying and postage. Even if a user destroys a disc by spilling a cup of coffee on it we will charge only for a replacement blank disc. The same applies to all our disc software, although corruption is very rare in these cases.

I would also point out that responsible companies do provide corrected versions of software found to contain a significant bug and this is a service that we provided recently with our database program, although this was an enhancement and not a bug. Another company with an exemplary record in this area is Pace, which has always provided free upgrades of its DFS. You will notice that I used the term 'upgrade' as this is very different from correcting a bug. An upgrade is an enhancement for which there may be a charge.

The other question that is always raised is that of upgrading from cassette to disc. People who have no idea of how the business operates find it difficult to understand the problems associated with such a service. First, many disc versions of programs are actually enhanced versions of the cassette-based one and as such are essentially different programs. The programs returned for upgrade would present a logistical problem because of the sheer volume. Royalties have to be paid on programs, but how does one calculate the royalty payable on what is probably a loss-making service? As most companies supply by mail and through distributors and dealers it would be impossible to decide which price structure applied to which program. Because of the various discount levels given to distributors and retailers the software house could be faced with a

situation where it has made a very small margin on bulk sales and is then expected to upgrade that program to disc with the net result being a loss. Who will you buy your software off when we are all out of business?

Yet another problem is caused by the useless tapes. They cannot be re-used and they have to be irrevocably destroyed, which again costs money. To incinerate a box of cassettes costs £50 in rural areas and probably more in cities.

If we can get together with software houses there will be no need for such a service because *Replica II* can provide the answer at a reasonable cost to the user and also provide a return to the software house.

D Clare

Clares Micro Supplies
Northwich, Cheshire

Do we need to phone around to get a clear picture when we have had hundreds of complaints from readers? Why, if everything is so rosy, don't software houses even mention in their advertisements the back-up services they give? Do dealers give the same service?

Surely the provision of 'enhancements' has been used to prevent people getting free copies of debugged software. Why doesn't anybody offer a straight debugged version to send free to people who would be happy with that?

Piracy ...

sideways

Sir, With the daily increase in the sophistication of computer technology, it is inevitable that whatever is produced by one manufacturer will ultimately aid the piracy of another manufacturer's product. This 'legal piracy' can be highlighted in many ways, but perhaps the most recent is the introduction of sideways RAM.

The acclaim for its versatility is well founded. Its ability to allow extra program workspace, as well as hold several disc-based ROMs at a time, gives it a definite advantage over sideways ROM

boards, which are prone to such niggling problems as overheating and excessive power drain. However, it must be seen by ROM manufacturers as a threat, particularly as one version comes complete with a ROM copying cartridge to enable the user to transfer his ROMs to disc. What then happens to the redundant ROMs? Most likely they are sold, at a reduced price of course, and the ROM manufacturer has lost yet another sale. The manual? - ever heard of photocopying?

With the availability of many ROM-to-disc copying utilities, the sideways RAM owner can copy any ROM he can lay his hands on, be it from a friend, neighbour or fellow club member. He doesn't even need to remove the ROM from its parent computer, or for that matter, buy or borrow an EPROM programmer. He is totally unaffected by the inflated EPROM prices and doesn't have the capital outlay of a sideways ROM board and up to 16 ROMs at £30+ each. This letter is not aimed at encouraging piracy by promoting sideways RAM, but its advantages cannot be ignored.

Perhaps the only answer is a 'self-destruct' ROM that erases itself when copying is attempted. The loss of a £30+ ROM would coincide with the loss of a friend and a corresponding reduction in piracy. With the advent of EEPROMs (electrically erasable PROMs), produced already by at least 11 firms, this is now quite feasible, particularly as one manufacturer derives the erasing voltage from an 'on chip voltage generator' operating from the normal 5v supply. This precludes the possibility of interrupting the erasing voltage.

While this is not the only answer, it must be worthy of further investigation - so come on all you ROM manufacturers, the ball's in your court. What's your next move to combat this 'legal piracy'?

GA Dubber
Hanls

Several suppliers of software in ROM or EPROM form have already looked into chip protection. Available techniques are too expensive, but Gemini, for instance, has made things difficult by using two EPROMs mounted on a board, with other simple chips.

ASK a silly question, pass a fair comment, stage an angry protest - we don't mind what you write to us about (or about us!). Keep 'em short, keep 'em sweet, but keep 'em coming! The address is: Letters, Acorn User, Redwood Publishing, 68 Long Acre, London WC2E 9JH.

BASIC COMPILER

Turns your Basic programs into really fast machine code. The compiler is very easy to use, and comes complete with full instructions.

For the BBC model B, or model A with 32K.

CASSETTE **£17.95**

DISK **£19.95**
(40 OR 80 TRACK)

CHEQUE/PO. OR SAE FOR DETAILS TO:

ACK DATA

21 SALCOMBE DRIVE, REDHILL,
NOTTINGHAM NG5 8JF
Tel: (0602) 262498

MEMEDIT

This is a very powerful memory viewing and editing utility. A must for all programmers, it can display the contents of memory on the screen (in Hex. and ASCII), search for strings of characters or Hex. bytes, allow editing of memory simply by typing over the contents currently displayed, move blocks of memory (eg. relocate Basic or M/C programs), and much, much more.

For the BBC model B, or model A with 32K.

CASSETTE **£12.95**

DISK **£14.95**
(40 OR 80 TRACK)

ASK ABOUT OUR SOFTWARE AT YOUR LOCAL COMPUTER STORE, OR ORDER DIRECT FROM US.

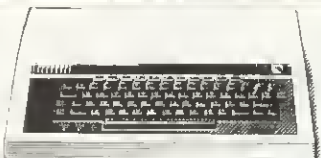
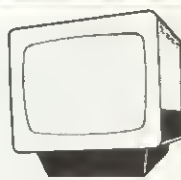
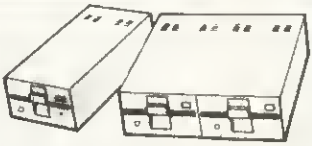
COM-TEC COMPUTER CENTRE LTD		Educational Orders Welcome	
DEALER AND SERVICE CENTRE		Discounts Available on Bulk Orders	
 DEALER AND SERVICE CENTRE 23 Sheffield Rd Barnsley South Yorkshire Tel: 0226 46972		DEALER	
 BBC Model B 399.00 BBC Model B + Disk 469.00 Electron (now in stock) 199.00 Disk Interface Kit 101.00		 BNC Green Screen 113.85 Mitrovitec 14" Cub 245.00 Phoenix Green Screen 130.00 BBC Monitor 99.00 Amber Screen 135.00	
PRINTERS Seikosha GP50A 138.00 Seikosha GP50S 138.00 Seikosha GP500A 228.85 Seikosha GP550A 299.00 Seikosha GP700A 458.00 Seikosha GP250X 264.00 Friction Feed GP100/250 28.00 Epson RX80 310.00 Epson RX30FT 350.00 Epson FX80FT 431.00 Star Gemini 10 x 280.00 Star Gemini 15 x 400.00		 SD Single Drive DD Dual Drive 207.00 SS Single Sided DS Double Sided 253.00 SD SS 40tk 100k 228.00 SD SS 30tk 200k 287.00 SD DS 40tk 200k 431.00 SD DS 80tk 400k 511.00 DD DS 40tk 400k 310.00 DD DS 80tk 800k 534.00 SD DS 40/80 534.00	
4 Colour Plotter + BBClead 129.95		DISCS (Scotch 3m) 744 SS40 19.32 745 DS40 27.95 746 SS96 34.50 747 DS96 46.25 7440 Clean kit 19.50	
RIBBONS Seikosha 4.99 Epson £5.74		ROMS Wordwise 45.00 Disc Doctor 33.00 Graphics Ext 33.00 Print Master 33.00 Caretaker 33.00 AOE 60.00 Spyl 30.00	
		SOFTWARE Felix in Factory 7.95 Martian Attack 7.95 Cybertron Miss 7.95 Hell Driver 7.95 Moon Raider 7.95 Alien Swirl 7.95 Laser Cmd 6.95 Danger UXB 7.95 Escape Mibs 7.95 Galactic Cmd 7.95 Labryn Lacush 7.95 Dambusters 7.95 Lunar Rescue 7.95 Gideons 7.95 Gamble 7.95 Swoop 7.95 Carn 7.95 Chess 7.95 Physics 6.95 Where 6.95 World Geog 6.95 Adventure 7.95 Caveman Ad 6.95 Fairground 7.95 Crazy Painter 7.95 Lost City 7.95 Monaco 7.95 Flexibase 9.95 Alligatacalc 9.95	
		Order 1: deduct £1.00 Order 2: deduct £3.00 Order 3: deduct £6.00 Order more than 3, deduct £2.00 per game.	
		CARRIAGE FREE ON ALL ITEMS	
		Access and Barclaycards accepted Tel: 0229 46972	
All drives include leads, manual and utility disk Torch Disk Pack 839.00			

20 69 74 20 77 69 60 t it wil
 20 62 65 20 74 68 65 i be the
 60 61 73 74 20 66 6F last to
 20 73 6F 6D 65 20 6D r some -
 6F 6E 73 69 64 65 72 consider
 62 60 65 20 70 65 72 able per
 6F 64 20 2E 20 49 66 iou . It
 79 6F 75 20 70 69 72 you pir
 74 65 64 20 74 68 69 ated thi
 00 73 6F 66 74 77 61 s softwa
 65 20 74 68 65 6E 20 re then
 6F 75 20 70 72 6F 62 you prob
 62 65 79 20 68 61 76 ably hav
 20 61 60 72 65 61 64 e ahead
 20 70 69 72 61 74 65 v pirate
 20 74 68 65 20 57 61 d the wa
 66 6F 72 64 20 2L 20 thord ,
 65 73 74 20 69 6E 20 best in
 68 65 20 77 6F 72 60 the worl
 20 2L 20 44 46 53 20 d , DFB
 6E 64 20 61 72 65 20 and are
 69 72 65 63 74 65 64 directed
 74 6F 20 72 65 61 64 to read
 74 68 65 20 60 61 72 the las
 20 66 65 77 20 70 61 t few pa
 63 73 20 6F 66 20 74 ges of t
 69 73 20 6D 61 73 74 his mast
 72 66 75 6E 20 77 6F erful wo
 68 2E 20 41 60 60 20 ek. All
 74 20 57 61 74 66 6F al Watfo
 64 20 68 61 74 65 20 rd hate
 6F 75 20 70 65 72 73 you pers
 66 61 60 60 79 20 61 onally a
 64 20 77 6F 75 60 64 nd would
 64 66 61 72 60 79 20 dearly
 6F 76 65 20 74 61 20 love to
 65 65 20 79 6F 75 20 see you
 69 65 2L 20 6E 6F 74 die, not
 6F 75 74 20 6F 66 20 out of
 6E 79 20 6D 61 60 69 any mail
 65 20 60 73 69 60 70 ce, stamp
 69 20 72 6F 20 74 68 ly so th
 74 20 77 65 20 63 61 at we ca
 20 63 6F 60 65 70 61 n come a
 64 20 73 70 69 74 20 nd spat
 6E 20 79 6F 75 72 20 on your
 72 61 76 64 2E 6D 6F grave. I
 56 20 47 40 50 61 4 FFF DMPPE
 20 74 49 44 55 49 46 Z 11JUE
 45 20 55 49 46 46 47 BE DUEB
 70 20 29 20 20 20 20
 00 00 00 00 00 00 00
 00 00 00 00 00 00 00
 00 00 00 00 00 00 00
 00 00 00 00 00 00 00
 00 00 00 00 00 00 00
 00 00 00 00 00 00 00

Pirates' club

The following letter was forwarded by Microdeal, whose correspondent, writing from Eire, gave his full name and address but asked to remain anonymous.

Sir, Until recently I had no feelings either way towards software piracy, but copying a tape for a friend did not seem too bad considering that the average cost of a Dragon game was about £8. However, I am now appalled at mass software piracy and this is why I am writing to you.

A Dragon 32 users group has recently been set up in Belfast. It charges no entrance fee and does not call itself a club. But, you ask, if it doesn't charge an entrance fee, how can it cover its cost and turn a profit? The answer is simple: software piracy.

The group is open to anyone and is a mail order type one. Each member receives a list of available software and their prices. Software comes from your company [ie, Microdeal], Salamander, Dragon, DACC and others. The last list that I saw showed that all your software was available. Your £8 programs were available for £1 and Tele-Writer was available for £10.

The duplicating was a very professional job as far as I could see. Tape was spliced to the correct length and all the tape cassettes were of the same make. The instructions were either handwritten or computer printed. In the case of DACC's *Flight Simulator*, which has long and complicated instructions, they were photocopied.

I sincerely hope you will stop this operation and inform the other companies involved. I got the information from the documents sent to members (a friend of mine is one) and, believe it or not, from a computer magazine. I don't know the UK's copyright laws very well but I assume they are sufficient to frighten such groups into closing.

Bugbeaters

Sir, I feel drawn to comment on Rod Borland's letter (February issue). I exist only to serve his second type of user - those who use a microcomputer as a reliable tool. I debug programs which refuse to work, and help users plan their own. I also deal with magazine or book listings, which have a high rate of inaccuracy, and which can cause confusion with the use of graphic characters, as on the Spectrum.

I have advised on package

facilities because documentation has been inadequate, and even solved a problem by suggesting that the Record button needs pressing on a tape recorder when saving a program!

So if any of your readers are in a similar position to Mr Borland, please try me first. Incidentally, we must be on the same wavelength, as I have called my advice service the very word you used in describing Mr Borland's letter - Bugbear!

Frances Daniel
 42 Brookside Avenue,
 Kenilworth, Warks

Northern lights

Sir, We would like to inform you of the existence of our Swedish BBC users group, BUG. The group was formed in October 1983 and we publish a monthly newsletter. Another service for the members is our own database devoted entirely to the BBC, although it is possible to make connection with other computers.

The transmission speed is 300 baud.

We very much want British BBC users with modems to call us. The telephone number is (0) 8-463528.

With the database it is possible to send electronic mail, download software, play games and lots more.

Anders Wickman
 Folkungagatan 58
 11622 Stockholm

Help the aged

Sir, I am an occupational therapist currently working with elderly patients. We have recently acquired a BBC micro, but we are faced with the problem of finding 'suitable' software for these patients. We need programs that are:

- Appropriate to the elderly age group (no childish graphics, nursery rhymes, etc)
- Educational
- Large print
- Not too much information on the screen at one time
- Colourful
- Not requiring the use of too many keys on the keyboard
- Any using Concept keyboard if possible

Should anyone reading this be able to help us with programs, information, advice, contacts, etc, we would be most grateful.

Karin Treial
 Hackney Hospital
 Homerton High Street
 London, E9

Tel: 01-985 5555, Ext 46 or 14

Testing VDUs

in the field

Sir, With reference to George Hill's monitor reviews in the April *Acorn User*, I found the programs useful as I was about to buy a monitor. I joined the two programs together with an A\$=GET\$ line between them so that one would run after the other, and took a copy with me to a show.

There are three levels of slot pitch of a tube, a colour TV being the basic. The SP of each monitor is marked, as manufacturers do not use a common basis.

I tried the program out on every monitor I could, including the two models of JVC (medium and high resolution) on the Opus stand, both the medium and high resolution Hantarex monitors, the low, medium and high resolution Microvitec monitors, and a Philips monitor/TV. (I used ten different Microvitec sets.)

Using the stripes program, I found the resolution and clarity of the Hantarex medium was OK, and the high excellent, but both were spoilt by very poor alignment, the picture was out of square, went off the screen at both the top and bottom, the sides of the picture were slightly curved and the colour guns were set wrong, giving colour fringes to everything. The JVC medium was poor, the JVC high-resolution set was about the same as the Hantarex medium, but the colour guns were again set wrong, though not as bad as the Hantarex, and the picture curved very badly on all four sides. The Microvitec low was the same as most TV/monitors, the medium and high resolutions were both excellent in every way, with the right amount of gap at the top, bottom and sides of the screen, straight on all sides, no colour fringing, and a good white. The Philips monitor/TV was found to be better than both the Microvitec low resolution, and the JVC medium resolution. These opinions were shared by others who watched the tests.

I was all set after reading the test by Mr Hill to buy a JVC high resolution monitor but after the tests I conducted, of which the stripe program was an important one, I purchased a Microvitec Cub medium resolution model 1451/MS4, which has the advantage of a screen which absorbs some light rather than reflect it all. I have used this monitor for periods of up to ten hours and found all eyestrain has gone and I feel much fresher when I have finished.

I would suggest to Mr Hill that

Greetings from Watford

Grave message

Sir, I recently started taking your magazine and have followed with interest the exchanges of letters to, from and about Watford Electronics.

Today I was playing with my latest toy and found that Watford's ROM contained considerably more than a screen dump routine. The attached printout (above) is self-explanatory.

You will not find it surprising, I am sure, that I resent paying £19.09 to have a message like this installed in my purchase when I am, like most, a bona fide, paying, customer.

R M Pothecary
 Surrey

A J SOFTWARE for BBC



'The Record Changer'

32K £19.95 Cass. £24.95 Disc.

for indexing, membership lists, directories, inventories, budgeting, etc, etc.

don't buy a database in the dark —
check the spec!

'The Wordsmith' 32K for Centronics 737/739

AND NOW FOR EPSON FX80:

£19.95 Cass. £24.95 Disc.

Options Timetable 32K

£14.95 Cass. £19.95 Disc.

Simple Word Processor 32K

£9.95 Cass. £14.95 Disc.

Picture Maths

£9.95 Cass. £12.95 Disc.

An arithmetic practice program for primary schools.

Character Definer £9.95 Cass.

Enlarge, reduce, etc, etc.

Tape Catalogue £5.95 Cass.

Catalogue all your tapes using this program and never lose one again

Copy Disc £9.95

Copy disc to tape, tape to disc, M/C, Data or Basic.

ROM Read

£8.95 Cass. £11.95 Disc.

A machine code program to read the contents of any ROM socket and copy to RAM, tape or disc. Not to be used for illegal copying.

Machine code Disassembler

£5.95 Cass. £7.95 Disc.

Open Evening Timetable 32K

£14.95 Cass. £19.95 Disc.

Utility Eprom £19.95

for basic programmers

Mitsubishi Disc Drives

Dual 80 Track 800K £380 + VAT

Single Track Drives

Dual Sided 200K £199 + VAT

Double Density Disc Interface £80 + VAT

The best there is.

Epson Printers

FX80 £370 + VAT

RX80 £270 + VAT £8.00 Carr

BBC Epson Cable £15 + VAT

Normende

Not only the cheapest, but the best

Switchable 14" RGB Monitor/Colour TV £250 inc. VAT and cable, £8.00 carr.

Royalties for quality software

All prices VAT inclusive except where shown

AJ Vision Service Ltd, 61 Jeddo Road

London W12 9ED

NEWARK VIDEO CENTRE
PRESENTS

SUPER CLEAR COMPUTER DISPLAY - AND A TV!!

AN RGB MONITOR - WITH TV RECEPTION

14" C2402/RGB £275.00 - 20" C6100/RGB £365.00
16" C3104/RGB £299.00 - 22" C7100/RGB £399.00
16" C3040/RGB with Remote Control (Teletext Extra) £355.00
26" C8400/RGB with Remote Control (Teletext Extra) £465.00

**All prices include VAT, a 12 month
guarantee, a 6 Pin Din lead, a mains plug and
carriage to your door. All are Grundig TV's supplied
with Grundigs consent.
Educational and quantity discounts are available.**

What 'What Micro' said:

'The colours are just unreal like
the 'simulated' pictures in TV
advertisements. The best of all
images came from this set'

'A very reasonable comparison
could be made with colour
monitors costing several
hundreds of pounds'

For details of the full range contact:

NEWARK VIDEO CENTRE LTD

108 LONDON ROAD, BALDERTON,
NEWARK, NOTTS. NG24 3AQ.
TELEPHONE: 0636 71475

Open 9 am - 6 pm Monday - Saturday

Access and Visa cards accepted



QUALITY EDUCATIONAL SOFTWARE

PLAYBOX

BBC MICRO B/ACORN ELECTRON

A series of three programs that will provide hours of fun for all the family.

MEMORY is a game for two players, where the computer displays a series of pictures which must be paired off.

HANGMAN has a vocabulary of 280 words and a facility to define your own words. Categories include countries, animals, birds, world capitals and others, for age seven upwards.

BRICKSMASH traps you behind a red brick wall. Answer the general knowledge questions correctly to break down the wall and escape.

All programs are very user-friendly with full colour graphics and high quality sound. All three programs are available on one cassette for £6.50 incl. Also available on 40 Track disc for £8.50.

AVAILABLE BY MAIL ORDER OR FROM GOOD COMPUTER OUTLETS.

PLEASE STATE WHICH COMPUTER WHEN ORDERING.

COMSOFT COMPUTER SOFTWARE
7 ROMAN DRIVE
LEEDS
WEST YORKSHIRE

GUARANTEED
48 HR DESPATCH

TRADE ENQUIRIES WELCOME. TEL 0532 665621

before concluding a test he checks the specification of the sets and compare like with like, as from what I can find out most school monitors are the low-resolution type.

R C Luxton
Gwent

A valid point, and thanks for your comments. We hope the detail in this issue's monitor reviews (page 134) is more to your liking. We're glad to see readers going out and using the programs like this - it's exactly what we print them for.

Adjustable

Electrohome

Sir, In George Hill's review of monitors he claimed that his high-resolution Electrohome was not adjustable except for brightness. My medium-resolution version of this monitor has several adjustments which can be made with a small screwdriver through a grid at the rear, as instructed by the manufacturers. One of these is a vertical height adjustment. By slightly compressing the screen on the monitor, losing only about 0.5cm at the bottom, the top line on my Electron becomes completely visible.

Since the Electron does not respond to the Beeb's *TV255, I this may be a great boon to Electron owners. Possibly other monitors have the same facility?

R Harper
Dunstable, Beds

Mystery of PL4

Sir, I wonder if you could explain what purpose PL4 serves on the Atom. I presume it will provide sufficient information to drive a colour monitor, but I have never been able to have this confirmed. If this is not so, who now provides colour encoder cards for UHF output? I am having difficulty finding stockists.

Nigel Harper
North Humberside

Barry Pickles writes: PL4 provides the necessary signals (from the 6847 VDG) to interface to an NTSC modulator. To use this on British TVs/monitors additional circuitry is required. Acorn User (October 82) described the construction of an RGB monitor interface but a colour encoder is needed if you wish to use a TV set. As you say, these are hard to come by, but I can recommend the one from Ampersand Computers - this will be reviewed shortly. It is supplied in various forms, but you may buy

a ready-built one for £21.50. Ampersand's address is: 86 Neat Road, West Kingsdown, Sevenoaks TN15 6DQ.

Disc standard

Sir, The majority of advertisements in *Acorn User* for disc drives refer to the 5 $\frac{1}{4}$ in size, the 3in models being only recently introduced and as yet not as popular. Drives of 8in size do not appear to be available on the personal computer market and seem to be utilised mainly by industrial users.

The magazine *Electronic Engineering* of October 1983 referred to the setting up of the Microfloppy Industry Committee in May 1982 with the objective of uniting manufacturers to a single standard system. The system being supported is a 3 $\frac{1}{2}$ in microfloppy, the Shugart SA300 being such a model referred to.

With so many manufacturers marketing so many sizes could you confirm whether any standard is being introduced for disc drives? I am contemplating purchasing a drive for the BBC computer, and do not wish to purchase a system that may be obsolete in a few years' time.

G Cooke
Merseyside

The committee you refer to was set up in the US, with just four members, and little has been heard since. The standard was suggested by Shugart itself.

The electronics and comput-

ing fields are renowned for trying to produce - or even actually passing - standards.

Video is the most obvious example, but interfacing is a classic in computing with Centronics, RS423, RS232C, IEEE all enjoying the 'standard' label. The problem is that everyone goes off and 'interprets' the standard in different ways, or implements just part of it. Then you get some of the big companies producing their own interfaces to make it difficult for others to produce 'compatibles'.

There seems little chance of any microfloppy standard because, just like the video industry, the industry is split - and companies such as Sony and Hitachi aren't going to settle on Shugart's system.

Even if a standard is set, only in industries where international protocols really matter - such as communications - will it be kept.

One old hand in computing was once asked which would become the standard, 3in or 3 $\frac{1}{2}$ in. His answer was: 'Oh, definitely 3in. Why was he so sure? 'Because it fits in my shirt pocket'.

Dating game

Sir, What a clever innovation by your new publishers! The idea of leaving blank pages (April issue, pages 107-108) for readers to insert their own programs is an

```

10MODE7
20PRINT TAB(11,3);CHR$(141);"DATE OF
EASTER"
30PRINT TAB(11,4);CHR$(141);"DATE OF
EASTER"
40 PRINT "Using an algorithm due to
T. H. O'Beirne - see 'Puzzles and Parad-
oxes', Oxford University Press, 1965, c-
hapter 10, pp168-184. 'Ten divisions le-
ad to Easter.'"
50PRINT "Year (Gregorian calendar)?"
60INPUT X%
70PRINT "Date of Easter Sunday is:"
110A%=X% MOD 19
120B%=X% DIV 100;C%=X% MOD 100
130D%=B% DIV 4;E%=B% MOD 4
140 G%=(8*B%+13) DIV 25
150H%=(19*A%+B%-D%-G%+15) MOD 30
160M%=(A%+11*H%) DIV 319
170I%=(C% DIV 4+K%+C% MOD 4
180L%=(2*E%+2*I%-K%-H%+M%+32) MOD 7
190N%=(H%-M%+L%+90) DIV 25
200P%=(H%-H%+L%+N%+19) MOD 32
210IF N%=3 THEN PRINT TAB(5);"March
"; ELSE PRINT TAB(5);"April ";
220PRINT P%
230PRINT "Another year?"
240IF GET$="Y" THEN RUN
250END

```

G J Suggett's alternative to Paul Caswell's date-finder, published last month.

excellent one!

Enclosed is my own Date of Easter program which uses a neat algorithm due to T H O'Beirne.

G J Suggett
Chichester

Smoother ADC

Sir, I would like to compliment Paul Beverley on his excellent article about the BBC's analogue-to-digital converter chip (March issue). We are using a BBC micro as a 'data station' between scientific instruments and an intelligent plotter and were always a little disappointed at the 'shakiness' of the plotter printout. Needless to say, Paul Beverley's article held the answer.

However, perhaps because we have the Watford DFS we were unable to load Paul Beverley's program at his start address &C00. In any case, we have user defined characters in our programs which would have been overwritten by the averaging routine. I realise it is of no consolation to cassette users, but we are able to load this routine at &900, changing line 20 of the averaging routine program accordingly. Our plots on the screen and on the plotter are now a lot smoother - thank you.

Dr Alex F Drake
King's College, London

Raid cheat

Sir, with reference to high scores. The highest scores achieved at my school to date are:

Snapper - 116,320
Snapper (joystick) - 143,420
Dare Devil Dennis - 6520
Meteors - 21,250
Monsters - 38,680
Zalaga - 132,260
Rocket Raid - 700,000+
Arcadians - 28,760
Defender - 356,775
Planetoid - 236,100
Starship Command - 1376
Moon Raiders - 285,580
Killer Gorilla - 496,200

One interesting score is the *Rocket Raid* one - this is achieved by 'cheating' thus:

- PAGE = &E00: *TAPE
- CHAIN "" (load *Rocket Raid*)
- When the game has loaded press BREAK
- Type CALL &E00 and press Return
- Destroy all 3 ships - the screen will go haywire
- Wait approximately 3 minutes
- Play game
- You now have about 70 men before step 6 repeats.

N.B. The score is reset on pressing ESCAPE.

B Nesbit
Northants

NOW AVAILABLE
FROM W.H. SMITH

A DOUBLE-SIDED 3" DISC DRIVE AT A SINGULAR PRICE.

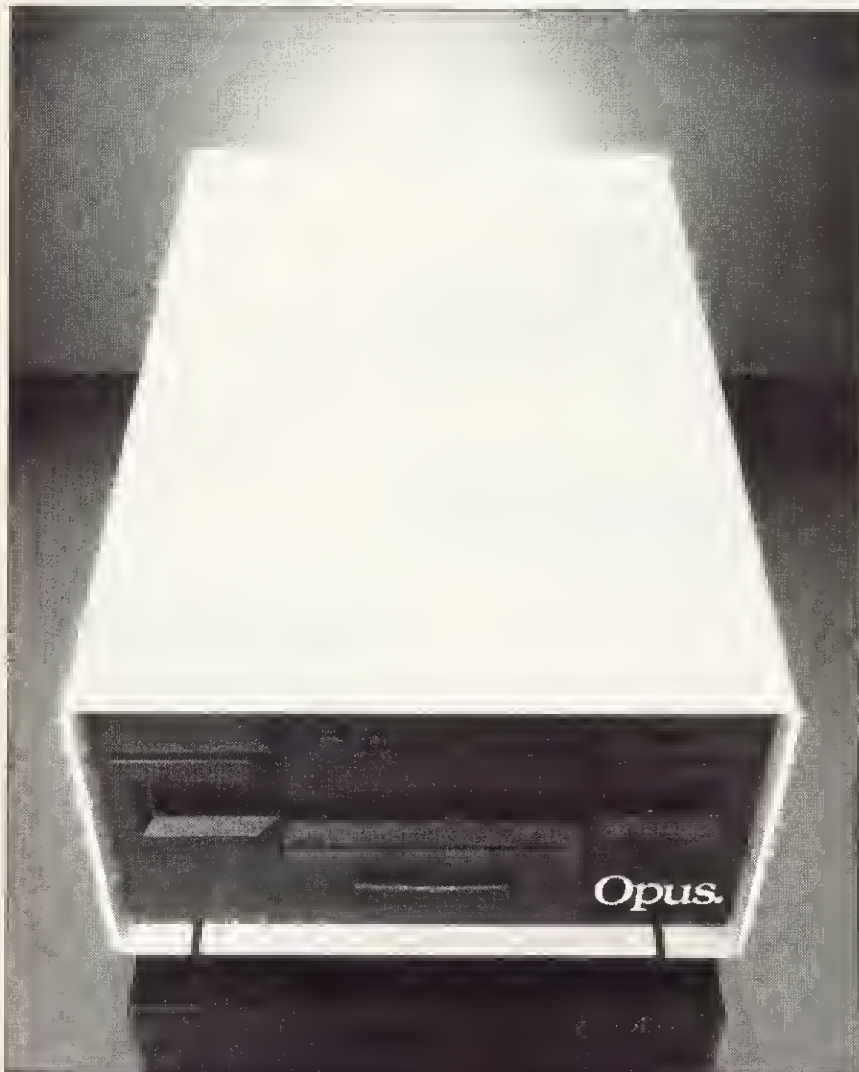

THE OPUS
SUPER 3 MICRODRIVE.

£229.95 (INC. VAT)

FOR USE WITH YOUR BBC MICRO.

For only £229.95 (and that includes VAT, and all the necessary leads) you can have an OPUS 500k double-sided disc drive. And remember 3" disc drives are fast becoming the standard for home and business use.

This is an even bigger bargain than it sounds. For you're getting a double sided drive at the price that other company's sell single sided drives for. It reads and writes to the disc cartridge from both sides, giving you twice the on-line capability of other 3" drives. And there's no need to flip the disc over!

STATE OF THE ART TECHNOLOGY FEATURING:

- Easy to connect to the BBC Micro
- Compatible with most other makes
- Comprehensive manual
- Free disc cartridge
- Format, verify and other utilities provided
- Direct Drive
- Double sided
- One touch cartridge load
- 3 ms access time
- Portable, compact and reliable
- One year's full guarantee
- Totally compatible with 5 1/4 drives

TECHNICAL PERFORMANCE.

	Single Density	Double Density
Capacity	250K Bytes	500K Bytes
Recording density	1,915 BPI	9,840 BPI
Track density	100 TPI	100 TPI
Total number of tracks	10 (each side)	10 (each side)
Recording method	FM	MEM
Rotational speed	300 RPM	300 RPM
Transfer rate	125K Bits/Sec	250K Bits/Sec
Access time track to track	3 ms	3 ms
Access time settling	20 ms	20 ms
Motor start time	0.5 sec	0.5 sec

The Opus Super 3 Microdrive is now available from W.H. Smith's and leading specialist shops.

Dual disc drives are also available for £460.

OPUS SUPPLIES LTD.

158 Canberwell Road, London SE5 0EE.
Opening hours: 9.00-6.00 Monday-Friday, 9.00-1.30p.m. Saturday. ☎ 01-701 8668 01-705 6155

To: Opus Supplies Ltd., 158 Canberwell Road, London SE5 0EE. Please rush me the following (ALL PRICES INCLUDE VAT & CARRIAGE.)

Quantity	Description	Price
	Single drives (U.K.) £229.95 ea	
	Dual drives (U.K.) £459.95 ea	
		101M

Enclose a cheque for £
Or please debit my credit card account with the amount of £ AU17
My Access/Barelaye card (please tick) No is _____

Name _____
Address _____

Telephone _____

Opus.
Opus Supplies Ltd.

BBC NEWS FROM DP

- Case to hold one drive
- Ribbon cable to connect one drive to BBC Micro
- Power cable to power one drive from BBC Micro
- Switch on rear of case to select 40 or 80 TPI operation when using FD55E or FD55F.



BBC COMPATIBLE FLOPPY DISC SYSTEMS AND DRIVES

- CASE to hold two drives (complete with blanking panel for use should only one drive be installed).
- Ribbon cable to connect **two** drives to B.B.C. Micro.
- Integral power supply for **two** drives.
- Switch on rear of case to select 40 or 80 TPI operation when using FD55E or FD55F.

TEAC FD55 SERIES 5.25" 1/2 HEIGHT SLIM-LINE DISC DRIVES.

	Capacity	40TPI	80TPI	
FD55A 40 Track, Single Sided.	100K	N/A		£130
FD55B 40 Track, Double Sided.	200K	N/A		£180
FD55E 40 or 80 Track, Single Sided.	100K	200K		£155
FD55F 40 to 80 Track, Double Sided.	200K	400K		£218

THIS CASE CONTAINS ALL HARDWARE NECESSARY FOR TWO DRIVES. JUST SELECT ONE OR TWO DRIVES FROM THOSE SHOWN BELOW. IF YOU SELECT JUST ONE NOW, THE SECOND CAN JUST PLUG IN LATER. CASES ONLY SOLD WITH DRIVES.

HANDBOOK AND FORMATTING DISC

£15

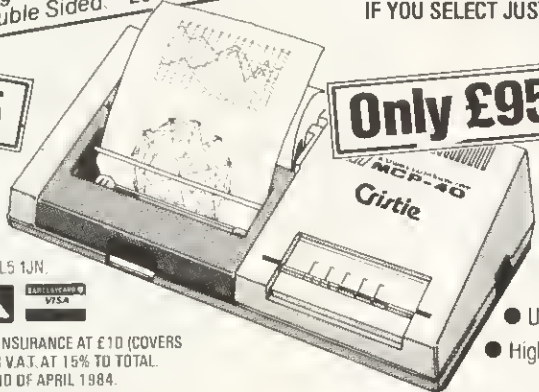

Only £95

PRINTER AND PLOTTER —MCP 40

- 4 colours
- Selectable 40 or 80 characters per line
- Easy to use—simple software commands
- Standard Centronics interface—cables available for most micros
- Uses 4 1/2" plain paper
- High resolution—over 100 steps/inch

ALL EX-STOCK

DELIVERY: Up to 28 days
WARRANTY: 90 days
TERMS: Strictly cheque with order
 Send to P.O. Box 11, Stroud, Glos. UK GL5 1JN
 or phone through your
 Access or Barclay Card number

TO ORDER: ADD CARRIAGE/PACKING/INSURANCE AT £10 (COVERS NEXT DAY SECURICOR DELIVERY). THEN V.A.T. AT 15% TO TOTAL. THE ABOVE PRICES ARE VALID UNTIL END OF APRIL 1984.

DIGITAL PERIPHERALS LTD. Rodney House, Church Street, Stroud, Glos. U.K. GL5 1JN
 Tel: (04536) 71387. Telex 43551.

Cristie Company

BOX CLEVER



All available for BBC and Electron
 Price £6.95 each.

Selected titles available from larger branches of **Boots** Greens, Rumbelows and all good computer shops or mail order from

Cases Computer Simulations Ltd., 14 Langton Way, London SE3 7TL.

Strategy Games. They're no pushover.

The Data Store

6 CHATTERTON ROAD
BROMLEY
KENT

for the BBC MICRO
OFFICIAL ACORN DEALERS

WIDE SELECTION OF SOFTWARE
AND PERIPHERAL EQUIPMENT
INCLUDING

EPSON, NEC, SEIKOSHA
PRINTERS

ZENITH, CABEL
MONITORS

CUMANA
DISC-DRIVES

BOOKS AND CABLES AVAILABLE
plus our personal advice service

MACHINES DELIVERED & SET UP
IN YOUR HOME

PHONE 01 460 8991 (9.30 - 5.30)
ORPINGTON 26698 (Evenings)
(CLOSED WEDNESDAY)

BBC MICRO REPAIRS by MICROFIX

ACORN AUTHORISED SERVICE CENTRE

We will repair your faulty BBC micro,
disc drive or monitor quickly and at
a reasonable charge. Most repairs
cost between £10 and £20.
We can also offer extended warranties
on all your equipment.
Send S.A.E. for full price list.

Phone 01-968 9214

or call in at

191 Freston Road,
(Latimer Road Tube)
London W10

and ask for Mark Duffill or Derek Mullings.

PAYROLL

FOR THE BBC B

For up to 150 employees.
Designed for dual 40 track disc
using Random Access Operation.

CALCULATES Most tax codes.
Up to 18 N.I. rates.
Tax return information,
24 fixed or percentage deductions,
employer's and employee's pensions.

PRINTS Payslips, cheque, bank list,
Coin and note analysis,
Departmental accounts,
Employee's file.

INCLUDES Pass word, user changeable,
Master file, user changeable,
This holds all the tax rates,
Limits N.I. rates, etc.
Technical backup and notification of
any changes in Payroll procedures.
And many other features.

Price is £49.95 inc VAT, plus 50p p & p from
us or from selective computer shops.

Send orders to:-
C.Y.B. Design Services Ltd.,
8, Briar Avenue,
Norbury, London,
S.W.16 3AA.

Tel 01-764-5994

Also available BBC B disc Mailing List £19.95.

Trade enquiries welcome.

VICTOR MORRIS Glasgow

Authorised
acorn  dealer

B.B.C. B & acorn
electron

Disk Drives, Printers, Joysticks,
Acornsoft, Data Recorders, Monitors,
Add ons by Pace, Torch etc.

spectrum Group Dealer

Acorn, Visi, Amex, Dman

340 Argyle Street

Between Central Station and Anderson Bus Station

Glasgow G2

Tel: 041-221 8958

Disc Doctor

DISC DOCTOR is a general purpose utility ROM which adds 20 new commands to the BBC Micro. Most of these are concerned with disc operation although some of the commands are general purpose.

The extensive range of disc commands include a disc search routine and a very easy to use sector editor which allows any sector to be examined and changed if necessary. The built-in formatting command has a special option allowing dual catalogues on each side of the disc, so that up to 60 files per side may be used - almost twice the normal limit.

*RECOVER and *RESTORE commands are provided to help in the restoration of deleted or partially corrupted files. Any area of the disc may be transferred to memory, altered and *SAVED or *RESTORED back onto the disc. These commands prove invaluable when hours or even days of work are accidentally lost.

Many disc users often encounter the frustration of programs originally designed for use on cassette and require relocating to operate on disc. Disc Doctor provides commands to help with the transfer. *TAPEDISC and *DISCTAPE provide a simple means for automatically transferring non-protected files between tape and disc. Once programs are on disc, there are several relocation functions available. *MOVE will move a program from one page in memory to any other. *DOWNLOAD will load the program from disc and automatically move it to a specified position. *MENU is more comprehensive still, offering a menu of programs available and allowing single key press selection of any one. The chosen program is then loaded, re-located if necessary and automatically executed, whether BASIC or machine code.

General purpose commands include: *DIS - which will disassemble an area of memory, following or skipping jumps, adding an offset, disassembling an instruction at a time or disassembling continuously.

*MSEARCH - to quickly locate any string of bytes in memory, specified either as a character string, numeric values of a mixture of both.

*MZAP - a very easy to use memory editor, allowing the user to scroll quickly up/down memory. It can be called from other programs to examine memory, then return to the program.

*EDIT - will list any or all of the function key definitions, so that the user may edit and copy them.

The DISC DOCTOR ROM contains a full help menu listing all the commands and their syntax for quick reference. A spiral-bound manual gives general information about discs and describes each of the commands in detail, with examples. Easy-to-follow fitting instructions are supplied, allowing the ROM to be easily fitted by even the inexperienced user.

```
DISC DOCTOR 1.09
DIS (<sta>){<end>}(<ofs>)
DISCTAPE <altp> (<altp>)
DOWNLOAD <fsp> (<adr>)
DSEARCH <str> (<trk> (<trk> <sect> <drv>))
DZAP (<trk>){<trk> <sect> <drv>}
EDIT (<key no.>)
FIND <str>
FORM <drv> <no. trks> (<stt>)(<S>)
JOIN <fsp> <altp> (<altp>)
MENU (<drv>)
MOVE (<dest page>){<src page>}
MSEARCH <str> (<adr>)
MZAP (<adr>)
PARTLOAD <fsp> <ofs> <ext> <adr>
RECOVER <trk> <sect> <sect> <adr> <drv>
RESTORE <trk> <sect> <sect> <adr> <drv>
SHIFT <arc> <dest> <ext>
SWAP (<drv>)
TAPEDISC (<fsp>)
VERIFY (<drv>){<no. trks>}{<stt>}
```

Easy to Fit



£33.35 incl.

Graphics ROM

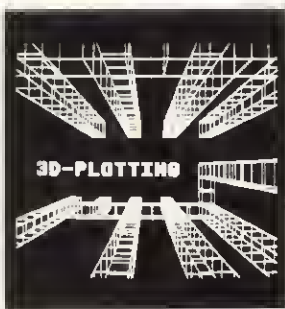

The GRAPHICS EXTENSION ROM brings 30 new powerful graphics commands to the BBC machine. The commands may be typed immediately or included within programs written in BASIC, BCPL, FORTH, etc. The commands act quickly (being machine code) and are always available without taking large amounts of program memory. The commands can be split into three categories:

1. Sprite Graphics

A sprite is similar to a user-defined character, except that sprites may be multi-coloured, several times larger (8x8 to 24x24 pixels in size), they are easily defined and altered with in-built commands and may be saved and later loaded. Sprites may be displayed and quickly moved around. Up to 32 different sprites may exist at the same time. 'Films' may also be created, in which any sprite is treated as a single 'frame'. Each time the 'film' is used the next 'frame' in sequence is automatically displayed, allowing simple animation of sprites. Any number of the possible 32 sprite numbers can be defined instead as a 'film' which may include a list of up to 47 'frames' in any order.

2. LOGO 'Turtle' Graphics

By using simple FORWARD, BACKWARD, LEFT and RIGHT commands a 'turtle' can be moved very quickly around the screen, producing intricate patterns by the most user-friendly means. The commands may be included in structured BBC BASIC programs providing a system faster and more powerful than many of the packages currently used to demonstrate LOGO turtle graphics.



3. General purpose commands

- * FILL will fill an intricate shape.
- * CIRCLE provides fast and easy circle drawing.
- * ARC fast easy arc drawing.
- * PLOT provides 3D graphics drawing by plotting with X, Y, and Z co-ordinates.
- * SCALE allows a scaling factor to be applied to everything subsequently plotted.
- * ROTATE applies a rotation upon all subsequent standard PLOT, DRAW and MOVE commands so that they are rotated around any origin.

A built-in help menu showing the syntax of all commands is provided for quick reference. Included in the package is a comprehensive spiral-bound manual and step-by-step fitting instructions, suitable even for the inexperienced.

Further details available upon request.



£33.35 incl.

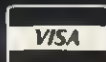



DO YOU WANT A WORD PROCESSOR FOR YOUR BBC OR A WORD PROCESSOR FOR YOUR BBC ?

Yes there is a difference between word processors and we can offer the best because it's the FIRST PROFESSIONAL DISC BASED WORD PROCESSOR FOR THE BBC COMPUTER.

The MERLIN SCRIBE uses the disc on your computer the same way that professional systems costing many hundreds of pounds do.

Until now any document you wished to create has been limited to the few pages which could be squeezed into your computer memory. This means the computer is really using the disc as if it were a cassette!

The SCRIBE can create documents far greater in size than the computer memory, and really uses the disc as it was intended to be used. SCRIBE automatically loads and offloads pages between disc and memory without you even knowing it's happening!

Amongst the many super features available are:

- * Optional 40 & 80 column screen format selection.
- * On screen formatting - you see it as it's printed INCLUDING UNDERLINING.
- * Right justify, word wrap, insert, delete, move copy & centre.
- * Document merge (will merge two documents into one from disc).
- * Addresses all four drive units allowed by your BBC disc system.

Plus many more professional features.

SCRIBE comes in ROM with five minute fitting instructions, printer utilities on disc and a comprehensive manual.

PRICE £59.95 (incl. VAT + post and packaging 60p)

Merlin Computer Products (Bucon Limited)

35/36 Singleton Street, Swansea, SA1 3QN Tel(0792) 467980(3lines)



FILE — PLUS

an exciting database package for the B.B.C. micro computer equipped with Acorn compatible D.F.S.

★ General Features

- Easy to use - Full colour - Help information always on screen on bottom 5 lines
- Design any number of data entry forms using a "paint" on screen technique - any of these forms may be used to add, delete, update, print or spool records from your data base.
- Forms may be 3 screens in size - each screen occupies 20 rows by 40 columns.
- Forms may contain any number of text and numeric fields, together with background text.
- Full printed and spooled output formatting via embedded commands !S, !P, !F, !C, !L, !W, !X, !R, !I
- Database may occupy the total online storage capacity of a system - typically up to 800K
- Query Language provides full arithmetic and selection facilities for records plus quick search on text.

★ Query Language Features:

- Operators allowed - Unary minus, -, +, /, *, =, <, >, <=, >=, <>, &, !, →
- Precision — $\frac{+}{-}$ 9999999999.9999
- Keywords — Assign, Compare, Display, End, Goto, Iff, Ift, Print, Read, Search, Spool, Update
- Full screen program entry
- ★ Applications include — Budgets, Labels prints, Mail shots, Club memberships, Collectors records, Household accounts, etc.

Supplied on a 16K ROM together with a 70 page manual and full fitting instructions for £49.95 inc. or enclose S.A.E. for fact sheet.



88 Willowhayne Drive, Walton-on-Thames, Surrey, KT12 2NR

MAKE THE MOST OF YOUR COMPUTER.

INTERFACE PUBLICATIONS

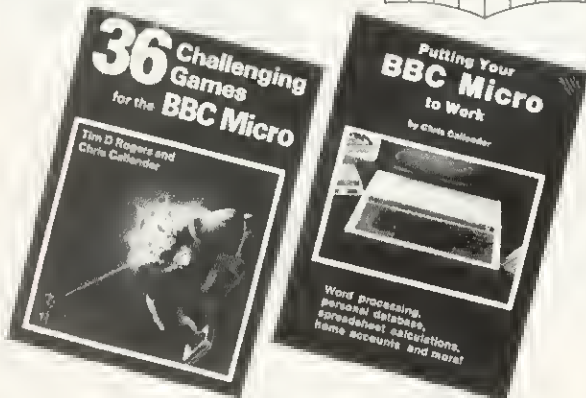
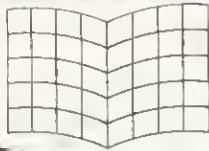

**Acclaimed books from the
experts . . .**

- Dynamic Games for your Electron
Neal Cavalier-Smith. £4.95
- 36 Challenging Games for the BBC Micro
Chris Callender and Tim Rogers. £5.95
- Let Your BBC Micro Teach You to Program
Tim Hartnell. £6.45
- Putting Your BBC Micro to Work (includes a full
word-processing program, plus 14 others)
Chris Callender. £4.95
- Creating Adventure Programs on your Computer
Andrew Nelson. £4.95
- The Easy Way to Program Your New Computer
Tim Hartnell. £3.95
- Practical Applications for the Microcomputer
in the Home.
David Hole. £4.95
- The Art of Structured Programming
Peter Juliff. £5.95

These books are available from most book and computer stores. In case of difficulty, order directly from us.

**Interface Publications, Dept. QAU,
9-11 Kensington High Street, London W8 5NP.**

Please send me the indicated books. I enclose £ _____

Name _____

Address _____

INTERFACE PUBLICATIONS

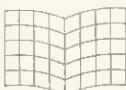

We're the Experts.

(TRADE ONLY) Interface Publications are distributed exclusively in the UK and Eire by W H S Distributors. Export trade handled by Interface Publications.)

HITACHI

▲ A

B ▼

&

SPIDER SYSTEMS

At the leading edge of technology

- * 500K on one 3" rigidly cased disc.
- * Compatible with all filing systems for the BBC MICRO.
- * Software and hardware compatible with 5 1/4" disc drives. May be run in tandem.
- * Very low power consumption, uses BBC's own power supply.
- * Track to track access time 3 ms.
- * Data transfer rate 125 K/b sec.
- * Steel case matches BBC Micro finish.
- * Ultra-reliable – fully guaranteed for twelve months.
- * Pack includes all leads, manual, utilities and disc.
- * Superb value for money.

Please send me:

- Single Disc Drive Double Sided Pack @ £252.00.
 - Double Disc Drive Double Sided Pack @ £491.50.
 - Single Disc Drive Single Sided Pack @ £195.85.
 - Double Disc Drive Single Sided Pack @ £360.60.
 - Pack of 5 3" Discs @ £22.50
 - Pack of 10 3" Discs @ £41.00
- All prices include VAT, post and packing.

Name _____

Address _____

Generous Dealer Terms Available



SPIDER SYSTEMS

Web House, 29 Elmfield Road, Stockport SK3 8SE
Telephone: 061-483 7692

BACK issues Byte, Kilobaud, etc. See list. Smith, 84 Edenfield Gardens, Worcester Park, Surrey KT4 7DY

SINCLAIR software. Over a hundred games. For list send sae to Andre Desilva, Pilgrims School, Firie Road, Seaford, Sussex.

PRINTER for BBC. Microline 80, used once. Cost £250. With paper, spare ribbons, cable £165. Tel: 01-467 6533 (day), Farnborough (Kent) 51055 (evenings)

ACDRN Atom 12k RAM, 1p ROM, VIA, and Program Power Toolbox. Psu, some books and tapes: £50. 9 Sartfield Road, Forest Town, Notts. Tel Mansfield 649815 after 6pm.

AMDEK DXY100 plotter, ideal for BBC. Complete with 3D software, sample BBC plots if required. Cost £699, accept £299. Perfect condition. Write Taylor, 24 Sutton Mead, Chelmsford or ring Chelmsford 469207.

CUMANA disc drive 100k c/w leads, on board power supply, manual plus 10 diskettes. £200 the lot. Call John, Brentwood (0277) 210603 any time. John Merril, 20 La Plata Grove, Brentwood, Essex

ATDM 12k + 12k + Tool Box ROM, Wordprocessor ROM. All books, almost new. Offers around £100. Contact Maidstone (0622) 50404.

ACDRN Atom, fully expanded + manual. Mint condition. Also two EPROMs included. Psu + leads. Also included: bus extension interface and printer port. It's packed full! Any offer considered. Telephone Newcastle (0632) 757654

CDMPUTING magazines for sale. Personal Computing, Practical Computing, Computing Today. All 1980 to 1982. Practical Electronics, 1980 to 1984. Offers? Faller 01-449 1808 after 6pm.

DISK drive. Toshiba double sided 200k, 40 track. One month old, cased with cables, and games/utilities disk £115. Tel Cambridge (0223) 354167

BBC disc upgrade kit with Acorn release 0.90 DFS EPROM. Fitting instructions provided. £50. Tel 0734 692647

BBC software including Shuttle, Road Runner, 3D Bomb Alley, Cybertron Mission, Killer Gorilla, Eldorado Gold, Countdown to Doom, Gorf, 737 and Moonbase Alpha. For sale only. Ring Steyning 815411.

SEIKOSHA GP100A printer. Adjustable tractor feeds. Complete with dust cover, manual, interface cable, and screen dump software for BBC micro. Original packing. Excellent condition. £165 ono. Kidderminster 60242.

WANTED. Software for Acorn Atom, especially educational. Will also buy games. Games wanted: 747, Cyclon Attack or any adventure games... Tel 061-499 1598.

SWAP BBC software with me. All types of programs in an extremely large selection. Ring Leicester (0533) 710889 and ask for David or write with your list to: 45 Glenway, Qadby, Leicester LE2 5YF. Preferably ring me after 4pm.

SWAP educational programs, utilities and games. Write enclosing list to L. Ratna, 22 Elmcroft Avenue, NW11 0RR.

PRISM acoustic modem for BBC computer with all cables and ROM chip software. £40 ono. Horsham (0403) 56678 (evenings).

CASHBOOKS + Final Accounts, Gemint. Ideal small business. Hail price (BBC B). Phone Lewis, 021-373 1163.

SWAP your BBC software? I have large selection of software. Contact John after 5pm on 0744 817787 or write with list to 121 Stirling Crescent, St. Helens, Merseyside WA9 3TY.

BBC software to sell/swap. Over 300 titles. All the latest stuff going about. Phone on 0702 521903 or write to Simon, 42 York Road, Rayleigh Essex. Discs/Tape.

CBM 3032 computer, two C2N cassette decks, 3022 printer, all leads and manuals. Excellent condition - hobby use only. Delivery 100 miles Newcastle £325. Tel Calder on 0670 352716 (9-6) weekdays.

WANTED Teletext adaptor for BBC, in exchange for Atari VCS and 20 cartridges. Also wanted: Prism acoustic modem with full documentation and leads in exchange for Casio-Organ and bar-code reader. Tel 041-946 9110.

CUMANA CS100 disc drive (100k). Integral power supply, with leads formatting disc and instruction book. Purchased Xmas 1983. £170 for quick sale. (BEEBUG price £225). Tel Stirling 61501 (upgrading to double drives).

PRINTER - Tandy 4 colour graphic printer, CGP115 £100 ono. Sgt. C. Boyd, Sgts Mess, RAF Gatow, BFPO 45.

ACORN Atom 12k RAM, 12k ROM plus games packs 1, 4, 7 and 8 plus 5 tapes plus manual £80 ono. Phone 061-962 6754. G. Armitage, 18 Urban Road, Sale, Cheshire M33 1TX.

ATDM 12k + 12k, fp, psu, £50. Tel: Southend 715708, Mr. Lorrinan.

WANTED official Acorn DFS manual. Any reasonable price paid. Phone David (0324) 558692.

WANTED Gaelsett ECFG graphics utility: new version preferred. Top price paid. Tel: (0786) 3491 evenings.

SOFTWARE for sale. Rocket Raid, Sphinx adventure, Meteors, Starship Command, Super Invaders £5.50 each. Planetoid, Roadrunner, Daredevil Dennis £4.50 each. All originals, will consider swapping for other programs. Phone 0259 60529.

BBC model B, Advanced User Guide, 50 magazines, lots of business and games software. Large range of books. Worth over £650. Offers? Write to O. Soll, Blackdown Farm, Leamington Spa, Warwickshire CV32 6OS. Recorder also available.

WANTED BBC micro disc interlace and/or disc drive. Phone Canterbury (0227) 58529.

SWAP/sell BBC software. Over 100 of the best games ready to swap for other BBC software or sell at very agreeable prices. Contact Nigel (0494) 785178 after 6pm.

SWAP/sell BBC software. Over 100 programs on disc and tape. Contact Gavin, Chesham (0494) 782993 after 5pm.

TANDY CGP115 printer, excellent condition. Comes with paper, pens and manual £85. G. Digby, 44 Lucy Hall Drive, Baildon, Shipley, W. Yorks, BD17 5BH.

CENTRDNICS 730 matrix printer with parallel interface. Produces good quality text. As new. Complete with lead for BBC, £135. Superior Software's Sharpshooter package £12. Acorn DFS chip £20. Phone Shetfield (0742) 745027.

DISC drives. Student and computer break wants disc drive and/or interface. Ring 08513361 and ask for Sandy.

ELECTRDN + software + assembly language book + Elbugs + £50 for a BBCB 1.2OS. Please phone Aberdeen (0224) 54436 after 6pm and ask for Philip.

SWAP disc and tape programs. I have a large (over 500) amount of software. Please write with list to Steve, 21 Laurelhurst Ave, Pensby, Wirral L61 9NY.

BBC and 100k disc drive + DFS, Exmon ROM, Quickshot joystick, Basic II, OS 1.2, hi-fi output, software (vast) on disc and tape. Joykey program. £550. Telephone Hornchurch (04024) 71789 (after 5pm).

CUMANA 100k CS100 disc drive, with leads, instruction book and formatting disc. Integral power supply - 3 months old, £170 for quick sale (RRP £245). Telephone Stirling 61501. (I am upgrading to double drives.)

ATDM software: I will buy, swap, sell large collection. All the best makes. A + F, Program Power etc. Send details to B. Nesbit, 601 Plessey Road, News-ham, Blyth, Northumberland NE24 4BZ. List appreciated.

BBC model B required. Pay up to £250. Phone 01-570 5201 after 5pm.

CANON bare 40trk s/s - £95. Cables - £5. Watford Eprommer - £50. 12-ROM board - £25. Software: Android Attack, Muproc, Lisp, Graphs and Charts, J.R., Castle of Riddles, Games of Strategy. Offers? Tel: (0225) 859401 (Guy).

SWAP Uncased RGB colour monitor for double sided disk drive, anything considered. Mike Wing, Hull 0482 791337.

C.U.C. DFS (chip only) for sale: only £15! Phone Simon Ward 01-398 2523 evenings.

WANTED Acorn Eurocards. Pay £10 each for 6809, Teletext, 80 x 25 VDU, also 5A Atom power supply wanted. Pay £5-10. Will haggle. Write: 128 Hoadswood Road, Hastings, E. Sussex TN34 2BA. Telephone 0424 432649.

ACORN Electron, 3 months old, little used, some software £180 ono. Reason for sale: buying BBC. Telephone 01-689 5960.

BBC tapes. Toolbox £12, White Knight £8, Games of Strategy £4, Pinball Arcade £8, Fighter Pilot £4, Monaco £6. ROMs: Wordwise £20. Graphics Extension £23. Peter Davies 01-549 2347 (Kingston).

WANTED circuit details to convert colour TV (Thorn 3500 chassis or similar) to RGB TTL input. Also, daisy wheel typewriter with interlace for Atom. Tel: 0952 89454.

ACORNSOFT Games Pack 4 for Atom. Startrek, Four Row, Space Attack. Unopened pack. £7 + 50p for p/p. Tel: 0952 89454.

ACORN Atom wanted. Will give up to £50 for fully expanded Atom with VIA and printer output. Write to Richard Hutt, Lingmill, Abbey Road, St. Bees, Cumbria CA27 0ED.

TANDY model 1 16k cassette recorder, monitor and 4 manuals. Offer me £250 Irish currency. Software includes: Invasion Force, Blackjack, Dancing Demon, Backgammon, Flying Saucers, Pyramid and Chess. Excellent condition. R. Whyte, Prospect Mullingar, Co. Westmeath, Ireland.

ELECTRDN users. We have an extensive collection of software games - Bugbyte, Program Power, Acornsoft, A & F, Visions etc. We want to swap. Send your list for ours. Andrew McCol, 209 Allison St., Glasgow.

TDRCH Z80 disc pack plus Perfect software, manuals and discs to be sold. Invoice and original packing-up available. Ring: 01-789 7261.

COMPUTER Concepts Beebcalc ROM for sale - only £25 ono. Genuine reason for sale. Phone Justin on 01-440 7053 between 4-7pm. Includes manual and full fitting instructions. First come, first served.

ICL Termiprinter for sale, BBC compatible uses serial port! £45 ono. Phone Sevenoaks (0732) 451984.

BBC B, compatible cassette deck, manuals, leads, games, hardly used since new, £350. Contact D. Norris, 11 Lansdowne Avenue, Slough (Slough 822961 evenings).

ATOM 12k + 12k, colour, + software. Bugbyte, Database, Diary, Adventure, Magic Book, Getting Acquainted with Atom, all for £65. No offers. R. Patel, Tel: London 01-452 4076 after 6pm. Caller collects.

ATARI VCS: £44.95 including 4 joysticks, 2 paddles, Pacman, Combat, Space Invaders, all leads needed etc. Also C90s 40p, C60s 30p (while they last). Write to Asa Winder, 186 Overdale, Ashted, Surrey.

BIG EARS speech recognition system for BBC. As new £30 ono. Acornsoft software nine titles in original packing £40 ono. Including Rocket Raid, Snapper, Monsters, Meteors, Planetoid. Phone Adam Morriss, Dane End 31 t.

PCS

PEDRO COMPUTER SERVICES LTD

BBC CARD INDEX

- ★ DISK BASED FILING SYSTEM
- ★ USER DEFINED SCREEN
- ★ RECALL BY ANY FIELD
- ★ PRINTER OUTPUT
- ★ SORT ON ANY FIELD
- ★ NUMERIC OPERATION ON FIELDS
- ★ UP TO 1000 RECORDS PER FILE
- ★ 20 USER FIELDS
- ★ 250 CHARACTERS PER FIELD
- ★ SUITABLE FOR SINGLE DRIVE

£36.50 inc. VAT & P/P

We are able to supply most BOOKS, SOFTWARE and ACCESSORY FOR THE BBC, ZX SPECTRUM AND CBM 64.

We specialize in home computer control

PEDRO COMPUTER SERVICES LTD
245/247 CLERKENWELL ROAD
LONDON EC1M 5RS

ACCESS/VISA

EXPORT

BBC DISC DRIVES

SINGLE
£239
400K



DUAL
£429
800K

- 40/80 Track switchable
- All cables included
- User disc system guide ● Ready to go
- Utilities disc - 6502 disassembler
- Merge - Relocate - Screen dump

PRINTERS

SMITH CORONA TP1
DAISYWHEEL £235

(If you order enclosing this ad.)



DOT MATRIX

GEMINI 10X (80 col. 120 cps) £239
GEMINI 15X (132 col. cps) £339
DELTA 10 (80 col. 160 cps) £375
EPSON FX80 (80 col. 160 cps) £410

* We sell cables, dust covers, paper etc.

COMWARE

CALL
FOR FREE
DATA

**ALL PRICES INCLUDE VAT
AND DELIVERY**

Call Eileen on Crewe (0270) 582301

◆ diamondsoft

A better way of computing

SUPPLIED ON CASSETTE
RUNS ON DISC OR TAPE

HOME ACCOUNTS BBC 32K £13.95 (INC)

Complete home finance system packed with sensible facilities to help you maintain up to date records of your BANK, CREDIT CARD, LOAN and SAVINGS ACCOUNTS. Keep track of CHEQUES, RECEIPTS, AUTOMATIC BANKERS ORDERS, BILLS WAITING PAYMENT and much more.
An essential asset for home or club.

BUSINESS ACCOUNTS BBC 32K £17.95 (INC)

Easy to use with small businesses in mind. Facilities include - PURCHASES, SALES, CASH, LEDGER and DAY BOOK LISTINGS, VAT ANALYSIS, CONTROL TOTALS and BANK RECONCILIATION. A simple but effective aid to efficiency.

FLEXIFILE BBC 32K £13.95 (INC)

A powerful, general purpose, file handling system. Quickly create, maintain, sort, select, save and print your own data. Develop complex systems with ease. Invaluable for Home, Club, Schools or Business Records. Offers the use of advanced software techniques to beginner and expert alike.

Cheques or P.O. to Diamondsoft Ltd., FREEPOST,
Cheadle Hulme, Cheshire, SK8 5YB. Tel: 061-485 8705

Educational
Engineering
Mathematical
Scientific

PROGRAMMING

PROBLEMS WITH METRIC OR SI UNITS?

UNIVERSAL UNITS CONVERTOR

The METRICATOR suite of programs for the BBC-B and ELECTRON may be your answer. Can convert ANY unit into ANY other compatible unit eg. KM/LITRE into MILES/GAL or BTU/HOUR/FT² into JOULES/SEC/M². "SI" may be specified and the correct SI equivalent automatically calculated. You do not need to know it. Saves hours of work.
15 UNIQUE routines designed for EASY insertion into YOUR program give instant access to many thousands of combinations of units.
Multiples and sub-multiples (mega, micro, nano etc) all handled automatically. Your own units may be added.
Tape and disc versions available. Both contain a library of units, a program to give immediate conversions and a demonstration program to produce conversion tables. Disc version uses a random access file to reduce RAM requirements and BINARY CHOPPING for VERY fast access.
All techniques including data packing fully explained in detail. The routines are written to a VERY high standard. We are so confident that we GUARANTEE to include ANY conversion you specify when ordering.
NEED ANYTHING? Contact us for any mathematical or scientific methods. We either have it or will find it.
JOIN US! Buying METRICATOR entitles you to send your own high standard scientific and mathematical programs for possible inclusion in our library and turn your invention into cash.

METRICATOR Prices (Inc p&p)

Tape version-----£6.95.
Disc version(Acorn standard 40 track) -----£9.95
including supplementary disc file and
maintenance programs-BBC only.
Instruction manual and program listing only-----£1.75
(refundable against subsequent program purchase).

Remittance to:-

"EMS Programming"
134 Buckswood Drive
Crawley
Sussex, RH11 8JG.

Please state BBC or ELECTRON.

COMPUTER Concepts Beebcalc ROM for sale - only £25 ono. Phone Justin on 01-440 7053 between 4-7pm. Includes manual and full fitting instructions.

MICROSTYLE Quickshot joystick for BBC B. Brand new (unwanted gift), £15. Also, sell or swap BBC software. Moonraider, Liberator, Sphinx, Galaxy Wars, Painter, etc. Phone Donhead 344 - ask for Richard.

WANTED 2764 or 27128 new or used EPROMs for BBC micro. To be used for A-level physics research project. Offer £3 and £10 each. Phone Andrew on (02756) 5279.

AMBER printer including cables, interface for BBC and Atari, spare paper rolls and ribbon, £70. Also lots of BBC software on disc to swap. 06845 64607.

SOFTWARE to swap? Over 250 titles available. Ring 0908 74497 or 0908 565077 for details and/or printed list. After 5pm and before 9pm. All the latest titles: JCB, Mine, Bumble Bee, etc.

BBC software to swap. Arcade, adventures and educational. All on disc. Tel: 09853 365 after 6pm (Wilts).

ATOM wordpack ROM wanted urgently. Tel J. Herbert, Billingshurst 3647 or write to 8 Gorselands, RH14 9TT.

USER group. Anyone interested in starting one in Birmingham? Please write enclosing sae, or phone. Allen, 3/177 College Road, Moseley Birmingham B13 9LJ. Tel: 021-778 5297.

SOFTWARE for sale. BBC and Acorn-soft games £5 each. Other software houses £4 each. (Others include Micro Power, Virgin, Superior). Good as new. For details, ring Canon Pyon 217.

BBC B 2 months old £335. Cumana single disc drive £140. Printer Seikosha GP100A £140. All as new. Phone 0703 559027.

REPLICA II copy all discs £9. Hunchback, 3D Bomb Alley, Gunsmoke, Dogfight, cassettes £4 each. Spacehawks, Zany Kong, Zors Revenge; Cassettes £3.50 each. Tel: Lea Valley 719 159 after 4pm.

■ **Experienced** Basic and machine-code programmer offers specialised programming service. I will write your program specifically to suit your exact requirements. Phone Mat Biggs on 01-693 8434 anytime.

■ **Disk** drives. Dual cased units d/s-d/d 80 track for BBC. Group purchase of 5 1/2" Tracker 2.0 drives from Data Track Technology. £310 including VAT, postage, cables and formatter disc. Details: Ring Baldock 895405.

■ **Utilities** galore: copier, tape to tape/disk, handles Basic, m/c, tiles 300/1200 bd, locks; function key editor/data cruncher; character editor; memory display; set of keys. Cassette £5 inc. A Slinger, 17 Olney Road, Emberton, Bucks MK46 5BX.

■ **Fantastic** definition, colour detail and 80 columns clearly displayed on new range of video monitors. Composite version gives brighter and sharper pictures on your VCR. Tel 0689 46116 for details.

■ **Skeletal** programming with the BBC micro. Revolutionary new method of learning to program used in schools and universities. Disc-based. Eighteen program package £25 from Nicholas Fisher, Humford Mill, Bedlington, Northumberland NE22 5RT.

■ **Personalised** share portfolio program BBC B, professionally written, menu driven. Individual and total summaries, capital gains calculation, graphic presentation. Takes guesswork from investing. £6. M A Smith, 2 Solway Rise, Dronfield Woodhouse, Sheffield S18 5ZR.

■ **Fourteen** original family games for the Beeb. Test your skill and concentration with these exciting games. A bargain at £4.95. Brian Taylor, 16 Letchworth Cres, Chilwell, Nottingham NG9 5LL.

■ **Why** not let us produce your program on disc. We have both 5 1/2" and 3". Disc Image, Unit 5, Stockey End, Peachcroft, Abingdon. Oxon OX14 2NF.

■ **Teletext** screen editor, ideal for title pages, graphics displays, teaching packages. Simplifies block graphics and teletext codes. Save screens and reload for amendment. Full instructions. Model A/B, OS1.0/1.2. £5.75. M Wilkins, 12 Fairmead, Rayleigh, Essex.

■ **Rolanddg** DXY100 plotters, brand new, guaranteed 1/2 price. Cost £699 - special offer £399 inc VAT and free demo 3D software. Write or call for demo, brochures and demonstration plots. 10 Baddow Rd, Chelmsford, Essex. 0245-356218.

■ **Archive** those costly disks to cheap tapes. One C90 tape can hold 4 100k discs. Restore program written to each backup tape. Only £4. T. Jones, 27 Gloucester Gardens, Cockstosters, Barnet, Herts EN4 0ON.

■ **Joysticks** - top quality at amazing low price. Only £9.95 a pair. Easier to handle and faster than others costing twice as much. Cheque/PO to Peritron, 21 Woodhouse Road, London N12 9EN.

■ **BBC Buggy** as new, £95. Grafpad digitiser £80. Four colour printer £80. Aries B20 RAM Expansion £50. View wordprocessor £25. Computer Concepts' Graphics ROM £15. Disc Doctor £10. Termi ROM £10. (0344) 886178.

■ **Disc** cataloguer, 32k. Reads titles, filenames, types into index. Machine code edit, sort, etc. The Who's Who of your discs - at your fingertips. £5.95. Toto Software, 26 Bridgeway Road, Kirkintilloch, G66 3JB.

■ **Europe.** Use your BBC micro to search databases all over Europe. Software listing £2, disc £5. Booklet describing hosts, networks, costs, addresses etc £5. D. Holmes, 14 Sandringham Road, Dersingham, Kings Lynn, Norfolk.

■ **Chuckie-cheat** for BBC micro Chuckie Egg. Choose the Chuckie Egg start level and its number of lives. For the listing send cheque/PO for 70p to N W Deeley, 46 Everest Avenue, LLanishen, Cardiff CF4 5AS.

■ **Oiscat** disc program database reads and stores programs directly from disc. Holds over 2000 programs: search, printout, amend etc. Acorn DFS £8. State 40/80. Sae details: Royston Mount Pleasant, Simpson, Milton Keynes.

■ **Make** written lecture slides by photographing your television screen. 'Slidetext' displays teletext (single or double height) in eight colours. Saves files of 20 pages. Disc compatible tape. £17-25. D. Robinson, 41 Trafalgar Road, Birkdale, Southport.

■ **View** printer drivers for Oki 92/93, Juki, Epson FX80. Use full printer features. Cassette £5 each, all £7.50, extra £1 for disk. Industrial and Commercial Computers Ltd, 9 The Tynings, Clevedon, Avon.

■ **Bulldog** Programs. For a full list of our educational software for the BBC micro send sae to Bulldog Programs, 93 Main Street, North Anston, Sheffield S31 7BE.

■ **View** with FX80? Set drivers gives access to elite, proportional, bold, italic, condensed, enlarged, subscript, superscript, £, ". Cassette £6 with documentation. Transfers to disc. Abington Micro-Consultants, 34 The Crescent, Northampton NN1 4SB.

■ **Wordwise.** Excellent word processor for the BBC only £37 (inc). Disks 5 1/2" d/s d/d 10 for only £22 (inc). Private Tutor Europe, 29 Holloway Lane, Chesham Bois, Amersham, Bucks. (02403) 21702.

■ **Bugbear** for microcomputer program advice. Program won't work? Software manual confusing? Program planning? Any micro - no problem too small. Ring professional programmer Frances Daniel (0926) 55376 for initial chat (after 4pm weekdays).

■ **Unbelievable** but true! Clemoes Software put up to 3 absolutely top quality games on 1 cassette for £7.95! Arcade games, games of deduction, plus other cassettes. *Available at W H Smith for only £6.95

■ **BBC** amplifier 2-watt output, battery operated (PP3). DC I/P jack with audio pick/off module, fitting instructions £23. Mains adaptor £6. BBC dc/lead £2.50. Plus-4 Electronics Ltd, 163a Boston Road, Hanwell, London W7 3QJ. 01-579 9691.

■ **AC** Linear Circuit Analysis Program for BBC B. Analyses Circuits with up to 16 nodes and 80 components. Cassette £35. Disc £45. Telephone Number One Systems. St Ives (0480) 61778. Access welcome.

■ **BBC B** CFS file handling program to store current account records. Keep your balance in credit! Nice features, includes 80 column display. £5 cassette. Sae for details. 37 Ravenswood Drive, Woodingdean, Brighton, Sussex.

£10 SMALL AD SERVICE

Please include your cheque for £10 made payable to Redwood Publishing. This is the standard fee. Don't forget your name, address or phone number. Send cheque plus form to Acorn User Small Ads, 68 Long Acre, London WC2E 9JH.

THE MICRO PULSE 3 INCH 100K DISK DRIVE + MIRROR

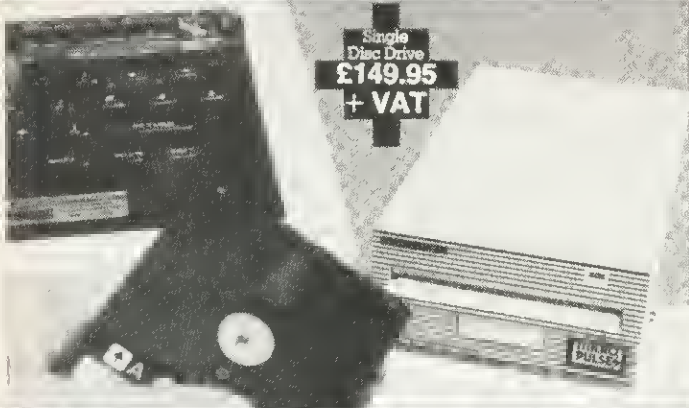

Single Disc Drive
£149.95 + VAT

- ✦ Assembled in Britain ✦ Robust metal case, BBC beige colour
- ✦ Complete with BBC cable ✦ Fully compatible with Acorn/BBC DFS
- ✦ Can be linked in tandem with 3 1/4" disc drive for easy transfer of software
- ✦ Red/Green LED indicates which side of the disc is in use
- ✦ Includes 38 page disc operating system manual
- ✦ Includes 40/80 track formatter utility disc
- ✦ Uses standard Hitachi hard-cased 3" discs (automatic steel shutter protects exposed part of disc surface)
- ✦ Additional double-sided 3" discs available ex-stock

✦ DUAL 3 INCH (2 x 100K) DISC DRIVE **£299.95 + VAT**

✦ MIRROR 3" CASSETTE-to-DISC utility program Discette
Up-loads approx 20 cassette-based programs ...
(10 on each side of the disc) ...

£9.00 + VAT

Trade enquiries welcome

please contact: Gareth Littler
Mark Howard or
Judith Allen at
Micro Pulse
Division



Churchfield Road,
FRODSHAM
Cheshire WA6 6RD
Tel: 0928 35110

THE MICRO PULSE EXTERNAL ROM BOARDS

For the BBC Computer and the
Acorn Electron

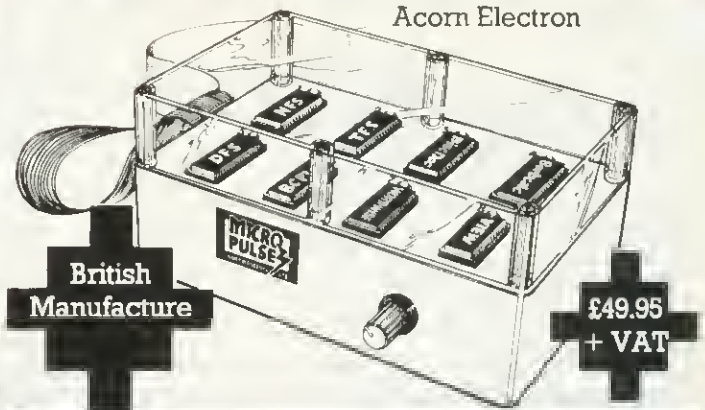

British
Manufacture

£49.95 + VAT

- ✦ BRITISH MANUFACTURE ✦ ALLOWS 5 ROMS ON LINE
- ✦ HARDWARE-BASED ROM SELECTION AVOIDS SOFTWARE INTERACTION BETWEEN UTILITY ROMS
- ✦ SWITCH TO REQUIRED ROM USING MANUAL SWITCH OUTSIDE THE UNIT
- ✦ RED LIGHTS INDICATE THE SELECTED ROM
- ✦ HIT "BREAK" TO ACCESS ROM, NO NEED TO USE SOFTWARE COMMAND
- ✦ INCLUDES ZIF SOCKET, FOR INSTANT CHANGING OF A SELECTED ROM
- ✦ INCLUDES BBC CABLE AND ROM SOCKET CONNECTOR
- ✦ INCLUDES SIMPLE FITTING INSTRUCTIONS, JUST PLUG IN AND GO!

please contact: Gareth Littler
Mark Howard or
Judith Allen at
Micro Pulse
Division



Churchfield Road,
FRODSHAM
Cheshire WA6 6RD
Tel: 0928 35110

ACORN USER ADVERTISEMENT PAGES - JUNE ISSUE

3D Computers	88	Datatrak	38	PHIMAG	19
3SL	152	Dataware	98	Pace	158
A J Vision	164	Diamondsoft	128	Pedro	174
AB Designs	138	Diamondsoft	174	Printerland	141
AMS	142	Digital Peripherals Ltd	167	Proxima Software	87
Acacia Compute	138	Discotek	48	RPG Micro-Systems	144
Ack Data	162	Display Distribution	78	Ricksoft	128
Acorn User Show	83	ECCE	128	SCI Ltd	60
Acorn	92	EMS	174	Salamander	124
Acorn	93	EIbug	160	Schumwari	109
Ad Index	176	Electronequip	114	Screens	107
Advent	138	Enigma	34	Sequential Software	122
Akhler	110	Flightdeck	152	Silent	152
Ampalsoft	30	GCC (Camb) Ltd	126	Simonsoft	98
Applied Real Time Systems	90	GSL	24	Sir computers	100
BBC Micro-User Show	12	Garland	28	Skywave	122
Beebug	129	Golem	107	Slogger Software	144
Beebugsoft	106	Harris-McCutcheon	116	Softsmith	130
Big K	118	Inmac	33	Software Invasion	76
Bits & Bytes	130	Inmac	64	Software Supermarket	65
British Micro	150	Interface	172	Spider Systems	104
Brother Industries	74	Kansas (Kansas Word Processor)	56	Spider Systems	172
C-Tech	8	Level 9	1	Superior Software DPS	156
CJE	119	MRM	14	Superior Software	157
CYB Design	168	Magic Software	116	Superior Software	70
Camb. Computer Store	109	Mayfair Micros	152	Superior Software	IBC
Cambridge Computer Consultants	137	Merlin	170	Superior Systems	147
Cambridge Micro-Centre	25	Micro-Fix	168	Synergy	32
Cases Computer Simulations	167	Micro-Net	72	Technomatic	4
Chase Data	80	Micro-Power (Ghouls)	BC	Technomatic	5
Cheetah Marketing	66	Micro-Vitec	155	Technomatic	6
Clares	112	Microaid	16	Torch	20
Com-soft	164	Microfast	73	Torch	21
Commotion	88	Micronet	11	U.C.C.	86
Computer Concepts	140	Micropower (Jet-Power Jack)	132	Victor-Morris	168
Computer Concepts	169	Micropower DPS	133	Vida-rebus	128
Computer Concepts	36	Micropower	23	Viglen	101
Computer Room	116	Midwich	59	Viglen	120
Computer Town	148	Mirrorsoft	50	Viglen	95
Computer Town	149	Molimerx	54	Viglen	97
Computerama	17	National Micro Centre	63	Viglen	99
Computraphile	98	Newark Video	164	Vine	10
Compware	174	Northern Computers	176	Voltmace	104
Comtec	162	OE Ltd	58	Watford	40
Coomber Electronics	107	Opus	74	Watford	41
Coomber Electronics	109	Opus	166	Watford	42
Croydon Computer Centre	144	Opus	26	Watford	43
Cumana	84	PACE	94	Watford	44
Cumana	85			Watford	45
DN Electronics	98			Watford	46
Datapen	34			Zygon	87
Datastore	168				
Datatap	170				

SPECIAL OFFER!
Order both directly from us and deduct £1 from each.

TWO SENSATIONAL NEW RELEASES FROM SUPERIOR SOFTWARE

**BBC
MICRO**

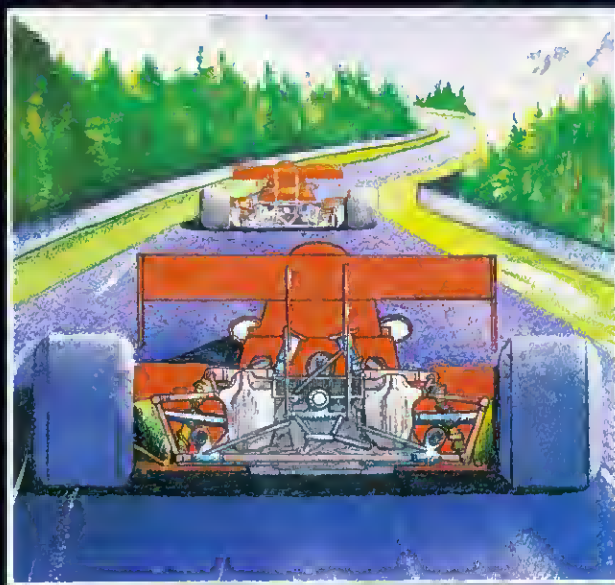
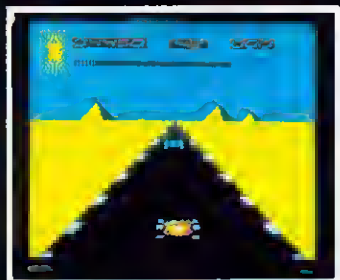
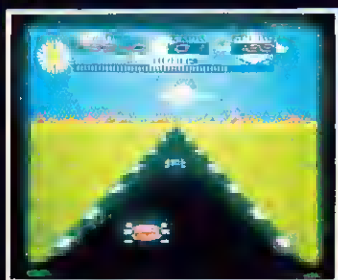

OVERDRIVE (32K) £7.95
A highly-addictive multi-stage 3D race game. You steer your car left and right, accelerate and decelerate as the opposing cars weave about the road. There are five different stages including night, snow, desert, and riverside scenes. To qualify for the next stage, you must finish in the top twelve. Incredible graphics give the impression that you really are taking part in the race. Highly recommended, and destined to become another top-seller for Superior Software.
●●●NEW RELEASE●●●

OUR PROGRAMS ARE NOW AVAILABLE FROM OVER 1000 OUTLETS THROUGHOUT THE UK AND OVERSEAS. SEE YOUR LOCAL DEALER!

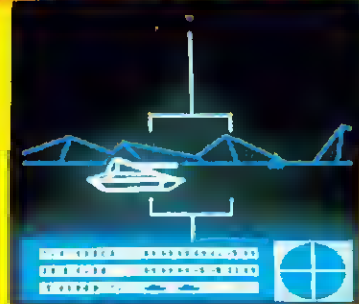
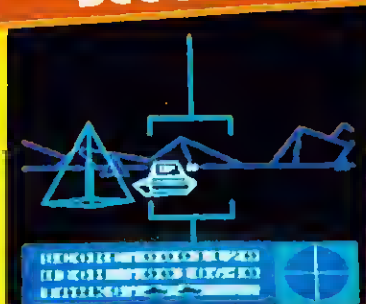

BATTLE TANK (32K) £7.95
An excellent game, made possible on the BBC computer only by the unique use of a dual-screen display and specially written plotting routines. You are a tank gunner looking out onto a mountain plateau. You see the distant mountains and the pyramid obstacles – and also the enemy tank. Your task is to shoot it before it shoots you. A scanner is displayed in the bottom right-hand corner of the screen. This displays the position of the enemy tank relative to you. You can then turn to get the tank in view. The next stage is to position the tank in the rectangular viewfinder by fine adjustments of your controls.
(KEYBOARD or JOYSTICKS)
●●●NEW RELEASE●●●

WE PAY UP TO 20% ROYALTIES FOR HIGH QUALITY BBC MICRO AND ELECTRON PROGRAMS



SUPERIOR SOFTWARE LTD.

Dept. AU5, Regent House,
Skinner Lane, Leeds 7
Tel: 0532 459453

OUR GUARANTEE

- (1) All our software is available before we advertise.
- (2) All our software is despatched within 48 hours by first-class post.
- (3) In the unlikely event that any of our software fails to load, return your cassette to us and we will immediately send a replacement.

AN EXCITING B.B.C. MICRO PROGRAM FROM BRITAIN'S LEADING SOFTWARE HOUSE!

GHOULS

Run through the creepy mansion to rescue the power jewels dodging ghosts and bouncing spiders. Leap over poison-smeared spikes, scamper along moving platforms and contracting floorboards, and use powerful springs to propel you onto overhanging ledges. Superb animation and sound effects.

Only **£7.95** (inc. VAT)



AVAILABLE FROM ALL GOOD RETAILERS INCLUDING SELECTED BRANCHES OF BOOTS.
WRITTEN BY JOHN MENZIES AND WH SMITH.
The following top titles are available for both the BBC Micro and Electron: Killer Gorilla £7.95/ Bendits at 3 o'Clock £8.95/Moonraider £7.95/Croaker £7.95/ Felix in the Factory £7.95/Felix and the Fruit Monsters £7.95/ Chess £7.95/Draw £8.95/Escape from Moonbase Alpha £7.95/ Cybertron Mission £7.95/Swoop £7.95/Intergalactic Trader £8.95/ Positron £8.95/Adventure £7.95.
SHOWROOM: NORTHWOOD HOUSE, NORTH STREET, LEEDS LS7 2AA Tel: (0532) 458800
MAIL ORDER: MICRO POWER LTD, 8/8a REGENT STREET, LEEDS LS7 4PE. Tel: (0532) 683186/696343
P & P: 55p per order
SPECIAL OFFER: Deduct £1 per cassette when ordering two or more

