

INTERNATIONAL DP

Also: converting from time-sharing to in-house Cobol, OCR, history and warehousing

CONTROL DATA ANNOUNCES the Disk Drive that surpasses the 3350; and needs no 3330-11 software conversion!

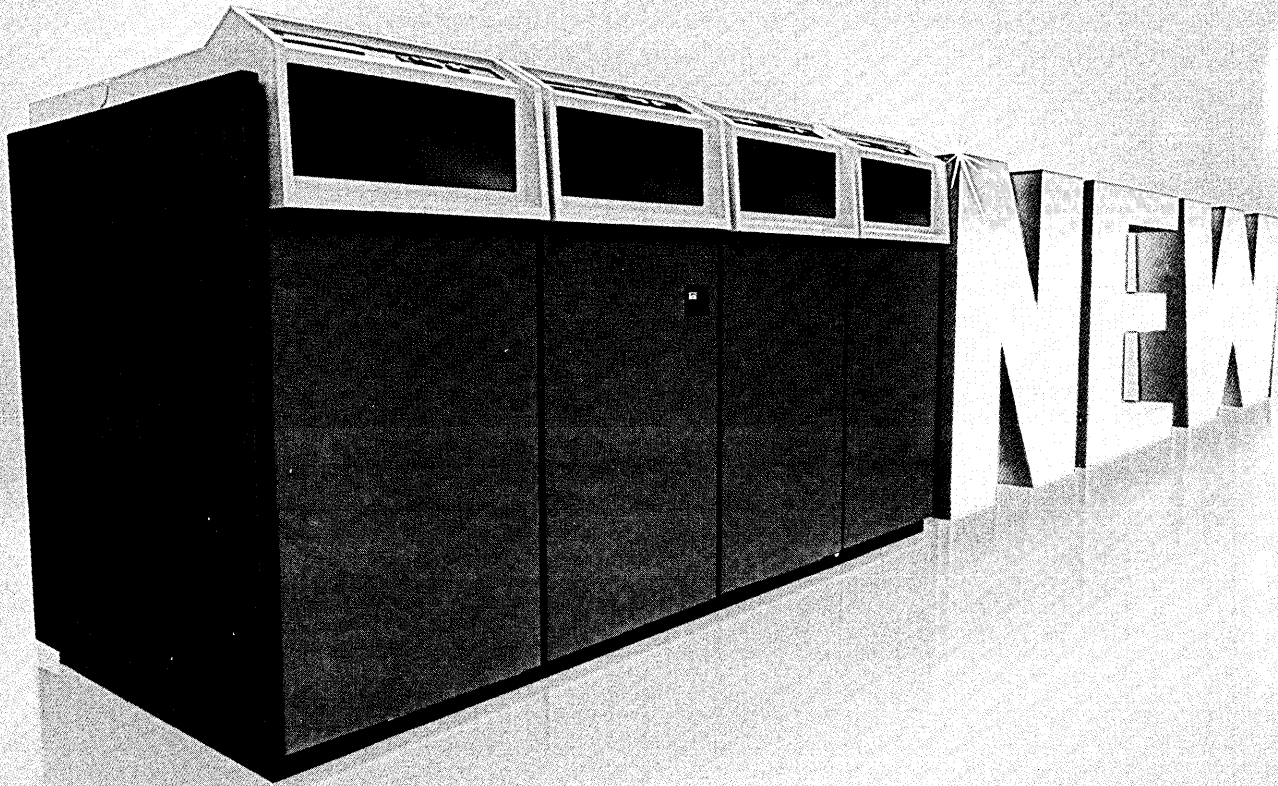

We have it.

Our new CDC 33801 — the newest member of our family of Sealed Module "Winchester"-Technology Drives.

Why install a 3350 and spend money reblocking and retuning your software — when CDC can offer you 25% greater capacity (400 MBytes) with no software conversion cost.

The CDC 33801 operates under OS and DOS systems as well as VS systems. You protect your software investment — and get better cost-per-byte — all at the same time!

What's more, CDC's new 33801 Data Module Drive provides 100% greater capacity than the 3350 when used in the 3330-11 mode. The CDC Sealed Module incorporates a fixed head (zero seek time) option. And, Control Data's optional 1.24-million-byte fixed head capacity

gives you 100,000 bytes more than the equivalent 3350 option.

Before you decide on a 3350, find out about the 33801. Compare. Discover the less costly, more flexible growth path of this expandable 33801 system. See how it enhances both 3330 and 3350 storage and can serve as a staging device for the CDC 38500 Mass Storage System.

Check out the CDC 33801, and you'll know it makes a better business decision.

For the price-per-byte and performance you need today plus a more logical growth path for 3330 users call (612) 553-4158 or mail the coupon to: Ronald L. Kamps, Sales Manager, Peripheral Product Sales, Control Data Corporation, Box 1980, Twin Cities Airport, St. Paul, MN 55111. Dept. D-96.

Ask the CDC Peripherals People

Name _____ Title _____
Company _____ Address _____
City _____ State _____ Zip _____
Area Code _____ Phone _____

GD CONTROL DATA
CORPORATION

Talk to us...

We communicate

So do all our

KeyProcessing™ Systems

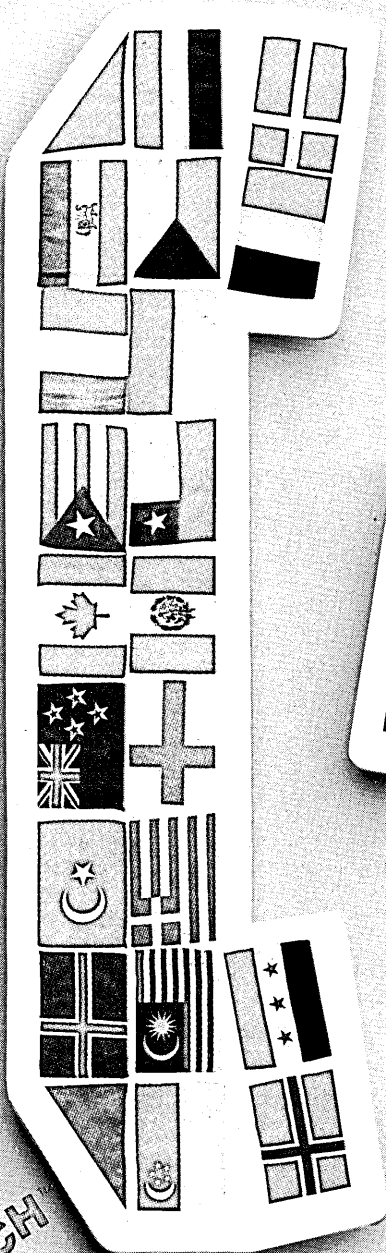
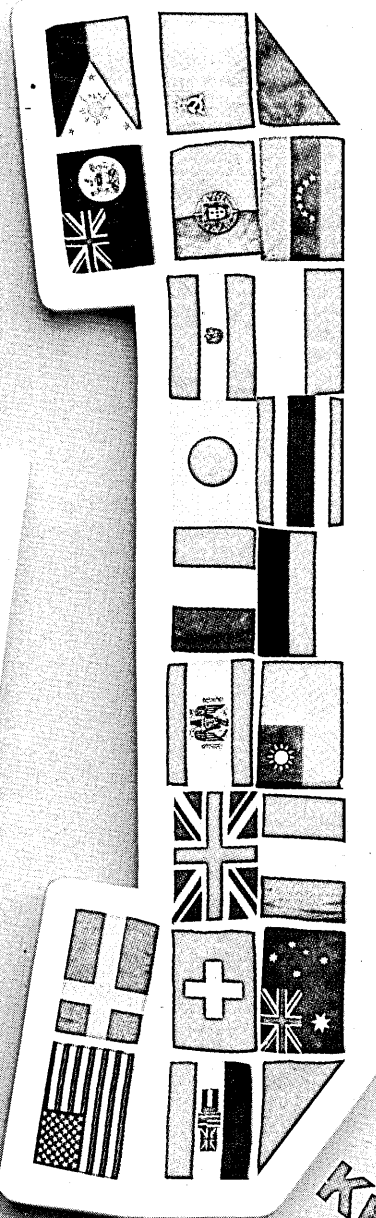

Signaling a new era

in data entry communications, CMC's TeleBatch™ option does it all — remote data entry, remote job entry, and remote printing — all concurrent with a full complement of active keystations.

The KeyProcessing Family

offers the widest range of data entry systems available today. With features and options that will serve you tomorrow too. Like TeleBatch, and the industry's most comprehensive array of management control reports.

TeleBatch

provides decentralized data entry without sacrificing centralized control over quality and procedures. TeleBatch is fast, with speeds up to 19,200 bps. And it's simple to operate — with unique Communications Control Batches automatically performing all operator and remote batch terminal functions.

Our customers say

that CMC's Management Control Reports are outstanding. The TeleBatch Log, for example, improves the effectiveness of communications by providing an audit trail of important communications statistics.

CMC KeyProcessing Systems

are installed and communicating throughout the world.

KEYPROCESSING™

Talk to us,

you'll be pleased you did. Call or write today for more information.

KeyProcessing and TeleBatch are trademarks of

CMC a division of **PERTEC CORPORATION**

2500 Walnut Avenue, Marina del Rey, P.O. Box 92300
Los Angeles, CA 90009 Telephone: (213) 390-8411

CIRCLE 4 ON READER CARD

TELEBATCH™

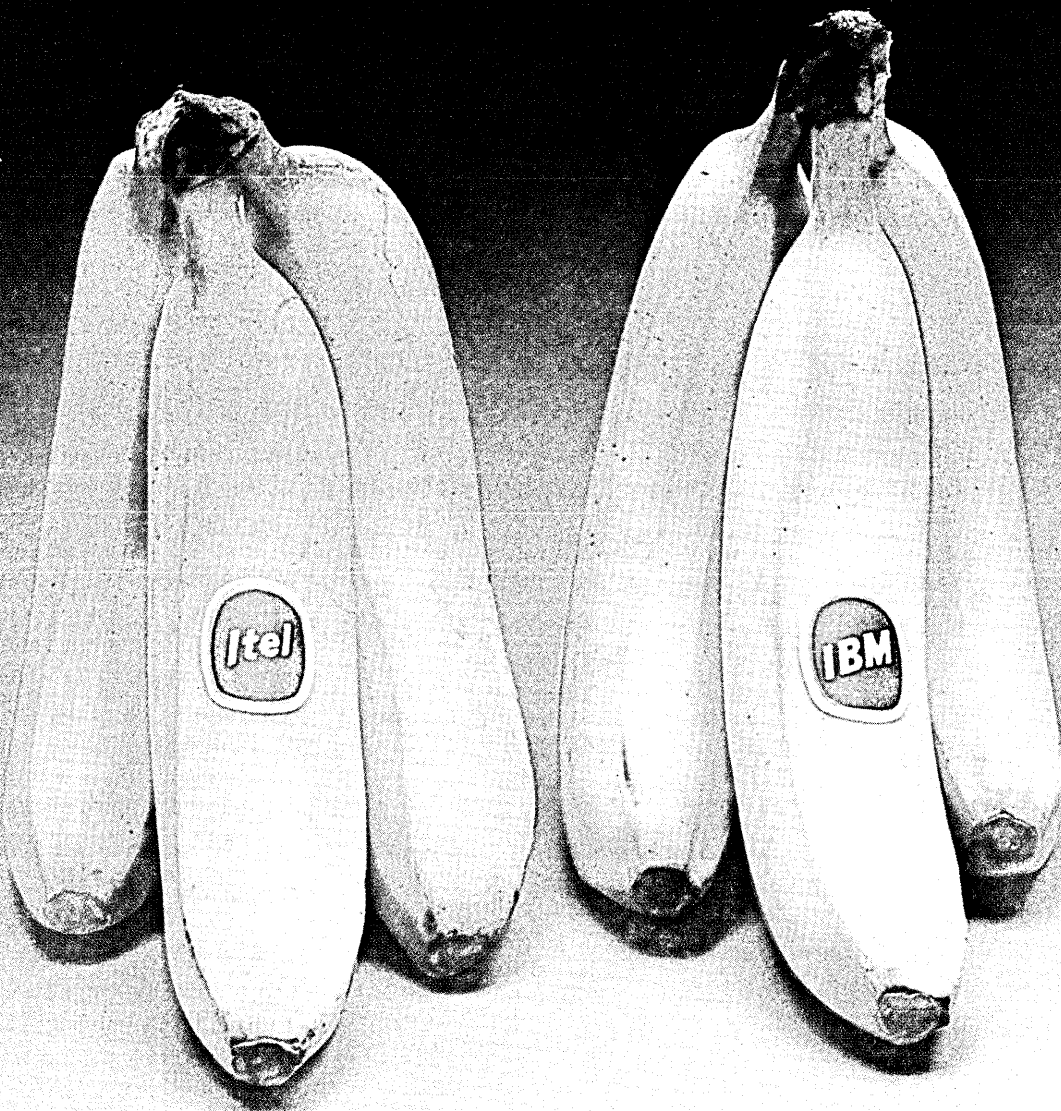

IN COMPUTER PERIPHERALS, THERE IS ONLY ONE ALTERNATIVE TO ITEL.

And that's no exaggeration, either.

It's something we can back up with fact after fact.

For instance: Did you know that we supply more plug-compatible

monolithic main memory and 3330-type disk drives than anyone else?

Moreover, when you deal with Intel the savings are enormous.

It's this kind of all-out creative effort that has put us right up there with IBM. Not only in computer peripherals. But in field engineering. In systems and software. In financial packaging. In total computer capability.

When it comes to experience and reputation, it's either IBM. Or Intel.

When you get to price/performance, however, there is no alternative.

There is only Intel.

INTEL
CORPORATION

Data Products Group
One Embarcadero Center,
San Francisco, California 94111
Telephone (415) 983-0000

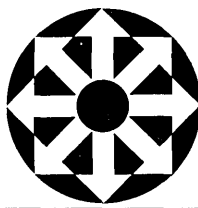

DATA MATION[®] 76

VOLUME 22 NUMBER 9

This issue 138,500 copies

SEPTEMBER 1976

FEATURES

56 THE INTERNATIONAL COMPUTER INDUSTRY
Angeline Pantages. The community of computer manufacturers is an international one, with sufficient alliances and complications to make international politics look rather straightforward.

58 THE U.S. MULTINATIONALS
Angeline Pantages and Nancy Foy. The computer competition is often the least of their worries.

63 WESTERN EUROPE'S COMPUTER INDUSTRY
Angeline Pantages, Nancy Foy, and Andrew Lloyd. Propped by their governments, supported by the EEC, and tied to U.S. and multinationals, united they stumble and divided they often fall.

79 COMPUTERS FROM COMMUNIST COUNTRIES
Bohdan O. Szuprowicz. Removing the effects of national borders and capitalistic competition makes some things easier. Finding markets is not one of those things.

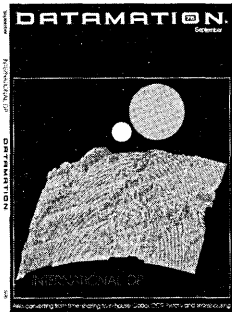

91 JAPAN'S COMPUTER INDUSTRY
Edward K. Yasaki and Angeline Pantages. They import the world's steel and send back Datsuns. Can they import enough technology to do the same with mainframes?

107 THE INTELLIGENT WAREHOUSE
James R. Benson. The ability to keep track of all goods at all times by computer allows for Levi Strauss' most accurate inventory control ever.

131 FRAGMENTS OF COMPUTER HISTORY
Edward K. Yasaki. The British Colossus, the German Z3, the Atlas, EDVAC, BINAC, and the Whirlwind—pieces of the past.

140 DECENTRALIZING DATA ENTRY WITH OCR
Dennis A. McMullen. Increased accuracy and reduced costs are the big results.

151 GOING CARDLESS
Vince Heiker. It sounds like heresy, but not even JCL should be on cards.

235 THE FORUM
Sander Rubin. The Computer Industry Association may not be right about a consent decree, but it's running the only game in town.

David M. Weiss. Those projections for public rapid transit systems are "blue sky" in more ways than one.

NEWS IN PERSPECTIVE

160 DISTRIBUTED PROCESSING
 It's a question of experience and 3½-day seminar in San Francisco shows that experience is lacking.

162 MEDICAL
 Computerized scanners: nearly all larger hospitals are prospects.

163 ELECTRONIC FUNDS TRANSFER
 Control Data tries to cash in on electronic funds transfer as do hundreds of others.

168 MAINFRAMERS
 Control Data is big in services—but also in systems.

168 RETAILING
 First it was the UPC. Now it's UP dollars.

171 SPACE EXPLORATION
 Viking's exploration of Mars: Impossible without computers.

172 COMMUNICATIONS
 Vendors and users lean to international packet-switched protocol.

176 TRAINING
 S/3 programmers anyone?

176 COMPANIES
 What's in a name?

178 CREDIT REPORTING
 Data on business now offered by TRW.

180 FINANCIAL
 There's a new financial world out there.

186 BENCHMARKS
 End of a dream; It's fair says the judge; Counterclaim filed; A week late, \$5 less; Canadian connection; A French connection; United buys Standard; Intel acquisition; Torrance re-ups; Mergers hold even; SDC orders from STC; New president at NCR; \$19 million sale; New name, place; Univac closes plant; Honeywell organizes group; New life at Stanford; Bright outlook.

DEPARTMENTS

7 LETTERS

13 PEOPLE
 C. H. "Pete" Link: hates a boring job; John Brackett: it was April 1; Robert Arthur: a business started by IBM.

17 LOOK AHEAD

22 CALENDAR

27 SOURCE DATA
 Harlan Mills on Dijkstra, and David Gardner on Malik, plus other books; reports, references, vendor literature.

55 EDITOR'S READOUT

204 HARDWARE
 A Tektronix-compatible graphics system, hybrid computing, communications buffer, interfaces.

216 SOFTWARE & SERVICES

Data security for IBM MVS users. Also, a teleprocessing monitor for PDP-11s, and an interesting data access tool.

225 MARKETPLACE

228 ADVERTISERS' INDEX

About the Cover

The international computing industry is changing everyone's view of the world. The isometric terrain height plot was produced by Warren Yogi and Howard Straus of Ocean Data Systems, Inc., Monterey, California, with the ODSI proprietary 3-D plot subroutines, using a Versatec raster plotter. Design is by Barbara Benson.

WHAT IS A DIGITIZER?

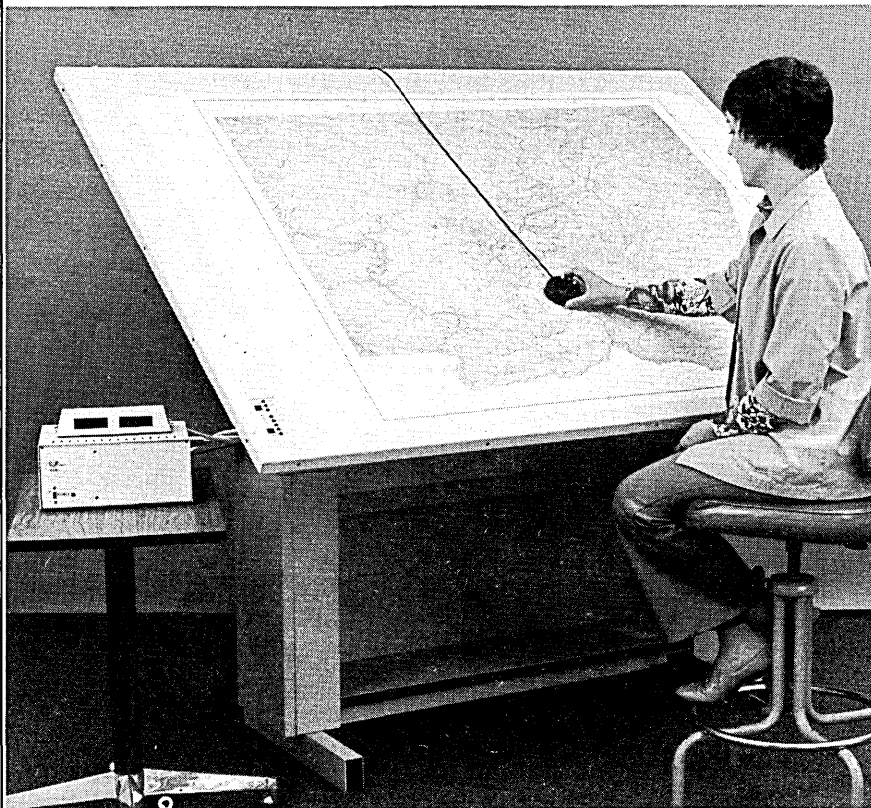

A digitizer converts, in a highly accurate manner, the position of a stylus or cursor on a graphic surface into a digital output suitable for communication, processing, and display.

Digitizers are sometimes called data tablets when used in lower accuracy applications. Higher accuracy applications in graphic systems include mapping and computer aided design.

Early digitizers (data tablets) used cumbersome mechanical arms and gears to determine coordinate points, while later digitizers employed sound transmission and even magnetic propagation.

These methods have been outdated by the introduction of the "Active Inch" digitizer by Talos Systems, Inc. The digitizer is so unique, it is called . . .

. . . CYBERGRAPH Truly a Digitizer

For more information on
THE DIGITIZER, contact:

*The Inventive
People*

TALOS SYSTEMS, INC.
CYBERGRAPH
7419 East Helm Drive
Scottsdale, AZ 85260
Phone: (602) 948-6540

DATAMATION.

EDITORIAL STAFF

Editor
Articles Editor
International Editor
European Editor
Industry Editor
Products Editor
Source Data Editor
Calendar Editor
News Editor
Bureau Managers
San Francisco
Los Angeles
New York
New England
Washington, D.C.
Correspondents
Minneapolis
Southwest
Australia
Editorial Advisor
Technical Advisor
Contributing Editors

John L. Kirkley
Richard A. McLaughlin
Angeline Pantages
Nancy Foy
W. David Gardner
Michael Cashman
Daniel P. Schlosky
Gloria Tidstrand
Tom McCusker

Edward K. Yasaki
Edith D. Myers
Angeline Pantages
W. David Gardner
Linda J. Flato

James K. Johnson
Robert F. Alexander
Ken McGregor
Robert L. Patrick
Lowell Amdahl
Paul Armer, Howard
Bromberg, Phillip H. Dorn,
Louis B. Marienthal,
Carl Reynolds
F. G. Withington

EDITORIAL OFFICES

Headquarters: 1801 S. La Cienega Blvd., Los Angeles, CA 90035. Phone (213) 559-5111. **Eastern:** 35 Mason St., Greenwich, CT 06830, (203) 661-5400. 134 Mt. Auburn St., Cambridge, Mass. 02138, (617) 354-2125; 6605 Burlington Pl., Springfield, VA 22152, (703) 569-3383. **Southwestern:** 2711 Cedar Springs, Dallas, TX 75201. (214) 744-0161. **Western:** 2680 Bayshore Frontage Rd., Suite 401, Mountain View, CA 94043, (415) 965-8222. **Foreign:** 8 Pellerin Rd., London N. 16; (01) 249-1177; 24 Stafford Road, Artarmon, Sydney, NSW 2064, Australia, 41-5748.

GRAPHIC DESIGN & PRODUCTION

Art & Production Director Cleve Marie Boutell
Advertising Production Manager Marilee Pitman
Production Assistant Alberta R. Martin

CIRCULATION

35 Mason Street, Greenwich, CT 06830
Circulation Manager Suzanne A. Ryan
Marketing Research Manager Deborah Dwellley
Publisher James M. Morris
Assistant Publisher F. Douglas De Carlo

Circulation audited
by Business Publications
Audit



Member



American
Business
Press, Inc.



DATAMATION is published monthly on or about the first day of every month by Technical

Publishing Company, 1301 South Grove Ave., Barrington, Illinois 60010; Arthur L. Rice, Jr., Chairman of the Board; James B. Tafel, President; Gardner F. Landon, Executive Vice President. Executive, Circulation and Advertising offices, 35 Mason Street, Greenwich, CT 06830, (203) 661-5400. Editorial offices, 1801 S. La Cienega Blvd., Los Angeles, CA 90035. Published at Chicago, Ill.

DATAMATION is circulated without charge by name and title to certain qualified individuals in the United States and Canada who are employed by companies involved with automatic information handling equipment. Available to others by subscription at the rate of \$24. Reduced rate for qualified students, \$14. Foreign subscriptions are available for £20.00 or for the equivalent of \$40 U.S. in most West European currencies. Sole agent for all subscriptions outside the U.S.A. and Canada is J. B. Tratsart, Ltd. 154 A Greenford Road, Harrow, Middlesex HA13QT, England. No subscription agency is authorized by us to solicit or take orders for subscriptions. Controlled circulations paid at Columbus, OH and Form 3579 to be sent to Technical Publishing Company, P.O. Box 2000, Greenwich, CT 06830. © Copyright 1976 Technical Publishing Company. ® "Datamation" registered trademark of Technical Publishing Company. Microfilm copies of **DATAMATION** may be obtained from University Microfilms, A Xerox Company, 300 No. Zeeb Road, Ann Arbor, Michigan 48106. Printed by Beslow Associates, Inc.

For Conversational On-Line Programming, Compare

ROSCOETM vs. TSO

COMPARE COSTS.

What does it really cost to install and operate an on-line system for program development? Terminals and other hardware costs are dwarfed by the cost of integrating and continuously operating the software. These expenses can exceed the savings resulting from improved turn-around and increased programmer productivity.

Carefully analyze the additional resources required to maintain an acceptable level of batch production when the on-line system is operating... larger CPU, more core, more direct-access devices. Dedicating an entire CPU to program development, as is usually done with TSO or VM/CMS, is a very expensive alternative to running production and development work concurrently on the same machine. A remote programming system should operate effectively in a multi-job environment, and maintain a high degree of terminal responsiveness without degrading background operations or reducing overall system throughput. ROSCOE does just that. But that's not all...

COMPARE FACILITIES.

By the time you pay for all the TSO facilities you need, ROSCOE will cost you far less. After paying to install TSO, you pay, and pay and pay. ROSCOE is far more cost-effective than TSO. And ROSCOE provides versatile services to applications and systems programmers, to operations, design, and clerical personnel. ROSCOE contains data entry and editing facilities, compressed self-reorganizing library storage and remote job entry and output retrieval functions. Plus... syntax checkers for JCL, COBOL, FORTRAN, and PL/1. Another unique capability of ROSCOE is its command procedure language which supports terminal I/O operations and includes decision making, branching, and iterative types of instructions.

You don't need another CPU to run ROSCOE. You don't need more memory or disks. Your daily batch production will not be reduced to a trickle. ROSCOE costs much, much less, in both direct and indirect costs. And, as is the case with all ADR software products, ROSCOE is fully field tested.

And proven in use for over six years at 360/370 sites all over the world. You, too, can benefit from ROSCOE. Just mail the coupon or contact one of ADR's offices.

APPLIED DATA RESEARCH, INC.

Software Products Division
Route 206 Center, Princeton, New Jersey 08540
Telephone: (609) 924-9100

Please send information on ROSCOETM

Name _____ Title _____

Company _____

Address _____

City _____ State _____ Zip _____

Telephone _____

Computer Configuration

I am also interested in

- MetaCOBOL[®] for increased productivity
- AUTOFLOW[®] II for maintenance and debugging
- The LIBRARIAN[®] for security and protection
- LOOK[™] for real-time performance measurement
- PI SORT[™] 2 for faster sorting



APPLIED DATA RESEARCH THE SOFTWARE BUILDERS[®]

ADR software products: in use at over 5,000 installations worldwide.

U.S. offices in Boston (617) 245-9540, Chicago (312) 694-2244, Cleveland (216) 228-0880, Houston (713) 526-3188, Los Angeles (213) 826-5527, New York (212) 986-4050, Pittsburgh (412) 885-2822, Princeton (609) 924-9100, Washington (703) 281-2011.
Foreign offices in Australia, Austria, Belgium, Brazil, Canada, Denmark, England, Finland, France, Israel, Italy, Japan, Korea, Mexico, Netherlands, New Zealand, Norway, Philippines, Puerto Rico, Republic of South Africa, Singapore, Spain, Sweden, Switzerland, Taiwan, Thailand, West Germany.

"We'll sell you the best, lowest priced 132-column printer available anywhere."

Bob Howard, President, Centronics



But the low initial price for the Centronics 700 Series 132-column printer isn't the whole story.

It's the lower cost of ownership based on the 700's inherent reliability and simplified construction.

The 700's unique modular construction using four different modules — printing, electronics, forms handling and keyboard — and less moving parts mean easier maintenance, lower cost and a smaller spares inventory.

Write for the full details of this tremendous offer . . . and information on the rest of the printers and teleprinters in the new Centronics 700 Series.

Centronics means more than low price.

And more than hardware. It's the widest range of models, features, options

- Financially strong
- Proven delivery response
- Over 70,000 printers installed
- 109 world-wide sales/service locations
- Stringent quality control
- Advanced R&D and manufacturing
- Long-term spare parts availability
- Customizing for specific needs.

CENTRONICS® IS PRINTERS

Centronics Data Computer Corp., Hudson, N.H. 03051, Tel. (603) 883-0111, Twx. 710-228-6505, Tlx. 94-3404; Eastern Region: (617) 272-8545 (MA); Central Region: (513) 294-0070, Twx. 810-459-1784 (OH); Western Region: (714) 979-6650, Twx. 910-595-1925 (CA) Centronics Data Computer (Canada) Ltd., Ontario, Tel. (603) 883-0111, Twx. 710-228-6505; Centronics Data Computer (UK) Ltd., Cheam, Surrey, England, Tel. 643 0821-4, Tlx. 851 945756; Centronics Data Computer, GmbH, 6 Frankfurt/Main., West Germany, Tel. 663321/22, Tlx. 841 413224; Centronics of Puerto Rico, Dorado, Puerto Rico, Tel. (809) 796-1881, Tlx. 3859349

letters

Language for communications

We were appreciative of the article "Compatibility or Chaos in Communications" by Sanders and Cerf (March, p. 50).

The implication for those installing or upgrading major computing installations is clear: they should specify X-25 and the associated standards as a necessary part of their system, if there is any intention to attach their installation to a network. If users make X-25 a tendering requirement, manufacturers and software houses will support it and public networks in all countries will adopt it.

Now that CCITT (International Telegraph and Telephone Consultative Committee) has formally adopted the X-25 protocol, the major unresolved problem area, as pointed out in the article, is the application level protocol. We cannot agree that the most serious aspect of this is that of terminals with idiosyncratic features. The aspect that



concerns us most is the lack of any standard for job control or commands for the interactive computing environment.

To make networks useful to programmers there is a clear and urgent need for a standard machine-independent command language. Such a language, if powerful enough, could by its own nature provide a complete application-level protocol (exclusive of terminal idiosyncrasies). Such a language needs to be sufficiently flexible to cope with all reasonable user requirements, sufficiently extensible to cope with unknown future requirements, and simple enough for any programmer to learn rapidly.

To those who believe that these three requirements are incompatible, we suggest they study SCL, the command language for ICL's 2900 series operating system. We are planning to use an SCL-compatible command language over an X-25-compatible

prototype network, initially linking Burroughs B6700's.

We are confident that SCL has the technical potential to become a standard if wide support can be found for it. We urge your readers to press their representatives on national and international standards organizations towards the adoption preferably of SCL, but certainly of some machine-independent command language.

C. R. BOSWELL, B. E. CARPENTER,
E. A. DRAWNEEK, K. HOPPER
*Computer Science Department
Massey University
Palmerston North, New Zealand*

R. M. GORDON
*Computing Services Centre
Victoria University of Wellington
Wellington, New Zealand*

Women—and men— as managers

I would like to express unqualified admiration for *Gonnie Siegel's June Forum*, "The Best Man for the Job May Be a Woman" (p. 196) . . .

I particularly appreciated Ms. Siegel's insight into the inner conflict in those who find that their emotions learn more slowly than their intellects. Her sympathetic recognition that learning to treat employees and applicants without regard to sex is a painful and slow process, is yet not inconsistent with her firm rejection of those who will not attempt to learn, or with her clear-eyed recognition of the stupendous amount of sex bias to be found at all levels of management.

MICHAEL W. HAM
*Director, General Systems
The American College
Testing Program
Iowa City, Iowa*

Ms. Siegel spoke eloquently of the business world's expectations concerning the characteristics which are supposed to lead to success. Business leaders, she reports, look for toughness, coolness, strength, ruthlessness—in short, qualities historically (and incorrectly, I think) associated with masculinity.

Whether or not such traits assure business success, I won't debate here, but my point is that it is not only women who are discriminated against by this "masculine" way of thinking. Many men who do not subscribe to this "business macho" are also passed over at promotion time. Ironically, men who excel in the more humanistic qualities such as warmth, empathy, and sensitivity, are thought incapable of managing people!

What course is left to the man in business who doesn't buy the conventional view of what constitutes a good businessman? He has two choices. He

can sublimate his natural humanistic tendencies in favor of his ambition, or he can reassess what is important to him and perhaps content himself with less of what is looked upon in the business world as "success." The first course cannot help but put a psychological strain on him, a strain which often pays off in ulcers, heart attacks, and other dysfunctions. In the long run, the second course is wiser, but often reveals itself too late in life, after much of the damage has been done and the behavior patterns have been set.

I applaud the women's movement and its leaders like Ms. Siegel. A second irony is that eventually men may profit from women's success. Maybe someday men who don't fit the mold of the "tough SOB" whom the business world so assiduously courts will be considered for the top spots along with their more "masculine" colleagues and with women. I think it would be good for everybody, including possibly business itself.

PETER MARTIN
Mountain Lakes, New Jersey

Compounding errors

Several readers brought to our attention an error made by management consultant Steven R. Levine in our July Forum ("Another Parker Game," p. 155). In presenting a tabulation of the sources of dp errors, Mr. Levine himself made an error (which we also missed) and ended up with a "total" of only 99.1%. The following should give the flavor of the reader response:

In reference to Mr. Levine's comment on Parker's game: What happened to the remaining 0.9%? Errors due to poor advice from management consultants?

GIO WIEDERHOLD
Woodside, California

Those long lines

The news article in your July issue reporting on the 1976 NCC (p. 98) refers to the attendees standing in line to register. It attributes the length of the lines to the use of plastic badges.

The system used is the same system used last year when NCC was held in Anaheim, under more favorable circumstances in every respect. And no problems arose there when the total attendance was only slightly less.

Stop watch test-timing indicated that making plastic badges took an average of one and one-half minutes each, versus one minute for paper badges. The plastic badge was not the problem.

The New York Coliseum was the first culprit. Its lobby is not large enough to accommodate sufficient equipment to handle such a large crowd. To compound the problem,

letters

another show (NEPCON) held in the same building on the same dates sent their attendees to the NCC registration area for badges.

A third problem had to do with the amount of data to be collected. As many as 130 to 150 characters of data per attendee had to be keyed to the computer tape for NCC record purposes.

Jacquard Registration Service has, over the past five years, handled conventions with registration as high as 95,000 without problems. The system has the capability and it should not be blamed for the length of the lines. After all, it is the only computerized registration system in existence today, and certainly a computer conference

should use computerized registration.

Furthermore, let's say those long lines may have been an indication of the health of the computer industry.

LARRY D. DALLEN

*Jacquard Registration Service
Long Beach, California*

Our Bicentennial Entry

You win the prize—and you were such an unlikely entrant! It's for the most completely asinine and tasteless grab-onto-the-Bicentennial-no-matter-what item in any medium. I refer to Jackson Granholm's "Great Moments in the History of Computing: December 12, 1777" (July, p. 71).

K. A. MOODY

Pittsburgh, Pennsylvania

Since essentially all the non-dp gags in Mr. Granholm's article were plagiarized from Stan Freberg's album, "The United States of America," I feel Fre-

berg should at least have been listed as coauthor.

WAYNE HATHAWAY
Sunnyvale, California

Mr. Granholm replies: This piece was actually done for a private, inebriated performance at a Digital Computer Assn. meeting. Whoever it is supposed to be patterned after should be insulted. Having been guilty of doing too many DCA programs already, I am doubtless guilty of making this effort as bad as possible. Why the editors of Big-D wanted it, I don't know, but there is no predicting editorial tastes.

Disputed origins

As regular readers of DATAMATION, we were surprised by the inaccuracy of comments made in the May issue (p. 182) referring to privacy and security in the Data Management Center, The Office of the Secretary, HEW. The facts are as follows:

(Continued on page 194)

Structured Cobol

The rules Dr. Mize states ("Structured Programming in COBOL," June p. 103) would allow orderly and modular code to be produced, but it would not be structured. In my judgment, this is caused by two facts being ignored or not understood.

1. One of the most beneficial aspects of top-down design is the natural separation of control structure from the functional doing in a program. The top level modules specify *what* has to be done and the conditions under which it is done. Lower level modules will accomplish the functional doing. This natural separation should be encouraged as it assists the designer since the problem has been parsed into two smaller problems—control and functional—and it assists the maintainability of the code since the novice reader of the program can concentrate first on the control structure and then on the functional doing. (Just try identifying the control structure and functional doing parts in a flowchart and you will see the advantages of top-down design.)

2. The second missing ingredient is the proper understanding of the purpose of the IF statement. The IF statement is quite different from the ADD, MOVE and READ verbs in that it does not, in itself, do anything toward solving the problem at hand except to determine the conditions under which certain other statements are to be executed. To understand a module, it is necessary to understand what it does, how it does it, and under what conditions it is entered. Often, multiple conditions must be met before certain modules are to be executed. For example, in a transac-

tion edit program, it may take dozens or hundreds of conditions to identify a valid transaction. Often the conditions are related. Often there are multiple sets of conditions which satisfy the requirements for the execution of a given module.

Consequently, Dr. Mize's rule on GO TO's is incorrect. GO TO's cannot be used to reexecute a module; that is control structure and belongs in a higher level module. Secondly, often it will take multiple IF statements (and compound conditionals) to identify the conditions which must be satisfied to execute certain modules. To hide the relationships of these conditionals by not allowing nesting, is detrimental to maintainability and readability; hence, the rule against nested IF's is incorrect. This is one place in which the original designer must sacrifice to achieve the goals of maintainability. The relationships of conditionals are vivid in the mind of

Professor Mize replies: Mr. Tucker's points are both valid and relevant. However, the intent of the article was to provide simple guidelines that would derive most of the benefits of structured programming without forcing unnatural structures on the COBOL language as it exists today.

If COBOL provided an in-line PERFORM option, I would agree completely with the total separation of the control and doing functions—not allowing any backward branching GO TO's. However, in COBOL, the control paragraph is physically separated from the doing paragraph. Prohibiting this use of the GO TO results in more communication flags or switches between paragraphs and in deeper nesting of PERFORM's. I admit that this use is a compromise, but no one has claimed that the control constructs in COBOL lend them-

the designer the day the code is generated, but unless those relationships are preserved in code, the maintenance task is increased. The nesting of IF statements must adhere to the rules of modular size; thus, modules of great IF-depth might need to be shortened to be comprehended.

These two rules are interrelated for if one cannot nest IF's, he must simulate with GO TO's. If GO TO's are restricted, nesting of IF's are necessary.

Modular code is good code. It prevents programs from being globally chaotic, and code that is only locally chaotic can be figured out. Structured code is modular, and additionally, it prevents code from being locally chaotic as well.

JAMES L. TUCKER
*Department of Public Administration
Department of the Army
U.S. Army Management
Engineering Training Agency
Rock Island, Illinois*

selves naturally to formal structured programming.

The article does not prohibit the use of compound conditional statements. The suggested discretion in the use of nested IF's is due to the confusion and necessary redundancies in nested IF's, since there is no ENDIF delimiter to mark the scope of the logic to be invoked under various combinations of circumstances. Used properly nested IF's can reduce the fragmentation of the program and the levels of PERFORM's required. However, their use opens a Pandora's Box for the bugs and modification headaches to begin creeping in.

Hopefully, someday soon the programming language to allow the natural writing of structured programs for business applications will be available and compromises such as these will no longer be necessary. ❄

UCC-FCS

THIS IS THE GENERAL LEDGER SYSTEM YOU AND YOUR ACCOUNTING DEPARTMENT HAVE BEEN DREAMING OF.

* Here's exactly what will happen when you call. One of our staff will take your name and address and immediately send you a brochure explaining exactly what the UCC General Ledger/Financial Control System is all about. (In Texas, call 214-638-5880 collect.)

When you've seen how UCC-FCS meets your financial reporting requirements, call this number again. We'll arrange a presentation at your convenience.

Here are some reasons why UCC-FCS has made

the Accounting and Data Processing Departments happy in over 150 IBM 360/370 or mid-size Burroughs installations.

- Quick and efficient implementation.
- Easy-to-use report writer requiring virtually no EDP assistance.
- Full general ledger accounting, *plus* budgeting, costing, profit center reporting. And much more.
- Optionally generates *over* 100 standard reports.

UCC

We're going to
be the IBM of *software*
companies.

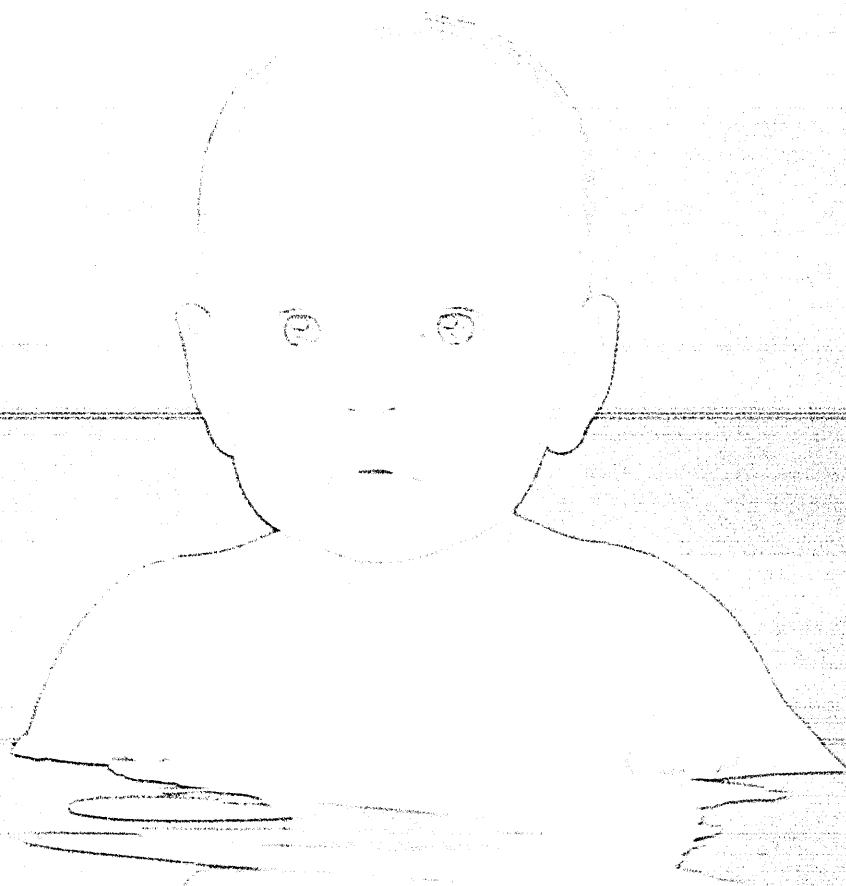

The emergence of a new thinking machine.

The SEL 32/35.

**Twice the power for half
the price.**

If your computing needs could be answered by such machines as Data General's Eclipse, or DEC's PDP 11 series or Interdata's 7/32, consider the SEL 32/35.

Rather than get into bits and bytes, there's really only one thing you need to know about the SEL 32/35: You get two to four times the power for every "compute" dollar spent. Period.

That's a pretty powerful statement. But the SEL 32/35 is a very powerful machine.

Extra power can go a long way to maintain the balance you need in your computer system, so essential for reliable, peak performance.

And extra power, for fewer dollars, can do wonders when you're trying to balance a corporate budget.

For more information about the new arrival in our family of computers, just circle our number on the Reader Service Card. Or, for faster action, call us direct.

Either way, we'll see that you get all the vital statistics on our new baby.

SYSTEMS
ENGINEERING LABORATORIES

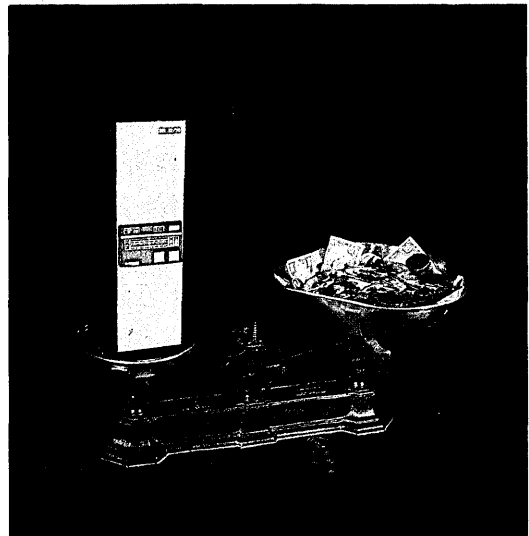

6901 West Sunrise Boulevard
Fort Lauderdale, Florida 33313
(305) 587-2900

informatics
informatique
informatics

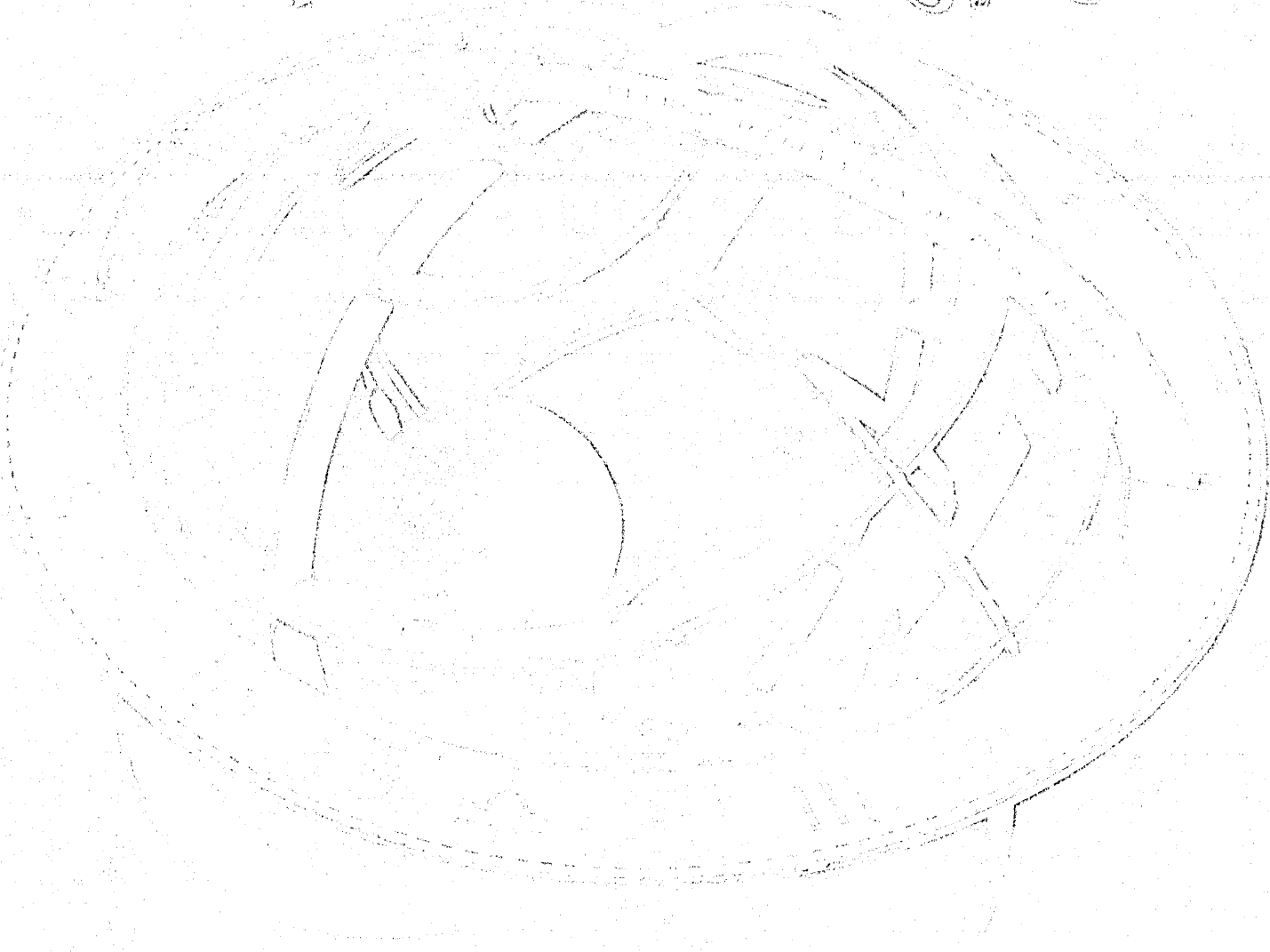

Wherever it's said, however it's spelled,
informatics fulfills the promise
of the computer... universally!

Informatics... the word is synonymous throughout the world with the ultimate in modern data processing. In the United States and many other countries it means the people, products and services of Informatics Inc. One of Informatics' many product families... INTERCOMM, BETACOMM and MINICOMM teleprocessing monitors. Transaction control and processing, for simple on-line systems up to total communication and task scheduling systems. Informatics Inc., the world's leading independent supplier of software products, with over 2,000 installations in 42 countries... helping to fulfill the computer's promise.

Corporate Offices/21031 Ventura Boulevard/Woodland Hills, California 91364/(213) 887-9040/Telex 69-8473

SOFTWARE PRODUCTS
PROFESSIONAL SERVICES
INFORMATION PROCESSING SERVICES

informatics inc

ENTER 10

Informatics is a U.S. registered service mark and trademark of Informatics, Inc.

CIRCLE 30 ON READER CARD

people

Computer Aided Manufacturing

C. H. "Pete" Link hates a bofing job. "It seems I've worked at a little bit of everything," said Link, who has toiled in such diverse areas as accounting, pattern making, carpentry and welding. But as soon as the challenge in each job left, so did Link.

This seemingly innate desire for leaping high vocational hurdles is no doubt what will keep the 47 year old manager indefinitely content at his current job as executive secretary and general manager of Computer Aided Manufacturing—International, Inc. in Arlington, Texas. He has held this job since CAM-I was formed in 1972.

As the chief paid officer of CAM-I, Link said he has the opportunity to organize a new international association of industrial, governmental and educational groups for the joint development of computer aided manufacturing applications. This position makes Link responsible for the legal and financial dealings of the non-profit corporation as well as for administering its eight-member staff, international representatives and contractors.

Since CAM-I concentrates on software development, Link said he deals with some of the most intelligent and productive innovators in this field from each of CAM-I's 91 member companies in North America, Western Europe and Japan. Therefore, one of the most demanding challenges of his job is staying current with the rapid changes in the computer industry.

Link said he does this mainly by reading a lot of books while in flight to meetings throughout the world. "I spend about six weeks each year in jets," he added, "and this gives me time to read 40 to 50 books, mostly concerning my work."

Computer aided manufacturing, Link noted, is often misdefined as a factory with machinery totally controlled by computers. "I think the term has been a little overused and people tend to think that it means eliminating the workers," he said. "That's not my view at all."

Studies show the major inefficiencies in manufacturing are not found in the employees who operate machinery, but rather develop from the lengths of time raw materials must sit idle, said Link.

"Ninety-five per cent of the time a product is in a factory is spent in waiting to be worked on," he noted. "So the most important aspect of controlling factory production is not automating the equipment, but rather controlling the flow of information on the production floor.

"For at least 15 years there have been adequate simulation systems for management to use in attempting to schedule production," he continued. "But one of the biggest problems with these is that once the majority of the information has been simulated, the plan deteriorates in practice. It reports what has happened after the fact. No one has yet developed a system where manufacturing could be practically monitored on the factory floor."

Controlling this information as it happens is what CAM-I is trying to do with programs such as CAM-I Automated Process Planning (CAPP), Link contends. "By cutting down the waiting time by 10, 15 or 20 per cent you reduce the large investment in inventory, shorten the lead time for production and keep costs competitive."

Link said he expects automated planning systems will be available during 1977 to generate production schedules for machined and sheet-metal parts, castings and forgings as well as for electrical components and assemblies. By 1978 he sees advanced automated planning in use by large companies, with medium and small manufacturers joining by 1980. Link anticipates the use of minicomputers dedicated to line and management

functions in a hierarchical structure by 1985.

To help prepare himself for this international growth of automated process planning, Link is studying the spoken languages of many of the industrial countries where he expects these development to occur. For instance, he already knows enough German and Italian "to get by" and he is currently studying Japanese with the assistance of a portable cassette player.

Despite his computer-age schedule, Link plans in time to spend with his wife, Marilyn, and their two sons,



C. H. "PETE" LINK
"... The term has been misused."

Peter Michael, 5, and Jameson Todd, 1. Link said he also tries to spend several hours each month picking out bluegrass tunes on his guitar in duet with a banjo-playing friend. It's breaks like these that no doubt keep him refreshed for the challenge of his work.

April Fool's Appointment

John Brackett could have been excused if he thought that it was all a practical joke when the president of his company—SofTech, Inc.—resigned, and he was appointed to replace him. The date was April 1.

But Cornelius Peterson was serious about leaving to pursue personal busi-



JOHN BRACKETT
He didn't get an M.B.A.

ness interests, and SofTech's Board meant it when they named the 38 year old Brackett president.

The appointment of Brackett was not a complete surprise. He had served in key technical management posts for the Boston-area firm since joining founder Doug Ross and three others in forming SofTech in 1969.

And as early as his senior high school year, he had surprised a CalTech recruiter by announcing his plan to follow up a B.S. degree in chemistry with an M.B.A.

That plan never quite worked out. He didn't go to CalTech, and he didn't get an M.B.A. Instead, after getting his bachelor's in chemistry at MIT, he went on to get a Ph.D. in physical chemistry from Purdue. During that time he became deeply involved in the use of computers, then returned to MIT where he worked on Project MAC (Multi-Access Computer) for five years.

And he got what might be called on-the-job management training at SofTech by "looking over the shoulders of

people

Doug Ross and Pete Peterson for seven-plus years." He also headed up several large projects for sophisticated customers. One friend, unimpressed, asked him, "What is a guy with a Ph.D. in chemistry who spent five years at MIT, doing running a software company?"

Brackett, who grins a lot, laughed. Then he got serious. "A technical man such as myself can only manage an enterprise if it has a sound management structure and able, experienced financial and marketing management. Thanks to Pete and Doug, SofTech has just that."

One of Brackett's first moves as president was to name Justus F. Lowe, Jr., treasurer and chief financial officer. Lowe, who *does* have an M.B.A. (from the Harvard B School), served as general manager of two divisions of Control Data Corp. before joining SofTech in 1973. He will continue to serve as general manager of the Federal Systems Div. of the firm.

Brackett also feels that technical management is important in a company that deals, as does SofTech, at the leading technical edge of the industry. Finally, he feels, "One soon learns what it is important to ask of the com-

pany's business executives. If you ask the right questions, you learn a lot of interesting things. If you ask the wrong questions, you don't learn anything."

How does Brackett—an internationally recognized authority on computer graphics, software engineering, and structured programming—hope to manage a company *and* keep abreast of his specialties?

He plans to spend one-third of his time being directly involved in SofTech's contract work. "That's billable time." He'll also attend conferences and read.

Brackett is not a narrow specialist. He has a broad view of industry trends and needs . . . and of SofTech's role in matching them.

The overwhelming problem in large companies right now, he feels, is the development of the incredibly complex systems that are critical to an organization's profitability and to its ability to function in the face of continually changing requirements.

"A lot of systems shouldn't be built with more than 10 people," he says, "but many can't be built with that few. And the new software engineering and programming productivity techniques come into their own—pay big dividends—on big systems requiring big teams."

It's clear that although he was appointed president on April 1st, John Brackett is no fool.

Control Data, which reduced 30 million pages of IBM documents to about a million selected indexes and abstracts on microfilm and tape in their suit against the giant, began selling the system on its Cybernet network a few months after the suit was settled out of court in January, 1973. It has been profitable ever since, says Arthur. The key to its success, he once said, "is cross referencing. When lawyers use manual filing systems in complex cases, they only can cross reference evidence on one or two subjects. With the computer, we have the capability to index and cross reference evidence by a virtually infinite number of subjects."

"We are a dedicated sweat shop," said Arthur of his 40-man organization. Law is like the church and medicine. "The mass starts at 11 a.m. The operation begins at 2 p.m. And the court convenes at 10. Lawyers haven't the time to have a service say to them, 'give us another 48 hours and we'll have the bugs out. It must be available now.'

"A lot of people have dabbled in trying to provide computer services for lawyers and have failed," says Arthur. Their failure is due "to having only provided a small piece of the spectrum." As an example, he notes that in a recent case involving several law firms, Control Data will field a crew of 600 part-time persons to collect and analyze 250 million pages of documents. It's much like a construction job where there's a convulsion of people, later replaced by a handful doing maintenance. Maintenance can go on for several months or years, he says.

Arthur, a tall balding man with the stern countenance of a judge and whose diction betrays signs of his British heritage, isn't a lawyer. He's an Oxford trained historian (American history) who later became a market researcher with the Gallup organization. He joined Control Data in 1965 as a market researcher for CDC's Data Centers Div. when CDC acquired Computek, a New York service bureau which specialized in market research. He was on the CDC corporate marketing staff in the late '60s when CDC asked him to start building a data base to support its attorneys in the IBM antitrust suit that it filed in 1968.

Since the January 1973 settlement, the system has been enhanced so that it "doesn't offer pre-packaged standard solutions that may limit the attorney's options." Among the enhancements is MRI Systems Corp.'s System 2000 data management system and a series of statistical and other information retrieval systems. These are five or six other firms offering computer services to lawyers and Arthur envisions these services as a "multi million dollar" business before too long. *

Litigation Service Built for IBM

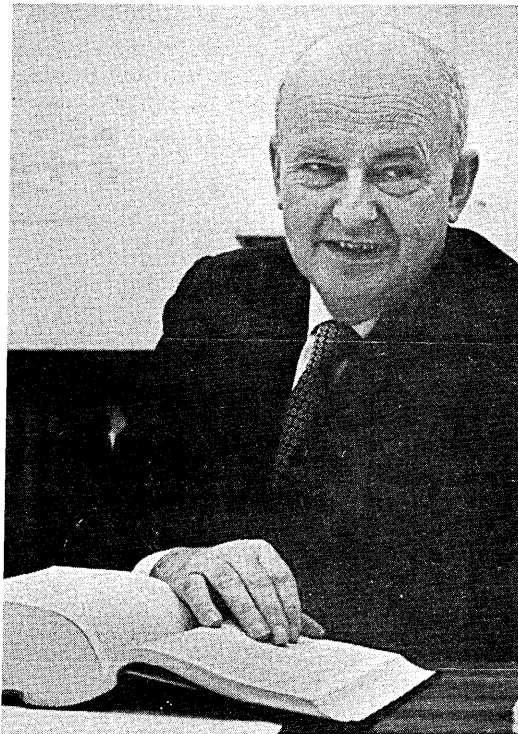

ROBERT S. ARTHUR
Computer is a necessity in many of today's large suits

In its celebrated antitrust settlement with International Business Machines Corp., Control Data Corp. destroyed 10 tons of documents as part of the out-of-court agreement. But it retained the method in which it organized the data base. Now, a 40-person organization within CDC is marketing an improved version of its legal preparation service and in the past three years has provided it to some 50 large clients involved in big antitrust, patents and civil rights suits.

The head of the organization selling the service, Robert S. Arthur, general manager of Information Services, says computer services for lawyers in large suits almost is a necessity today. "Lawyers tell me today that 10 years ago using a computer service in support of complex massive civil litigation would have provided a unique advantage against the adversary. Today it merely would keep it even." That is because in the U.S. the volume of litigation is increasing exponentially, says Arthur, and the computer industry is being dragged into the business, providing such things as text storage and retrieval of documents, abstracts of the documents and indexing capability.

BRIGHT, REFRESHING, BAUDY, AND NEW IN TOWN.

What a beauty!

The new OMRON 8030 CRT Terminal is the one you've been dreaming about. It has an 8080 IQ—smart enough for the most demanding applications, 9600 Baud, and multiple page refresh memory. And wait 'til you see the other features!

It's a very classy package for a very reasonable figure. Get properly introduced by OMRON.

Call or write for all the specifications to:
OMRON Corporation of America
Information Products Division
432 Toyama Drive, Sunnyvale,
California 94086 (408) 734-8400

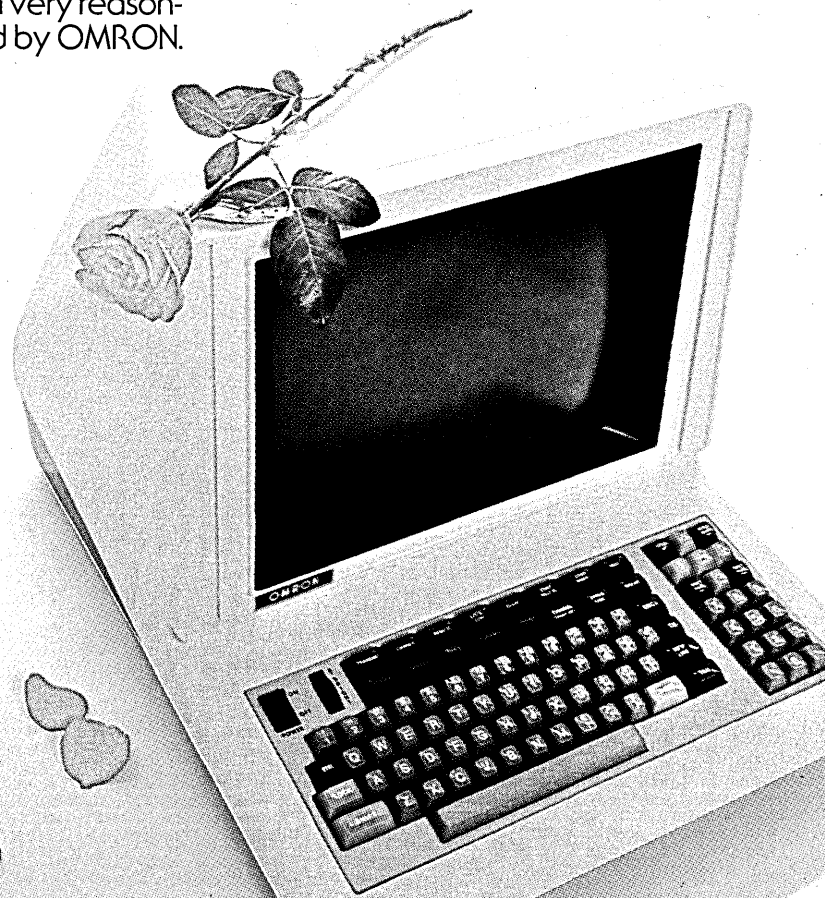

CIRCLE 64 ON READER CARD

For OEM & Distributor pricing information contact OMRON, Sunnyvale, CA. Offices: OMRON CORPORATION OF AMERICA - Oxon Hill, Md. (301) 248-2150; Englewood Cliffs, N.J., (201) 871-3460. OMRON Europe GmbH, Hamburger Strasse 11, 2 Hamburg 76, West Germany, TWX 841/213-403+. OMRON Tateisi Electronics Co., Tokyo, TWX 246-6813 and Kyoto, TWX 542-2889.



Your mother needs help.

At one time, people were willing to wait around for your big computer to get around to them.

No more.

Now they're demanding more work, faster than your mother can possibly do it.

Which has put you in a rather difficult position. You've either had to put them off, or put your mother through an upgrade so expensive it's unreal.

Neither of which you have to do any more. Because now you can get your mother a little help. A computer that can do the jobs she's too busy to do.

An ECLIPSE C/300.

The C/300 is smaller than the big computers you may be used to using. But it has the things big computers have. A comprehensive commercial instruction set that even has an EDIT function, for example. And large memory configurations.

The C/300 also has an incredibly sophisticated data management system with multilevel keyed access called INFOS. It supports the languages anyone could ever want: COBOL, RPG II, Real-

time FORTRAN. And INFOS runs under RDOS, our real-time multitasking operating system.

And the C/300 has intercomputer communications ability that lets you interface to your mother. Directly via channel connect, or via communication lines so it can emulate 2780's or HASP. Or be itself. And, wherever you put an ECLIPSE C/300 you can hang terminals off it with synchronous or asynchronous lines.

The COBOL that comes with the C/300 is the highest level implementation of ANSI 74 COBOL standards. It's a complete language system that comes with features like an interactive debugger. And an integrated SORT/MERGE.

And you can get all your peripherals at Data General. Because Data General has all kinds of discs, tape drives and printers. In all sizes. Discs for example, come in anything from a floppy to 3330-type 90 megabyte drives.

Write for more information.

That way, you'll be able to spend more time with your mother. Because you'll be spending less time making up excuses.



ECLIPSE C/300: BECAUSE YOUR MOTHER NEEDS A LITTLE HELP.

Data General

INFOS is a trademark of Data General Corporation. ECLIPSE is a registered trademark of Data General Corporation.

• Data General, Route 9, Southboro, Mass. 01772 (617) 485-9100. Data General (Canada) Ltd., Ontario.
Data General Europe, 15 Rue Le Sueur, Paris 75116, France. Data General Australia, Melbourne (03) 82-1361/Sydney (02) 908-1366.

CIRCLE 48 ON READER CARD

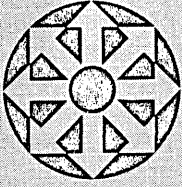

LOOK AHEAD

\$4,000 PRECEDENT?

It took four years of litigation to do it but Commerce Union Bank in Tennessee is due for a \$4,000 rebate of sales taxes it paid from 1968 to 1971 on standardized software packages it purchased. The publication, "Computer Law and Tax Report," says the Tennessee Supreme Court, in what may be a precedent setting decision, upheld the bank's contention that neither operational programs nor applications programs acquire by a user from a software house are tangible personal property and therefore cannot be taxed under the state's sales and use tax law. Most states impose sales and/or use taxes on all software, including California, which three years ago set another precedent of a sort by passing legislation banning personal property taxes on all software except "basic operational programs."

SOVIET KAMA RIVER ORDER INCLUDES 3330s

IBM is getting ready to install that big 370/158 at the Soviet Union's Kama River truck foundry plant. Three System 7s are already installed, we hear. More important however, is the fact that the configuration is to include several 3330s. While the Russians' attempts at making mainframes through its Ryad series have been getting off the ground in recent months, the Soviets are still stymied in their efforts to make sophisticated peripherals so the 3330s may be of great significance to them. Many believe the Kama River installation will be the biggest computer configuration in the Soviet Union.

UNANNOUNCED LINE TO BECOME PART OF JAPAN'S M SERIES

Japan's Hitachi-Fujitsu computer development combine is understood to be adding its lower-end "V" series of machines to the Fujitsu M series line. The unannounced line originally was to have been the V 1, 2 and 3 series (see chart on page 100). Now, we hear, they'll be called the M-130, M-140 and M-150 and compete with IBM's 370/115, 125 and 135. High end of the line are the M-160 to M-190, the latter billed as an even more powerful version of 470 V/6 made by the Amdahl Corp. in which Fujitsu has a 30% interest.

Word from Fujitsu, by the way, is that the Japanese company which sells Amdahl equipment overseas, has orders for 55 of the Amdahl machines.

ONE SMALL STEP

Crocker National Bank in California is taking the "educate the consumer" route to Electronic Funds Transfer (EFT). It will install unmanned IBM transaction terminals in all of its branches within this year which will allow consumers to use plastic cards to access their account balances. Presumably, when the bank feels this harmless transaction has been mastered, consumers will be permitted to go to bigger and better things on the terminals like deposits, withdrawals and transfers.

16 BIT FREE-FOR-ALL

Already a free-wheeling business, the 16-bit microprocessor market looks increasingly like a free-for-all these days. Intel and National Semiconductor have design teams hard at work on new 16-bit devices that should compete with the 9900 16-bit entry already being delivered by another semiconductor firm, Texas Instruments. Data General is expected to begin shipping its Micronova this fall and Hewlett-Packard is understood to be designing a new machine utilizing silicon-on-sapphire technology. The big question mark is represented by Digital Equipment Corp. DEC's LSI-11 has been something of a bomb so far and the firm is up to its eyeballs in equipment it's picked up from trouble-plagued Western Digital, which had been producing the machine for DEC.

The LSI-11 is now being produced by DEC in limited quantities at its Worcester, Mass., semiconductor facility. Some DEC users have been complaining that the LSI-11 is too slow and is difficult to program. The betting is that DEC will soon have a new model that will remedy those problems and, further, that the new machine will be one chip replacing the current machine which has four chips.

THREE YEAR UPGRADE FALLS SHORT IN TWO

California's Department of Motor Vehicles, storm center in a controversial procurement of equipment for the state's first consolidated data center, the Stephen P. Teale center, has saturated its data processing capacity despite a "temporary upgrade" of its Univac equipment in mid-1974 that was supposed to keep it going for three years.

LOOK AHEAD

At the time of the upgrade authorization, which saw Univac's revenue from DMV go from \$2.5 million a year to some \$4.5 million, state assemblyman Mike Cullen called failure of DMV to go to the Teale center, "a multimillion dollar ripoff" of California taxpayers. Now, going to Teale is one of the alternatives DMV is looking at in a feasibility study it hopes to complete by the end of November.

Marge Lucy, data processing director for DMV, said a study done for the department by Comten Inc. showed that it is "quite saturated." The department is running three Univac 70/6s and a Univac 7055 as a front end. Its implementation of staggered vehicle renewal, handled on-line, is to the tune of 50,000 transactions per day. And now DMV has the state's recently passed Parking Citation Bill (SB 192) to contend with. This involves issuing outstanding parking citations with each vehicle registration renewal notice (the tickets must be paid before the license is renewed).

DMV has to implement this by Jan. 1, 1978. Lucy said it will mean adding 203 terminals in field offices. This requirement definitely will be put out for bid and it seems likely the undercapacity requirement will too. The Teale center, reportedly, already is running 3,000 jobs per day. During the procurement storm, in which DMV conversion was pivotal because the date for staggered renewal implementation had to be guaranteed by the vendor (eventually IBM which didn't make the date), state officials were predicting 3,000 jobs per day by this time, including DMV.

JUSTICE BENEFITS FROM E.Z. MILLION

One reason the Justice Dept.'s effort against IBM may be showing more zing in recent months is the presence on the government's staff of a man with the unlikely name of E. Z. Million. A former IBMer, who later served as a dp consultant at the Air Force in the Pentagon, Million has been providing the government's legal team with expertise on the computer industry and on uses of computers for the past few months. Million, who is understood to be serving on a temporary assignment, operates a computer consulting business in Norman, Okla.

- - -

Meanwhile, the Telex-IBM case just won't stay dead. The outside attorneys who represented Telex in the litigation are pursuing legal action against Telex. IBM possibly could be drawn into the action and what's most intriguing of all is that the litigation could reveal the details of how the case was settled in IBM's favor at the eleventh hour before it was slated to go before the U.S. Supreme Court.

HONEYWELL UNDER A SHARP PENCIL

McKinsey & Co. is close to wrapping up a top secret "overhead value analysis" for Honeywell. This kind of consulting job normally leads to cutbacks and our intelligence tells us the current McKinsey study will be no exception. The big target should be HIS' general and administrative functions particularly in its North American operations headquarters in Waltham, Mass., although Minneapolis and Phoenix should be hit too. Marketing probably will be safe from this chopping.

THE VOICE WITH A SMILE?

A new company in Marina del Rey, Calif., Delphi Communications, Inc., is quietly readying a system which could revolutionize the telephone answering service business. The company is developing, and implementing on a pilot basis in San Francisco, a computer-based telephone-answering system with voice response, which supposedly will be considerably cheaper than the human versions. Officials of the company are reluctant to talk about what they are doing except that "we are a privately held company." It's understood, though, the firm has the cooperation of AT&T and some financial backing from Exxon.

AMDAHL USERS DON'T QUALIFY FOR SHARE

The IBM user group, SHARE, turned thumbs down at its August meeting on allowing Amdahl computer users to become members. The Amdahl users argued that anyone using IBM software as well as hardware should be allowed in. (Amdahl's 470 V/6 uses IBM software.) The majority felt, however, that without IBM hardware, the software users don't qualify for membership. Some opponents felt that other companies, like Control Data, would also demand entry, but what really was at stake among SHARE members was the quality of IBM support for the organization. "IBM is subtle," said one. "It

(Continued on page 190)

IMSAI 8080: THE COMPLETE COMPUTER SYSTEM

- Computer with 16K bytes of memory, 8-level interrupt and interval clock
- 2 floppy disk drives with intelligent interface/controller
- 300 LPM printer
- 24-line by 80-column CRT with keyboard
- Programmer's front panel and software
- All peripherals interfaced

\$10,493 UNIT PRICE*

**Quantity discounts available.*

IMSAI 8080: THE COMPLETE DEVELOPMENT SYSTEM

- Computer with 16K bytes of memory, 8-level interrupt and interval clock
- 2 floppy disk drives with intelligent interface/controller
- 2 serial I/O RS232 or TTY ports
- Chassis with 22 card slots
- Power supply, programmer's front panel and software

\$5,856 UNIT PRICE*

**Unassembled \$4,444. Quantity discounts available.*

The IMSAI 8080 Floppy Disk System. It's more than you'd expect for much less.

The IMSAI 8080 Intelligent Floppy Disk System. For the money, there's no development system like it: it's easier to use, more powerful, modular and versatile than anything on the market. And the tickets prove it.

The IMSAI 8080 computer is powerful, accommodating up to 64K bytes of MOS write-protect memory. It's fast, with 500 nanoseconds total memory access time and 2 microseconds minimum instruction time.

The IMSAI 8080 is modular and highly versatile. It can accommodate up to 22 boards. And there's no restriction on mix of memory and I/O interface boards.

The IMSAI 8080 can be configured for just about any application. We offer a variety of memories (RAM and EPROM), I/O interfaces (parallel, serial asynchronous and synchronous RS232C, TTY), peripherals (disks, printers, tape

cassette, CRT's), and multiprocessing capability.

And if you're an OEM, you'll like the way the IMSAI 8080 is put together. Switches are large and rugged, and the front panel, with hexadecimal and octal notation, has an extra eight program controlled LED's.

The intelligent floppy disk interface/controller has its own processor and firmware. It provides sophisticated control of the

floppy disk system with DMA and automatic retry. And this economical interface/controller can handle up to four drives. Each disk stores up to 243K bytes using the IBM 3740 format and has an average access time of 330 milliseconds.

You can immediately develop your own application software using DOS, assembler, text editor and debugger. In addition, extended BASIC and FORTRAN, both integrated with DOS, will soon be available.

The IMSAI 8080 Intelligent Floppy Disk System. Never before could you get so much for so little. For an IMSAI 8080 catalog describing options, peripherals, software, specifications and prices, write or call IMSAI.

Dealer inquiries invited.

IMSAI

IMS Associates, Inc.
14860 Wicks Blvd.,
San Leandro, CA 94577
(415) 483-2093

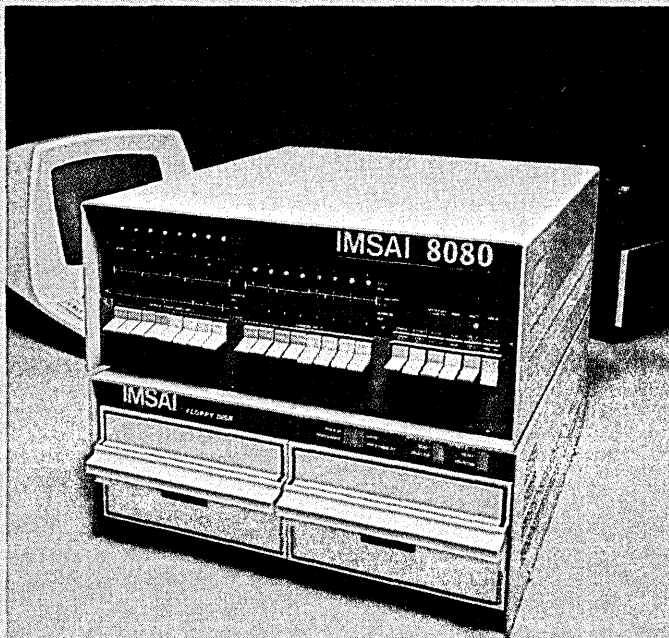

Bankers agree: Fujitsu means on-line.

Dai-Ichi Kangyo Bank (DKB) is Japan's leading bank; *American Banker* ranks it eighth in the world. Six years ago DKB's officers asked us to help build an integrated banking network uniting the head office and its 310 branches.

We responded with a powerful central processing complex and a wide array of financial terminals. Soon, management was getting the nation-wide pulse on day-to-day operations. Branch managers were able to process loans against a central data base.

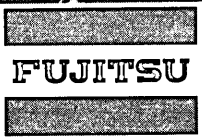

MAIN PRODUCTS □ Electronic Computers □ Peripheral Equipment □ Telegraph & Data Communication Equipment □ Remote Control

And customers? They are now making more and more deposits, transferring funds electronically, repaying loans, and making after-hours withdrawals by banking card from strategically located on-line "cash dispenser" terminals.

The success of this system has led to bigger and tougher job assignments...such as the Extended Data Communications System for Nation-Wide Banking Business that ties in 7,400 branches of 87 different banks into one huge, fast, reliable network.

Bankers do agree that Fujitsu means on-line.

Why us? Because Fujitsu has the muscle and skill to solve just about any data communications problem. We're a leading main-frame maker whose line spans everything from micro to very large scale computers. We're one of the world's biggest suppliers of telecommunications equipment of all kinds.

And we're uniquely experienced in meshing the two into tailor-made data communications systems.

When you want your business to go on-line, drop a line to Fujitsu.

FUJITSU LIMITED

Communications and Electronics
Tokyo, Japan

CIRCLE 30 ON READER CARD



calendar

SEPTEMBER

8th Annual International Micrographic Congress, Sept. 28-30, Stockholm. This conference will feature seminars on information handling in government, standards, engineering documentation, retrieval systems, and high speed filming, among others. Other application areas will include transportation, education, banking, health care, financing, accounting, and manufacturing. Fee: U.S. \$161 (approx.). Contact: Gustav Bujkovsky, IMC, P.O. Box 484, Del Mar, Calif. 92014, (714) 453-8112, or Programme Committee, IMC 76, Box 5512 S-11485, Stockholm, Sweden.

OCTOBER

Electronic Computing Health Oriented Conference, Oct. 3-6, Los Angeles. The fall meeting of ECHO, which is comprised of more than 550 hospitals and other health care oriented institutions, will concentrate on the applications of computer technology to benefit these services. Fee: \$85, individual and associate member; \$100, nonmember guests of members. Contact: Bill Russell, UCLA Univ. Hospital and Clinics, Los Angeles, Calif. 90024, (213) 825-7576.

Computer-Assisted Test Construction Conference, Oct. 11-13, Chicago. This is the third in a series of annual events on the construction of conventional tests through the use of computers. The content includes a discussion of item banks, statistics, classification, administrative considerations and exchanging information. Fee: \$35. Contact: CATC Conference, 960 Grove St., Evanston, Ill. 60201, (312) 869-7700.

1976 Biennial Display Conference, Oct. 12-14, New York. The IEEE, Society for Information Display, and the Advisory Group on Electron Devices are sponsors of this event, which concentrates on research and development of electronic display devices and systems. Invited papers will be presented on cathode ray tubes, electroluminescent displays, light emitting diodes, liquid crystal displays, and plasma displays. Fees: \$35, members; \$40, nonmembers; add \$5 after Oct. 1. Contact: Thomas Henion, Palisades Inst., 201 Varick St., New York, N.Y. 10014.

Euromicro, Oct. 12-14, Venice. This second symposium on micro architecture of computer systems (the first was held in Nice in 1975) will feature papers and discussions on microprogramming and microprocessor systems. An industrial exhibition will be held, and equipment will be demonstrated. A tutorial on Oct. 11 on bit slice microprocessor systems will feature detailed concepts and techniques of design. Fees (approx): \$140, Euromicro members; \$154, nonmembers; \$72, students. Tutorial fee: approx. \$145. Contact: Second Euromicro Symposium, Dr. Pierre LeBeaux, UTC, BP 233, 60206 Compiègne, France.

National Micrographics Assn. Mid-year Meeting, Oct. 13-15, Denver. The program will emphasize unique applications of micrographic techniques for information management in business, government and industry. Discussions will include computer output microfilm, color microfiche for self instruction, and micropublishing in professional journals. Fee: \$95, member; \$120, nonmember. Contact: Conference Director, NMA, 8728 Colesville Rd., Silver Spring, Md. 20910.

Micro and Minicomputer Equipment Exhibition, Oct. 12-15, Frankfurt, Germany. Sponsored by the U.S. Dept. of Commerce, this exhibit is expected to attract 2,000 representatives from Germany, Austria, Switzerland, France, and the United Kingdom to the U.S. Trade Center. Contact: Dwight L. Umstead, U.S. Dept. of Commerce, Ofc. of Int'l. Marketing, (202) 377-2177/4414.

On-Line Systems, Oct. 18-20; Data Base Systems, Oct. 20-22, San Francisco. These government-industry conferences are presented by the American Institute of Industrial Engineers. The first meeting will cover impact of miniaturization, hardware configuration trends, and new software techniques and services. Data Base Systems will concentrate on the special problems in design and administration. Fees (single conference): \$295, teams \$195; both conferences: \$445, teams \$330. Contact: Dept. DTM, AIEE Seminars, P.O. Box 25116, Los Angeles, Calif. 90025 (213) 826-7572.

Assn. for Computing Machinery Annual Conference, Oct. 20-22, Houston. ACM '76 will feature panel discussions, tutorials, and special papers by the special interest groups. Sample titles include operating systems for minicomputers, data base design, multinational information systems, prospects and problems with electronic funds transfer systems, and operating system command languages. Interpreting services will be available for the deaf. A two-day workshop on computer graphics on Oct. 18 and 19 is directed to purchasers of graphics equipment, managers of graphics projects, and others interested in the topic. There will be an exhibit of minicomputers and technical books. The 7th U.S. Computer Chess Championship will be held Oct. 19-21 in conjunction with the conference. Conference fees: \$45, member; \$70, nonmember (\$25 of this may be applied to the membership fee); \$10, student. After Sept. 20 add \$10 for nonstudent registration. Contact: ACM '76, P.O. Box 6703, Houston, Texas 77005, (212) 265-6300.

DPMA Info/Expo 76, Oct. 24-27, Las Vegas. This 25th anniversary conference of the Data Processing Management Assn. will feature 50 seminar sessions by dp experts. In addition, one of the eight sessions on "Issues of Impact" will include an update on the privacy issue. Seminar topics include how to cost and charge for dp services, long range planning, data base administration, and dp career paths. Fee (includes meals and all special events): \$150, member; \$190, nonmember. Contact: DPMA, 505 Busse Hwy., Park Ridge, Ill. 60068, (312) 825-8124.

CALL FOR PAPERS

IEEE International Solid State Circuits Conference, Feb. 16-18, 1977, Philadelphia. Papers on design, performance, testing or application of solid state circuits and systems are solicited for presentation at this forum. North American authors should send 20 copies of both a 35 word program abstract and a 300 to 500 word review summary by Oct. 4 to Lewis Winner, 152 W. 42nd St., New York, N.Y. 10036 (212) 279-3125. A limited number of post-deadline papers will be considered.

ON THE AGENDA . . .

IEEE Eascon '76, Sept. 26-29, Arlington, Va. 10th Annual Conference, Canadian Micrographic Society, Oct. 13-15, Toronto. (416) 534-9511, Ext. 772.

Conference information submitted to Calendar should include registration fees, phone number and name of contact. Items for consideration should be received by DATAMATION three months prior to the event.

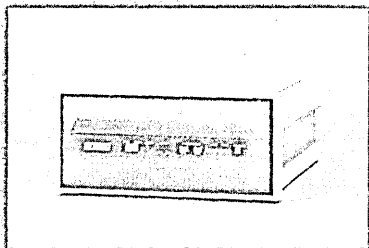

When you buy a Series 400 disk drive in 26.6, 40 or 53.6 megabyte capacity, you get two drives in one compact package! The first has a removable 13.3 Mbyte cartridge, and the second has 13.3, 26.6 or 40 Mbytes of fixed capacity. It's only possible with our exclusive inertial actuator that gives our Series 400 drives two independent head positioners. That means you can be reading or writing with the upper unit, seeking with the lower unit. And, of course, all the inherent Series 400 features are there: power interrupt protection, data track servo following, common dimensions for all models, 100% common spares, interface compatibility in all models and proven Diablo disk drive performance dependability and reliability. For a complete presentation of the new Diablo Series 400 disk drive family, call or write Diablo Systems, Inc., 24500 Industrial Blvd., Hayward, CA 94545 or Diablo Systems, S.A., Avenue de l'Étoile, 269, 1130 Brussels, Belgium.



Diablo Systems, Incorporated
A Xerox Company

2 disk drives for the price of one

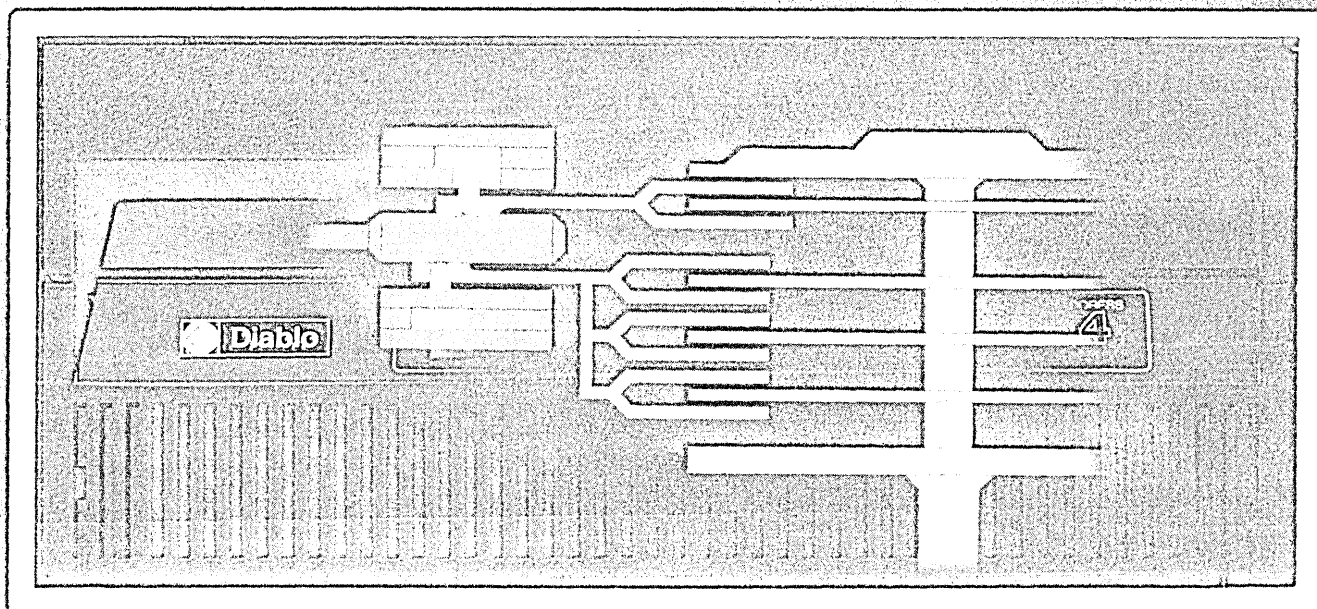

XEROX is a trademark of XEROX CORPORATION.
Diablo and DTA type are trademarks.

CIRCLE 52 ON READER CARD

When it comes to computer networks, MODCOMP offers you a big advantage.

Experience.

At MODCOMP, we were pioneers in making the concept of resource-sharing computer networks a practical reality. The tying together of multiple computers in distributed processing systems whereby several computers work together, sharing the work load.

Putting the computing power out where the work is, yet allowing each computer in the network to do not only its own job, but also draw upon the resources of every other computer in the system.

We developed MAXNET as a standardized operating system exclusively for this purpose. And MODCOMP systems using our network software have been in operation for more than two years.

We now have over forty network systems in the field, with another fifteen or so being readied for early delivery. Which means that we have more experience—both in length of time and in numbers of systems installed—than all our competitors combined.



In addition to traditional "host-satellite" networks, we have systems in operation that include so-called "ring" networks, "star" networks, and many more. The important thing is that you can link your computers together in any format you want. Provide each computer with whatever peripherals are best suited to your purpose. And leave the rest to MAXNET.

We figure the best way to give you an idea of what MAXNET can do is to give you some examples showing how other people are now using it.

We invite you to study these case histories. More important, we invite you to get in touch with us so you can get a first-hand look at how well

they work. Which is a lot more convincing than just listening to us brag about them.

Meanwhile, we have a couple of brochures you should send for.

Our MAXNET brochure deals with computer networking, and how MAXNET makes it all happen.

The other is a thirty-two page booklet that explains in detail exactly what we mean by MODCOMP "TSP." The Total Systems Performance that has made MODCOMP first choice of many of the world's toughest computer buyers.

If you're into computers at all, the TSP brochure is "must" reading. If you're into resource-sharing networks (and if you're not, you soon will be), the MAXNET brochure is equally compulsory.

Write Modular Computer Systems, 1650 West McNab Road, Ft. Lauderdale, FL 33309. Phone (305) 974-1380.

European Headquarters:
Export House, Woking,
Surrey, England
Phone (04862) 71471

Case History No. 1

A giant aluminum company chose MODCOMP for this simple two-computer "network."

Computer A is at one of the Company's plants in Pennsylvania. Computer B at a research facility in Tennessee, several hundred miles away. The two computers communicate with each other over ordinary dial-up telephone lines. Using MAXNET, operators at either location have full access to all the resources of both computers. Data, programs, peripheral services can be freely exchanged.

For example, suppose a research engineer at Computer B needs to compile a new program. By a simple terminal request, he can call down language processors from Computer A, compile and edit his program on his own computer, and transmit his listing outputs back to Computer A for printing.

Alternatively, a programmer at Computer A can prepare a program and load it directly down to Computer B. Even though it's the break of day in Tennessee, and the computer is all alone in the office.

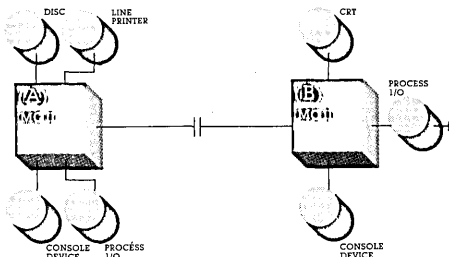

This relatively simple system illustrates the flexibility of MAXNET, whether the computers in your network are in adjoining rooms, or a thousand miles apart. It would work just as well if they were on different planets, but nobody's asked us to do that. Yet.

Case History No. 2

This MODCOMP Network is in operation at the central R&D facility of a major oil company. It's a good example of how MAXNET, coupled with across-the-board compatibility of MODCOMP hardware, allows you to start as small as you want to, and grow as big as you need to. Without a heavy initial investment. And without costly re-programming as your system expands.

It started, as part of a long-range plan, with the installation over two years ago of a MODCOMP III. Although this model has now been superseded in our line by later

models of the MODCOMP II, it is indicative of the long-term compatibility of MODCOMP systems that the III remains today a vital part of this network.

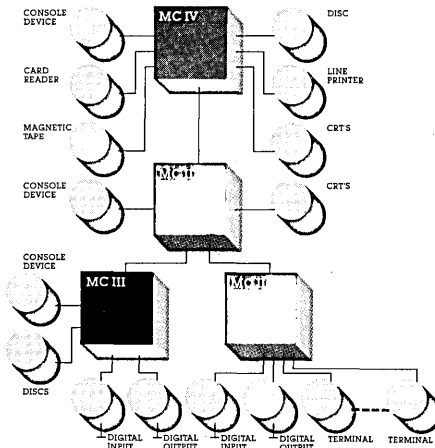

As the system has since evolved, a 32-bit MODCOMP IV now acts as host computer. Replacing (at a fraction of the cost) the company's former stand alone IBM 1800, the MODCOMP IV is expected to provide 10 to 25 times the throughput of the big machine, which had long since reached its saturation point.

A MODCOMP II acts as communications controller between the host and satellite computers.

The satellites consist of 16-bit MODCOMP II's performing various data acquisition and control functions for a series of pilot plants. The MODCOMP III handles analytical instrumentation, providing simultaneous service to over 80 instruments of various types.

The advantages of this system are, firstly, it's computing power—many times that of the old stand-alone system. It's reliability (the MODCOMP system has had an overall availability of 99.3% of prime time over the past two years). It's expandability, which allows virtually unlimited future growth. And last, but far from least, it's economy and ease of operation.

Case History No. 3

A NASA prime contractor has installed this highly sophisticated MODCOMP hierarchical network to handle complex stress and fatigue test analyses.

Dual redundant 32-bit MODCOMP IV's at the "host" level communicate with an intermediate level of several smaller 32-bit MODCOMP IV's, screening data received from the satellite computers. A large number of 16-bit MODCOMP II satellites interface directly to the various processes. The entire system has built-in redundancy at each level.

Among minicomputer vendors, only MODCOMP has the capability to build a network of this size and complexity, using standard hardware and software products. At a small fraction of the cost for a single stand-alone computer large enough to perform the same multiple tasks. And with far greater efficiency.

It clearly illustrates the unlimited expandability of MAXNET in setting up any kind of network system you need to do your particular job.

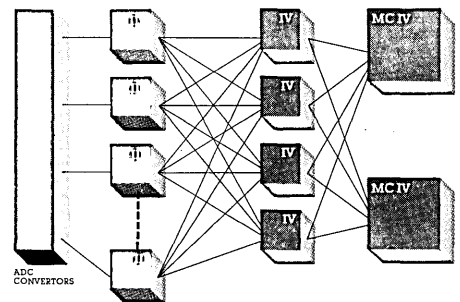

For clarity, peripheral devices omitted from this diagram.

Note: The MAXNET systems shown here are all resource-sharing networks of the type commonly used in laboratory and industrial measurement and control systems. For dedicated telecommunications applications, MODCOMP offers a separate software system called MAXCOM. For more information, send for our Data Communications brochure.

MODCOMP TSP*

*TSP=Total Systems Performance.

MODCOMP SALES OFFICES: ALBUQUERQUE, NM/ATLANTA, GA/BOSTON, MA/CHICAGO, IL/CINCINNATI, OH/DALLAS, TX/DENVER, CO/DETROIT, MI/HOUSTON, TX/HUNTSVILLE, AL/INDIANAPOLIS, IN/KANSAS CITY, KS/LOS ANGELES, CA/MONTREAL, CN/NEW YORK, NY/ORLANDO, FL/PHILADELPHIA, PA/PITTSBURGH, PA/ROCHESTER, NY/SAN JOSE, CA/SEATTLE, WA/WASHINGTON, DC/INTERNATIONAL OFFICES OR REPRESENTATIVES IN ENGLAND/France/BENELUX/WEST GERMANY/NORWAY/SWEDEN/JAPAN.

A better way to communicate.

Let's face some hard business facts. If your company is using terminals on your IBM 360/370, you are using very expensive processing power to perform very slow applications.

As a result, you haven't been able to afford to develop new applications without upgrading or expanding. Both costly. And time consuming. But there's a unique new answer now. From Varian.

It's called PRONTO (Programmable Network Telecommunications Operating System). And it will help you make more efficient use of your network of terminals. It can help you off-load your IBM. And it will provide you with local processing capabilities.

It works like this. Your mainframe thinks PRONTO is a cluster of 3270's. Your terminals think PRONTO is your mainframe. And PRONTO allows you the flexibility of using TSO, IMS, CICS or any other communications package from a single undedicated terminal.

Our Varian System can be installed on a phased basis without interrupting your current work flow. It allows you to utilize any of the common computer languages such as COBOL, FORTRAN or RPG II. And it allows you to use TOTAL, the most widely used data base management system in the nation.

If you'd like to learn to communicate better, just call one of our worldwide offices, or write Varian Data Machines, 2722 Michelson Dr., P.O. Box C-19504, Irvine, Ca.

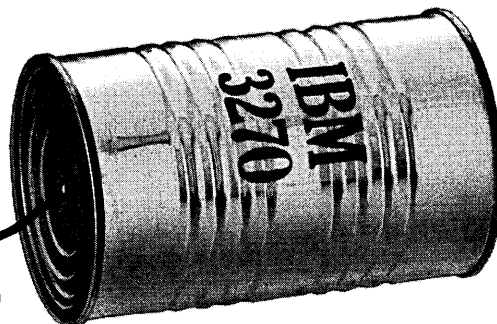

92713, (714) 833-2400. In Europe, contact Varian Associates, Ltd., Molesey Road, Walton-on-Thames, Surrey, England, Telephone 28971. Our free brochure will show you why more and more companies are finding out that a Varian computer system with PRONTO makes good business sense.



Helping a Fast World Move Faster

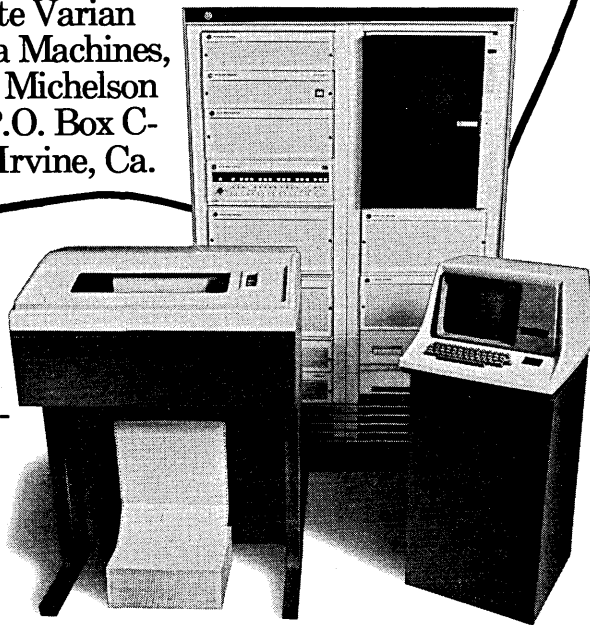

U.S. OFFICES: Los Angeles (213) 598-4438, San Diego (714) 276-9462, San Francisco (408) 736-5630, Seattle (206) 641-4500, Denver (303) 770-2151, Dallas (214) 231-5145, Houston (713) 781-0105, St. Louis (314) 739-6433, Chicago (312) 692-7184, Detroit (313) 645-9950, Cleveland (216) 238-6960, Orlando (305) 299-1592, Atlanta (404) 252-0047, Washington, D.C. (301) 773-6670, Philadelphia (215) 643-2355, New York City (212) 325-5248, Rochester (716) 586-3273, Boston (617) 890-6072.
INTERNATIONAL OFFICES: Brussels (02) 4662000, Darmstadt (06151) 86386, Munchen (089) 8126093, Bensberg (02204) 61066, Amsterdam (020) 15 94 10, Stockholm (08) 820030, Zug (042) 23 25 75, Surrey 093 22 28971, Toronto, (416) 457-4130, Montreal (514) 332-2840, Vancouver (604) 736-5621, Ottawa (613) 224-6521, Calgary (403) 276-4456, Melbourne 560-7133, Sydney 43-0673, Sao Paulo (011) 240-3449, Singapore 2352602, Tokyo 403-7101, New Zealand 697-099, Taipei 559082.

source data

SOURCE DATA provides information on books, courses, references, reports, periodicals, and vendor publications.

books

A Discipline of Programming

by Edsger W. Dijkstra
Prentice-Hall, 1976
217 pp. \$14.95

This is an important book which will have a profound and lasting influence on programming methodology. It is difficult reading, but it deals with a difficult subject. And it will spawn any number of new books on programming in further explanation and elaboration over the next decade.

There are 28 chapters (numbered 0 through 27) which are addressed to the following topics:

0-6, Introduction and Basic Theory (44 pages)

7-8, Applications to Elementary Problems (27 pages)

9-12, More Theory (35 pages)

13-23, Applications to More Substantial Problems (61 pages)

24-25, Author's Selftest on Substantial Problems (33 pages)

26-27, Reflections and Conclusion (17 pages)

The book is addressed to the experienced programmer with a good background in mathematical logic. It will be especially valuable for those who would teach programming as a deep and challenging intellectual process. The material represents a tight distillation of ideas over a lifetime of one of the deepest thinkers in programming today. There are simply more ideas and more depth than can be understood at one reading, or even in one course. It may require considerable effort to revamp one's own mental framework to understand Professor Dijkstra's ideas. But it will be a lifelong experience for those who do.

At the heart of the book is a constructive approach to program correctness through which programs are derived systematically from their requirements. A central idea is a so-called "predicate transformer," which views a program as a description of how a final predicate (of logical requirements on data at program termination) is transformed into the widest initial predicate (on data at program initiation)—i.e., the program itself is the predicate

transformer. The objective is to begin with the final requirements, and then derive a program to satisfy them. A related idea is nondeterminacy in program execution. It turns out, surprisingly enough, that nondeterminacy makes the derivation of correct programs simpler in some cases.

As a consequence of his main ideas, Professor Dijkstra introduces a language of deep and elegant simplicity for expressing program design. He derives the semantics of this language by a step by step analysis of predicate transformers, beginning with two unusual, but important, statements, which are immediately suggested by simple instances of predicate transformers, namely *skip* (a statement that does nothing) and *abort* (a statement that fails to do anything, i.e., does not even do nothing). (These statements may seem whimsical at first, but there are important uses for them later, as special cases for more complex statements.) Then, he derives the ordinary assignment statement and ordinary sequences of statements as natural further extensions of predicate transformers.

So far, these are only more elegant derivations and deeper understandings of familiar programming ideas. But

A landmark in programming methodology . . . the basis for a whole generation of more effective programmers.

surprises of a profound nature are in store next, in branching and looping statements. In preparation, Professor Dijkstra defines a new concept, called a *guarded command*, namely a predicate (the guard) followed by a sequence of one or more statements. Then he defines two new statements called *IF* and *DO*, each of which are specified by an unordered set of guarded commands.

In executing the *IF* statement, the guarded commands are examined in random order, and the first enabled command found, if any (i.e., command with predicate guard evaluating true), is executed (i.e., its sequence of statements is executed). Otherwise, if there is no enabled command, the *IF* statement reduces to the *abort* statement (i.e., fails to terminate).

In the *DO* statement, the guarded commands are examined in random order, and the first enabled command, if any, is executed, and the guarded

commands are again examined in random order (independently of the previous order), etc., repeatedly until, if ever, no guarded command is enabled, whence execution is terminated. Notice, if no guarded command is enabled at the outset, then the *DO* statement reduces to the *skip* statement.

The usual *ifthenelse* and *whiledo* statements of structured programming are special cases of the *IF* and *DO* statements of Dijkstra. An *IF* statement with exactly two guarded commands with guards which are logical complements corresponds to the *ifthenelse*. A *DO* statement with a single guarded command corresponds to the *whiledo* (the guard serves as the *whiletest*).

But the surprise in more general *IF* and *DO* statements is the possibility of indeterminacy when more than one command is enabled. At first glance such indeterminacy would seem to introduce unnecessary complexity. In fact, it reduces the need to specify unnecessary sequencing, which is a form of unnecessary complexity itself.

In illustration, the problem of assigning the maximum value of x or y to z is given in classical terms:

Classical

```
if  $x \geq y$ 
  then  $z := x$ 
  else  $z := y$ 
fi
```

and in Dijkstra's language:

Dijkstra—I

```
if
   $x \geq y \rightarrow z := x$  □
   $y > x \rightarrow z := y$ 
fi
```

The expression $x \geq y \rightarrow z := x$ is a guarded command with guard $x \geq y$ and sequence of one assignment statement $z := x$ (z "becomes" x). The heavy bar \square separates guarded commands.

The guards ($x \geq y$, $y > x$) are logical complements above, and provide the same control logic as the classical *ifthenelse*. But Dijkstra goes on to observe a more symmetric form with the same function

Dijkstra—II

```
if
   $x \geq y \rightarrow z := x$  □
   $y \geq x \rightarrow z := y$ 
fi
```

in which the guards have a common intersection ($x = y$). In this case there is a nondeterminacy as to which of the assignments ($z := x$ or $z := y$) is to be executed; but, of course, both lead to the same correct result (when $x = y$). So the nondeterminacy does not destroy correctness, but does not require an unnecessary choice in this case.

20 million microfiche in 4 years.

Four of the hardest working Bruning duplicators we know of belong to Disclosure, Inc., in Bethesda, Maryland. In their mainstream business, this micro publishing firm produces quantity fiche copies from documents filed by companies with the Securities and Exchange Commission.

Three Bruning OP40s and an OP49, each with an automatic collator, produce 4 to 5 million fiche duplicates a year; or, 20 million

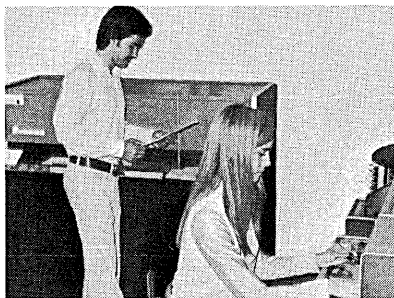

in 4 years. That's about *double* the industry's average output from high-speed fiche duplicators. During peak seasons the units produce over one million duplicates per month.

Now, if you're thinking about a microfiche duplicator for your operation, all we ask is that you consider Bruning's proven capacity for endless hard work in making your buying decision.

Contact your local Bruning office for more information. Or write Bruning, 1834 Walden Office Square, Schaumburg, Illinois 60172.

The bold force in micrographics.



BRUNING

DIVISION OF
® ADDRESSOGRAPH MULTIGRAPH

source data

Chapter 15, "Updating a Sequential File," will be of special interest to business programmers. It deals with the classical problem of creating a new sorted master file from an old sorted master and a sorted transaction file, with all the usual complications possible—a mixed sequence of transactions with updates, deletions, and insertions. Perhaps of most interest is that the resulting program is not markedly different in character from other programs in the book dealing with seemingly more logical or scientific problems. The notation may appear formidable to a COBOL or PL/1 programmer, to be sure, but more because of unfamiliarity than because of complexity, because the logic has been reduced to bedrock simplicity.

Chapter 24, "The Problem of the Convex Hull in Three Dimensions," is an author's self-test, in which Professor Dijkstra designs a program for a problem new to him in front of the reader's eyes. In it we see the problem solver at work—the false starts (and even more important, a recognition rather than defense of them), and the pleasant surprises (that a concept or principle did more than was expected of it). It is

a significant problem solved by the method of stepwise refinement, which not only demonstrates the feasibility of the method, but also demonstrates the ruthless self-criticism required in correct program design, even of a master programmer. This chapter, alone, would require a short course to do it justice and comprehend its lessons, even with the basic theory and language conventions already understood.

A Discipline of Programming is a landmark in programming methodology. The unity and power of the theoretical ideas will be the basis for many textbooks in explanation and elaboration over the next decade, and for a whole generation of more effective programmers. The work is a rich source of insights, large and small. But the principal insight is summed up in the final chapter, "In Retrospect," in the form of two "messages":

"The first message is that it does not suffice to design a mechanism (program) of which we hope it will meet its requirements, but that we must design it in such a form that we can convince ourselves—and anyone else for that matter—that it will, indeed, meet its requirements. And, therefore, instead of first designing the program and then trying to prove its correctness, we develop correctness proof and program hand in hand. . . . The second

message is that, if this constructive approach to the problem of program correctness is to be our plan, we had better see to it that the intellectual labour involved does not exceed our limited powers . . ."

For these insights—for putting the horse before the cart, and for recognizing and showing how to cope with our own human limitations—we owe Professor Dijkstra much gratitude.

—Harlan D. Mills

Dr. Mills has made important contributions to structured programming and chief programmer team concepts. An author of several books and articles, he is an IBM Fellow at IBM's Federal Systems Div., Gaithersburg, Md.

And Tomorrow the World? Inside IBM
by Rex Malik
Millington, Ltd., London, 1975 (Distributed in the U.S. by the Computer Industry Assn., 1911 N. Fort Meyer Dr., Rosslyn, Va. 22209)
496 pp. \$15

There beats in the heart of contemporary man a growing desire to believe in a new kind of fairy tale that can be explained in terms of modern science and technology. Perhaps it is because the new fairy tales bring us back our uncomplicated childhoods. Whatever the reason, the stories are illogical—like "Rumpelstiltskin"—but that is the allure. Science and technology will make them happen.

**Our
line.**

source data

And so, the Loch Ness Monster lives, there is life in space and on Mars, and there are flying saucers too; the Bermuda Triangle can be dangerous to our health if we fly or sail into it; heart transplants work; and, of course, computers think.

The state, the press, and the scientific and academic community all expend great sums of money, time, and

... the book drips with animosity for IBM.

effort pursuing these fairy tales each year so we can believe in them a little more. Moreover, the pursuit grows each year, suggesting that the desire is becoming a necessity. The Loch Ness Monster has been photographed; another ship has gone down in the Bermuda Triangle; a pig's heart beats in a man for a day or two in Houston; a formation of flying saucers has been sighted in Michigan; there is a new breakthrough in Artificial Intelligence.

Strangely, the people and the institutions that have brought us the real science and technology that touches us elicit little or no interest. It is as though there is a conspiracy to avoid

the real world by focussing on myths.

Rex Malik, however, has been on the trail of the real world of IBM. The London-based journalist has been covering the IBM story for years, and the title of his book, taken from Nazi Germany's Lebensraum thrust, gives us a hint even before we open the covers that Malik may not have approached his subject with a completely open mind. Inside, the book drips with animosity for IBM.

Malik takes us on a trip through the various IBM lawsuits, mixing a dash here of industry history with a dash there of IBM executive personality. Malik's greatest accomplishment is that he had the gumption to try. The subject is one of gargantuan difficulty, made so by a combination of IBM's traditional secrecy, its complexity, and the fact that Malik has had to be first to blaze the trail.*

There is a shrill and unrelenting intensity to the book, and the author speaks in his dedication page of "what drove me to write this."

The many and varied lawsuits against IBM have dredged up a bo-

*[Ed. note: *Think: A Biography of the Watsons and IBM* by William Rodgers, *The Sun Never Sets on IBM* by Nancy Foy (Datamation European editor), and *The U. S. Computer Industry: A Study of Market Power* by Gerald W. Brock, are, among others, considered more limited in scope.]

nanza of IBM internal documents—documents that give an unprecedented look at the inner workings of a huge multinational corporation. Malik has made poor use of the documents, many of which, standing alone, make for fascinating reading. Only a few are identified and quoted from, although it is possible the author used the documents extensively in forming his strong opinions on IBM—to what extent we will never know, however, since *Tomorrow the World* contains few footnotes and no explanation on the documentation.

Malik says he interviewed many IBMers and former IBMers, but these are not identified by name or rank. Did Malik interview Tom Watson at his skihouse at Stowe, or did he interview the janitorial staff at Armonk? The latter probably, given the book's lack of a ring of authority.

Like all good journalists, Malik looks for accuracy in others; he makes much of the time *Business Week* spelled Frank Cary's name wrong on its cover. Yet, Malik talks of IBM's June (*sic*) Cahill and U.S. Supreme Court Justice Byron "Buzzer" (*sic*) White, when, of course, he should have written Jane and Whizzer. Small points, maybe, but ones that tend to reflect on the accuracy of the entire book. Throughout the book, long quotes

CFI 1316 Series Disk Packs

The beginning of the line. Proven and field-tested. Designed for use with IBM 2311, Singer System 10 and CDC equipment, among others. CIRCLE 93 ON READER CARD

CFI 3336 Series Disk Packs

Largest product in the line, in both size and storage capacity. First disk pack to use servo track control. Available in two versions. Model 1—100 megabytes, Model 11—200 megabytes. Configurations available for CDC, Honeywell, NCR, DEC and Data General, among others. CIRCLE 94 ON READER CARD

CFI 2316 Series Disk Packs

The most versatile product in the line. Available in many different sector configurations, data densities and track densities. Compatible with all major disk drives, including the Univac 8440. CIRCLE 95 ON READER CARD

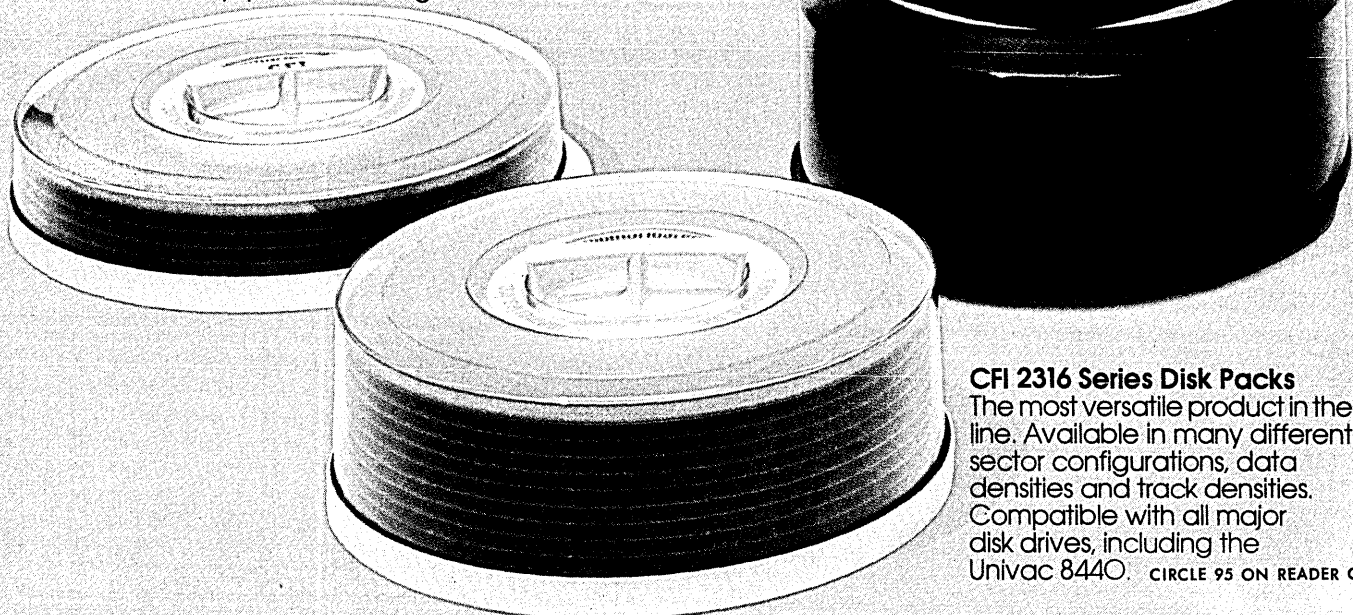

from unidentified sources (the Armonk janitors again?) float about like balloons at a country fair. Often they knife this or that IBM executive. We learned, for instance, that former IBM chairman T. Vincent Learson was called "Attila the Hun"—but not by whom—and that Learson's "get tough" policies on the PCM's may have caused Thomas J. Watson Jr.'s heart attack. This may come as news to Mr. Watson, Mr. Learson, and others.

IBM executives do not need defense, nor do they need blind attack—they need exposing. Who are they? What makes them tick? What makes IBM tick? IBM has contributed major pieces to every industrialized nation's central nervous system. Pick your area—com-

IBM executives do not need defense, nor do they need blind attack—they need exposing.

puters, communications, transportation—IBM is usually at or near the center. Yet the men behind the company remain a mystery. The company gave signs of entering a period of openness since the reign of the younger Watson, and that fact, combined with the court documents, should mean that we can find out *something* about IBM. But Malik tells us little, or

little that we can rely on. Could he find no one willing to speak out at length for the record? Some, no doubt, will say that IBM has gotten the book that its secrecy deserved.

There are other irritants. *And Tomorrow the World* smacks of European computer chauvinism and might well have carried the subtitle: "How the Mean Americans Stole from the Great European Computer Geniuses."

Babbage, Turing, and Zuse are the author's heroes, and one receives the feeling that the Hungarian von Neumann might have made the Malik team if he had settled in England rather than the U.S. Malik, too, believes that IBM instituted a serious sales effort in Russia because of the competitive threat from England's ICL. The chauvinism continually gets in the way of fact.

Yet, for all that is irritating, there are some fine points in the book. Malik's analysis of the 360 generation, questioning whether it was a gamble—as is the popular version—is an original and thought-provoking piece of work. In addition, Malik has a way of dropping tidbits and nuggets of interesting fact and opinion throughout the scattered landscape of the book.

More than anything, though, Malik's book will be read because it is the only game in town. Malik has been

the only one to write broadly and focus directly on the IBM computer era in nonacademic terms. Malik is an explorer, but he is not Sir Francis Drake the explorer; he is Mr. Magoo the explorer, staggering blindly from court case to court case, from executive to executive, occasionally cockeyed but occasionally striking home too. But alas, even after this book, we still know more about the Loch Ness Monster than we do about IBM.

—W. David Gardner
Mr. Gardner, Datamation's Industry Editor, is a close watcher of IBM.

BOOK BRIEFS . . .

Artist and Computer
Ruth Leavitt, ed.
Creative Computing Press, P.O. Box 789-M, Morristown, N.J. 07960 (1976)
132 pp. \$10.95 (\$4.95 paperback)

Although some artists have used the computer to produce finished pieces of artwork, many simply prefer to use the computer as an "idea machine." In this attractively illustrated volume, 35 artists from the U.S., Canada, England, Europe, and Japan, explain how they discovered the possibilities offered by the computer—from visualizing fabric before it is actually woven, to using a color tv monitor attached to a computer to produce paintings.

CFI Trident Disk Packs/Storage Module

The newest products in the line. Uses 3336-11 particle-oriented disk. Available for use with all Trident-type drives having storage capacities of 25, 50 and 80 megabytes. Also available in storage module configurations for CDC and Hewlett/Packard type drives. CIRCLE 96 ON READER CARD



CFI 5440 and 2315 Series' Disk Cartridges

The most popular products in the line. CFI Memories is the world's largest supplier of disk cartridges. We make them in every version, compatible with every computer and peripheral manufacturer. They're available in 100 TPI, 200 TPI and 400 TPI densities.

CIRCLE 97 ON READER CARD

source data

Computer Design Development: Principal Papers
Earl E. Swartzlander, Jr., ed.
Hayden Book Co., Inc. 1976
320 pp. \$13.95

This collection of historical papers will be of interest to designers and users of digital computers and computer systems. The material is arranged in a progression from basic design concepts to small subsystems and complete computing systems—and in the areas of logic design, arithmetic algorithms and computer architecture. The papers focus on such topics as switching circuit design, high speed arithmetic, design of high speed multipliers, microprogramming, and the design and use of virtual memory. With the exception of Claude E. Shannon's master's thesis abstract, reprinted from 1938, and a paper by W. H. Eccles and F. W. Jordan which appeared in 1919, all the material is from 1951 through 1971.

Systems Engineering Methodology for Interdisciplinary Teams
by A. Wayne Wymore
Wiley & Sons, 1976
431 pp. \$27.50

When professionals from many disciplines form a team to design or analyze large scale, man/machine systems, many of the problems arise not from

mathematical, physical, or scientific considerations, but rather from the procedures or methods employed to perform the design or analysis. At least, this is the conclusion reached in this book, which is intended to train interdisciplinary teams in how to approach systems engineering for complex systems. Concepts illustrated include modeling and simulation, input/output analysis, technology, testing, and optimization; the only prerequisites are basic language skills and an interest in system theory and design. The methodologies are drawn from experiences in many industries, and the author has included numerous examples.

Structured Programming in APL
by Dennis P. Geller and Daniel P. Freedman
Winthrop Publ., Inc., 17 Dunster St.,
Cambridge, Mass. 02138 (1976)
324 pp. \$8.95 (paperback)

Designed for classroom or self-study, this introduction to programming and APL focuses on methods that enable the "student," experienced or not, to begin writing programs very early in the game. A useful feature sprinkled at various points in the book are "Interludes" which discuss important mechanical details such as signing on, creating and saving workspaces, and debugging aids. The foreword is by Gerald Weinberg, who is also the editor of this publisher's "Computer Systems Series."

Abend Debugging for COBOL Programmers
by B. H. Boar
Wiley & Sons, 1976
321 pp. \$17.50

One of programming's necessary evils is treated in a comprehensive manner in this study of methodologies and techniques available to debug abend (abnormal ending) core dumps. The book uses ANSI COBOL language under 360/370 OS/MVT operating systems as a case study to provide systematic approaches to the most familiar abend dumps. Abundant illustrations will enable the programmer to use the text effectively.

Technological Diffusion and the Computer Revolution: The UK Experience
by Paul Stoneman
Cambridge University Press, 32 E.
57th St., New York, N.Y. 10022
(1976)
219 pp. \$19.95

This is a study by an economist on the spread of computer usage in the U.K. and its implications to that country's economy. It is a rather technical study, modified from a Ph.D. thesis, which uses econometric techniques in its analysis. One finding is that, contrary to expectations, computers may have marginally increased the demand for labor through the late '60s, but the final effect will still be to reduce that demand. Also investigated is the modeling of an economy undergoing changes attributable to the growth in the use of computers.

CFI Data Module

The most technically advanced product in the line. First to incorporate heads and carriage into the module. Available in three models. Model 35—35 million bytes; Model 70—70 million bytes; Model 70F—70 million bytes with fixed heads for rapid paging. CIRCLE 98 ON READER CARD

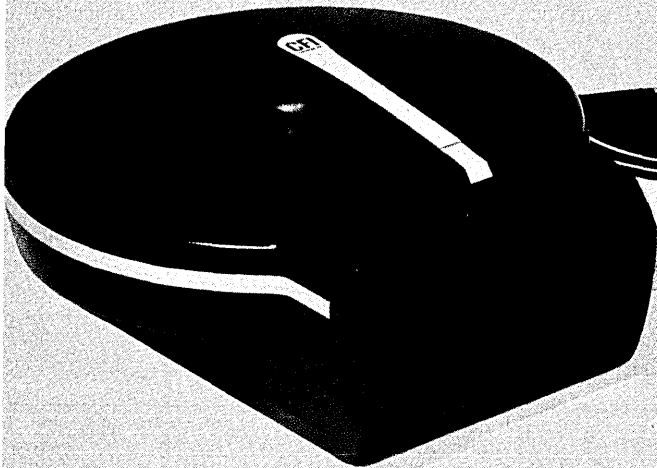

CFI Abraxas V Digital Cassettes

A complete line of cassettes in various grades. Designed for use with most digital recording and word processing equipment. CIRCLE 275 ON READER CARD

CFI Abraxas Diskettes

The first of our flexible-media line. We offer them both one-sided and two-sided and with various hard sector configurations.

The entire recording surface of every diskette is certified 100% error-free. Compatible with IBM 3740 and other diskette drives. CIRCLE 99 ON READER CARD



CFI Abraxas Computer Tape

A top-of-the-line tape line. Available in most lengths and configurations and various reel sizes. Tested for use at 1600 BPI and 6250 BPI. CIRCLE 276 ON READER CARD

Studies in Operating Systems
by R.M. McKeag and R. Wilson
Academic Press, 24-28 Oval Rd.,
London, NW1 7DX (1976)
263 pp. \$21.50

A variety of techniques were used to perform the same functions in each of four very different operating systems. A detailed comparison of these systems forms the basis for these studies. The systems compared are the Burroughs B5500 Master Control Program, the Cambridge University Titan Supervisor, the CDC 6000 Series Scope, and E. W. Dijkstra's T.H.E. Multiprogramming System. The presentation seems detailed and complete, and helpful glossaries are included.

reports & references

Computerized Data Files

Computer programs and data files generated by the federal government are listed and abstracted in the 456-page *Directory of Computerized Data Files, Software & Related Technical Reports*, 1976 edition. More than 1,100 programs and data files are fully described, up 500 from the last edition

(1974). Related documentation and technical reports, as well as price and where and how to obtain the product, are given. Three indexes—by subject, government agency, and number—are provided. Robert C. Goldstein's article, "The Costs of Privacy," reprinted from *Datamation* (Oct. '75), is also included. Order NTIS/SR-75/02. Price: \$50, book or microfiche (\$60, foreign). NATIONAL TECHNICAL INFORMATION SERVICE, U.S. Dept. of Commerce, 5285 Port Royal Rd., Springfield, Va. 22161.

Japanese Electronics Industry

By 1980, production levels in the Japanese electronics industry will grow 302% over 1973 figures; by 1985, the growth will be 586% more than 1973. So finds a 376-page report, *Future of the Japanese Electronics Industry*, which covers not only the future, but the past and present as well. The study includes commentary and statistics on consumer and industrial electronic product categories, as well as on semiconductor components. It examines the structure of the electronic industries, with special care to the computer industry, telecommunications, control technology, and consumer electronics, as well as import and export activities.

Researched in 1974 and printed in late 1975, this study gathers a large

amount of comprehensive information on the subject into one place. Of particular interest are forecasts based on the Delphi technique, and used for a large number of specific products. An appendix includes a chronology of the Japanese electronics industry and lists of electronic products by major companies. Price: \$210. FUJI DATA SERVICE, Akishoku Bldg., 3-8, Tomigaya 1-chome, Shibuyaku, Tokyo, Japan.

Software Directory

The July *ICP Software Directory*, "the world's largest directory of proprietary software," contains descriptions of over 3,600 software products from more than 900 sources. In two soft-cover volumes, *Data Processing Management* (systems and utility packages) and *Business Management* (application packages), the directory is comprised of vendor-written descriptions of the packages, including hardware requirements, price, and whom to contact. More than 150 categories are listed, and there is a useful cross index between package and hardware. About 2,000 products have been updated, and a new index for System/3 users has been added. Published semiannually, a yearly subscription is \$100; single copy, \$60. INTERNATIONAL COMPUTER PRODUCTS, INC., 1119 Keystone Way, Carmel, Indiana 46032.

CFI Abraxas III Disk Cartridge Cleaner-Verifier

To help maintain our line. Completely portable and self-contained unit cleans and mechanically tests both front and top loading cartridges. Prevents costly head crashes and reduces or eliminates soft errors caused by damaged or dirty disk cartridges.

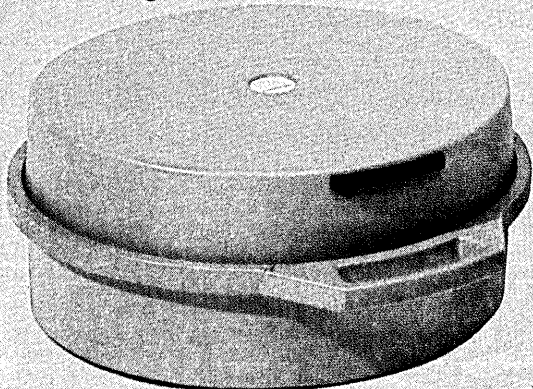

CIRCLE 277 ON READER CARD

CFI Abraxas IV Magnetic Tape Cleaner

Keeps our tape line clean. Safe and effective. Removes contamination which can seriously affect the operational capabilities of magnetic tape. CIRCLE 278 ON READER CARD



source data

European Electronics Suppliers Guide

Names and addresses of suppliers of electronics equipment in Europe are listed by particular industry (banking, textiles) or application (military, medical). The publication is trilingual (English, German, and French), and contains an alphabetical product index, a directory of companies by country with additional information (including telephone numbers), names and addresses of trade associations, and American companies in Europe. Price: \$48. Obtainable in the U.S. from Dept. BJ, ELECTRONIC NEWS, 7 East 12 St., New York, N.Y. 10003.

Insurance Computer Systems

The market for insurance-oriented computer systems and software programs will experience a growth of 100% over the next two years—and this growth will be further multiplied by ten over the next ten years. A major survey of insurance companies reveals trends and forms the basis of forecasts assembled in the 149-page report, *Data Processing Systems & Services in the Insurance Industry*. Projections through 1985 of the nature, size, and numbers of units and dollar volumes

for three types of computer systems, six types of data entry systems, and seven types of services and software are supplied. Price: \$600. FROST & SULLIVAN, INC., 106 Fulton St., New York, N.Y. 10038.

Data Base Planning

A 15-page information portfolio, "Establishing a Framework for Data Base Planning," identifies functional components of a data base system and analyzes the administration, operation, and implementation considerations of the planning process. Recommenda-

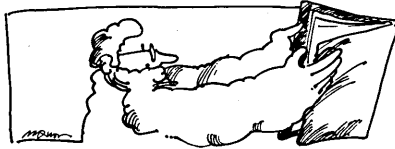

tions on planning, funding, and getting corporate approval are included. The portfolio is part of the information service, *Auerbach Data Base Management*. AUERBACH PUBLISHERS INC., Pennsauken, N.J.

FOR COPY CIRCLE 202 ON READER CARD

Business Automation Reference Service

A monthly updating reference service provides four two-volume looseleafs containing over 3,200 pages of descriptive information and specifications

on computer equipment, peripheral equipment, computer software, and office equipment. More than 45 categories are covered, including mini-computers, small business computers, terminals, word processors, copiers, microfilm equipment, etc. Products are described and compared to all models offered by a vendor within a particular product category, and the descriptions are user-oriented and easily understood. Included is also a monthly newsletter with commentary, industry developments, and capsule product descriptions. Subscriptions for each of the four categories: \$100; for all four: \$360; for the newsletter alone: \$30. ALLTECH PUBLISHING CO., Pennsauken, N.J.

FOR DATA CIRCLE 201 ON READER CARD

Tax Laws

A 156-page survey of sales, property, and use tax laws as they affect the computer industry has been prepared by ADAPSO's tax consultant, Prof. Richard D. Gould of the New England School of Law, with help from ADAPSO summer law fellows. Hardware is considered tangible personal property in all jurisdictions, and thus subject to property tax. California is one of several states that consider operations or system software part of hardware, and therefore taxable; but other states have yet to consider the question. Further

We take your business personally

We have made a major commitment to R&D and to the continuous refinement of the manufacturing process. We will continue to develop technologically advanced products for both the end-user and OEM.

We have also made a major commitment to a nationwide network of independent representatives. The men who sell and service our line have proven themselves to be the best in their field. That's why they represent CFI. They work hard to earn your business by giving you the kind of personal attention and professional service you just can't get any place else.

A nearby CFI representative is waiting to show you how you can get all the care and quality we put into our products and all the personal attention you could ever want at prices your accountant will appreciate. And that's really the bottom line.

Call us toll-free for the name of your local representative, 800/854-3290. Or write: CFI Memories, Inc., 305 Crescent Way, Anaheim, CA 92801.

CFI memories, inc.



source data

details on tax laws in all 50 states as they impinge on the dp industry are included, and ADAPSO plans to update the survey every six months. Price: \$90, plus \$2.50 postage and handling. ASSN. OF DATA PROCESSING SERVICE ORGANIZATIONS, INC., 210 Summit Ave., Montvale, N.J. 07645.

Privacy Legislation

A 20-page report, *Privacy Legislation—Trends and Impact on Computerized Information*, discusses trends in federal and state privacy legislation and the impact on dp activities. Specific discussions of the Privacy Act of 1974, the Freedom of Information Act, H. R. 1984, and the Privacy Protection Study Commission are included, as well as sample state legislation from New York. Price: \$7.50. CACI INC., 75 Rockefeller Plaza, New York, N.Y. 10019.

Prepackaged Software

A loose-leaf directory of "thousands" of prepackaged programs and data bases from hundreds of time-sharing sources, which are accessible by data terminal via telephone, is available. Entitled *Remotely-accessible Conver-*

sational Programs & Data Bases, the directory covers broad areas such as accounting, finance, insurance, lease analysis, production control, statistical analysis, stocks and bonds, etc. Each title is described with information on vendor, special features, accessibility, and occasionally, cost data. Price, including three bimonthly updates: \$28. GREGORY RESEARCH ASSOCIATES, 1900 Greymont St., Philadelphia, Pa. 19116.

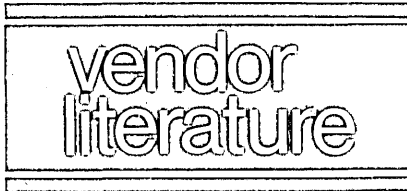

Data Communications

The Sensible Way to Use Computers in Data Communications, a 12-page illustrated brochure, describes this company's front end processing systems, message concentrator systems, message and packet switchers, and terminal systems. Specific users are shown in various data communications applications with the equipment described, and configuration diagrams illustrate different methods of network implementation. DATA GENERAL CORP., Southboro, Mass.

FOR COPY CIRCLE 255 ON READER CARD

Line Printer

A data sheet on this company's Model 2424 oem line printer, a medium speed, "high performance" printer with an optional "whisper quiet" configuration, is available. The printer is furnished with a 132-column print line and a 64-character ASCII font. A 96-character ASCII and a 64-character EBCDIC fonts are options available. Print speeds are 300 lpm for the 64-character version; 200 lpm for the 96-character; and 400 lpm for the 48-character version. DATA 100 CORP., Minnetonka, Minn.

FOR COPY CIRCLE 256 ON READER CARD

Composing & Editing

Described in its 4-page bulletin as "the first multi-processor composing and editing system," the VariComposer I's features—a minicomputer with floppy disc storage and 32K memory—are detailed. Four functions are performed simultaneously: input to disc; output from disc; hyphenation, justification, and editing; and hardcopy printout. VARISYSTEMS CORP., Plainview, N.Y.

FOR COPY CIRCLE 257 ON READER CARD

Business Systems

Five general accounting software applications packages which can be used individually or in combination are described in a multicolored brochure. The five, making up this vendor's

Your line.

800/854-3290

(In California 714/776-8571)

CFI memories, inc.

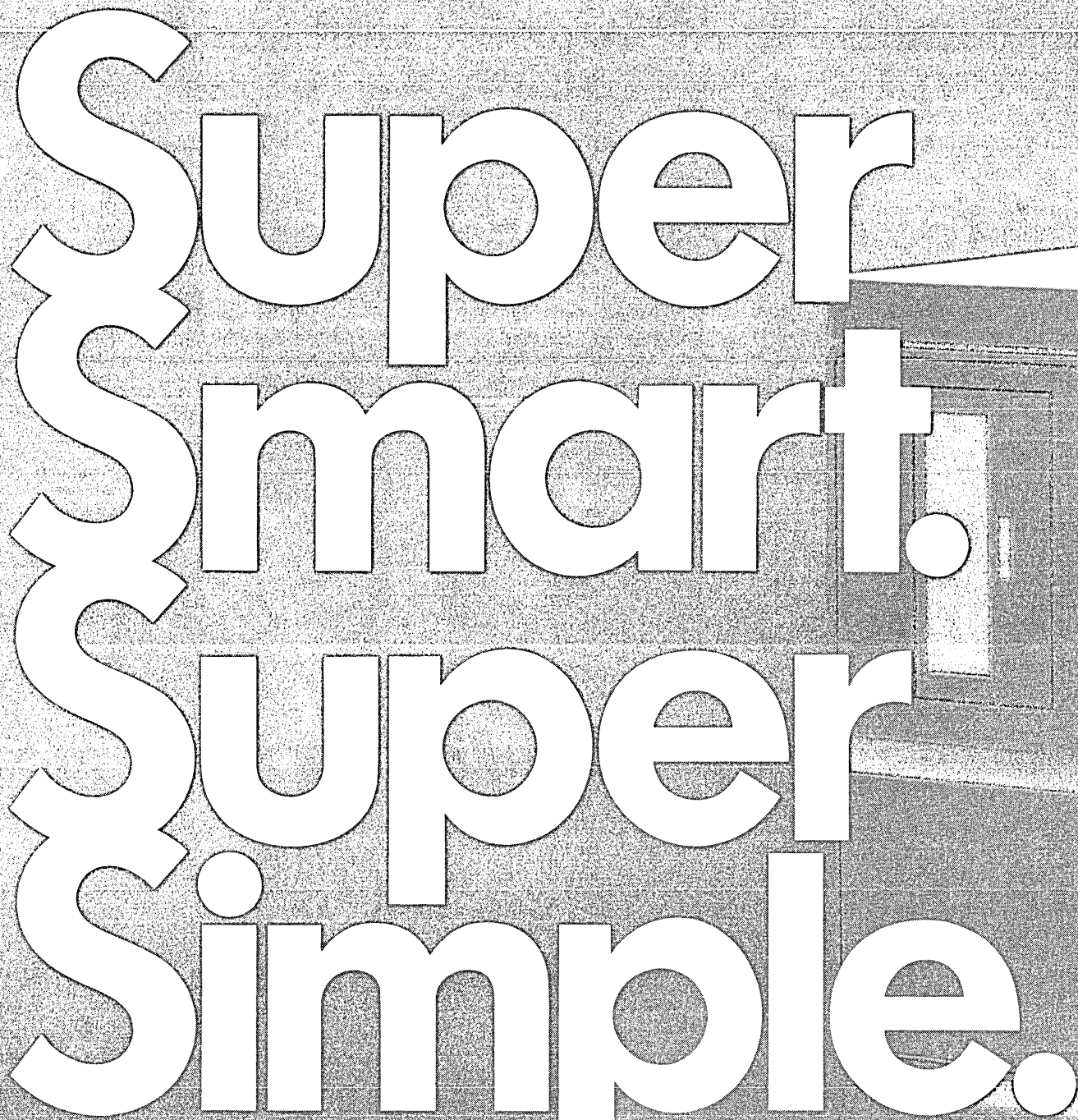

Super Smart. Super Simple.

Together for the first time in ADDS New System 70.

How smart is smart? The answer is simple.

ADDS new System 70 is a powerhouse that can SEARCH, VERIFY, COPY, SEND, RECEIVE, and PRINT the day you plug it in. It's all pre-programmed on dual microprocessors. That's smart.

And simple. Because to get System 70 to SEARCH, all an operator has to enter is the word SEARCH. We call it TCL; our Terminal Command Language. You'll call it EASY.

Smart is simple in more ways than one. Sometimes you want to take advantage of automatic data entry functions like arithmetic extensions, must-fill fields or check digit calculations. With System 70 you customize forms yourself, right on the display; without assembly or debugging of complicated programs. It's that simple.

And smart. System 70 is IBM 3780 or teletypewriter compatible. It has single or dual

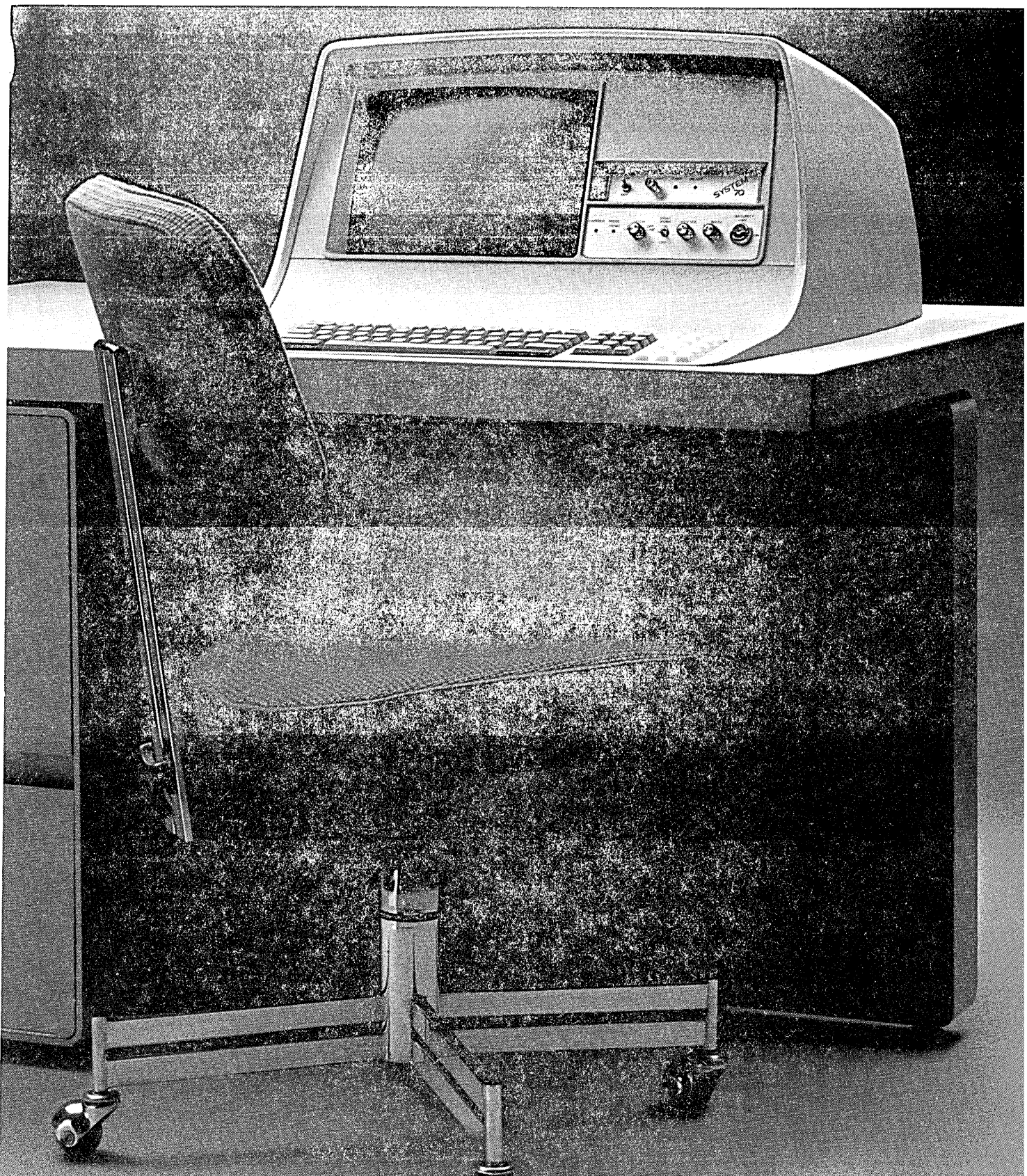

diskette drives which are IBM 3740 compatible. And our line of optional printers can put it all on paper at a reserved 30 characters-per second up to a snappy 300 lines-per-minute.

What does all this power cost? Practically peanuts. System 70 is under \$7,000 in moderate quantities. ADDS System 70.

Smart and Simple together mean more power to you.

ADDS Applied Digital Data Systems Inc.
100 Marcus Blvd.
Hauppauge, N.Y. 11787 (516) 231-5400

Please send more information about System 70:

Name _____
Firm _____ Title _____
Address _____
City _____ State _____
Phone _____

source data

"Comprehensive Business Systems," include complete order processing, accounts receivable; purchase order entry, general ledger, and payroll. These field-tested ready to use packages can be installed on all this vendor's small business computers. BASIC/FOUR CORP., Irvine, Calif.

FOR COPY CIRCLE 203 ON READER CARD

Microprocessors

This vendor's "total microprocessor capability" is described in an 8-page illustrated brochure. A chart relating

key system performance needs to TI microprocessor products is featured. Design support, features, operation and other technical information on the various series of products are included. Software, cpu's, support hardware, and memory components are described, and additional support offerings such as software assemblers, compilers, simulators, debug units, and hands-on tutorial classes are mentioned. TEXAS INSTRUMENTS INC., Dallas, Texas.

FOR COPY CIRCLE 209 ON READER CARD

Remote Plotting

An attractive multicolored 16-page brochure explains in nontechnical language remote computer plotting, its

history and development. The variety of uses and applications, as well as how (in simplified terms) remote plotters work, are discussed. The advantages and limitations of three types of plotters— analog, standard vector, and differential vector—along with their general descriptions, are given. There is also a useful mini-glossary of plotting terms included. ZETA RESEARCH, Lafayette, Calif.

FOR COPY CIRCLE 261 ON READER CARD

Image Processing

A series of applications notes is available which emphasize the variety and possibilities for use of this vendor's 8000 series digital image display system, capable of processing digital images at over 240 million bit per second transfer rates. Published bimonthly, these technical papers are written by Dr. Harry C. Andrews (of usc's Image Processing Inst.) and other experts in the field. Current titles include "Spatial Resolution: Requirements for Real-Time Digital Displays," "Pseudocolor," "Function Memory Application," and "Continuous Tone Images with Hidden Surface Removal." Upcoming topics include photographing the face of crts, and spatial warp.

This vendor's equipment, it is claimed, was used by Jet Propulsion Labs in the generation of color images from the Viking spacecraft on Mars. COMTAL CORP., Pasadena, Calif.

FOR COPY CIRCLE 262 ON READER CARD

Network Processor

A 12-page booklet, *A New Concept in Communications Network Optimization and Management*, written as a sort of mini-primer on communications networks for managers, also discusses this vendor's 6000 Series Intelligent Network Processor. Besides describing (with diagrams) the qualities, characteristics, and applications of the product, the booklet also discusses how the "6000 technology" can reduce the number of communications lines, increase traffic on existing lines, achieve error-free transmission between nodes, and support mixed protocols within a network. CODEX CORP., Newton, Mass.

FOR COPY CIRCLE 204 ON READER CARD

Buying/Selling Used Hardware

A 20-page booklet describes this company's multiple listing service for buyers and sellers of used computer equipment. The service is modeled on real estate procedures in that the seller lists his equipment with one broker, and the service distributes the listing to all brokers who are members of this service. Prospective buyers can look up all listings and pay no charge. But the booklet does not identify the brokers, nor give their number or commission

(Continued on page 44)

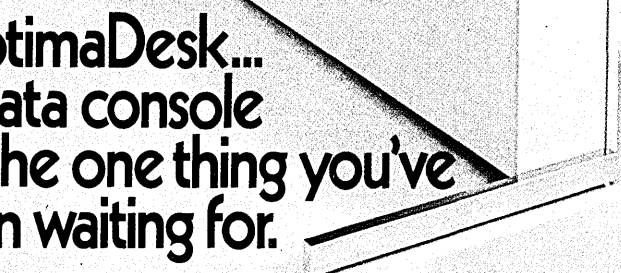

**OptimaDesk...
the data console
with the one thing you've
been waiting for.**

Everything.

Every feature you'll ever conceivably want, including the ones that cost extra in other data consoles (rolled front edge, chrome legs and the like.) Every color from Burnt Orange to Sky Blue to Black; eleven standard colors in all. Standard widths are 24", 45" and 66", each in a choice of keyboard or desk heights. And the two styles you see here are just the beginning.

Above all, the OptimaDesk is the finest quality furniture ever built for electronic instruments. And the price is right.

Write to us for complete information.

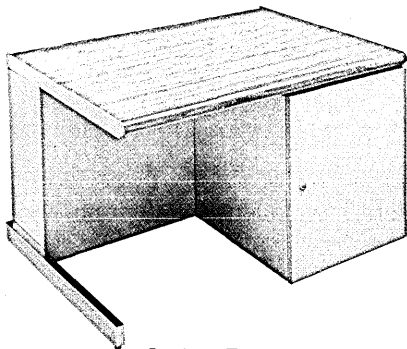

OPTIMA®

Optima Enclosures, a division of Scientific-Atlanta, Inc. 2166 Mountain Industrial Blvd., Tucker, Georgia 30084 or call (404) 939-6340

CIRCLE 143 ON READER CARD

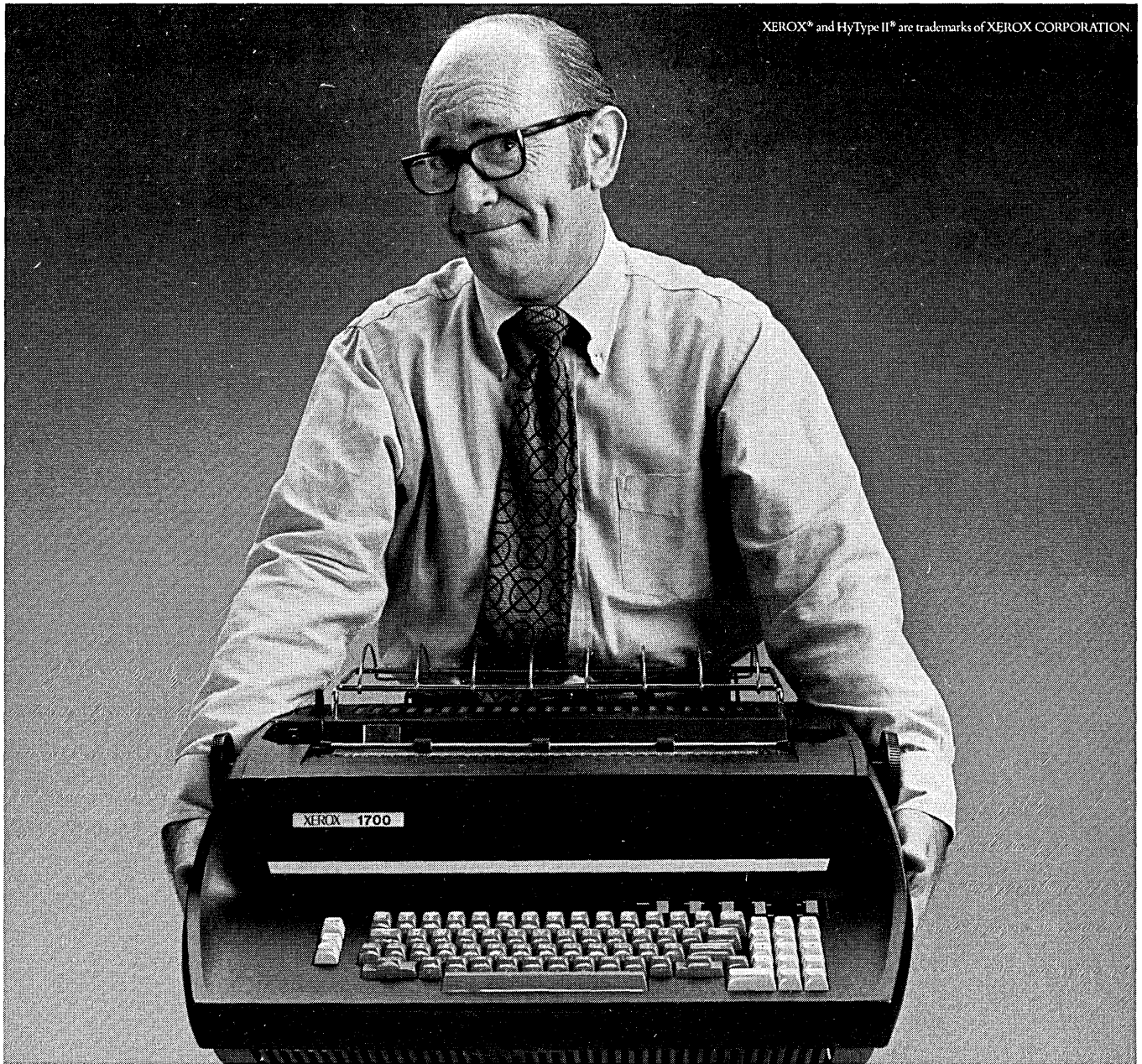

If you think this new Xerox terminal is right for you, you may be wrong.

It's not for everybody.

To appreciate the Xerox 1700 you have to do interactive work and also want very high print quality.

And you have to be intolerant of downtime.

The mechanism is our quiet, reliable HyType II. Sharp, crisp characters, even at 45 cps. (Normal on-line speed is 30 cps.)

Full ASCII character set. Prints forward and backward. Has 1/120" horizontal and 1/48" vertical resolution so you can print charts, curves, formulas, musical scores.

Sits on a desk. The microprocessor and other electronics are inside.

Supported and maintained by Xerox.

Expensive? Definitely not. Available on purchase, one-year lease, or 90-day trial lease.

Now, after all you've read, if you still think this terminal is right for you, you just might be right.

To make sure, call 213-679-4511—Ext. 2231.

Or write Xerox, Dept. A1-15, 701 Aviation Blvd., El Segundo, CA 90245.

Xerox Computer Printing.

XEROX

The inventors of magnetic tape just made a better "Winchester."



Back in 1932, BASF invented magnetic tape . . . the forerunner of such modern data processing media as the 3348 "Winchester" Data Module. Now BASF research has made significant improvements on the Winchester. While still completely compatible with existing 3340 drives, our new Data Modules feature an exclusive oriented oxide coating and polishing technique which offers 30-35% better resolution properties than competitive Winchester-type packs.

Our new finish allows the read/write heads to fly uniformly and four times smoother than independent competitive module heads . . . resulting in greatly reduced possibilities of error generation. In addition, BASF has developed a special disk-surface lubricant, which eliminates disk coating wear and consequent contamination and errors. This lubricant also eliminates, for the first time, any

possibility of a head sticking to the disk surface while the module is stored.

BASF Data Modules are available in three configurations: the 1335 Module, with 35 million-byte capacity; the 1370, with 70 million-byte capacity; and the 1375, with fixed head and quicker access. Because our error testing is twice as critical as drive manufacturer's specifications, we warranty our Data Module to be free from manufacturing defects for as long as you use it.

For complete details on the BASF "Winchester" Data Module, write: BASF Systems, Crosby Drive, Bedford, MA 01730, or call our nearest regional office: in Los Angeles, (213) 451-8781; in Dallas, (214) 233-6607; in Chicago, (312) 343-6618; in Clifton, NJ, (201) 546-9111; in Montreal, (514) 341-5411; and in Toronto, (416) 677-1280.

CIRCLE 12 ON READER CARD

BASF The Original.

Computer Tapes Disk Packs Flexydisks Word Processing Supplies

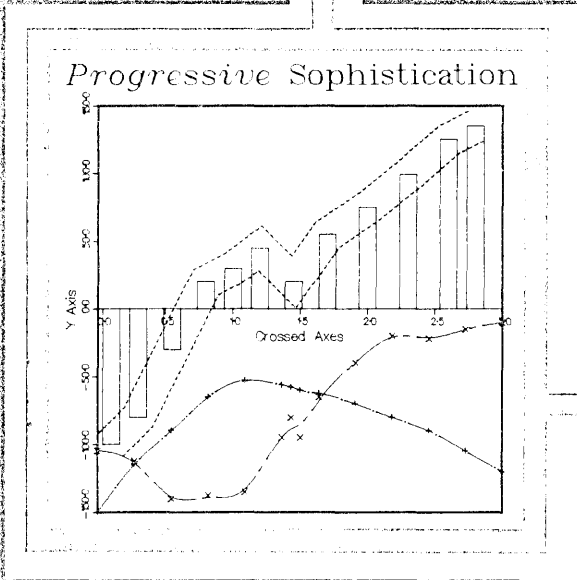
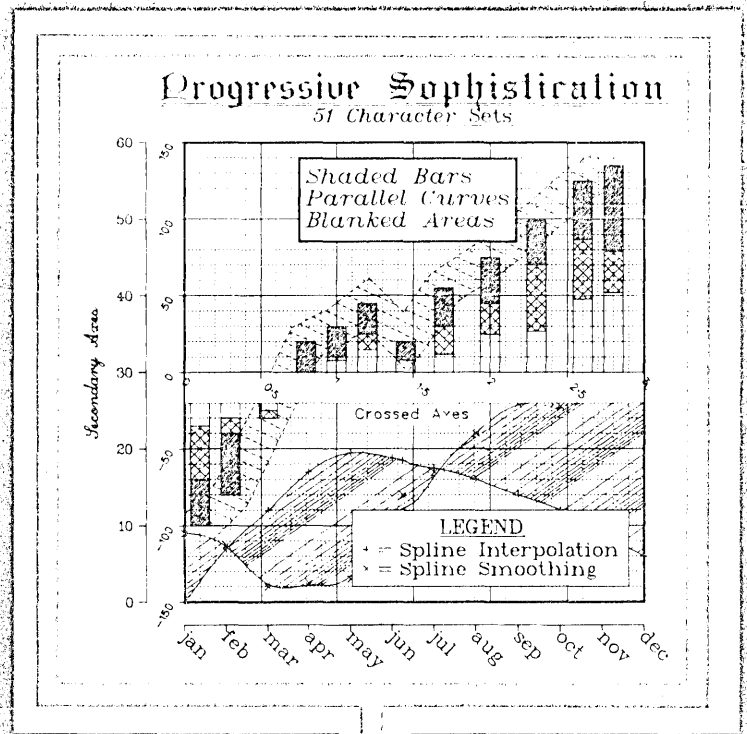
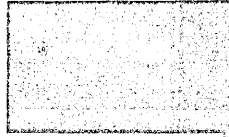
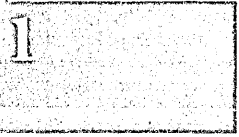
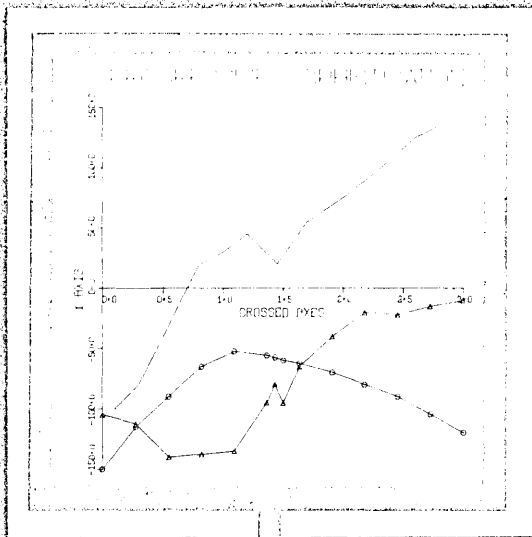

2

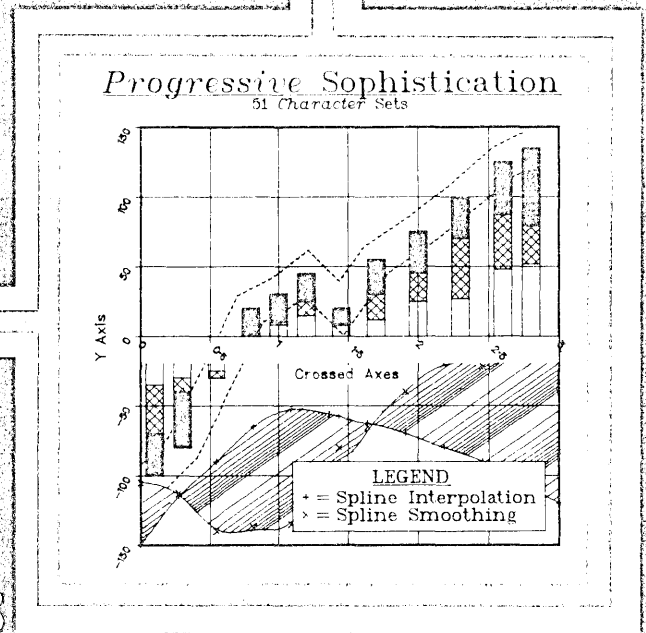

3

DISPLA makes complex plotting simple.

Some of the best known computer centers in the world are our users. Many of them already had powerful graphics. So why choose DISPLA? Simple. It's **machine and device independent**. It offers unmatched features from publication quality fonts to 3-D hidden line surfaces and world maps. But, above all, it's easy to use.

Start with a simple plot of 3 curves. Scaling, centering and rounding are automatic unless specified otherwise.

Add a few "calls" to (1) for italics, bars, parallel curves, dashed lines and smoothed connection. The calls of (1) are essentially unchanged.

To (2) now add a grid, shading, legend, blanked areas and angled axis numbering. We **add to, not modify** previous instructions.

The plot becomes complex simply—with a dotted grid, more axes, month labeling, text and even Gothic lettering!

Draftsman quality plots are generated by the thousands every day on over fifty installations internationally. Ask our customers.

DISPLA

Display Integrated Software System and Plotting Language
A proprietary software product of ISSCO

For more information call Sunny Harris (714) 452-0170 or (714) 565-8098.

Or write

ISSCO

Integrated Software Systems Corporation

4186 Sorrento Valley Blvd., Suite N, San Diego, CA 92121

In Europe contact: Repko bv, Van Blankenburgstraat 58
The Hague, Holland
Telephone 070-608425

Try pricing out the cost of lost data.

Then you'll know why over half the certified digital cassettes in use throughout the world today are made by Information Terminals.

A dropped bit could mean only a misspelled name. It could also mean a check a hundred or a thousand times too big, a carload shipment sent to the wrong destination, or a fleeting moment in time lost forever!



100% Certified. You can be sure with ITC.

To help protect you, your company and your projects against such losses, ITC tests its computer grade information storage media 100% after assembly.

This means every ITC computer grade digital cassette, floppy disk, FLIPPY™ disk, 1/4-inch Data Cartridge and Mini-Cassette is checked for perfect mechanical and recording operation before it leaves our hands. 100% Certified. You're sure with ITC.

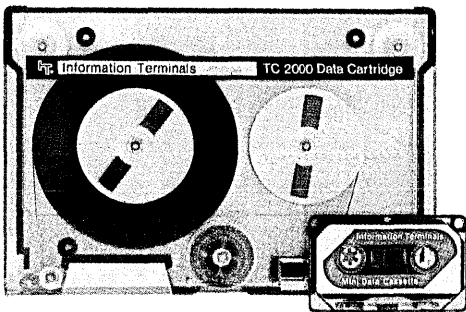

A medium for every message.

ITC 100% CERTIFIED DIGITAL CASSETTES. Five Series, to fit just about every system and environmental requirement, from computer room or business office to desert, jungle or frigid mountain top.

ITC 100% CERTIFIED FLOPPY AND FLIPPY™ DISKS. One-sided floppies and two-sided FLIPPIES™.

No matter what or who's diskettes you've been using, there's a 100% Certified ITC disk you can depend on.

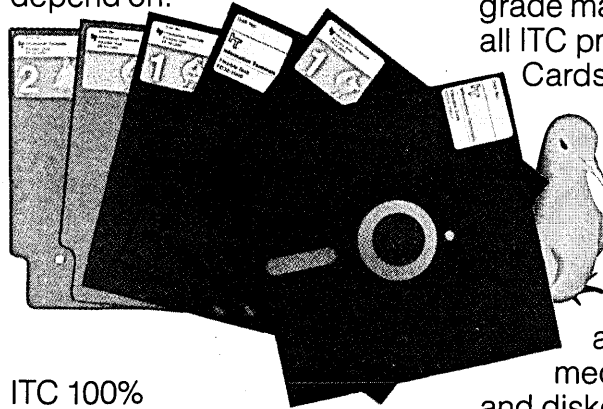

ITC 100% CERTIFIED 1/4-INCH DATA CARTRIDGES. ITC's new 1/4" Data Cartridges, with exclusive new features for new levels of performance and reliability.

ITC 100% CERTIFIED MINI-CASSETTES. A unique new approach to data storage in hand-held and desktop digital devices. ITC's MI-50 Mini-Cassette

packs 50 feet of data capture in a package smaller than a box of pocket matches.

ITC MAGNETIC CARDS FOR WORD PROCESSING SYSTEMS.

High quality products for the Office,



from the leading producer of 100% Certified computer grade magnetic media. Like all ITC products, our Mag Cards feature consistently high performance from one shipment to the next.

Write for Information on ITC computer grade and word processing media, and our cassette and diskette testing and alignment equipment. Or call your nearest ITC distributor or representative.

Information Terminals
323 Soquel Way
Sunnyvale, California 94086
Telephone (408) 245-4400

In Europe:
Information Terminals SA
Case Postale 296
1215 Geneva
Switzerland

How to evaluate the efficiency of a DBMS

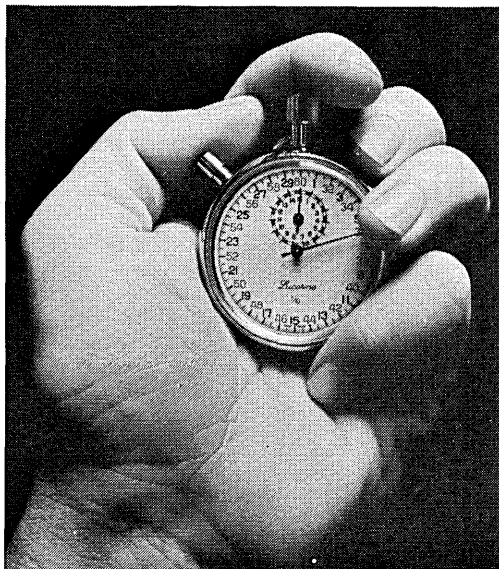

There are two factors to consider when evaluating a DBMS: human efficiency and computer efficiency.

In terms of human efficiency, RAMIS users have found that 75 percent of their information processing can be performed by the RAMIS nonprocedural language in one-fifth the time required by conventional programming languages.

For example, in the time it takes to write one typical Cobol program, 10 to 20 RAMIS procedures can be written. In some cases a whole system can be written in one day.

"What-if" questions can be answered even faster. In the time it would take Cobol, Fortran or any procedural language to answer one query, RAMIS can answer almost 40.

So when management wants an answer fast, you can provide it in minutes or hours instead of two or three days.

That's fast.

In terms of computer efficiency, RAMIS procedures use no more computer resources than the average Cobol program doing the same work.

In terms of storage efficiency, a RAMIS data base normally requires less storage space than the same data stored as sequential files.

In addition, RAMIS provides the DP department with tools for analyzing the impact

of RAMIS applications on computer resources and for scheduling file reorganization. RAMIS is constantly being enhanced by our engineering staff to provide users with on-going improvements in both

human and computer efficiencies.

To find out how RAMIS efficiency can help you, use the coupon below or contact Mark Berkowitz, Vice-President, U.S. Operations at (609) 799-2600.

ramis[®]

Mathematica Products Group
P.O. Box 2392, Princeton, N.J. 08540

Please send me information on RAMIS

Name _____

Title _____

Company _____

Address _____

City _____ State _____ Zip _____

Phone _____

DMS

source data

(Continued from page 38)

rates. However, the service seems like a convenient way to bring together buyers with sellers. **COMPUTER MULTIPLE LISTING SERVICE**, Fairfax, Va.
FOR COPY CIRCLE 258 ON READER CARD

Telex and Cables

Telex and cablegram rates from the U.S. to over 150 countries, including area codes for those countries, are listed in the latest WUI rate booklet. Since Telex rates are by the minute and cablegram rates are by the word, there is a "breakeven point" when the words reach a certain number; "breakeven points" are listed. Step by step procedures for sending messages on international, domestic, and TWX machines are also given. **WESTERN UNION INTERNATIONAL**, New York, N.Y.
FOR COPY CIRCLE 205 ON READER CARD

Plotting Software

Sample plots produced on this vendor's Status printer/plotter form the core of 12-page brochure on the company's Dataplot III software. Three levels of software are explained: driver, plotter,

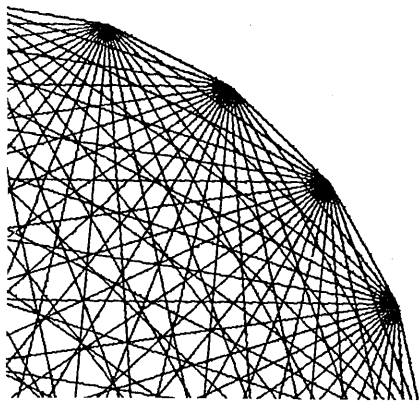

and application. Various routines and features of the software, such as plotting any of 12 special designs or in 16 shades of gray, as well as a variety of figures, are illustrated. **VARIAN GRAPHICS DIV.**, Palo Alto, Calif.

FOR COPY CIRCLE 206 ON READER CARD

OCR Applications

A 24-page illustrated booklet, *OCR Applications Sketchbook*, discusses optical page readers, one type of OCR machine, with emphasis on those developed specifically for dedicated mini-computer systems. Written for laymen, the booklet also gives the reader a general discussion of OCR capabilities, applications (word processing, data entry, telecommunications, graphic arts), advantages, and future possibilities. Two examples (in text processing and

communications) are featured in greater depth. **CONTEXT CORP.**, Burlington, Mass.

FOR COPY CIRCLE 207 ON READER CARD

Clustering Terminals

Product literature describes this vendor's CLU-8 Terminal Clustering Unit which increases the number of terminals served by a single modem in multiple terminal data communications networks. Diagrams illustrating sample system applications are included, and among the characteristics claimed are fully automatic operation, no adjustment or maintenance requirements, failsafe circuitry, and extension of modem servicing range. **SYNTECH CORP.**, Rockville, Md.

FOR COPY CIRCLE 208 ON READER CARD



Security/Privacy

Three-day workshops on computer security and privacy are scheduled for Phoenix on Sept. 28-30, Oct. 19-21, Nov. 16-18, and Dec. 7-9. Case studies and team analyses of actual cases will be examined. Emphases will include risk analysis, operations security, internal computer security, physical data center security, computer auditing, system monitoring and surveillance, and disaster recovery planning. Price: \$350. **HONEYWELL INFORMATION SYSTEMS**, P. O. Box 6000, Phoenix, Ariz. 85005.

Computer Applications

A short self-study course for non-dp managers, *Computer Applications*, consists of nine booklets, each a complete study unit with self-scored review exams. Objectives, case studies, problem-solving exercises, summaries, check lists, planning drills, and other items comprise each booklet. Titles of some of the booklets are "The Nature of Management Information Systems," "Automated Decision Making," "Data Processing Tools," "Current and Future Developments," and "Planning and Staffing for Total Systems." Roger L. Sisson and Richard G. Canning are the authors. Price: \$29.95. Professional Development Programs, **JOHN WILEY & SONS, INC.**, 605 Third Ave., New York, N.Y. 10016.

User Oriented Systems

Developing User Oriented Systems is a two hour audio cassette course with accompanying workbook, visuals, reference material, and flowchart tem-

plate. The purpose of the course is to teach system design and system development techniques, with special emphasis on defining the primary system requirements before programming begins. A course prospectus and wall chart defining goals, objectives, and tasks for such systems are offered free. Dennis A. Fletcher is the author. Price: \$125. **INFO 3**, Studio City, Calif.
FOR COPY CIRCLE 259 ON READER CARD



Key Abstracts

The IEEE and INSPEC (Information Services Div. of the Inst. of Electrical Engineers) recently initiated a series of monthly abstracts of current literature in several fields. Each *Key Abstract* is for a separate field, and among the fields are communications technology, systems theory, solid state devices, electronic circuits, industrial power and control systems, and power transmission and distribution. Each issue is 24 pages and contains about 250 items culled yearly from an average of over 2,000, worldwide publications, over 500 conference proceedings, 2,000 reports, 100 university theses, and more than 300 books. Subscription: \$35 (\$19.50 for IEEE members). **THE INSTITUTE OF ELECTRICAL AND ELECTRONICS ENGINEERS, INC.**, 445 Hoes Lane, Piscataway, N.J. 08854, or **INSPEC Marketing Dept.**, IEEE, P. O. Box 26, Hitchin, Hertfordshire, SG5 1RS, England.

ComputerData

ComputerData, a monthly Canadian magazine, is expanding its circulation from members of the Canadian Information Processing Society (CIPS) to an industry wide base. Feature articles as well as columns by government watchers in Ottawa and Washington, a West Coast commentary, a computers and the law column written by American lawyer Robert Bigelow, a "consumer view," and other items make up the monthly mix. In-depth profiles of prominent persons in the field, and special reports—the first issue (May) covered the installation of Canada's first Amdahl system at the Univ. of Alberta, the second presented word processing and computerized typesetting at major Canadian newspapers—can also be found each month. Roy J. Whitised is the editor/publisher. Yearly subscription: \$15. **WHITISED PUBLISHING LTD.**, Suite 2504, 2 Bloor St. W., Toronto, Ontario, M4W 3G1, Canada. *

HEWLETT-PACKARD

COMPUTER ADVANCES

Fast, flexible and efficient—the HP 2645 is a powerful addition to Hewlett-Packard's growing family of multipurpose display terminals. With extensive features, the HP 2645 was designed to adapt to a diversity of application requirements. The microprogrammed HP 2645 offers simplicity of operation through user defined Soft Keys that match the keyboard to the application.

HEWLETT-PACKARD ANNOUNCES THE 2645

Up to 12 kilobytes of display memory "stretch" the display to fit the application. Added Mini Cartridge mass storage for off-line operation decreases the application's dependence on the com-

puter. Flexibility in data communication, speeds up to 9600 bits per second and polling (async. and sync.) facilitate "hardware fitting" an application. Forms drawing capability, field checking, adjustable margins and full editing make the HP 2645 perfect for data handling applications. The HP 2645 is simple to use; yet adept with complex applications. 



**A DISPLAY STATION WITH CAPABILITIES
AS DIVERSE AS YOUR COMPANY'S REQUIREMENTS.**

THE HP 2645 DISPLAY STATION

A company wide information link to plant, warehouse, computer center, and sales offices.



Job management improves with HP 2645's daisy chained throughout the manufacturing plant.

Imagine a hypothetical manufacturing plant . . . To solve the problem of locating, expediting and reporting the status of production jobs in process, a number of HP 2645's are placed strategically around the factory. At a terminal, production workers simply enter jobs as they begin them and log them off when they are finished. For those unfamiliar with computers, the terminal's Soft Keys simplify data entry and reduce errors.

Soft Keys are a Hewlett-Packard innovation which shorten data input time and ease interaction with the computer. Each of the HP 2645's eight Soft Keys can be user defined to issue up to 80 characters or to execute several control sequences with only a single keystroke.

With the HP 2645's polling capability, as many as 32 terminals can be spread at distances of several thousand feet and can share a single line and computer I/O port. The results are minimum network costs, fewer wiring tangles and convenient job control.



Inventory control tightens with a remote HP 2645 and inventory transactions stored locally on internal mini cartridges.

At warehouses several miles from the main plant, tighter inventory control results from use of the HP 2645's powerful stand alone capabilities made possible by optional internal mass storage on two magnetic tape Mini Cartridges. Personnel enter transactions onto forms displayed on the 2645's screen. One cartridge stores the new inventory entries for periodic batch transmission to the computer. The second cartridge receives and stores both the forms and the updated inventory. Here, the HP 2645 reduces paperwork and its costs, minimizes charges for telephone lines and computer connect time, and also assures a duplicate inventory record separate from the central computer.

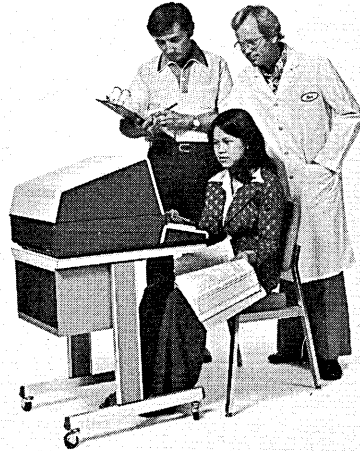

Programming is fast and simple with an on-line HP 2645 in the operations center.

Programmers find that the HP 2645's line drawing capability simplifies their preparation of display forms that look like those printed forms company people already are familiar with and accustomed to using. Soft Keys, when programmed to automatically enter multiple keystroke sequences, shorten the time necessary to input repetitive subroutines. Altering programs is a snap with the terminal's many editing features, such as insertion, deletion, writeover and adjustable margins for multiple columns.



Secretarial efficiency improves with a stand alone HP 2645 and printer.

Secretarial efficiency improves by using the HP 2645 with a printer in a stand alone combination to retype original form letters and to revise drafts of text. The HP 2645 displays upper or lower case letters, tabulates and backspaces. An executive secretary types management memoranda onto cartridges for later transmission to terminals throughout the company.



Communications costs and order entry errors decrease with HP 2645's in distant sales offices.

Field sales offices dramatically reduce line charges by using HP 2645's. Whereas before, each terminal needed its own leased line, daisy chained HP 2645's clustered in a single office share a common modem, and single communication line. With the choice of asynchronous or synchronous (Bisync) modes of operation, the sales office has chosen synchronous (Bisync) to gain the speed of 9600 baud remote transmission. Order errors diminish with the terminal's field

checking capability (fields are the blanks in displayed forms.) Alpha/numeric field checking, for instance, prevents entering numbers where letters go and vice versa. The high speed cursor, showing where the next entry will go, simply passes over a protected field (one containing the order heading, for example) and goes to the next open blank. Page scrolling for lengthy forms and full edit features help prepare, correct and change orders before transmission. 

THE HP 2645 DISPLAY STATION

The 2645 is a high resolution display station that operates at up to 9600 baud and offers async, point-to-point data communications. Optional capabilities include both async. and sync. (Bisync) polling for multi-point communications. Internal mass storage extends the 2645's capabilities. User defined Soft Keys allow the keyboard to adapt to specialized applications. Forms mode and full editing capability round out the data entry characteristics of the 2645.

For more information describing the HP 2645's extensive features, indicate A on the reply card. 

INNOVATIONS IN DATA COMMUNICATIONS

Detecting the Undetectable: New Insight Speeds Network Setup & Debugging.

The HP 2640, the first display terminal introduced by Hewlett-Packard, began a tradition. The pressing of a single key initiates a Self-Test and instantly verifies that the HP 2640 terminal is working properly. The newest of the family, the HP 2645 Display Station continues this Self-Test tradition and adds a new concept—Monitor/Driver Mode.

When a problem appears in a data communication network, the list of possible malfunctions is long. Perhaps the modem is faulty, or maybe there is transmission interference on the telephone lines. But then . . . it could be a problem with the computer itself. Or the fault could reside in any of a number of plugs, cables and connectors. The Self-Test feature helps clear the confusion and isolate the fault so that immediate corrective action can be taken.

The Self-Test feature is a firmware program that assures that the HP 2645 is working. It checks the HP 2645's power supply, ROM and RAM memory, microprocessor, data communications interface, etc., and displays the results in a complete test pattern. Self-Test can also capitalize on the analog and digital loop back capability of modems. The HP 2645 sends out 128 different characters which upon reaching a modem or special Self-Test

Plug are looped back to the terminal. A simple comparison indicates if a problem exists in the part of the network under test. Full documentation, including flow charts, assists a user to systematically "Self-Test" in tracking down problems.

To help further isolate problems in the communication network, the HP 2645 has an optional feature called Monitor/Driver Mode which is used in a polling environment. In Monitor Mode, a daisy chained terminal actually allows the user to view data being transmitted because the HP 2645 displays the data as it passes by. This "insight" helps analyze and determine which terminal sent data out of sequence, prematurely, or not at all. In addition, Driver Mode allows one terminal to generate typical polling and selection sequences for other terminals on the same communications line, a handy debugging tool for really tricky problems. Data transfer is a dynamic process and has been difficult, until now, to capture in a single transmission snapshot. Once flowing data can actually be seen on the display, problems are easier to see and simpler to resolve.

Monitor/Driver Mode plus Self-Test speed debugging a system and help get an on-line system quickly on the air. What was previously mystery is now detectable. 

ISOLATE HARDWARE PROBLEMS

Self-Test feature permits fast hardware fault isolation in a communication network. Faults can be easily isolated by looping back data from any of four logical points.

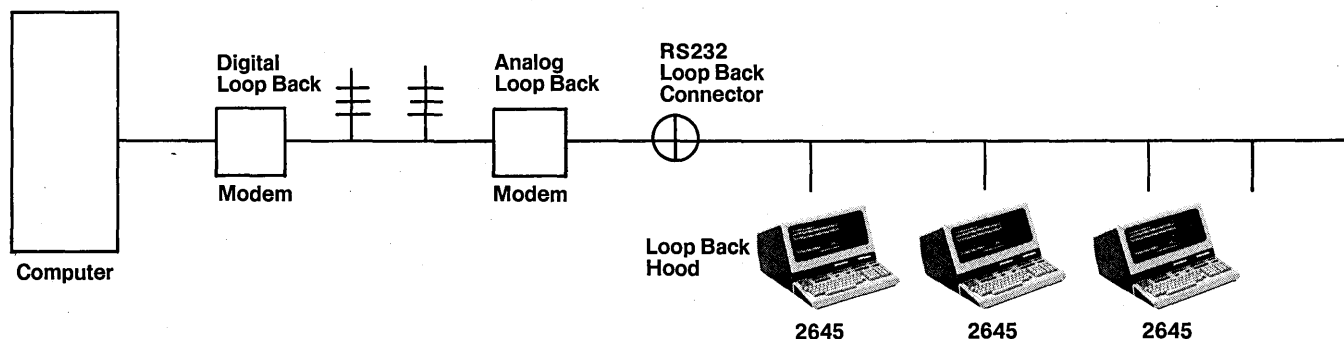

SEE LOGICAL PROBLEMS

With Monitor/Mode's "insight," dynamic data transfers from both the computer and terminal can be seen and analyzed.

For more information on the HP 2645 data communication's innovations indicate B on your reply card.

NEW: HEWLETT-PACKARD COMPONENTS

Help OEM's maximize value added opportunities.

In a major extension of its OEM line, HP is introducing two products in component form: the HP 2649 terminal and 21MX-K Series Minicomputer. Developed for the OEM designer who needs greater flexibility, both products consist of hardware subassemblies that can be ordered in the most cost-effective configuration for a particular application. Both permit functional customization through microprogramming.

Comprehensive documentation is available for both products so that technically oriented users can take full advantage of the products' flexibility. These products broaden HP's OEM product line to range from components, terminals and other peripherals through minicomputers, discomputers and the new HP 3000 Series II general purpose computer system.

Now: a way to get a custom terminal without paying a custom price.

With HP's new 2649 Mainframe Terminal, designers can create a variety of specialized terminals from multiple hardware building blocks—all controlled by custom, proprietary firmware without costs associated with developing a specialized terminal from scratch.

All information needed to develop source code for custom firmware is available in a technical support package. Object code can be assembled on an HP RTE Minicomputer system using a 13290 Development Terminal as the system console and a firmware support package.

With the 13290 Development Terminal, object code can be loaded from Mini Cartridges to 24K bytes of Writable Control Store (WCS) for verification of user-developed programs.

Once developed and debugged, custom firmware coding can be easily transferred to programmable-read-only-memory (PROM) chips for installation in multiple HP 2649 Mainframe Terminals. For high-volume applications, read-only-memory (ROM) chips are available from specified vendors.

Technical assistance in developing custom firmware is available directly from Hewlett-Packard. Among other services, HP will offer a series of in-depth "how to do it" seminars for customers wishing to get the most out of the new HP 2649 Mainframe Terminal.

Hardware options for the terminal include two keyboards, four character sets and fonts, six memory modules, four data communications modules and two I/O modules. A display enhancement module and two

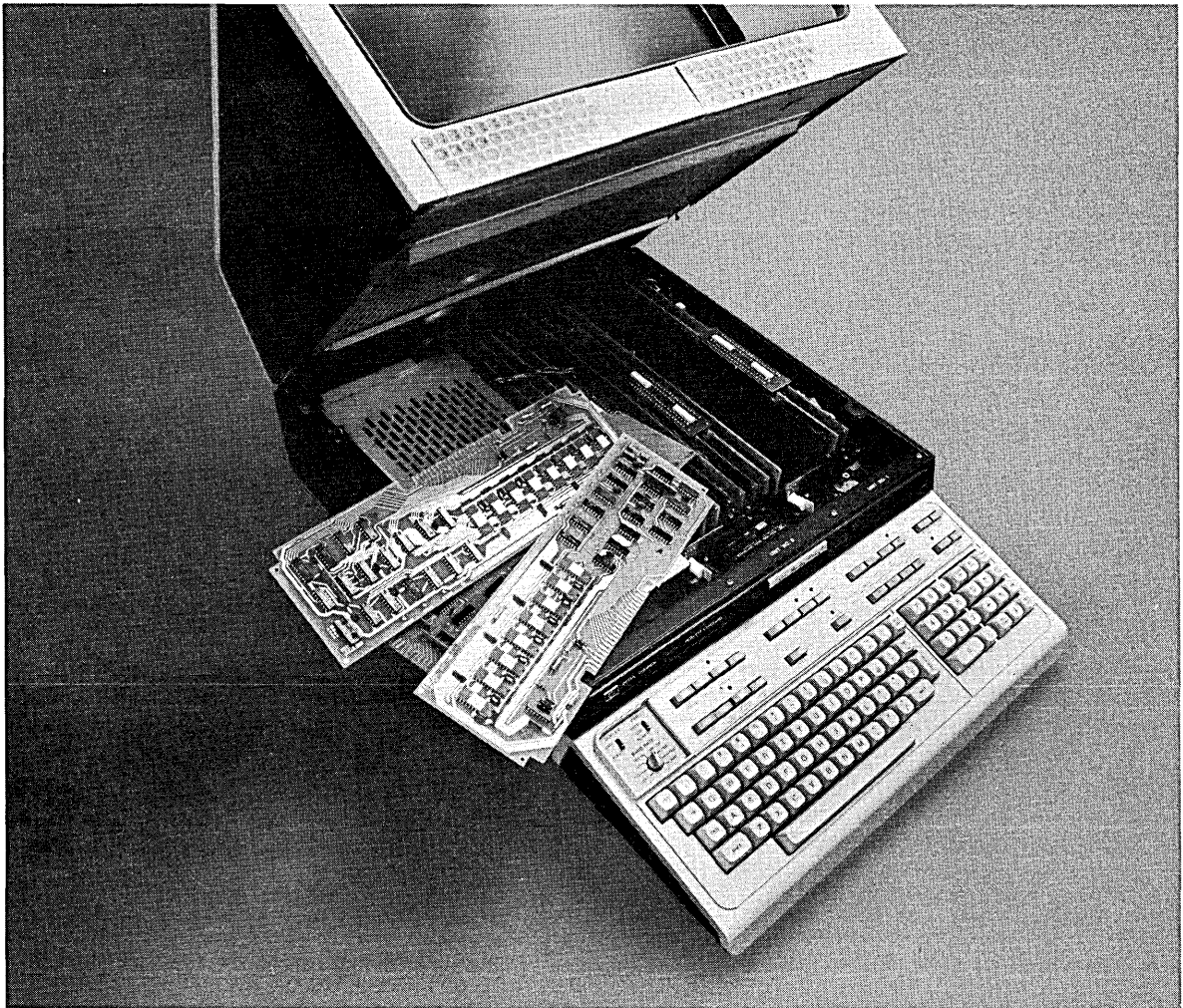

HP's new 2649 Mainframe Terminal offers an easy way to develop specialized display stations for specific system applications. Multiple hardware options are available and custom firmware can be used to redefine the Terminal's operating characteristics. Minimum contract quantity is 20 units; OEM and Volume End User discounts are available.

printer subsystems are also available.

For more information on the easy way to create specialized terminals for your next systems application, indicate C on the attached reply card.

Now: microprogrammable computer power in component form.

For the OEM designer who needs the power of a minicomputer and the flexibility of a microprocessor in his next system, HP has a new and intriguing product: 21MX K-Series Minicomputer Components.

Designed to fill the need for high-power processing in a low-cost form that integrates easily into OEM systems, K-Series Components offer unique flexibility through microprogramming. Systems engineers can now gain direct access to an extraordinarily fast processor which features a 325 nano-second cycle time and 210 powerful microinstructions. And, by adding a 21MX read-only-memory (ROM), get a full minicomputer that is hardware- and software-compatible with HP's entire line of 21MX memory systems, software, peripherals and accessories.

In any systems design, K-Series

Components provide:

- A high-performance "computer-on-a-board" that can run up to five times faster than MOS/LSI microprocessors and support large amounts of memory for complex tasks like array processing or pattern recognition.
- Access to a full set of microprogramming tools which let OEM designers develop custom firmware for high-speed execution of specialized routines.
- A choice of easy-to-install components that can be hidden in an OEM system and operated through a custom front panel.
- The opportunity to maximize added value while taking advantage of 21MX-compatible software.

Among the many systems applications which can use the speed and power of K-Series Components are spectrophotometers, numerical control units, smart data-entry terminals, word processing equipment, graphic display systems, medical diagnostic systems, and many kinds of test equipment.

K-Series Components include the processor board, 21MX Instruction

ROM, a front panel assembly and card cages with either eight or 18 slots for memory and I/O cards. Accessories include all 21MX memory systems, Writable Control and User Control Store boards for storage of microprograms, a Dynamic Mapping System which permits addressing of up to 256k words of memory, a Dual Channel Port Controller, a fast FORTRAN processor and a Memory Protect System.

A wide selection of I/O subsystems is also available for use with K-Series Components. These include the HP-IB* I/O Kit which simplifies configuration of automated test/measurement systems by allowing the computer to control multiple cluster of up to 14 compatible instruments each.

In short, HP's new K-Series Components offer unusual design flexibility at a very attractive price. U.S. prices for the processor board (OEM quantity 100) are \$975 without and \$1205 with the 21MX Instruction ROM.

For more information about HP's latest addition to the 21MX Minicomputer family, indicate D on the attached reply card. 

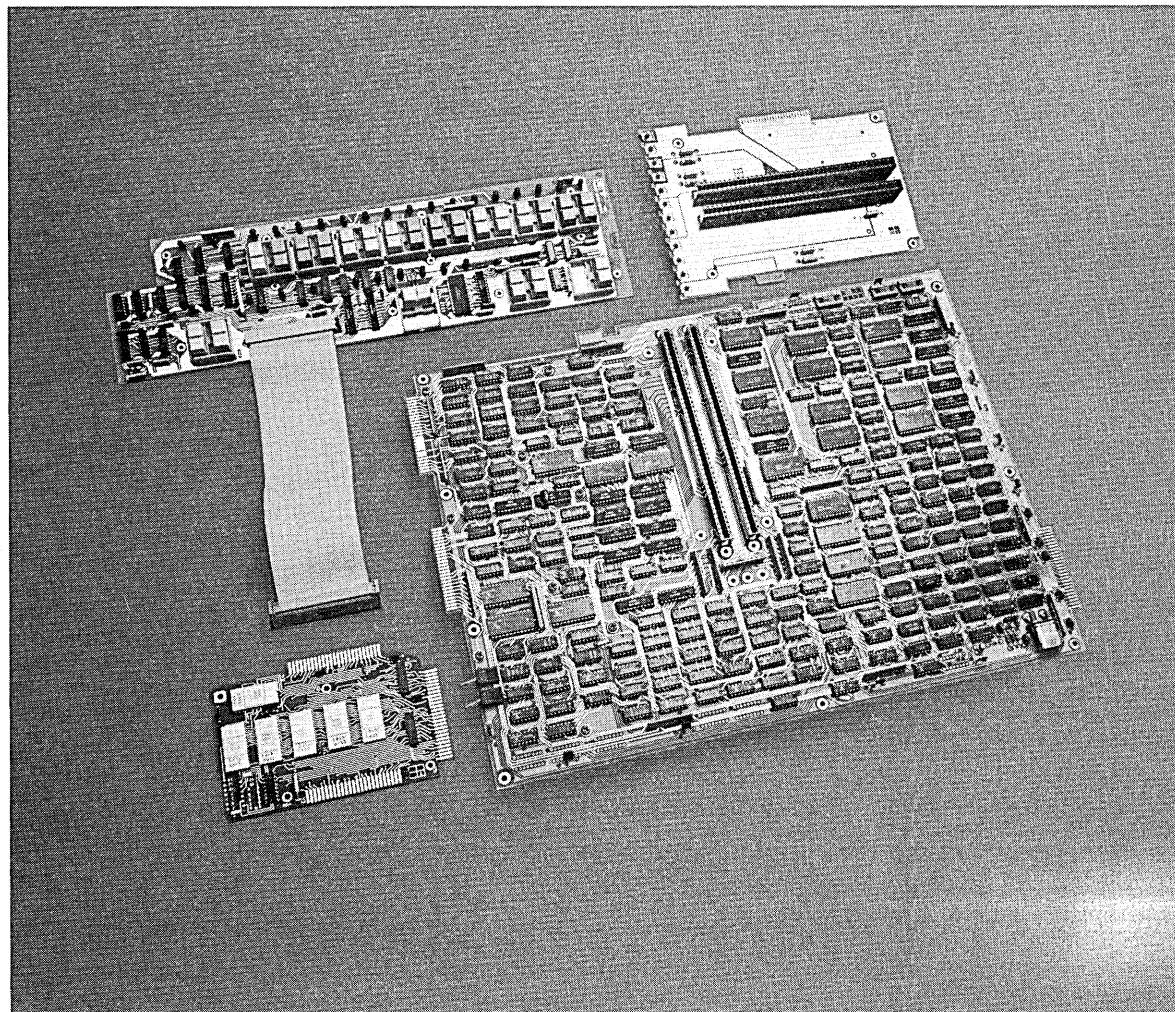

HP's new K-Series Minicomputer Components offer the speed, power and flexibility of 21MX Minicomputers in a form that integrates easily into OEM systems. The high-speed processor-on-a-board can be used with custom firmware and with a 21MX Instruction ROM as a full, microprogrammable minicomputer.

*The Hewlett-Packard Interface Bus (HP-IB) is Hewlett-Packard's implementation of IEEE Standard 488-1975, "Digital Interface for Programmable Instrumentation".

USER TESTED PERFORMANCE

Standard Oil of California provides next day shipment to customers.

The computerized corner drugstore relieves 90% of behind-counter clerical workload.

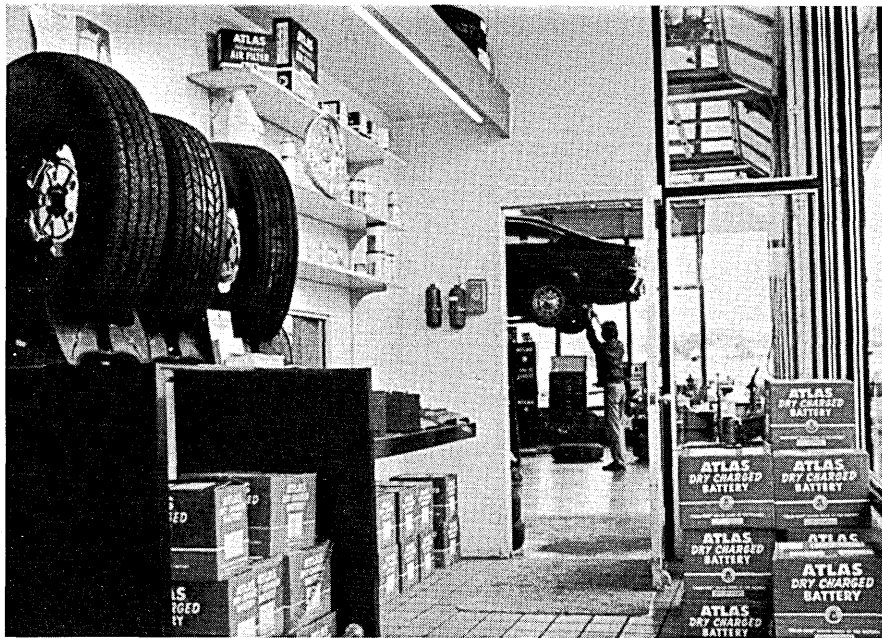

Standard Oil Company of California's computing resources now are available to their service stations and direct buying customers as they place phone orders for the company's products as a result of a recently launched distributed processing network.

SOCAL's Southwest area customers now can receive next-day shipment from the company's inventory of approximately 3,000 packaged petroleum and TBA (tire, battery and accessory) products.

In addition to providing the company's order entry personnel with on-line video display terminals, the multi-functional network controls a host of other operations: inventory adjustment, warehouse control, manpower projections and fill line scheduling.

Making this possible are two remote Hewlett-Packard minicomputers, the first of a national network of up to 18 planned distributed processors, initially running at two of the company's Southern California distribution points: its Los Angeles TBA warehouse and its El Segundo package petroleum warehouse.

The online, real time model HP 21MX minicomputers will be controlled by a HP 21MX central mini, which in turn will transmit confirmed orders and inventory data to a System 370/168.

The network, designed to en-

hance customer service was developed jointly by SOCAL and its systems contractor, MST (Management Systems Technology) of Chicago.

A Chevron dealer can place one phone order through the Los Angeles TBA warehouse for any of 1,200 TBA items and package petroleum products sold at service stations. The order can be delivered in one shipment within 24 hours.

Order entry personnel may access account files by customer name, service station number or account number. Displays alert them to special promotions and quantity price breaks. Products are accessed by either codes or a specially designed alpha technique that allows the same product to be identified by different input keys.

The computerized corner drugstore...

Computerized pharmacy is no longer a prediction. It is a reality. Management Systems Technology of Chicago installed its first Script Control™ dispensing system last fall at the Midwest's largest drug wholesaler.

Eight separate steps involved in dispensing drugs manually are reduced to a simple one step entry. As a result, approximately 90% of the pharmacists' behind-counter clerical workload is eliminated and up to 80

prescriptions per hour can be filled.

A Hewlett-Packard 21MX based Minicomputer System maintains a central data base accessible 24 hours daily and controls remote video displays and hard copy printers at subscribing pharmacies that will number 400 by the end of this year.

One of the HP 21MX Minicomputers with 64-K bytes of memory, together with varied HP peripherals, located at the central wholesaler site, can accommodate 16 pharmacies. Proprietary MST software was designed by pharmacists with pharmacists in mind. Druggists can interact with a Script Control system simply and with no previous computer knowledge.

For example, instantly after entering prescription number and drug identification, Script Control, in one step, accomplishes the following: prices the prescription; maintains the patient's profile; checks for drug interactions and allergic reactions; prints the label, receipt, alert messages and refill sticker; and prepares all tapes and documents for third party and state billing.

Savings derived from the use of Script Control are real and directly improve the profit picture for the pharmacist. Average third party rejection rate has been reduced to less than 1%. Headaches associated with constant price changes of pharmaceuticals are eliminated. Script Control uses the latest price and in addition lists generically equal drugs that when appropriate can be substituted at a cost savings to the patient.

The 22 functions of Script Control are under the complete control of the pharmacists. Changing from activity to activity is done simply by entering 3 keystrokes.

Byproducts of Script Control automatically filter into pharmacy record keeping and gives the pharmacist a new level of management control that was previously unattainable. Gross profit analysis, item movement and labor scheduling reports are three such examples.

Several years ago, MST also using HP computers, developed a predecessor system, CPS™ (Consulting Pharmacy System). Used by pharmacists who specialize in serving skilled nursing centers, CPS presently is processing more prescriptions than any other available computerized system.

©



Sales and service from 172 offices in 65 countries.

1501 Page Mill Road, Palo Alto, California 94304



re·li·a·ble (rĭ-lĭə-bəl)

Definition 1: that can be relied on; dependable, trustworthy.

Definition 2: Vistar/GTX

It's one thing to have a display terminal that is recognized throughout the industry for its performance and reliability.

It's another to have it at one of the lowest prices in the marketplace.

Yet that's exactly what the new Infoton Vistar/GTX has to offer.

GTX is a Teletype® replacement with an 80-character line and 24 lines of information. Its interfaces, both EIA and current loop, are standard with backspacing and non-destructive spacing available at no extra cost. Delivery is now!

(30 days ARO).

There's only one more thing you should know: the price. Only \$990 in quantities of 25.

Infoton

Second Avenue, Burlington, MA 01803 (617) 272-6660

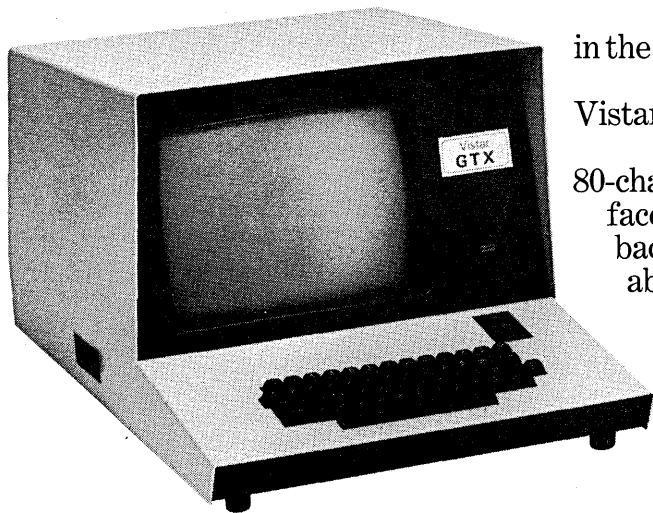

For full facts, just contact any of the Infoton offices below:
Bound Brook, NJ (201) 469-8188 • Gaithersburg, MD (301) 840-9270 • Los Angeles, CA (213) 380-0448 • La Grange, IL (342) 654-8686 • Cassleberry, FL (305) 831-3311 • Atlanta, GA (404) 455-0060 • Scottsdale, AZ (602) 944-5400 • Bellevue, WA (206) 454-9332

"As the first interactive small plotter, it was the only intelligent choice."

Problem: Until now, no small plotter could carry on an intelligent conversation.

Because most B-sized plotters have been pretty much the same: slow, unreliable, and dumb. Even with large off-line plotters you can wait hours, even days, for results ... and if there's a mistake—start over.

Solution: Tektronix' new microprocessor-based 4662. For interactive plotting, page scaling, digitizing, and camera-ready output. Just \$3995.†

The 4662 is the first smart buy among 11"x17" flatbed plotters. Its digital design and vector generation offer exceptional accuracy and repeatability without drift or slidewire dirt build-up. Its 1600-byte buffer lets the host work while the 4662 plots ... at speeds up to 22 ips.

It's the first B-sized plotter with graphic input. Digitizing capability and built-in joystick mean you can input corrections in seconds, experiment with designs, and run off camera-ready copies practically as fast as you load paper.

It's plug-to-plug compatible with virtually any RS-232 system ... from minis to mainframes. You can plot circles around any other B-sized plotter, for about the same price as the competition. For a demonstration, call your local Tektronix Sales Engineer, or write:

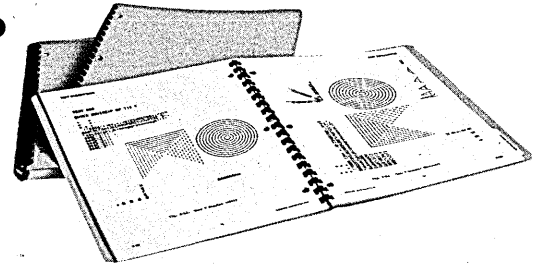

The 4662 contains its own character generator, alpha rotation, and page scaling, thus minimizing support software. Proven graphic and plotter software is provided by Tektronix.

Tektronix, Inc.
Information Display Group
P.O. Box 500
Beaverton, Oregon 97077
Tektronix Datatek NV
P.O. Box 159
Badhoevedorp, The Netherlands

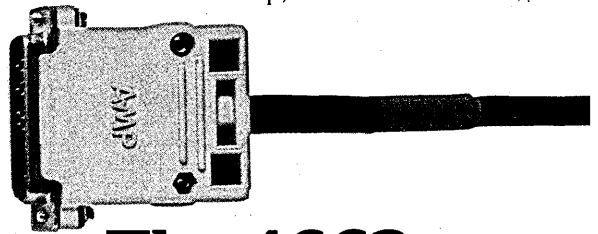

The 4662. Plug it in. It speaks for itself.



CIRCLE 54 ON READER CARD

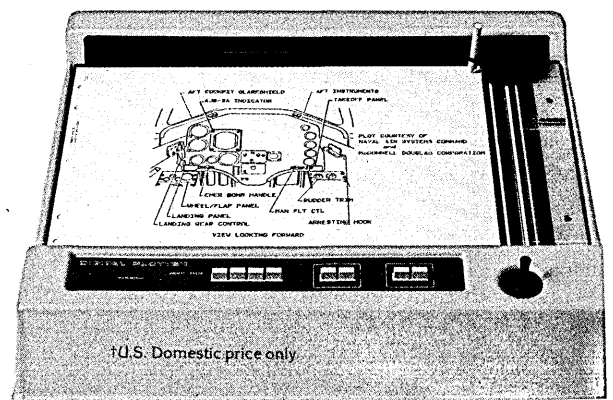

†U.S. Domestic price only

Editor's Readout

John L. Kirkley, Editor

Welcome to Your World



In one of Stephen Leacock's happily inane stories, the hero, in a burst of enthusiasm, "leapt upon his horse and rode madly off in all directions."

At this stage in its development, the worldwide computer industry appears to be gearing up for the same kind of whirlwind activity.

There's a great deal going on. Companies and governments around the globe are jockeying for position in the world's marketplaces. Almost every conceivable kind of arrangement—mergers, joint ventures, partnerships, licensing agreements, technology transfers—is being used to gain a competitive advantage. The result is a web of international relationships that almost daily becomes more complex. Just to illustrate the convoluted interlock between the Japanese computer manufacturers, the Japanese government, and manufacturers outside the country, takes a diagram that looks like a Pert chart for building the Viking lander (see page 94).

All of this activity provides the meat for this month's special feature section on the international computer industry.

For a quick briefing on who's doing what (or with) to whom, turn to page 56. There, Angeline Pantages, International editor, takes a deep breath and lets fly with two pages summarizing the frenetic maneuvers that characterize this tangled skein of relationships.

On page 60 you'll find shining examples of spleen venting by some of the U.S. computer industry's top brass; they're reacting to attacks on multinational companies by Congress and by governments abroad.

The bulk of this month's theme coverage is concerned with the industry in three major segments of the world: Western Europe, the Eastern Bloc and other communist countries, and Japan.

Our editorial aim in this issue is to present a comprehensive look at the wheeling and dealing, the innovating, the quest for emerging markets, that makes for a healthy and interesting industry.

But, like the dark, sounds of a bassoon against all these sprightly competitive movements, certain counterforces are slowing the action.

The most formidable of these is IBM. No matter where in the world the individual computer manufacturer is located, his marketing plans must first take into account what the giant is doing now and what he is likely to do. By dominating the international computer scene IBM is able to orchestrate the pace, the rhythm, and the long range strategies of the entire industry.

The customers, the users of computer gear, also help to slow the pace. Most are reluctant to convert from their present installed hardware and software to another vendor's offerings. Although in many cases there are good economic reasons for not switching, even more often the major factors for staying with good ole Brand A—even though Brand X will do the job twice as fast for half the price—are psychological rather than monetary.

Consumer caution is also fueled by the recent spate of defections—companies dropping out of the industry with the monotonous regularity of busby-hatted guards falling in the summer heat in front of Buckingham Palace.

But despite these checks, the industry's pace is accelerating all over the globe and the user stands to benefit.

For example, technological exchange between companies and countries has become commonplace (rumors that nations were going to hoard their technological know-how have proven unfounded.) Technological innovations, functional innovations like distributed processing, the push toward data communications . . . for the users it's all to the good.

It means he has more choices . . . if he exercises all his options. Like casting a cold, calculating eye on each manufacturer's claims and matching them against his own hard-nosed operating and economic criteria. By pushing for standards that will be beneficial without throttling technology. And by being a determined activist within his user group. (We'd also recommend that, following the example of several U.K. organizations, user groups representing various manufacturers band together to tackle common problems—there's not only safety but a great deal of strength in numbers.)

Finally, the user can help himself and his company by keeping current on the industry's progress on an international as well as local scale; hence this issue and our continuing international coverage.

Welcome to your world.

© R. J. Inc. 1976

The International Computer Industry

by Angeline Pantages, International Editor

The international computer scene is a confusing mix of conflicting images: multinationals helping the balance of trade but coming under attack at home, both competition and alliances between vendors, both protective nationalism and cooperation between countries. The only common denominator is IBM.

Watching the movements made by companies and governments in the computer industry worldwide is like watching 15 chess matches going on at the same time. Every match has one thing in common, though. IBM seems to control both queens on every board.

Wherever they exist, mainframe manufacturers are trying to capture more of their home markets, while at the same time scrambling to expand their foreign penetration. Many are buying into whatever technology, companies, joint ventures, and partnerships they can. Japan's Fujitsu is forming agreements in the U.S., Spain, Brazil, East Europe. Hitachi is looking for partners to handle some of its systems overseas and seems quietly to have bought into many smaller companies. England's International Computers Ltd. is foraying into the U.S. on its own, while pushing into other new markets through acquisition. CII jumped out of bed with Unidata to make U.S. and other international connections through Honeywell Bull.

The U.S.'s Univac found one partner in Scandinavia and is looking for more. Control Data is playing the joint venture game with countries and companies everywhere. Honeywell is doing an incredible balancing act between its affiliates, subsidiaries, and licensees in West Europe and Japan.

Along with the mainframers, there are ex-mainframers like Philips and Datsaab and countless numbers of other companies scurrying to latch on to a share of high growth markets—minicomputers, microcomputers and microprocessors, word processing,

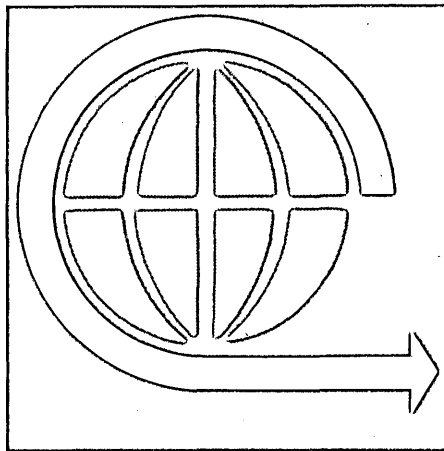

terminals of all kinds, small business systems, peripherals, communications gear. What they don't have, they too buy, license, or form partnerships to get.

Upset with the Japanese and U.S. domination of microcircuitry, the European giants in that field are all talking to each other about cooperative developments—U.K.'s GEC, Plessey, Ferranti; France's Thomson CSF; Germany's Siemens; Holland's Philips. At the same time, many of them are signing agreements with Intel, Motorola, National Semiconductor. (The Intel 8080 seems to still make the world go round. It accounts for 70% of the microprocessor business.)

Governments and commissions of major industrialized nations and even many developing nations are trying to ensure that their homelands will have a strong foundation in computer technology, if not lucrative pieces of their own and foreign markets. They are

encouraging those partnerships, providing subsidies and intensifying "buy national" pressure—Germany, France, U.K., Japan. Where there is little or no computer industry, foreign firms are being invited into joint manufacturing ventures—Spain, Iran. Or stiff import and business restrictions are making it mandatory for foreign commerce to do something to contribute to the balance of payments—Brazil, India.

The East Europeans are looking for all the technology, know-how, licenses, and partnerships they can get. They are gearing up their own industry, their own product line, to supply the bulk of their own needs and to compete at least in the "third world" markets. Western vendors are chomping at the bit of government restrictions on East-West trade, trying to get into Eastern Europe before it becomes too self-sufficient.

In the midst of all this, the U.S. vendor, who has captured large percentages of the most lucrative foreign markets, tries to compete. He is partner, licensor, and/or benefactor—providing jobs and export—and at the same time he is the enemy. The great American system of high finance and entrepreneurialism has produced a mass of technology and companies that has swept the world. Where else would a Viatron have received \$40 million to play with? Wall Street mentality (here today, gone tomorrow, yawn) exists nowhere else.

Why should everyone scramble to spread to foreign markets? Growth is the first commandment of the businessman. When a market—geographic

or product—plateaus, he must head out to new frontiers. Another major fact, particularly for the computer market, is that the home market is often too small to support the economies of scale needed for increased profitability, if not survival. If IBM has already set up shop there—as it has in 132 countries—the local market available to anyone else is automatically smaller by more than half.

It's costly to establish a fully supported operation in any country. What is the attraction? Look at the never ending stream of prognostications coming out of every research firm, government office, and company. Microprocessors are supposed to be an \$800 million business in Western Europe within a decade. In France, the data communications equipment demand between '75 and '78 is supposed to be \$365 million, double that of the previous three-year period. Banks there will be adding 3-4,000 terminals between now and '78. NCR alone sold 1,350 point-of-sale terminals and 70 computers to French retailers in the last quarter of '75.

Brazil, with 3,000 computers (mini to large-scale) installed, is supposed to represent a \$300 million dp market next year. And the little country with the world's second biggest market, Japan, expects the number of large-scale systems there to double by 1980. Its banks, department stores, and even gas stations are going hell-bent for on-line systems.

Some of the Middle Eastern countries, like Iran, are trying to leapfrog the more developed nations in their application of technology to information systems. They're talking about sophisticated satellite-based communications, national education networks, and on-line systems with closed-circuit tv to track the progress of their development projects in real-time.

Spain too is moving rapidly. It has one of the two international electronic funds transfer experiments operating between a department store and banking branches.

European and Japanese common carriers are trying to resolve the communications problems that hamper cross-boundary and high speed communications. All are working on digital networks of some kind.

Americans like to talk about the world's lag behind the U.S. in adoption of new ideas and in applications development. This has very often been true, but can't be generalized. For instance, retail systems are rated two to five years behind the U.S. in Europe; however, in countries like France and Switzerland, with their giant 25-, 50- and 100-lane hypermarkets, the gap is closing. Even in the U.K., where small stores predominate, cooperatives are beginning to go heavily into point-of-sale systems.

Where the U.S. early on moved to automate labor-intensive functions to cut labor costs, the rest of the world had far lower wage standards and so

delayed, but now is beginning to move because of inflation. Some foreign government structures are such that computerization is highly sophisticated. For example, Sweden's hospital systems are among the finest in the world. Similarly, banking in Scandinavia, U.K., France, and some other countries has been ahead of that in the U.S. in certain applications and in on-line developments because it is organized on a national, rather than state, basis.

Plug-compatible peripherals were an American development, and while the often conservative overseas user was understandably wary about the long-term viability of these suppliers, the products are now commonplace in his installations. In fact, British Airways stunned IBM by going completely to plug-compatible peripherals and farming out some of its equipment maintenance to a third-party firm.

In one thing there is no difference around the world, in the buzzwords and hot topics. "Distributed processing" is being implemented and examined everywhere—Australia, Japan, Germany (where Herr Nixdorf says he invented it years ago). Data bases are a major concern. The cost of paper vs. COM is a common discussion, as are minis, midis, maxis, micros.

Perhaps one of the best indications that the world outside the U.S. is gaining speed, is that big U.S. vendors have lately been unveiling their major products in Tokyo, London, Paris, or at the Hannover Fair in Germany—before they see the light of day here.

In the succeeding pages, we have tried to describe some of the major policies and major companies that are involved in these incredible chess matches around the world. One doesn't like to dwell on it, but some of the players somewhere will have to lose. And the user will have to pray that he bet on a winner. *

WORLDWIDE COMPUTER INDUSTRY INSTALLED BASE		
(\$ Millions at sales value)		
Country	12/31/75	12/31/80
United States	\$39,750	\$ 62,700
Western Europe	22,050	38,800
Other Countries*	11,600	23,050
	\$73,400	\$124,550

*includes Japan. Figures for these years published by Japan's Ministry of International Trade and Industry are \$7,161M and \$18,230M, including office computers.

Source: Sperry Rand

The U.S. Multinationals

by Angeline Pantages, International Editor,
and Nancy Foy, European Editor

They are fighting pressures on three fronts: from the competition; from foreign governments; and, perhaps the most important, from the U.S. government.

Because of their size, depth of product line, and early development, U.S. computer manufacturers continue to play an important role in the data processing business in other countries. Today many of them are fighting pressures on three fronts: from the competition; from the governments of other countries, which are trying to develop or maintain independence in manufacturing while at the same time protecting their home markets; and from restrictions placed on them by our own government. They are fighting these pressures in numerous ways, with varying degrees of success.

Burroughs Corp.

Burroughs has 3.6% of the West European market and about the same in Japan. It has practically nothing of the German market. Despite the love its users hold for the product line and their intense loyalty to Burroughs, some feel that it, like NCR, suffers from its success in the accounting machine and banking market. These successes diverted management attention and style from the gp computer market long after most competitors (and Burroughs' own development people) were thinking in systems terms. Perhaps that is an image that lingers after it ceases to be true. Burroughs thinks so, pointing out that it did \$687 million overseas last year (a \$500 million increase in 10 years), and 85% of that in data processing equipment.

It points out that what were accounting machines are now computer-based systems like the L series, of which it has sold 125,000 worldwide. It is building computer sales from that base. Overseas, it has installed more than 600 B-1700s and more than 800 of its 500 and 700 series of general purpose computers. As of mid-July it had orders or letters of intent for more than 1,700 B-80s from international customers.

Burroughs' shares in Europe run about 4-7% in countries like the U.K., France, Holland, and Benelux. Its less than 1% share of the German market is attributable simply to lack of com-

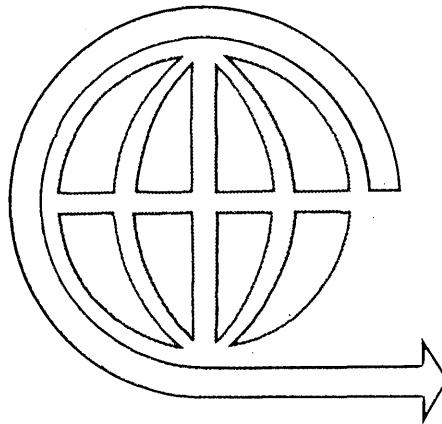

mitment. The German organization has been undermanned, underfunded, and undersupported, while management changes have been frequent. Burroughs promises that this situation is now changing, stating that it has had a policy of "assuring successful operation and support of Burroughs equipment wherever it is installed . . . a plan based on available resources and local market potential." But, it says, this has "left selected international markets relatively underdeveloped by the company. . . . In many of these markets, the company has taken or is taking significant steps to greatly increase our share. . . ."

Burroughs is now beginning to establish sales and support teams for targeted industries in and across many countries. About one-third of its foreign revenues come from banking, of course, with other major industries being manufacturing, wholesale, retailing, and education.

Its most significant and prestigious banking order has been to supply the new international SWIFT banking network with the computer switching complexes in Holland and Belgium, plus concentrators and some SWIFT interface devices to the nearly 300 member banks around the world.

A slip of four months in the software schedule, which made headlines but doesn't upset SWIFT, is the only thing that's gone awry, and Burroughs

is confident that the order will open doors to more foreign banking business.

Burroughs' revenues in Japan should climb, thanks to that country's liberalization of the computer business. It was able to buy almost all remaining shares of its company there, and will step up marketing efforts. As for other markets, the firm boasts about 30% of the growing Brazilian market, for which it locally manufactures printers, terminals, and components. It also keeps the French, British, Belgians, Canadians, Mexicans, Filipinos, and Germans happy by manufacturing equipment in those countries.

Burroughs has no entangling alliances and has been quiet since it tried to buy or merge with ICL a few years ago. It does not subscribe to the Honeywell theory that a firm needs 10%-12% of the world market to survive and it will continue its own selective way.

Control Data Corp.

Control Data Corp. is unique among the world's mainframers with a very mixed bag of tricks that give it the economies of scale it needs to survive in this scrambling industry. Its international volume isn't gigantic—\$409 million in 1975, which is about 30% of its total computer revenues (47% if you disallow military business). It operates in 32 countries with 8,000 people. While it has a few peripherals and media plants on foreign shores, its only large mainframe plant outside the U.S. is in Canada. That gives it some political edge in Commonwealth countries but nowhere else. It has only a few percent of the world market in value of installed base, and is listed as "others" in Japan.

Still one has to look at what Control Data is doing. Contrary to any opinion it is very much in the mainframe business. Executive vice president of marketing operations, Vern Sieling, noted that it has to be in the systems business to accomplish its aims—to provide the "full breadth of services and products" worldwide. But he emphasizes that

CDC's computer business is entirely based on large-scale systems, with other products and software built around that. The targets are scientific and complex large-scale applications and networks in five or six industries; petroleum, utilities, manufacturing, education, data centers, and "large-scale computing," meaning applications like modeling, weather forecasting, etc. No credit cards, no billing, no payroll.

On this basis, CDC has a better market share than it seems. Sieling noted in the 7600 class, CDC has 50% of the world market, and a "significant percentage" in the next class of systems below that. Its international computer sales are about \$165 million.

Those large-scale systems are used in its proliferating service bureaus and big Cybernet network around the world. (Cybernet has six centers in Europe, one each in Canada, Mexico and in Australia.) Many of the same applications developed for the service centers are used by its system customers and vice versa.

Where CDC is not established in computer marketing, such as Japan, or where the nation's computer demands for large-scale systems are not yet great, as Brazil, CDC enters with services and education, another sizeable business worldwide. Its international data centers currently produce over \$50 million in revenue annually.

In peripherals, it has defrayed the cost of producing its own systems peripherals by selling them to mainframers all over the world and to end users of other mainframers (predominantly IBM-compatible peripherals). Internationally, peripheral sales are running at \$135 million. CDC is the largest oem peripheral manufacturer in the world.

It has joint ventures in peripherals with NCR and ICL (Computer Peripherals Inc.), Honeywell (Magnetic Peripheral Inc., which CII-HB may join), and Romania. It says there will be more partners from East and West in CPI and MPI. It has licensing agreements for peripherals with Poland and the German Democratic Republic (GDR). Terminal ventures or licensing agreements are with Iran (plasma display terminal manufacture), Hitachi (terminals development), GDR (cartridge disc drives). And it has teamed up in the media and supplies business with ICL (Control Dataset Ltd.).

CDC has also poured vast sums into a few major applications projects, aimed at selling both hardware and services. The most important is its commercial offering of PLATO, the computer based education system developed at the University of Illinois. It's offered internationally to government, industry, and educational institutions both as a

system and as a service via the Cybernet network (May, p. 183). Many nations like Russia and Iran, are anxious to lay the groundwork for countrywide PLATO networks. CDC has a technological exchange program with the U.S.S.R., in which this is one of the projects. As a by-product of this effort, CDC and Iran jointly will manufacture the plasma display terminals (used in PLATO) in Iran. They'll be exported for educational and other applications, as well as used in Iran's PLATO network when it is developed.

As noted elsewhere on these pages, CDC feels East Europe is the next big marketing opportunity for U.S. computer firms after Japan and West Europe. Its ventures and agreements noted show that. But CDC feels that the U.S. restrictions on trade and technology exchange keep American firms from realizing potential there and has been unflagging in its efforts to change Washington's attitude. The firm has an agreement with the German Democratic Republic to market peripherals for the model of the RIAD series it produces, the 1040. About 50 to 55 1040s have been installed, so CDC has prospects for its wares but hasn't applied to the U.S. government for a license for any of them. It expects the licenses will be a problem.

Honeywell

Honeywell Information Systems Inc. does more than half of its \$1.324 billion revenues (fiscal 1976) overseas. How this will change with the drop in shareholding of what is now CII-HB from 66 to 47% is unclear. The money from the sale of this share will be shown on the books for some time. Honeywell's arrangements with CII-HB and NEC-Toshiba are discussed elsewhere on these pages.

Among the countries where the firm does business directly or through 100%-owned subsidiaries, the pictures look like this: U.K., 8% (by value) of the computer market; Italy, 20%; Australia, 14%. Its Japanese licensees are said to have 17% of that market, while CII-HB enjoys 12.7% of the West European market. The world seems to be involved in developing Honeywell's product line. CII-HB manufactures for all of Honeywell the Level 61 and 64, including two communications oriented models not available in the U.S., the 64/30 and 50; HIS Italia makes the Level 62; and Level 66 needs in Europe and other countries are met by a plant in Scotland, although CII-HB ultimately will manufacture it. And NEC-Toshiba contributes some hardware and software technology, plus components and peripherals, to the Honeywell effort. Then Honeywell has combined with CDC in a joint peripherals company, which CII-HB may join. And

since it bought the Xerox computer base, it is talking to Rank Xerox about an arrangement to handle the small foreign base. (We don't think Honeywell could get out of the business even if it had to because no one could possibly untangle these alliances.) What this does say is that Honeywell is looking for every possible means to control costs, get cash, and increase the share of the market for the Honeywell line.

IBM

IBM got more than half its revenues (\$7.27 billion of \$14.4 billion in 1975) and half its profits from overseas business. With its 130,000 people abroad, 21 plants and 10 laboratories, it has amassed a share of the world market that starts at more than 50% in most major countries. It has almost total dominance in many smaller markets.

The exceptions to the rule are Japan and Great Britain, where entrenched local competitors and "buy national" policies have encouraged IBM to keep a low profile and be content with less than 40% of the market. IBM's market shares there may be lower in percentage, but it clearly has the most profitable position—a kind of cream-skimming approach that may be IBM's answer to market-domination accusations in other countries. Rather than fight the government and local authority edicts, as Honeywell does in the U.K., IBM simply concentrates on the commercial user and encourages government users whenever they are willing to buck the tide (which is fairly often).

More than a quarter of IBM's overseas revenues come from the German market, followed by France and the U.K. IBM has factories and development labs in most major European countries, and is serenely immune from the union problems that bedevil Honeywell, Burroughs and ICL and the U.K. market, having virtually no union members, though the unions continue to try for recognition. The company's ability to move projects quietly from one country to another is an irritant to governments and the EEC, but its no-layoffs policy has helped keep the union at bay. The EEC investigation of IBM's dominance has so far had even less effect on IBM than the U.S. antitrust suits.

The main threat to IBM's autonomy in the European computer market comes not from governments or unions but from the increasingly mature and demanding users. Led by the U.K. Computer Users Association, most European IBM user groups are stronger and noisier these days, and can sometimes impose their wishes on the vendor.

IBM worldwide is beset by the elements. Countless strategies and poli-

MULTINATIONALS

cies and proposed policies are aimed at its head. The problem is that it is like a young Muhammad Ali, with stinging punches and lightning fast footwork. It ducks and someone else gets the blow. Just when companies like Fujitsu and Hitachi are about to announce IBM-compatible systems in the low to medium range, IBM comes out with the startling and unfolding (you haven't seen anything yet) 138 and 148 systems, with their unprecedented "more for less" strategy. Such a move also hurts the likes of Siemens, in the throes of deciding its own direction; that's

just as IBM startled RCA in the 360 vs. Spectra days. ICL's plans for models below the 2960 also must have been affected.

This kind of IBM move means the giant is getting tougher. Competitors tell us that it has been fighting fiercely, doing things it has never done before. Some foreign users are getting products on "trial," we're told; this has certainly been true in the U.S. with trial memory. Many say unbundling, which should increase to the operating system level, is used as a negotiating point rather than a firm policy. In fact, the full price of the 138 and 148 may not yet be visible, if one considers increased unbundling. Users everywhere

had better get negotiators in.

Competition and governments are fighting back on many fronts besides through nationalism and subsidy. Third-party leasing firms are catching on heavily in countries like Japan and Australia. (IBM countered in Japan with both three- and four-year contract leases, acquiescing to Japanese wishes for shorter leases.)

More plug-compatible peripheral companies are popping up, like Nippon Peripherals Ltd. in Japan, which is exporting to the U.S. and Europe. Memorex, Telex, CalComp, and Storage Technology all have international outlets. In fact, the howls from IBM Europe a few years ago,

"Don't Box Us In"

In recent years, the attacks on multinationals at home and abroad, plus the worldwide counteroffensive against American dominance of the computer industry have led executives from U.S. computer firms to speak out.

Frank Cary, chairman of IBM, noted in his remarks before the last annual meeting that Japan "has embarked on a policy of building the data processing business into a major export industry. It is a program reminiscent of their successful efforts to expand their automobile and shipbuilding industries." Besides telling the Justice Department that it has strong competition, Cary seemed to be pointing out to Congress that impediments to IBM, and U.S. multinationals in general, would hurt our bobbing balance of payments picture.

Picking up on Cary's theme, John Opel, IBM president, was more pointed, telling security analysts this spring that in Japan "loans and subsidies have not been under \$135 million per year since 1972. . . . Furthermore, these Japanese companies with government subsidy can settle for profit levels below anything tolerable to a risk-taking open competitor. . . . We know the Japanese government's objective is to make computers and the 'knowledge industry' a national monopoly. And they have good technology."

He also pointed out evidence of economic nationalism elsewhere, particularly in Europe. But he allayed any Wall Street fears that the EEC investigations of IBM will seriously impact it. "It's true that IBM's business operations in Europe are being looked at by an investigative body of the Common Market organization. We've answered all their questions. We know of no Common Market country that has found fault with the way we do business and we're in

hopes that the EEC will soon reach the same conclusion."

Paul Lyet, chairman of Sperry Rand, keyed the National Computer Conference in New York in June and was quick to bring out the problems of economic nationalism. David Anderson, assistant general counsel of Sperry, expanded on the



JOHN R. OPEL

"No Common Market country has found fault with the way we do business."

"European Challenge." He quoted estimates that European governments in the last 10 years have directly provided more than \$1.4 billion in support of their computer industries. This technology has become a "symbol of a nation's technological power. . . . Since the possession of technological power is thought to be essential to national sovereignty, it is therefore necessary to have a domestic computer industry independent of the United States.

"Those who think that this line of argument is absurd might do well to remember that in 1966 the U.S. government initially refused an export

license for two large-scale computers destined for the French Atomic Energy Agency. Whether this decision was good or bad at the time is immaterial. What is important is that this action dramatically demonstrated, in the eyes of the Europeans, the power of the U.S. government to interfere in the national policy of another industrial country solely through the control of high technology."

Anderson traced European developments and noted, "I believe that the European computer industry is alive and well today; that when measured against national objectives it has a very good chance of success in the long run, and that in the near future it will become a force to be

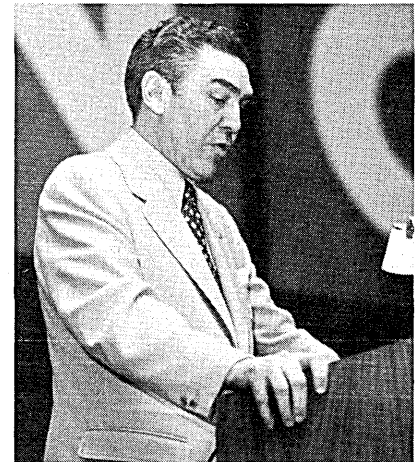

WILLIAM S. ANDERSON

"The favorite whipping boys of leftist politicians and all manner of government bureaucracies."

reckoned with in world markets—this to the potential detriment of the American computer industry and the U.S. balance of trade."

How is the U.S. government responding to this "European challenge"? "In my opinion, by actions which will encourage these countries

were what led IBM to come up with leasing plans for peripherals and to announce the 2319 to fight the competition.

Government policies around the world are demanding a number of special clauses in their contracts, basically aimed at IBM—such as guaranteed maintenance of systems with foreign peripherals; separate contracts and bidding for computers, terminals and minicomputers, etc. France does it. Brazil has its version.

Standards-making bodies are making noises about a counteroffensive against IBM de facto standards. The German government has been discussing with IBM the idea of preannounc-

ing its interface information to German vendors who want to attach their equipment to IBM systems. (Everyone wants that.) Nixdorf is one of the influences in this move.

One of the problems with standards organizations everywhere is that IBM dominates them. IBM is fighting hard efforts of common carriers and others in Europe, Japan, and Canada to adopt a more sophisticated version of the IBM synchronous data link control protocol. IBM may be overridden, but it will drag its feet on it, just as it has with other standards it disagreed with.

One observer made the most conclusive comment of all on this. Everytime a country tries to lock its doors to

foreign companies, it forgets that "IBM is already inside."

NCR

NCR doesn't look like much on the international shares charts, 1%-2% in most European countries, 2.4% in Japan. In fact, its performance in Europe led a financial analyst to write, "NCR has no basic position in the European computer industry. It would seem to have the opportunity to move small computer equipment in line with an industry trend toward distributed processing. NCR's lack of currently suitable products, a significant and specialized computer sales force, and a dp orientation in Europe suggest no

to continue their efforts and which will help them be successful. Our multinational companies are subjected to continuing public abuse," he noted, "while animosity in other countries is directed at foreign (read 'American') multinationals. They promote and protect their own."

Anderson slapped at the periodic proposals in Congress that seek to tax foreign income and eliminate or cut back the foreign tax credit. He noted that "our export programs are being challenged as tax 'loopholes' exactly at the time when other countries are expanding theirs. The Domestic International Sales Corporations (DISCs) are a subsidy, but their benefits only partially offset the European practice of rebating the value-added tax on goods exported. Congress now is trying to eliminate or restrict DISCs. This must be resisted.

"Finally there is a little-known proposed IRS regulation under consideration (Sec. 861.8), which if adopted would have the effect of encouraging U.S. companies to move research and development activities offshore . . . at least one country would be glad to help . . . France has reportedly funded a multimillion dollar research facility near Paris in an effort to induce foreign companies to locate their R&D facilities in France."

NCR's chief executive, William S. Anderson, has also unleashed ire over economic nationalism and the treatment of multinationals, "the favorite whipping boys of leftist politicians and all manner of government bureaucracies." Generally, as a businessman, he is "as much concerned with the drift toward socialism, which we are witnessing in many countries today, as I am with the more widely feared problem of inflation. . . . I am also disturbed by the increasing tendency, especially in Eu-

rope, of labor unions and governments to demand a role in the management of a company's operations. Coupled with an ignorance of the most basic economic principles, this development is reducing management's flexibility at a particularly critical time."

If the major U.S. executives are



WILLIAM C. NORRIS

"Continued confused and over-restrictive U.S. policies on exports will lose U.S. manufacturers the peripheral equipment opportunity."

worried about what nationalism, socialism, and seeming U.S. unwillingness to "protect its own," Control Data Corp. is concerned about the restrictions prohibiting U.S. firms from trading freely in East Europe. The theme is the same, "Don't box us in."

Control Data executive, Robert O. Schmidt, emphasized that the computer markets of Western Europe, Japan, and the United States are reaching a point of saturation—leveling off to the growth of 10% annually. The next big growth market is the

Communist countries, not South America, not the Middle East. CDC wants to be in that market.

Chairman William Norris has spearheaded the CDC fight against U.S. government restrictions against trade and technology exchange with Communist countries. At a press conference showing the East German RIAD 1040 and CDC peripherals last year, Norris noted that "Continued confused and over-restrictive U.S. policies on computer equipment exports will lose U.S. manufacturers the peripheral equipment opportunity, just as it caused the loss of the major part of the mainframe market in the past. Restrictive policies provided the incentive to Socialist countries to accelerate development of their own computer industry. . . ." (See p. 75 for an article on East European developments.)

Norris ticked off loss after loss of business for U.S. industry, not the least of which was a deal to build a \$75 million printed circuit board factory in the U.S.S.R. CDC couldn't pursue it because "We were discouraged by U.S. government representatives." A French firm received the contract.

Seeking a better defined and more aggressive program between East and West, Norris has proposed three main actions:

1. Establish a broad, continuing program for collecting and disseminating information on Socialist technology and business opportunities for the U.S. offered by such technology. (The U.S.S.R. spends more a year for R&D than the U.S., CDC notes.)

2. Change the present adversarial relationship between U.S. government and business into a partnership.

3. Establish a definitive and aggressive blanket program with the U.S.S.R. for technology exchange.

Don't box us in. . . . *

MULTINATIONALS

startling near-term changes in its competitive posture."

The firm does \$2.16 billion in revenues a year, 52% or \$1.1 billion overseas. About 44% of its total is dp equipment, with an additional 20% coming in the form of services: data centers, computer and business equipment maintenance, and training. NCR's European chief, Clarke Reynolds, says that 75% of the \$500 million in European revenues are from data entry and computer systems (including the 299, 399, 499 systems). Those figures aren't gigantic, but if one looks at what NCR has been doing—in terms of new systems announcements (Criterion), new orders, and shares of market in specialized industries, the outlook is more positive. It has announced more new products in the last 48 months than in its entire history, and more are coming.

Reports are that Criterion made an impact in Europe this spring; NCR had a strong surge in sales in Germany during the spring months, and the rest of its European sales force there picked up on the mood. More Criterion models, at the bottom and top ends, are expected, and NCR will be announcing more terminals and a "direct processing system" to replace the 299/-399/499. NCR has 36.6% of the point-of-sale terminal market in Western Europe, where more than 18,000 are now installed. (Other leaders are Singer, which has been sold, and Anker, which is in trouble, so NCR may pick up shares.) Its position in banking terminals and office computers is low (about 7th or 8th), but it remains to be seen whether its new products will improve the situation.

Reynolds is quick to admit that internationally NCR has been slower to shift from mechanical to electronic manufacturing, a fact that keeps productivity down. But the mix is changing; the mechanical, standalone equipment declined 66% last year. And NCR is making some moves to upgrade or change its sales force and improve the systems engineering to sales ratio from 1:1 to 2 or 3:1. This is a problem that has bedeviled everyone from Burroughs to Olivetti.

Reynolds emphasized that NCR wants to sell total systems in targeted industries—banking, retail, wholesale, medical/education/government, and manufacturing. But "total" doesn't necessarily mean covering all of the user's data processing. NCR is willing and able to tie into any competitive cpu; 90% of its point-of-sale systems in Europe are linked to a competitive computer. A good example is a multi-\$million order from Takashimaya De-

partment Store, where it is putting in an entire pos network that will ultimately be linked to Fujitsu computers.

NCR does some interesting business with data centers. For example, it installed 200 terminals and two NCR 300s in a French center owned by 17 savings banks. In Denmark, toy-maker LEGO is buying 12 model 8200 minis to install around the world, to link to three Century computers. Also, JCD Data, there, is a service bureau that is putting a network of model 8200 minis into customer sites (a new trend among service companies) for local processing and on-line links to its three Century systems.

NCR is moving into the supermarket and "hypermarket" business where it exists, too. (Hypermarkets are giant stores that sell everything and have dozens of checkout counters.) It installed its first hypermarket system in Switzerland in 1974, with 25 model 255 terminals on-line to a 726 mini.

The company's success in banking, retailing, and other markets varies from country to country. In Spain, it's big in banking, not retailing. In Germany, it's the reverse. In Switzerland, it says it is strong on all counts, a good, if not large market because of the purchase orientation.

NCR's links to other mainframers naturally include CDC, with which it is working cooperatively on computer development, plus ICL, a joint partner in Computer Peripherals Inc. NCR statistics overall may not be extremely impressive, but they are a company to watch in several industries.

Univac

Univac is enjoying a self-proclaimed image of being the "only stable alternative" to IBM in Western Europe, making hay on the problems of the ex-Unidata partners, and the fact that Honeywell is involved now with so many disparate lines, and that Burroughs and ICL have selected strength only in certain markets. Univac has 7% of the West European market (by value) of entry level and general purpose computers behind IBM, CII-HB, and ICL. Internationally, it is number three, just after Honeywell, if CII-HB is fully included.

Univac has 20,000 employees in 32 countries contributing to its \$600 million in overseas revenues (fiscal year ending March). That is 42% of Univac's total, but if military business is excluded, the overseas contribution is 50%. It contributes to the balance of payments in Germany, Canada, Scotland, and Japan, by manufacturing there. The 90 Series is made in Germany and Japan. In Japan, Univac has a joint venture with Oki Electric for manufacturing and has minority interest in a marketing arm, Nippon Uni-

vac, which contributed \$250 million to Univac revenues last year.

The firm is making many moves to strengthen its position in various countries and is very willing to take minority interest in new ventures. It joined forces with Saab in Scandinavia, creating Saab-Univac. This company took over the D series of computers made by Datasaab (which retained its terminals and other products) and while the commitments to those customers are being fulfilled, it is the Univac line that is being marketed. Univac claims the venture is a success, pointing to the fact that 11 of the 12 model 1100 systems sold in Europe last year were sold in Scandinavia, where the firm is now number two. Datasaab's terminals, strong in banking, are often sold in concert with the Univac gear; that relationship could become a marriage, we hear.

Univac also has submitted a proposal to build a manufacturing plant in Spain, in a joint venture with the government and financiers there. It has already sold 100 systems in Spain, which is fast developing into a very exciting market.

As noted, Univac is very interested in a joint venture, minority interest, with Siemens, but so far Siemens isn't listening. Univac would love to put all that RCA experience to use in Europe. Another possibility is ICL, but even with its ex-Univac management team, it is showing little interest in a Univac deal.

By industry, Univac claims to be the second largest supplier to commercial banks outside the U.S. It has historically had a good share of the airlines market, and currently has total data processing in four overseas airlines with systems in an additional 31. Every passenger flying out of Scandinavia (SAS) or Germany (Lufthansa) carries a Univac ad on his boarding pass. The model 494-based reservations systems gained a reputation for cost effectiveness once the teething troubles were over in the '60s. Most of the airlines are worrying today that Univac will eventually succeed in killing off the 490 Series, which already has a lively secondhand market. Univac is trying to remedy that with new airlines software modules for the 1100 Series.

Other industries include discrete manufacturing (where Univac is stepping up its efforts), state and local government agencies such as law enforcement and social welfare (inherited from the RCA deal), education, printing and publishing. Univac is into distributed processing ("We feel we're in it, whatever it is"), having announced a strong element in its UTS terminals. It will announce its philosophy and position on a "system network architecture" this year. *

Western Europe's Computer Industry

by Angeline Pantages, International Editor, Nancy Foy, European Editor,
and Andrew Lloyd, European Contributing Editor

The course of Western Europe's computer industry has been marked by nationalism, government subsidies, alternating cooperation and competition between companies, plus at least one magnificent international failure.

In the beginning of the computer industry revolution, American explorers, called vendors, sailed to the most promised of the far-off lands to sell their wares. They landed first in a place called London, not far from Plymouth, and from there pushed on to new nations on the continent. Today, many of these colonies are in revolt. Many states have joined together and call themselves the Common Market. Their declarations call for computer independence.

What follows here is not more Bicentennial fever, but a discussion of the efforts by three nations, three major manufacturers, and one community of nations to control their own destinies in computer technology, its production, and its application.

With about the same population as the United States, Western Europe contains about half the computer base installed in the U.S. It talks a great deal about being as big a market one day. But the problem is that it cannot be viewed as *one* market.

Market opportunities

Western Europe is trying to find out today where cooperation can create better opportunities for its industry and where economic nationalism will have to take its course. It has suffered in the past from lack of a system like that in the U.S. that will financially support new companies. Some of the programs have been short-sighted, not taking advantage of market opportunities. Its efforts to create one computer company, Unidata, out of three strong-willed companies was a pipe dream.

Some countries are now individually turning their efforts to the real markets of the future. We haven't covered all of Western Europe or every major firm in what follows, but the trends indicated here may help put future events in perspective.

United Kingdom

Americans don't buy many European computers. Europeans would prefer to buy fewer American computers. One factor that often escapes the notice of traveling Americans, though, is that Europeans don't really like buying from each other, either. Though the express purpose of the European Economic Commission is to create a "common market" this goal has been singularly unsuccessful in the computer realm, a situation that grew more visible when Britain joined the EEC.

France and Germany already had government support and some kind of preference policies for their own computer-makers; the main effect of Britain's inclusion in the EEC was to make these policies more visible. The British

supported their computer industry with research and development grants, and they said so, in public, in 1970-71 parliamentary hearings. The policy then was to give preference to ICL unless a competing foreign system was at least 10% cheaper or better. Today the 10% business has evaporated as a policy, but continues as a rule-of-thumb. (Similar policies in France are also stated, though the Germans have tried to keep their computer support in the realm of grants, and have now given notice to Siemens that mainframe development grants will peter out after 1980.)

Britain's development grants are stopping too, and like the Germans, British government officials are paying more attention to software, training and standards. But the buy-British

Western Europe's Installed Computer Base (\$ Millions at Sales Value)		
Country	12/31/75	12/31/80
EEC Countries		
West Germany	\$ 5,650	\$10,100
France	4,550	8,300
United Kingdom	3,900	6,650
Italy	2,050	3,950
Netherlands	1,100	1,750
Belgium	550	950
Non-EEC Countries		
Scandinavia	1,600	2,650
Spain	1,000	1,450
Switzerland	900	1,500
Other Europe	750	1,500
	\$22,050	\$38,800

Source: Sperry Rand

Western Europe Market Shares Held by Major Manufacturers (general purpose computers by value)		
Manufacturer	1975	1980
IBM	52.6%	51.0%
CIH-HB	12.7%	11.7%
ICL	9.7%	10.5%
Univac	7.0%	8.1%
Siemens	5.8%	5.6%
Burrroughs	3.6%	3.1%
CDC	3.6%	3.1%
NCR	1.4%	1.0%
Others	3.6%	5.9%
	100.0%	100.0%

Source: Quantum Science Corp.

WESTERN EUROPE

phenomenon continues to bedevil foreign competitors: Honeywell recently sued a water authority that bucked its own technical committee's choice of Honeywell and decided on an ICL system. Honeywell's system was marginally cheaper, had been in the field longer, and was therefore surer.

Honeywell tried to make the point that it too is a U.K. manufacturer, with a computer manufacturing plant in Scotland. The public argument did nothing for the U.K. "benefactor."

The nationalism phenomenon is now creeping into the near-sacred academic environment. Cambridge University spent countless man-months pushing through the purchase of an IBM 370/155. Six months after they bought it, IBM virtually obsoleted it with the 158 and 168 announcements. The Computer Board, which holds the academic purse-strings, has taken note of this and other events, and the general trend is to quiet flag-waving. London University, which wanted to buy CDC and IBM computers, was recently turned down. "Buy ICL" was the word.

On the other hand, the House of Lords forthcoming procurement of a computer system may be a test of the de facto "Buy British" policy. If the procurement is carried out in the open, it may lead to political debate on the

issue. It is said that the IBM system in the running is cheaper and more readily available than the ICL system. Arguments and counterarguments should keep the issue boiling for years throughout the U.K.

International Computers Ltd.

International Computers Ltd. enjoyed its best year ever in 1975, with \$427 million in revenues and \$169 million in profits, up \$36 million over 1974. About 60% of those revenues came from the U.K. market, where ICL enjoys about 35% of the total computer market and IBM comes in second with 30%. ICL has 9.7% of the West European market, but as is traditional, its strength in foreign revenues comes from the Commonwealth countries. The firm is located in 40 countries.

ICL went through considerable turmoil to reach its present profitability and current product line. In 1972, it hired Geoffrey Cross away from Univac to become its managing director, a hard-nosed executive who set about to cut staff (34,000 to 28,000 in four years) and raise productivity. Emphasis was put on customer support to correct ancient ills and clear the way for the conversion users would face in going from the 1900 series to today's 2900 series.

Currently, the 2900 is suffering the usual birth pains, particularly on software implementation, and ICL is still suffering the problems of melding old

and new staff and decreasing the company headcount. Next year the government subsidy ends, (\$62 million in the last two years), although the "Buy British" pressure, if not a policy, will still exist. ICL is not cash-rich, although it claims it supplied the majority of the \$300 million needed to develop the 2900 out of its own pocket. It also was able to come up with \$2 million for the first payment on Singer's international operations.

ICL has resisted attempts by other mainframers, such as Burroughs, to buy or merge with it, although the rumor continues to pop up that ICL and Siemens have been talking. (Everyone's talking.) ICL is very much for joint ventures in the costly peripheral development area, having combined with Control Data and NCR in Computer Peripherals Inc., taking a one-third interest. CPI is said to be a \$60 million operation, will have R&D and manufacturing facilities in the U.K. ICL also merged its ailing media and supplies operation Dataset Ltd., with that of CDC, forming CDC Dataset.

The acquisition of Singer gets ICL into many new markets and increases its foreign penetration to 50% of the combined revenues. It also adds strength to its growing base in the small computer and intelligent terminal markets. ICL's foray into the U.S. to market 2903s and 2904s in New York has met with minor success, attributable, many say, to minor investment.

EUROPEAN ECONOMIC COMMUNITY

"No real change" is the reaction of industry and EEC sources to the June news that Altiero Spinelli is leaving the EEC. The commissioner ultimately in charge of computer policy, Spinelli resigned because he was elected to the Italian parliament on the Communist ticket that made major advances in the recent elections there. Spinelli's replacement in Brussels is another less-than-youthful Italian diplomat named Guazzaroni from the Italian foreign office. Since the terms of all the commissioners are reviewed when the new EEC president Roy Jenkins takes over at year-end, Guazzaroni's effect on the computer policies is expected to be minimal.

Those policies have themselves shifted slightly in the past year or two, with the concept of a giant Euro-competitor to IBM somewhat be-dragged after the breakup of Unidata. Although the Euro-competitor idea is still viewed as a desirable ideal, it has been accepted as no longer a practical goal. Like national governments in Europe, the EEC has turned its eye a little more to the leverage available in standards, networks, soft-

ware and peripherals.

Microprocessors have gained EEC attention, helped along by a spate of promotional articles similar to those the U.S. has seen this year and by news that those terrible threats, IBM and Japan, are both working on large-scale integration. (In the U.S. the best way to get government funding for a project used to be "The Russians are working on it." In Europe the similar message is "Japan" or "IBM.")

The likelihood of Europe achieving a coordinated effort in microprocessors, though, is low. The big companies like Plessey, GEC, CGE, or Siemens originate in the cumbersome electrical/telephone field, burdened with the bureaucracy of monopoly and government customers. Then, the small firms that might otherwise give it impetus have virtually no access to the kind of money it takes to develop such products. And the markets are fragmented by national and industry borders.

So Europe has no Silicon Valley to compete with the United States. No quantity of paper policies or even

government subsidies can rectify this situation. There will be European microprocessors (Siemens, GEC and Plessey have them in the works, as do others), but at the moment Europeans as well as Americans tend to identify their micros by Intel model numbers.

Telecommunications and standards are the areas where EEC money may talk loudest. There's also a growing awareness in traditionally disagreeing countries and PTT administrations that they will lose business if they can't get together quickly.

In software, the EEC is stressing the development of a standard real-time language, and greater software portability. Tasks proposed thus far include the design and development of portable compilers, of a "software writing language," of subsystems for data base management and transaction processing, and of conversion tools. Five special applications software projects have also been identified. Software firms are all for this effort, and many are camping on the EEC doorstep in Brussels, waiting for the funds to back up the idea. *

The proof of whether it is serious will come when it implements its plan to expand into other cities and introduce larger models of the 2900 series there. Too, the recent purchase of the Cogar plant in the U.S. could mean a site for 2903 and 2904 assembly. ICL is acquisition- and agreement-minded, so we're led to believe that they may have another announcement soon.

France

The French have a reputation which is widely envied in Europe for successful working relationships between government and industry. The relative harmony of government-industry action is often held responsible for France's staggering growth over the last 20 years. In the last ten years, in fact, the country has had the highest growth rate of all western developed nations—a statistic which has to be taken seriously even if all its industrial plans have not met with unmitigated success. The growth has meant a high

standard of living for its citizens, healthy profits for its industry and a certain measure of international respect despite the traditional French insularity in which the country is probably its own worst enemy.

With the restructuring of its computer industry—the second in 10 years—France's industry-government partnership has again come under the spotlight. First and foremost, will the government's initiatives—setting up the new CII-Honeywell Bull combine, plus boosting the peripheral, minicomputer and component industries—pay off? Secondly, what are the prospects for foreign firms of gaining or maintaining a foothold in France (or a stranglehold as in the case of IBM)?

The current climate in French computing—like the record temperature this summer—is hot. Politicians are staking their reputations, the state is staking its money, and industry, which is revamping itself, is staking its future on the new look. Naturally, plans to

become a major force in computing are being taken very seriously.

France's aims for the home market are relatively well defined and ambitious. For the mainframe business, CII-HB is expected to be shipping and installing more computers, in value, than IBM France by 1980. Current estimates are vague, but CII-HB's installed market here is about 27%, with IBM at 54%. (Much evidence shows that 1975 was a bad year for CII and HB. IBM seems to have cleaned up in the uncertainty over the merger.)

In "peri-informatics" (minicomputers, peripherals, and terminals), French aims are to double the home industry's share of the French market from 30% in 1975 to 60% in 1980. The turnover for this sector should be nearly \$650 million then.

French plans for international export of the computer products are less clear. Language difficulties impede free advance into the English-speaking countries, even if the products are

COMPETING WITH IBM

INTERNATIONAL BUSINESS MACHINES IBM	SOME OF THE WELL-KNOWN SMALL SYSTEM COMPETITORS			
	Data-Saab	Nixdorf	Olivetti	Philips
System/32	D15	8835, 8870-2	A7/85	P-410
System/3	D15	8870-1, 8870-4 8870-4 8870-6 8870-6; 900*	A7/90	P-410 P-450 P-450 P-455

*West Germany only

Information extracted from the *Auerbach EDP Notebook International*, Auerbach Publishers Inc., 6560 N. Park Drive, Pennsauken, NJ 08109

INTERNATIONAL BUSINESS MACHINES IBM	MAJOR FULL-LINE COMPETITORS		
	CII-HB	ICL	Siemens
System/32	HB 61/58		2903/20
System/3	61/60		SBM Sys 10
4	61/60, 62/40		2903/20
8	62/40		2903
12	62/40, 60		2904
15			
System/370	62/60, 64/20	7720	2904, 1901T
115	64/30		1902T
115-2	64/40	7730	1902T
125	64/50	7730	1902T
125-2	66/05 and 10	7735; IRIS 45	1903T
135	66/05 and 10	7735	1903T
135-3	66/05 and 10	7740	1903T
138	66/10 and 20	7735; IRIS 45	1904S
145	66/10 and 20	7735; IRIS 55	2960
145-3	66/07, 10, 20	IRIS 55	2960
148	66/20 and 40	IRIS 60	2960, 2970
155	66/17 and 40	IRIS 60	2970
155-II	66/17 and 40	IRIS 60	2970
158-3	dual 66/40		TR440
158 MP	66/27, 60, 80	IRIS 80	dual 2970
165	66/27, 60, 80	IRIS 80	2980
165-II	66/27, 60, 80	IRIS 80	2980
168-3	66/27, 60, 80	IRIS 80	2980
168 APS			
168 MP	dual 66/60		dual 2980
195			DAP

These comparisons are of a general nature and do not reflect a system's strength in any one particular application. For instance, Honeywell's time-sharing systems offer greater system performance in a heavy time-sharing

environment than their IBM equivalents. Honeywell claims that a 66/07 can match a 370/158-3 in time-sharing. We show it versus the 370/148 in an effort to show which systems the manufacturers bid against each other.

Information extracted from the *Auerbach EDP Notebook International*, Auerbach Publishers Inc., 6560 N. Park Drive, Pennsauken, NJ 08109

WESTERN EUROPE

competitive enough to go. However, old ties with the U.S.S.R., the Middle East, and the French-speaking ex-colonies in Africa have led to considerable French success in these areas, and efforts there are likely to be increased.

Some targets have been set. CII-HB is to export three-quarters of its production by 1980, and to achieve half its sales outside France. Most of those sales should come from the Honeywell line, with the CII Unidata products being sold seriously only in France, the U.S.S.R., the Middle East, and Africa.

What does French computing have to offer France's market—the third or fourth largest in the world? Of course,

CII-HB, with its \$800 million turnover would rank high in the DATAMATION "Top 50" charts (June, p. 48) if it were a U.S. firm. The country's service industry ranks third worldwide close behind Japan. Investment in services per person is second only to the U.S. Its largest service firm, CISI, would rank even with Telex in the "Top 50," or fourth in the service company lists. Three other service companies would also make that list.

In the minicomputer field, the French government has just pushed through a merger combining CII's minicomputer interests with Telemecanique Informatique, resulting in a company, SEMS, with a \$70 million turnover now and pitching for \$220 million in 1980. A second merger should occur to produce another mini-

computer and peripherals company of similar size.

Financial backing, industrial credibility, and perhaps most importantly, political influence, is provided for France's computer industry mainly by two multi-\$billion electronics firms. Thomson CSF and Compagnie Générale d'Electricité were shareholders in the original CII. Thomson now holds the whip hand in minicomputers with control of the CII minicomputer interest in SEMS. It also has a subsidiary in the terminal business, T-VT, and a service bureau, SMM, which has links with Computer Sciences International.

CGE holds 19% of Machines Bull, which in turn holds 53% of the new CII-HB combine. CGE's telecommunications subsidiary, CIT-Alcatel also owns

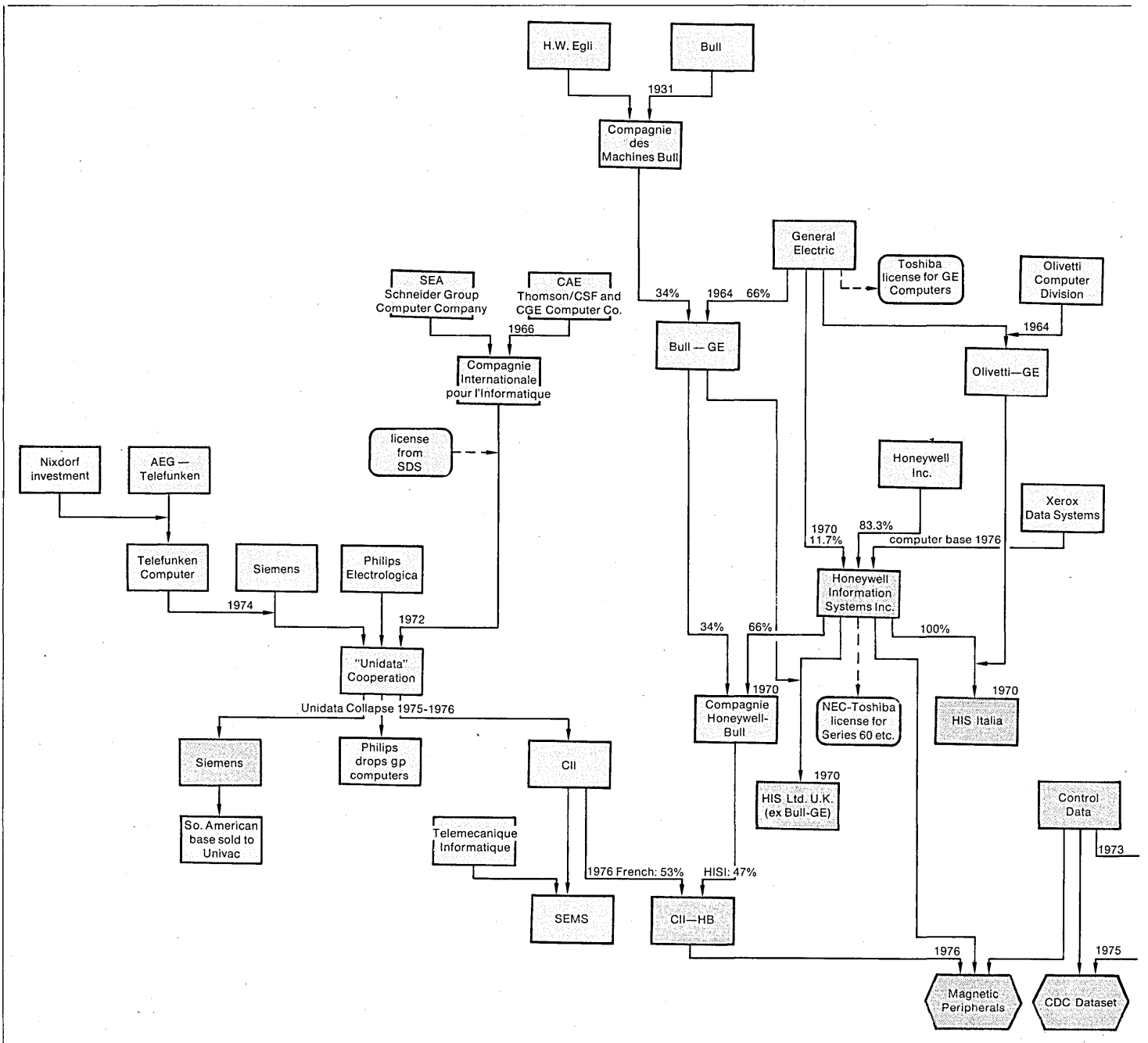

a terminal company, Transac (allied with Incoterm), and large pieces of Sintra, a \$40 million peripheral and terminal company, and gsi, a \$50 million service bureau.

CGE is the firm likely to put together another minicomputer company, combining its properties with two other firms in the field, Sintra and Intertechnique. If the latter two are willing, it should happen later this year.

Several other firms of note are on the scene, some of which may figure in the French push to consolidate its computer industry. The 8,000-man firm SAGEM makes terminals, data capture devices, teleprinters, and floppy discs. CSEE, heading toward a \$75 million year, makes minis, peripherals, and terminals, and is allied with SAGEM in international markets. LogAbax is a

\$50 million international firm making printers, terminals, and small business systems; it has begun having some success in the U.S. and has some licensing agreements in Poland, Germany, and elsewhere.

The balance of payments considerations drive France to goals not only for mainframes and "peri-informatics," but also in components. The industry in France has a \$1.1 billion a year market, with about \$400 million being spent on semiconductors. Although half the industry is foreign financed, the import/export balance is only slightly negative. International agreements seem to be the rule on this front, although the government may offer considerable aid to increase the industry's viability after a poor year in 1975. Thomson CSF's subsidiary, SESCOSEM,

has just concluded an agreement with Motorola for the manufacture and sales of its 6800, plus know-how exchange. Thomson has also joined forces with the French atomic energy agency for the design and development of special purpose integrated circuitry.

While Thomson is likely to be the mainstring in semiconductors, further associations are likely on the European level. Philips talents in this field are also of interest to French firms, for instance.

The French government has made it quite clear to industry that it has four years to make good. Both CII-HB and the "peri-informatique" sector (again peripherals, terminals, minis), must be operating in the black by 1980. Until that time, the industry will be cushioned by guaranteed orders and con-

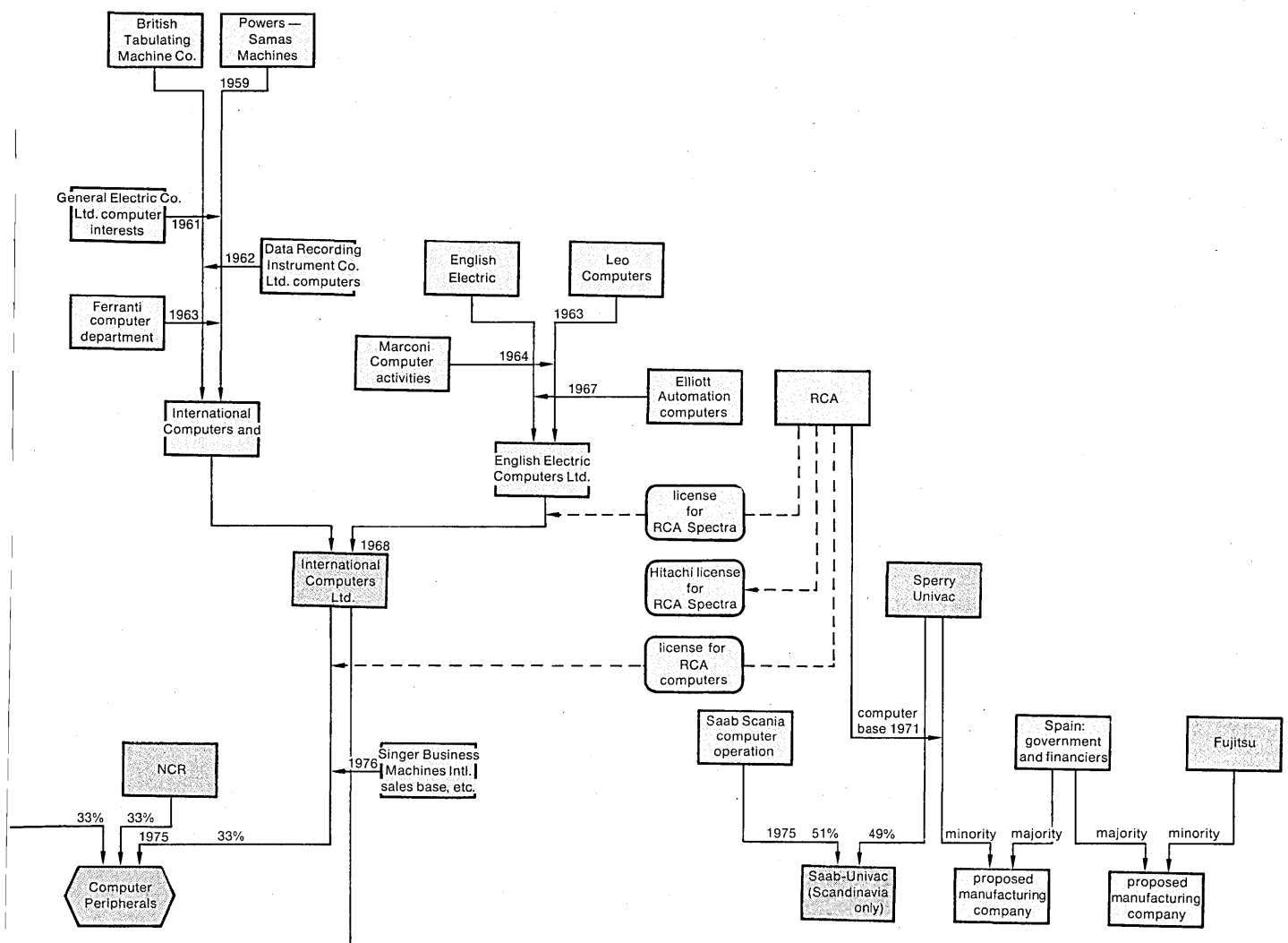

WESTERN EUROPE

siderable amounts of state aid.

Foreign industry operating in France clearly has no such privileges—and indeed can expect some problems. Implicit in the CII-HB aim to capture half the French market by 1980 is a reduced share of potential business for IBM. The attitude of the French toward IBM is ambiguous.

IBM is, according to the industry ministry, in the top six of France's largest exporters. On the other hand, its imports are so high that the import-export balance is only barely favorable. Taking into account the funds repatriated to the U.S., its total operation apparently gives a negative balance.

But IBM employs around 20,000—making a particularly big contribution in the underdeveloped area of France. It is believed that the company's latest decision to make the 370/138 in Montpellier rather than in the U.K. is to provide more work for the under-utilized Montpellier plant.

France, sometimes accused of being over-tolerant of IBM, has at least reduced the IBM share of public sector market from around 55% six years ago to 35% of installed kit now. Moves against IBM dominance are also taking place in the development of independent expertise and standards in the network areas (where European moves are also afoot). It has also become official government policy to ask for separate tenders for mainframe and peripheral configurations. This policy is just being implemented and few positive results are expected for a year or two.

The country is conscious of IBM's entry into satellite communications, and at ministry level it is felt that no large computer organization, by implication CII-HB, can afford not to participate in satellite technology. Hypothetical developments would include perhaps an association with the GE-HIS time-sharing network operation.

In the field of computer assisted PABX's, IBM's French-developed 3750 has met with reasonable success—maybe not as high as the U.K., but some estimate 25% of large PABX orders over the last two years. The French, however, have a company of their own, Beumont Schneider, which has made a similar impact on the French market.

Aside from IBM starting from such a huge base and benefitting from all the influence a large company in France can bring to bear at all levels, there are other foreign firms involved. Rules in theory are different for EEC-based suppliers than for others. But in both these groups, the French have a tough reputation. One top European manufac-

turer, at least, regards France as the hardest country in Europe to get public sector orders.

The official and understandable attitude is to give preference to companies manufacturing in France, which gets IBM nicely off the hook. But there seems to be little doubt that government policy will be heavily influenced by demands for protection of the domestic industry throughout the formative years after the restructuring. Digital Equipment's proposed factory at Annecy in France provides a confusing example. After what was apparently a good deal of preparatory work with the French authorities, Digital announced earlier this year that it was to set up a 120-man final assembly and test factory in Annecy. The announcement was made with the encouragement of the government and regional development board but subject to a favorable verdict from the French committee responsible for approving foreign investments.

Permission to go ahead was then delayed on the request of the French Industry Ministry. The official statement from the Industry Ministry was that the application was lacking details. The ministry later complained more explicitly of lack of cooperation from DEC Europe, comparing the Annecy proposal unfavorably with Hewlett-Packard's successful venture down the road at Grenoble. They said the project as it stood was not welcome because: first, the setting did not help regional development plans for industry; second, a third of the employees would be coming from across the Atlantic; and finally, the assembly nature of the operation gave it little added value.

This opposition has apparently struck DEC as something of a surprise—and indeed industry ministry officials earlier this year criticized foreign computer manufacturers precisely for *not* having a manufacturing operation in France, DEC among them.

If this impasse continues, obviously DEC may take the easy way out and just look elsewhere. From what we hear, there are other U.S. firms in "high priority" peri-informatic sectors that are having similar difficulties entering France.

Compagnie Internationale pour l'Informatique—Honeywell Bull

The new company, CII-HB, is substantial. It would leap straight into DATAMATION's "Top 50" charts at the number seven spot if it were a U.S. firm. With an \$800 million turnover now, it is promising a 1980 turnover of \$1.6 billion, with half the amount sold outside France.

With the infusion of government

subsidy monies (\$280 million), the promise of \$900 million in French government orders over the next four years, and other grants for the CII side of the product line, CII-HB is going to have to produce. It is also going to have to cope with many product lines: CII's IRIS series, the Series 77 (nee Unidata 7000), leftovers of the earlier GE and Honeywell lines, and the Series 60.

Fortunately, in terms of production, HB was making only the Level 61 and 64 of the Series 60 line, so it doesn't have to cope at that end with too many computers. It has prospects of manufacturing the Level 66, now produced for Honeywell in Scotland, but this is quite far off, since 144 Level 66s must be imported over the next two years. Most think any French manufacturing plant for this level will really be for the next generation of equipment.

CII-HB markets the Honeywell products in 49 countries. Honeywell Information Systems, Inc. markets its computers directly only in the U.K., Ireland, Italy, Iran, Turkey, Yugoslavia, Australia, India, Southeast Asia, South Africa and the South Pacific. However, HISI owns 47% of CII-HB's international operations as well, and we understand that the shares ultimately will be reallocated, that the French ownership of the international company will diminish to less than the majority it now holds. (It will retain 53% of the French arm of the company.)

CII-HB has 12.7% of the European market. It now holds more than 27% of the French market, with goals of 50% within the next few years. Obviously, much will have to come out of IBM's hide, but the other mainframers will have to be pushed farther and farther to the back of the bus. Their hope is that the private sector, which the government can't pressure so directly, will maintain its business-is-business attitude and choose competitively. Of course, IBM has a great stronghold there and enjoys the majority of the French market. Its own manufacturing, development and sales force rivals that of CII-HB in France.

While most think that the Honeywell move to give up majority interest in Honeywell Bull in order to achieve the merger was a sound one, the move has its detractors too. There are those who say Honeywell is starting a withdrawal from the business and that CII-HB will be nationalized when the next government is elected. Honeywell's feelings are that it was enriched in cash and gained a bigger market than it could have expected alone. Nationalization would gain France nothing, losing it a market for its products in the U.S. and elsewhere. One detractor feels CII-HB will be Unidata all over again,

(Continued on page 75)

The era of personal programming is here.

And TI's new low prices prove it.

SR-56

Key programmable

\$109⁹⁵*

SR-52

Card programmable

\$299⁹⁵*

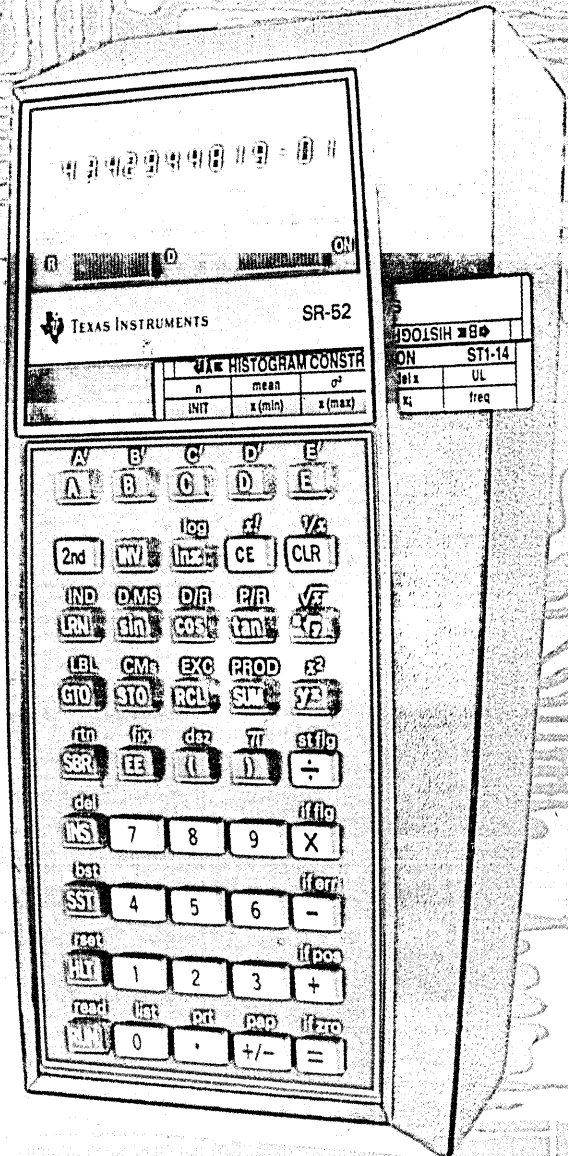
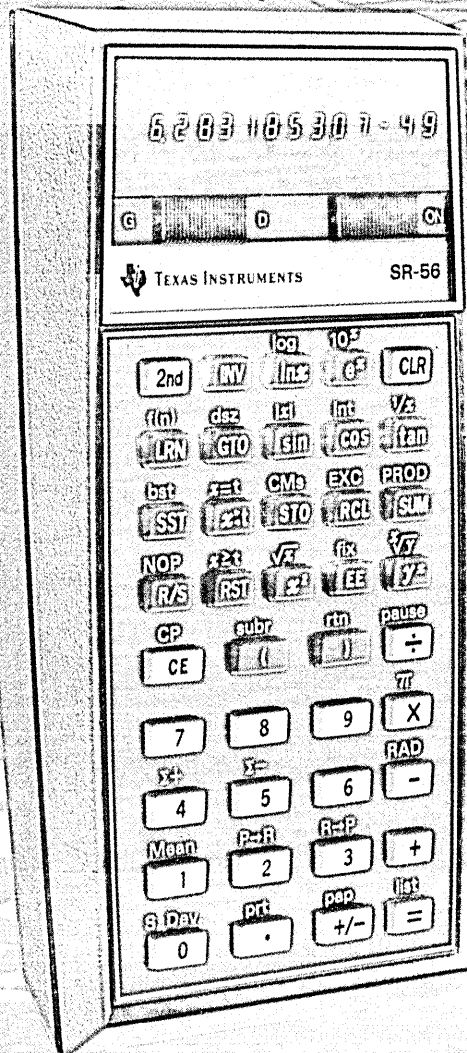

*U.S. suggested retail price. may vary elsewhere

**Long calculations. Analytical math.
Time-consuming and error-prone to do by hand.
Costly on a computer.**

An SR-52 is a better way.

If you're a professional—or studying to be one—then chances are you're deeply involved with: Optimization. Mathematical modeling. Iteration. Data reduction. Projections. What-if matrices. Risk analysis. Forecasts. Worst case analysis. Probability.

If you have the time, you work them out. Or, you get in line for computer time, then wait. So, more often than you'd like to admit, you rely on your intuition. Make an educated guess. Or do some ball-park figuring.

But you can change all this. You don't need to guess. You can *know*. Because personal programmables help you cope with more data, explore with more insight, far more successfully than ever before. You make better decisions, chosen from more options—better decisions founded on a broader data base. More decisions. Faster. On the spot.

**A card programmable
that offers outstanding
capability at an extremely
attractive price.**

Without compromising quality.

TI's advanced technology and manufacturing know-how are the keys to the SR-52's exceptional value.

You can process data or perform complex calculations automatically. Load the card and put its contents into program memory. Key variables directly into the program — or into the 20 data memory registers (up to 60 in certain cases). Run a program as often as needed. Change values of variables as often as you desire.

Program memory and data registers in abundance. Data recording, too. The SR-52's 224-step program memory uses merged prefixes, so each step can hold two keystrokes. With this capability the SR-52 can handle programs you may have thought required a computer. Although the basic 20 data registers are usually more than adequate, you can use up to 40 additional registers. (28 in program memory, the 10 pending operations registers, and 2 more.) And you can record up to 28 data registers onto blank magnetic cards. Read them back in later.

Computer-like branching. The SR-52 offers seven types of unconditional branching. And 10 conditional branches each with three ways to address: absolute, label, or indirect. That's 37 different branch-

© 1976 Texas Instruments Incorporated

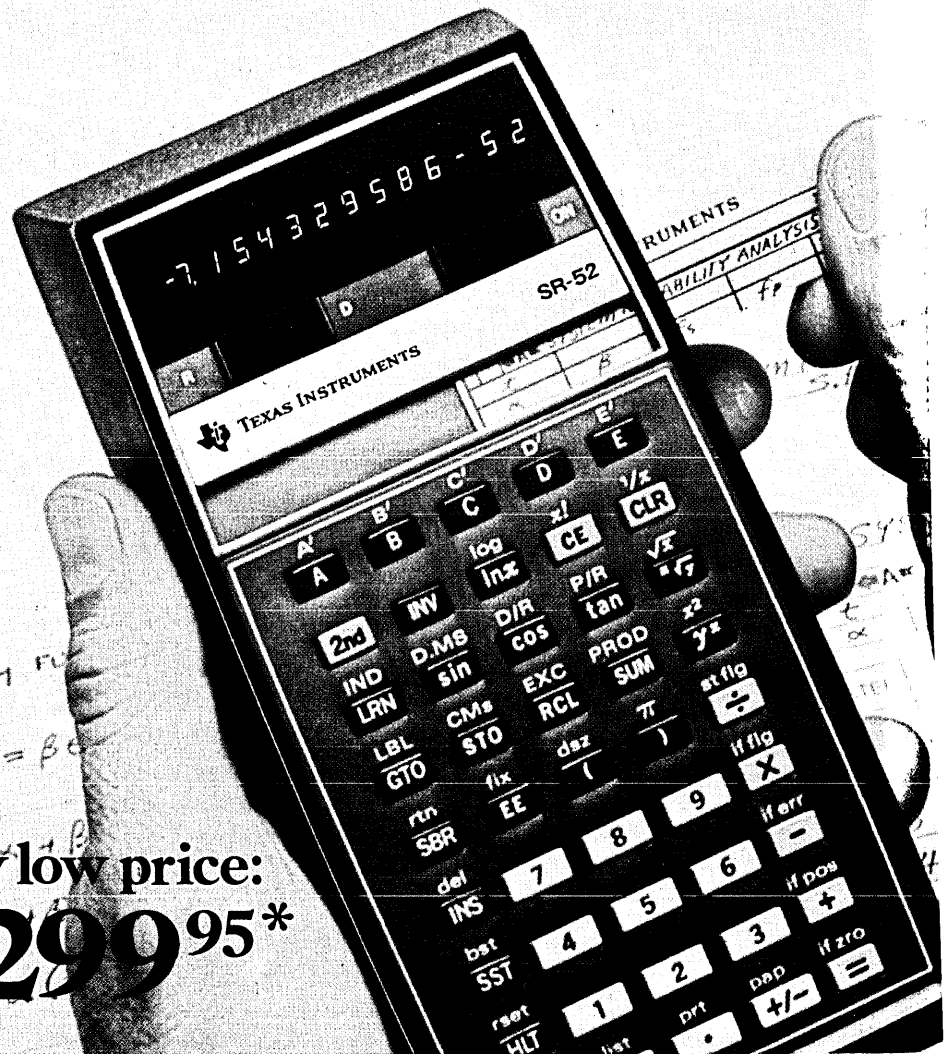

At a new low price:

Circle reader service number 200 **\$299.95***

When professionals need decisions, programmables deliver. Anywhere. Anytime.

"The SR-52 saves me time in designing attenuators—pi pads, T-pads, H-pads, etc. I key in the impedance and amount of loss and, in seconds, the SR-52 tells me what resistors to use. Without a calculator, it might take hours to optimize these values. The SR-52 is very easy to program—it works very naturally. It's cheaper, of course, than using a time shared system. It's also quicker and more convenient—not having to go to a terminal and access the big computer. And many things—formula translations, for example—are just easier to do on the SR-52."

M. H. Kindermann
Engineering Staff
Supervisor
AT&T Long Lines
Kansas City

"I'm using the SR-52 to handle long calculations in determining optimum locations in a warehousing system. I need lots of data storage—plus I can copy the magnetic cards and send them to our clients for use on their SR-52. We're also working on an energy model—a huge computer program with thousands of calculations. Here, I'm using the SR-52 for pre-processing and post-processing data to get it in a more usable form—to get my data out faster. The SR-52 is very powerful—and convenient. It's always available. I can take it anywhere."

Marleen Mandt
Operations Researcher
Stanford Research
Institute
Menlo Park



"Inserting a lens in the eye, usually at the time of a cataract extraction, has become an important surgical technique. The lens must be precise. This is where my SR-52 has proven invaluable. First the length of the eye is measured by ultrasound. Then I incorporate this and other data into formulas which I've developed and programmed on the SR-52. Of course, I share my programs with my colleagues. And, my approach is an integral part of my lectures."

Richard D. Binkhorst, M.D.
Ophthalmic Surgeon
New York City

"Calculating a gas pipeline network for 200 homes under construction takes hours of tedious work. I developed a program for my SR-52. It makes all the necessary iterations—and gives me pressures and flow rates. Now I do in less than two hours the same work that used to take 10."

Carlos de León
Consulting Engineer
Diseño Ingeniería y
Técnica en Gas, S.A.
Mexico City

"I wrote a program which I use in designing overhead bridge cranes. It calculates the moment and the maximum deflection on the beams that carry the trolley. I plug in the section's modulus and moment of inertia. Then the bending stresses and deflection are calculated for me. I wrote another program that I use in designing column footings. A programmable gives me the capability to analyze several setups very rapidly and come up with a good solution."

Joel Waldbieser
Civil Engineer
Waldbieser Engineering
Terra Haute

"We had a program we ran twice a week on time shared computer. It involved entering stock prices, option exercise prices—60 option prices. We had chronic difficulty getting a clean, accurate run because wrong quotations crept in. We'd lose time locating each error. I got the idea we could do it faster with an SR-52 and a PC-

100 printer—screening each entry. I wrote the program myself. It worked beautifully. It's a big dollar savings. My secretary usually runs the program now."

Biddle W. Worthington, Jr.
Securities Account
Executive
Wertheim & Co., Inc.
New York City

TI's unique Algebraic Operating System makes the calculator part of the solution. Not part of the problem.

With the introduction of the SR-50 slide rule calculator a few years ago, Texas Instruments had a choice: algebraic entry or Reverse Polish Notation (RPN). TI chose algebraic entry because it's the most natural and easiest to use. Now, with the new programmable calculators, TI takes another major step forward in power and ease of use—the unique Algebraic Operating System.

AOS is more than just algebraic entry. It's a full algebraic hierarchy coupled with multiple levels of parentheses. This means more pending operations, as well as easy left-to-right entry of expressions—both numbers and functions.

Pending operations let you compute complex equations directly. For example, a seemingly simple calculation like this:

$$1 + 3 \times \left[4 + \frac{5}{\left(7 - \frac{2}{9} \right)} \right] = ?$$

contains six pending operations as it's written. A TI calculator with full AOS easily handles it just as it's stated, left-to-right. You don't have to rearrange the equation, or remember what's in the stack as with RPN.

Here's how AOS stacks up.

AOS remembers both numbers and operations, so you key-in your equation left-to-right. RPN only remembers numbers, you have to remember operations and the order.

Register No. In Stack	SR-52		SR-56		RPN Calculators
	Numbers	Oper.	Numbers	Oper.	Numbers
11	0				
10	0				
9	0				
8	0				
7	1	-	1	+	
6	3	× (3	× (
5	4	+	4	+	5
4	5	+	5	+	7
3	7	-	7	-	
2	2	+	2	+	2
1					

9 levels of parentheses
10 pending operations
11-register stack, including the display

9 levels of parentheses
7 pending operations
8-register stack, including the display

4-register stack include the display

A calculator with full AOS remembers both the numbers and functions in its register stack. And performs them according to algebraic hierarchy. As more operations become pending, the stack fills up (see diagram). Finally, when the equals key is pressed, the operations in the register stack are performed to give you the correct answer (15.21311475). Automatically.

Compare the SR-52 & SR-56 with other programmables in their class.

Operating characteristics	SR-56	SR-52	Calculating characteristics	SR-56	SR-52	Programming capability	SR-56	SR-52
Logic System	AOS	AOS	Log, ln, x	●	●	Program steps	100	224
Maximum number of pending operations	7	10	10 ^x , e ^x	●	●	Merged prefixes	●	●
Parentheses levels	9	9	X ² , √X	●	●	Program read/write on mag. cards	—	●
Memories	10	22	1/X, π	●	●	Data read/write on mag. cards	—	●*
Store & recall	●	●	Y ^x	●	●	User defined keys	—	10
Clear memory	●	●	√y	●	●	Possible labels	—	72
Sum/Subt to Memory	●	●	X!	●*	●	Absolute addressing	●	●
Mult/Div to Memory	●	●	Int X (integer part)	●	●*	Subroutine levels	4	2
Exchange display with memory	●	●	Fractional part	●	●*	Program flags	—	5
Additional special memories	1	38	Trig functions & Inverses	●	●	Decrement & skip on zero (loop)	●	●
Indirect memory addressing	—	●	Hyperbolic functions & Inverses	●*	●*	Conditional branching instructions	6	30
Exchange x with t	●	—	Deg/min/sec to decimal deg & inverse	●*	●	Unconditional branching	3	7
Fixed decimal option	●	●	Deg to Rad conversion & Inverse	●*	●	Indirect branching	—	●
Calculating digits	12	12	Polar to rectangular conversion	●	●	Editing: Step, Backstep	●	●
Angular mode Deg/Rad	●	●	& Inverse	●	●	Insert, delete	—	●
Grad angular mode	●	—	Mean, variance & standard deviation	●	●*	NOP	●	—
Digits displayed (mantissa + exponent)	10 + 2	10 + 2				Single step execution	●	●
						Pause	●	—

*Programmable functions

PC-100 printer. Turns an SR-52 or SR-56 into a quiet, high-speed printing calculator. \$295*

Imagine the convenience of getting a hard copy print-out of: Data. Intermediate results. Answers. Imagine the efficiency of listing an entire program at the push of a key. Or, printing the calculator's entire data memory contents with a simple program. And now imagine seeing every step of your program as it's executed—both the number and the function. Imagine no more. TI's exclusive PC-100 printer is here.

*U.S. suggested retail price, may vary elsewhere.

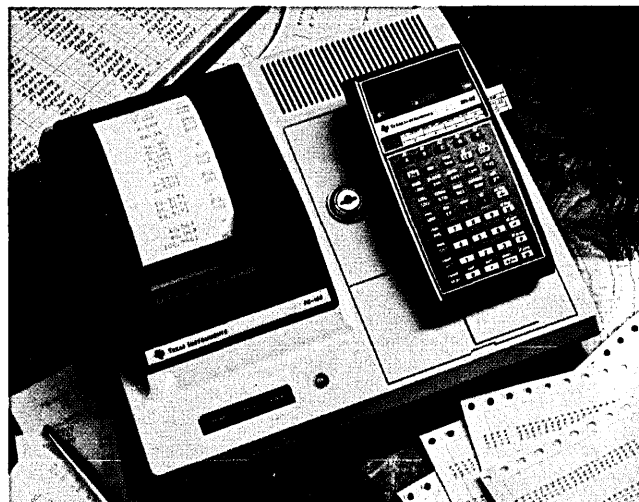

Be sure and send coupon to get your 16 page brochure and free preprogrammed magnetic card. Circle reader service number 200

TEXAS INSTRUMENTS
INCORPORATED

Printed in U.S.A.
65543

WESTERN EUROPE

with bickering over control, parallel design efforts, divided marketing efforts, and a constant battle with the unions over layoffs of unneeded personnel. There, the proof will be in the soufflé.

West Germany

After years of heavily subsidizing its medium- and large-scale computer efforts—in the form of grants to Siemens and the unsuccessful Telefunken Computer (now owned by Siemens as a renamed subsidiary) the German government has now turned its attention to small computers, terminals, and peripherals. In its third four-year program (1976-1979), it will give about \$625 million in matching R&D funds to its computer and data communications industry. Of the \$220 million earmarked for the manufacturing sector, some will go for further development in larger systems, but the better part is slated for small systems firms. These include Nixdorf, Philips GmbH, Triumph Werke, Kienzle, Anker Werks, and Matthias Hohner.

An expert on Germany was quick to point out to us that the program signifies recognition that it “doesn’t make too much sense to put greater emphasis on large systems” in view of IBM’s entrenched position (more than 60% of West Germany’s market). Distributed processing is more important, he noted. Germany also recognizes that “the edp market of today will have a big stake in the office of the future, a market that will be bigger than computing today. If Germany wants to have any chance, it must put its money in those areas. We are trying to make manufacturers aware of where the future is.”

He noted that Nixdorf and half a dozen other German manufacturers are already into computerized word processing systems. Facsimile systems, computerized PABX’s and “intelligent telephones” are among other German products. Further, many German firms with technological specialties are looking in the U.S. for small complementary partners.

Diebold Germany has tried to define the prospects of the computer market there. There are 11,400 minicomputers installed, 13,400 general purpose computers, and almost 80,000 of the small business and office computers. And all those 80,000 represent an enormous base for upgrading. (About half of those small systems are installed at large user sites too.)

The office systems suppliers are producing increasingly intelligent, applications-packaged by systems with communications ability; the mainframers

are offering smaller and smaller systems for this market; and the minicomputer manufacturers are moving into business applications. Thus, in Germany, there are some very big manufacturers fighting for that market. Nixdorf, Kienzle, Philips, and Olivetti all have thousands of the small business and visible record computers installed. DEC has 28% (in numbers) of the minicomputer market, so it is well established. Siemens also has larger dedicated minis, accounting for 36% of the market in value, 12% in number. Dietz, AEG Telefunken, General Automation, Data General, and Hewlett-Packard are all there too. And IBM, which is newly marketing the System/32 in Germany, is expected to have 1,000 systems installed by the end of 1976.

Diebold figures that, put in terms of price, the systems below \$100,000 will more than double in installation value between ’75 and ’80, from \$1.6 billion to \$4 billion. Those between \$100,000 and \$400,000 will do the same, going from \$1.8 billion to \$4.6 billion. Systems over the \$400,000 mark will move from \$6.4 to \$8.3 billion. The German government is putting its money where the biggest action is.

There are other major parts to the program, which include software, telecommunications, and microcircuitry. Germany has for some time been funding studies in various industries, such as manufacturing, to determine what needed software is lacking. Presumably more funds will go now into development of applications software.

Finally, some government monies will go into stimulating standards in communications and software, both nationally and in other countries. In view of the fact that standards committee members are usually from large vendors like IBM, who can afford the cost of participating, the government is considering establishing a fund to invite users with the knowledge but not the resources to sit on its committees. That’s possibly a darn good solution to a worldwide standards problem.

Finally, Germany’s small systems and peripherals companies are anxious to establish not only a strong national association but a strong affiliation with other national associations, like the Computer Industry Assn. Their intent is to be a pressure group to influence government policy on procurement, support, standards, and competitors like IBM.

Siemens A.G.

For being in the world’s third largest computer market, Siemens A.G. has had perhaps the most trying time of all mainframers. It was a licensee of RCA, building its products around the Spectra Series, just as Hitachi did. Then

RCA suddenly bolted the industry, giving Siemens not much more notice than it did its own employees. Two years later, it joined in the Unidata venture with CII and Philips—not without misgivings. Just as in the Japanese groupings, each company in Unidata developed some part of the Unidata line and began dividing up marketing responsibilities around Europe. Production had barely begun when CII’s owners decided that Honeywell Bull and its access to the American and other markets looked like a better deal for France than a “European Computer Cooperation.” Despite any standing legal agreements to the contrary, Unidata effectively collapsed last year.

There sat Siemens, with only part of a new line in its production. (It makes the full range now.) These events have been bitter pills for the German firm, especially since it has been absorbing losses year after year in computing—over \$150 million in 1974 and ’75 alone, despite government suborders. The firm’s data processing revenues run about \$400 million annually, with about 75% of that being in rental revenues. It has an installed base it values at \$2 billion, and its share of the German market, if not overwhelming, is a decent 17.5%.

Quantum Science Corp. lists Siemens as having 5.8% of the West European market, but most of that is West Germany; it does have 12% of the Benelux market and 6% in Denmark. Its international marketing effort seems minimal, especially in mainframes. Siemens sold off its South American base to Univac almost two years ago. Another report is that it plans to pull more and more peripheral development and production inside, although it has been buying from Control Data and Storage Technology for years. These are strange signs, especially when others are expanding and going into joint ventures for peripherals. Siemens is said not to be a candidate for the Computer Peripherals Inc. venture, now a CDC, NCR and ICL company.

Some read the signs as withdrawal symptoms. Others say that the firm is simply reorganizing and that its actual direction will come clear in the next year. It has stated that its goal is to become profitable by 1980. How this will be done is the question. Its new top executive for data systems is Dr. Anton Piesl, formerly chief of the communications division, and Siemens is very strong in communications, with a full line of gear ranging from terminals to PABX’s. Half its installations are on-line systems. It just received a \$46 million order from the Deutsche Bundespost (combined postal, rail and telephone agency) for a network comprised of data communications, concentrators, 960 data communications

WESTERN EUROPE

computers and 20 model 700 series systems.

Siemens is gaining strength in microcircuitry. It and Intel both have a licensing and oem arrangement for Intel's 16K RAM chip which Siemens will use in a line of boards containing up to 2 megabytes. It plans to market them in the U.S. by mid-'77.

In the meantime, it has a line of computers that only go to the 370/115 level at the low end and stop with the 755, about in the 370/148 range. Where it will get the larger systems from, internal production or outside source, is still unclear. It has been reported that Fujitsu and Amdahl want to strike a bargain with Siemens to market their large machines. Univac has publicly been courting Siemens, and is ready with a plan that shows how their lines would meld, with the 1100 Series at the top. So far Univac has been rebuffed.

Regardless of the reports, it is unlikely that Siemens would make any decisions on any proposals until at least this fall. The exact organization and reporting structure of data systems under Dr. Piesl is currently being decided. Sources expect that he will move very cautiously and offer a very conservative plan for Siemens' computer future. Siemens itself is a powerful entity with many activities, such as communications and components, in which computing and its technology are important. But as we've seen in the past with Philips, RCA, GE, Xerox, even this is no deterrent to getting out of the draining *general purpose* computer business. (Each of those firms still have computer-related products.) Regardless of what it does, Siemens surely won't enter any more joint ventures without agonizing soul-searching.

Other contenders

In addition to those heavyweight computer makers described above, Western Europe has dozens of other contenders, some of which are very large in other businesses if not in mainframe construction.

For example, Philips, Datsaab, and Olivetti are major European companies with international markets. Datsaab, now stripped of its major mainframe activities—which went into the Saab-Univac merger last year—is still a leading manufacturer of bank terminals with its D-5. About 30 Datsaab bank terminals have even been installed in the U.S. The company also has some interesting Alphascope displays which are plug compatible with IBM's 3270.

Olivetti, also best known for its terminals, has an intelligent line called the

A5 series plus floppy-disc office computers called the A6 and A7-80. It has bank terminals, word processing systems, and other specialized systems too.

Philips, among its many other activities, is also big in bank terminals.

Britain has a number of contenders in the field of real-time minis. These include Ferranti, GEC Computers, Digico, Leigh Data Systems (nee Arcturus), and Micro Computer Systems. Another company, Computer Technology Ltd., well known for its Modular One real-time minis, is presently shifting to the small business computer market; its CTL-8000 encompasses the entire IBM System/3 line. The company has offices in France, Belgium, and the Netherlands.

In Germany, office computers have been and are the central focus for the indigenous industry. Kienzle is a major supplier of office computers and floppy-based machines up to the System/32 level. It's about fourth in the market after Nixdorf, Philips, and Olivetti.

Another major German firm is Triumph-Adler, a subsidiary of Litton Industries. T-A has visible record computers and office computers to the floppy-disc level, plus intelligent terminals; one major order recently was 4,000 terminals for the German railways. Dietz makes the Model 621 real-time mini and model 600 small business computers up to the System/32 and System/3 Model 4 levels. AEG-Telefunken, whose mainframe activities were absorbed by Siemens after Nixdorf had a try at running them, is still in the computer business, mainly stressing turnkey or oem minis, its new Series 80. Krantz is strongest in printing and typesetting applications but also offers general-purpose office machines.

France has the strongest real-time mini industry in Europe. This is currently headed by SEMS, a new company spawned in the mergers that created CII-HB. SEMS has about 40% of the French mini market, and its products cross the entire DEC PDP-11 range. These include the CII Mitra Series and the Telematique Solar 16 series.

Intertechnique in France used to make Microdata computers under license, but the product line, the Multi-Series, is now developing French overtones. LogAbax, which markets actively all over Europe, concentrates on the visible record and floppy-disc office computer market up to the System/32 level. An intriguing French company is R2E, which is a little systems house that was first in the world to build minis around Intel microprocessor chips. Their computers are usually available about four months after the Intel chip comes out. Their line is called the Micral series, and is avail-

able in the U.S. through Warner & Swasey. Based on the Micral machines, R2E is now developing intelligent terminals, floppy-based office computers and other systems.

Scandinavia turns out to be one of the most advanced markets in the world, not in numbers but in sophisticated usage and advanced networks. Norway, Sweden, and Finland stretch a thousand miles into the Arctic, and networks have helped solve a number of commercial and social problems. Thus it is no surprise that firms like Denmark's Regnecentralen have advanced communications gear as well as medium scale computers of their own design. Regnecentralen also has exclusive rights to Datapoint and Data General equipment, though the latter arrangement is probably short-lived now that Data General's big Eclipse hits the its RC product line head-on.

One of the most interesting firms in Europe is Norway's Norsk Data Systems. Their product line stretches from the Nord 12, an entry level mini, through Nord 10 (analogous to the DEC PDP-11/45), and now up to the Nord 50, which might be termed a Super-mini or maxi-mini. One observer says: "It's like what the Cray-1 is to general purpose computing." With two processors, it reportedly has the processing power of an IBM 370/158, and costs about the same as a 370/115. However, like the Cray machine, it needs a separate system (a Nord 10) to run its I/O. Most users are Norwegian, but they have a contract at CERN in Switzerland to furnish a system for control of the 200-gv synchrotron—a very high status contract. CERN is said to be happy with the prototype machines, and shifting from DEC and HP to Norsk for other applications.

That's just the top layer

Those are the major players in Western Europe, but a glance at the large table (page 66) will tell some of the rest of the story. The computer industry is definitely an international one, and looking at only one segment—even one as large as Europe—gives a highly artificial perspective. Especially in terms of its participants, it's a complicated industry, one that's changing its profile about as rapidly as it's changing its technology. *

ACKNOWLEDGMENT *Information in this series was compiled from files in Datamation offices in Europe and the U.S. Special assistance was provided by Auerbach Publishers, Inc., and specific information was derived from Arthur D. Little, Inc., Sperry Rand, Quantum Science Corp., 21st Century Research, Japan Information Processing Development Center, Japan's Ministry of International Trade and Industry (MITI), and International Data Corp. publications.*

PROVEN

most compatible with your IBM Controller.
And System/3. And the 3790.



G77™ Display Terminal

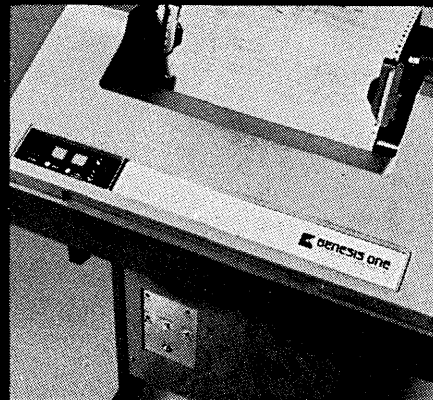

G-Series Printer

And Genesis One gives you extra features galore!

Our sensational, best-selling G77™ Display Terminal and G-Series Printers plug *directly* into the IBM 3271/3272 Model 2 Controllers, the System/3 and the 3790. And our units not only cost less than their IBM counterparts, they out-perform them. Thanks to all these most-wanted extra features: **G77 Terminal** Flicker-Free Display. Two LSI Memories.

Home Key. Repeat Key. Automatic Variable Initialization. Blinking Cursor. True Upper & Lower Case. Numeric Lock. Audible Alarm. Key Lock. 15-Key Numeric Pad. Light Pen. **G-Series Printers** — Super Speed (3 Models: 88, 120, 165 CPS.) Vertical Forms Control. Adjustable Forms Tractors. Audible Alarm. Automatic Motor Control.

Proven in use! Unbeatable price performance!

"I had never seen actual plug-to-plug compatibility before . . . we could pull the IBM unit out, put Genesis in without any interface, and get the same results for less money. Having tried Genesis out for a year, we are pleased with the quality and dependability of the equipment . . . and have not had a single failure."

**Bob Sisinni, Thermo-King
Minneapolis, Minn.**

"We have been using the G77 for over a year and have found the performance is equally as good as IBM's 3277. However, its price is far more attractive."

**Bill Taylor, Southland Life
Dallas, Texas**

"Moving away from IBM was a big step for us, but the G77 looked so promising we placed an order for 6 of them. They proved to be totally compatible and extremely reliable. We now have over 40 installed with 20 more on order, and we would recommend them to anyone."

**James Cranwill VP, Franklin Life
Springfield, Ill.**

For a demonstration on *your* IBM equipment — or for more information — send in the coupon. **Genesis One equipment sold and serviced in Canada, Western Europe and Australia by MAI International Corporation.**



GENESIS ONE an MAI company
COMPUTER CORPORATION

300 East 44th Street, New York, N.Y. 10017

D2-9

Send me your literature.

Phone me to set up a demonstration. (Phone No.) _____

Name _____

Title _____

Company _____

Address _____

City _____

State _____

Zip _____

WHAT DO ARRAY PROCESSORS AND

PATTERN RECOGNITION
SIGNAL PROCESSING
IMAGE PROCESSING
SEISMIC RESEARCH
SPEECH RESEARCH
SIMULATION

HAVE IN COMMON? **THE AP-120B**

FLOATING-POINT ARRAY PROCESSOR

“A PROVEN SYSTEM” with these **ABILITIES**

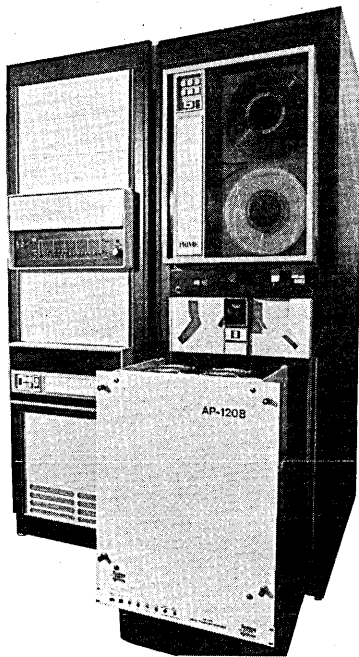

● REAL-TIME ABILITY

The power of 60,000,000 instructions per second, 167 nanosecond multiply/add, 2.7 millisecond 1024 FFT, etc. has made real-time processing a reality.

● PROGRAMMABILITY

Math Library of over 80 routines callable from FORTRAN simplifies programming. The Software Development Package with symbolic cross assembler, simulator and debug has allowed our customers to quickly implement additional custom routines using the AP-120B's powerful and straight-forward assembly language instruction set.

● FLEXIBILITY

A peripheral processor interfaced to your CPU and operating system with flexible format conversion to accept integer or floating point from your

host or other device. Parallel processing, with overlapped I/O, frees your CPU to do other things. Internal data memory from 8K to 1 Megaword.

● CREDIBILITY

Numerous application areas from oceanography to the Space Shuttle project have proven, with over a year's field history, the utility of the AP-120B hardware and software.

● AFFORDABILITY

What does it take to boost your mini to a mainframe? Less than \$40,000 for a complete system...that's a small fraction of what you would spend on a large mainframe of comparable power.

● AVAILABILITY

You bet! Delivery is 60-90 days A.R.O. for a ready-to-use AP-120B hardware and software system.

800-547-1885

CALL TOLL FREE

**floating
point
systems**
incorporated

0520 S.W. Cascade Blvd.
Portland, Oregon 97223
Phone (503) 620-1980
Telex: 360470 FLOATPOINT PTL

PLEASE SEND ME ADDITIONAL INFORMATION

Name _____ Title _____

Company _____ Phone _____

Address _____

City _____ Zip _____

My computer system is:

My application is:

CIRCLE 18 ON READER CARD

Computers from Communist Countries

by Bohdan O. Szuprowicz

The Soviet Union, East Germany, Poland, Bulgaria, Romania, Czechoslovakia, Hungary, and Cuba: the Comecon countries look to the outside world for technology and, eventually, for customers, but not as sources for computers. China is seen as more of a buyer, too.

The COMECON countries, which now account for about one third of the global industrial output, embarked during their 1971-1975 Five Year Plans upon a rapid expansion of their computer industries. Large numbers of new computer installations were planned, but relatively limited COMECON manufacturing capabilities in the early 1970s suggested the possibility of huge import markets for Western computer manufacturers.

Following the lead of ICL, which first penetrated the Soviet Bloc markets in the early '60s, most leading European and American manufacturers made intensive marketing efforts in that direction. Some achieved what appears to be significant sales while other spent equally significant amounts of time and money with relatively meager returns. Despite the much-heralded licensing opportunities and various joint venture propositions, the overall sales of Western computer and office equipment remain relatively modest and long-term profitability of some of the marketing programs is being questioned.

Much of the blame for relatively poor Western Supplier performance in COMECON markets is being placed at the doors of Export Controls in Washington and COCOM in Paris. But it now becomes apparent that persistent hard currency shortages, expansion of domestic production and above all a desire to capture a share of the rapidly growing computer markets in the capitalist and third world countries are probably much more significant factors limiting the Soviet Bloc countries in their purchases of Western equipment.

All this may be somewhat confusing in view of the fact that total East-West trade has been growing by leaps and bounds from \$7.3 billion in 1963 to about \$43.5 billion in 1974. But the West has been consistently selling more than buying in COMECON countries, many of which are running serious hard currency trade deficits. The Soviet Union alone was \$5 billion in the hole for 1975 and its total Western debt is estimated to be \$8 billion. Po-

land owes \$6 billion to the West and at least 20% of the proceeds of its exports to the West are absorbed by interest charges alone.

Therefore when it comes to buying Western goods and products, hard currency is allocated first to necessities of life and producer goods which can generate exports. The Soviet Union bought \$1 billion worth of U.S. grain in 1975 and Poland spent almost 50% of its total U.S. expenditure in 1974 on

East European nations provide only channels for transfer of Western technology to the Soviet Union.

grain foods and animal feeds. Next in import priority are industrial products and equipment required to exploit COMECON natural resources for exports. Imported computers in this scheme of things are regarded as industrial luxuries.

Inside trades

Some of the results of these circumstances become more apparent on examination of foreign trade statistics of COMECON countries. Exports of office equipment products, mostly computers, to the Soviet Union from major Western computer manufacturing countries are in most cases less than 1% of total office equipment exports from each Western country. By comparison, 60% of Czechoslovak office equipment exports go to the U.S.S.R., about 50% of German Democratic Republic exports, and at least 25% of all Hungarian shipments.

In fact, in 1973 exports in this category from all COMECON countries amounted to at least \$550 million. Much of this was intra-COMECON trade but a growing percentage are exports to the third world and some Western countries. The Soviet Union, German Democratic Republic and Czechoslovakia have already captured about 25% of the Indian dp imports market. COMECON computer manufacturers will probably make additional sales in other third world countries in the fu-

ture, particularly where Soviet and East European foreign aid extensions provide them with an additional marketing advantage, at the same time saving the recipient country from spending hard currencies.

During 1973, the last year for which complete COMECON statistics are available, twelve Western computer manufacturing countries including U.S.A. and Japan shipped about \$120 million worth of office equipment consisting mostly of computers and peripherals to the Soviet Bloc as a whole. During the same year within COMECON the German Democratic Republic alone shipped \$155 million worth of the same product category to the Soviet Union.

Also in 1973 little Czechoslovakia exported \$30.6 million worth of office equipment products to the Soviet Union. This is almost as much as the \$34.2 million of the same product category exported to the Soviet Union by the twelve Western computer manufacturing countries in that year. While Czechoslovakia also imported almost \$22 million worth of equipment from the West, it imported well over \$70 million from the German Democratic Republic, the Soviet Union, Poland, Romania and Hungary. All this leaves little doubt as to who really makes the big deals at those famous international trade fairs in COMECON.

The COMECON countries are jealously protecting their rapidly growing computer markets. They are also expanding their computer manufacturing capabilities jointly within the RIAD computer line and independently in each country. Cuba and Romania have now also thrown in their resources into the effort. The COMECON computer market is big enough to support several large equipment suppliers and names like Robotron, Zentronik, Mera-Elwro, Tesla, Videoton, Izot and Elorg already represent some of the largest electronic manufacturers in the world.

Soviet Union

Soviet Elektronorgtekhnik (Elorg), specializing in export and import of computers and electronic components,



**More accelerated achievement
DP courses
on
full-color videotape**

VSAM and access method services

Using AMS to create, maintain and work with VSAM data sets and catalogs... a brand new modular course for all computer personnel.

Applies to any OS/VS operating system. Includes exercises providing actual experience executing Access Method Services jobs on your own computer.

Covers Enhanced VSAM, alternate indexing and more... includes 7 videotapes, Student Guide, Coordinator Guide, Appendix and 4 audiotapes.

TSO the OS/VS time sharing option

An entirely new modular course on the application of TSO concepts in an OS/VS environment.

Includes creating and editing data sets, the manipulation of data and data sets, program execution and testing and command procedures.

Gives specific attention to commands such as LOGON, LOGOFF, EDIT, HELP, TEST, SAVE, LIST and RUN... includes 6 videotapes, Student Guide, Coordinator Guide and 6 audiotapes.

For more information

CALL 800/323-0377 TOLL FREE In Illinois and Canada, 312/323-0377 collect, or write:



Advanced Systems, Inc.
and its VAI subsidiaries

1601 Tonne Road
Elk Grove Village, IL 60007

Performance Through Knowledge

COMMUNIST COUNTRIES

has become one of the largest foreign trade organizations in the Soviet Union. Under the leadership of its president, Yuri Antonovich Kislenko, Elorg's turnover reached an estimated \$1 billion in 1975 in only five short years since its formation, placing it among the world's leading computer marketing organizations. Outside of COMECON, Elorg also sold Soviet computers in Belgium, Netherlands, Finland and India.

At the end of 1975 more than 400 Soviet computers were operating in foreign countries. Of these at least 100 were RIAD ES-1020 systems, 50 of which were exported to German Democratic Republic alone, which is believed to have previously imported as many as 10 of the large Soviet BESM-6 machines (which are roughly as powerful as an IBM 360/65).

Estimates from several sources put the total number of computers in the Soviet Union at about 15,000 in 1975 and forecasts for 1980 vary from 50,000 to 130,000 units. Many of those will be small business machines of the NAIRI-3 type or engineering and scientific computers such as the MIR-3 which sell for under \$100,000. But a recent study of major Soviet industrial end-users, identified several hundred enterprises in the Soviet Union which are operating or planning to install automated management systems including one or more large computers ranging in cost from \$300,000 to almost \$4,000,000.

At least 10 major computer manufacturing plants have been identified in the Soviet Union, four of which are already involved in production of RIAD processors. During 1971-1975 computer production increased 280% to a level of 2.2 billion rubles (about \$2.9 billion) per year. During the current 1976-1980 Five Year Plan, computer production is planned to increase by another 180%. Second generation equipment production is being phased out and replaced by RIAD, M-5000, K-200 and ISKRA series machines all of which are third generation.

On June 8, a Minsk radio broadcast in Byelorussian announced that the Ordzhonikidze Computer Equipment Plant began production of the RIAD ES-1060, which is the largest and fastest of all COMECON computers to date. Comparable to the IBM 360/75 in computing power, the R-60 appears 10 years after the venerable BESM-6 made its debut as the largest Soviet numbers cruncher. With speeds rated at about 1.5 million operations per second, the R-60 is almost twice as fast as the BESM-6 and will probably preempt for

the Soviet Union a considerable part of the large computer markets in all COMECON countries.

Also in development stages is the Soviet supercomputer known as the BESM-X which is being built at the U.S.S.R. Academy of Sciences and whose prototype is expected to be operating in 1977. The BESM-X is planned to operate at speeds as high as 15 million operations per second and the Soviet economy will probably need about 100 computers of this size in the foreseeable future.

Another important computer production program, which is under way only in the Soviet Union, is the ASVT-M series of modular control computers. It includes several third generation minicomputers such as M-4000, M-5000, M-40, M-4030, M-6000, M-400 and M-6010. These are used for process control applications in steel and chemical industries and many others. Several specialized application systems are already marketed in the West by Tech-maslexport of Moscow.

East Germany

The German Democratic Republic is the largest exporter of office equipment and computers among all COMECON countries. Its 1973 exports in this product category amounted to \$310 million, which is comparable to those of Italy and well above those of Sweden or The Netherlands. The Soviet Union, Czechoslovakia, and Poland are the major markets for German RIAD ES-1040 and the DARO products which include the Cellatron 8205 business computers of which at least 300 have already been installed in the Soviet Union alone.

VEB Kombinat Robotron is the best known computer manufacturer in the German Democratic Republic. It is responsible for the RIAD ES-1040 computer, considered to be the most successful of the RIAD series. Other models include the Robotron 300, the Robotron 21 similar in characteristics to the RIAD ES-1020, and the minicomputers of the Robotron 4000 series. In March Robotron announced a new third generation high speed computer which could be the development of the Soviet BESM-6 on which German Democratic Republic scientists have been working in recent years.

VEB Kombinat Zentronik, another "vendor," makes accounting and small business computers which are sold under the DARO label throughout the world. The Cellatron 8205 is the best known product but others include the DARO 1720 invoicing and accounting computers which have also been sold in West Germany, France, Spain and Australia.

Buromaschinen-Export of Berlin

markets computer products of the German Democratic Republic through the world. It provided Control Data with RIAD ES-1040 recently and is admittedly looking for further orders from the West. One RIAD ES-1040 was also shipped to India, and an order was received from Greece but it was later cancelled when the Greek government changed recently. Over 50% of all RIAD ES-1040 computers produced are now exported to COMECON countries but Buromaschinen-Export is also counting on its close relationships with several developing countries and hopes to sell ES-1040 computers in Africa and South America as well.

Cuba

The German Democratic Republic and Czechoslovakia have already supplied some office equipment products to Cuba, but so has France, the U.K., Italy, and Japan. But Cuba is now a member of COMECON and in October 1975 the Intergovernmental Commission on Computers met in Havana, where the Cuban Deputy Premier indicated that the country's medium-term plan is to develop the production of minicomputers, implement 40 control systems, and automate up to 75 sugar mills. Cuba already has an estimated 70 computers in operation.

Cuba is already manufacturing its own minicomputers, CID-201A, CID-201B and CID-202, at the Centro de Investigacion Digital of the Havana University. In the future Cuba may want to replace some of its older units such as its British Elliott 803 and French IRIS 50 with RIAD models. This may provide an opportunity and a jumping-off point to COMECON computer manufacturers for penetration of Latin American markets.

Poland

The Polish Association of Automation and Measuring Apparatus Industries, MERA, which manufactures computers and peripherals, is one of the largest industrial combines in Poland. MERA employs about 40,000 workers and at least seven major plants are involved in computer and peripherals production. Its total output in 1975 was estimated at almost \$3 billion of which at least 50% represented data processing equipment. MERA makes the RIAD ES-1030, has begun manufacture of the improved RIAD ES-1032, and apparently will also make the RIAD ES-1045 in the future. Production of the ICL 1900-based ODRA 1305s will probably phase out in a year or so and output of small business computers MERA 300 and 400 series will increase to several hundred units per year.

According to *Planned Economy*, published in Warsaw at the end of 1974, there were only 33 computers

Congratulations: you didn't have a computer fire again last year.

You're one of the lucky ones.

Unfortunately too many companies last year did suffer major business interruptions due to fires in or near their computer rooms.

What's even more unfortunate is the fact that a lot of the damage, clean-up and downtime could have been avoided.

Days of Downtime vs. a Few Seconds of Halon

These companies could have been protected by a high speed Fenwal Halon Fire Suppression System.

The system that snuffs out fires dry. Just seconds after they start.

And lets you get right back to work. No wet mess to clean up.

With some systems you've got to evacuate a room before the extinguishing agent can go to work.

But because Halon 1301 is harmless to people, it can start snuffing out the flames immediately. Which gives you the fastest jump on the fire.

With ordinary systems there's usually at least 48

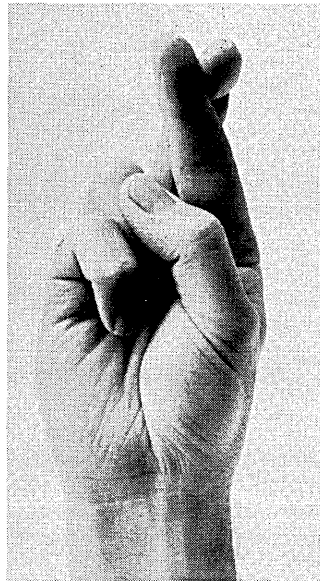

hours of clean-up before your computer can go back on line.

With a Fenwal system there's virtually no clean-up, no shorted-out wires. No electrical shock hazards. No damage to tapes or records.

Fenwal's unique, modular system permits rapid agent discharge and easy extension of existing systems.

Why Push Your Luck?

The consequences of a computer fire are a lot more devastating than you might think. Despite all the precautions you take.

At Fenwal we've got documented proof that our Halon Fire Suppression Systems are *the* solution to the damage and downtime of computer room fires.

It's proof you can see for yourself. In a film called "The Fireaters".

We think it will convince you that you need more than luck to keep your computer in business.

To arrange a viewing, call us at (617) 881-2000. Or write to Fenwal Incorporated, Ashland, MA 01721. A Division of Walter Kidde & Co., Inc. Our local, service-oriented distributors

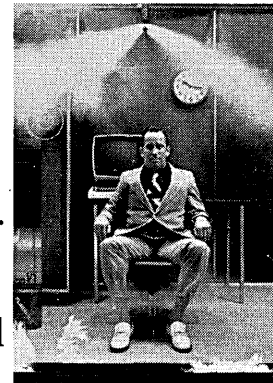

are listed in the yellow pages under "Fire Protection".

FENWAL

Nobody in the world has more experience in fire and explosion suppression systems.

FM Approved - UL Listed

COMMUNIST COUNTRIES

installed in Poland for every million inhabitants. The magazine indicated that during the current 1976-1980 Five Year Plan as many as 1,600 to 3,600 new computer installations should be made in Poland.

Metronex is the Polish foreign trade organization which trades in computers, automation equipment, and instruments; its turnover in 1973 was estimated at about \$300 million. Computers and peripherals have been exported to all COMECON countries regularly for many years, and some equipment was also shipped to Pakistan, North Korea, North Vietnam, Syria and Egypt. The Soviet Union is Poland's biggest market, but Poland set a target to export 250% more to capitalist countries in the future. Acquisition of licenses for products which satisfy local demand and can be sold in the West is of paramount importance to Polish foreign trade policy.

Poland entered into more licensing deals pertaining to computers and peripherals with Western manufacturers than any other COMECON country. The ideal type of licensing "cooperation" arrangement sought by COMECON countries is perhaps best illustrated by the MERA-LogAbax manufacturing agreement. Poland received a license to manufacture LogAbax D-180 high speed printers, which it may sell in COMECON and all other countries except France. But LogAbax agreed to purchase from MERA certain amounts of manufactured units and subassemblies during the first four years of the agreement, thereby guaranteeing an initial Western market for its own product made in Poland. In May 1975 the agreement was renewed to cover new version of LogAbax printers.

Other licensed production in Poland includes ICL printers, and ICL 1900 software was used to design the ODRA 1305 computers. Control Data provided a license to assemble and build CDC 9425 disc units in Poland under a three year agreement. LogAbax also sublicensed the Sycor Model 145 disc reorder in Poland, and Redifon of the U.K. licensed MERA to manufacture the Seecheck key-to-disc systems which are based on an original Entrex design from the U.S. More recently, CII-HB of France held discussions about licensed production of IRIS 80 computers in Poland, and earlier CII agreed to assist in modernizing Polish computer factories both in Wroclaw where the ODRA and RIAD computers are made and in Warsaw where the MOMIK-b minicomputer, and LogAbax- and ICL-licensed printers are manufactured. Staansaab of Sweden is also reported

to have licensed MERA to build an intelligent crt terminal.

Despite these arrangements and presumed export benefits to Poland, the Mera-Elwro computer manufacturing enterprise in Wroclaw announced a competition among electronic component manufacturers of Poland early in 1976 offering prizes for domestic designs of electronic subassemblies which would replace hard currency imports as soon as possible.

Freedom to export to the Soviet Union and other COMECON countries may have also played a big part in Poland's recent decision to sign a licensing agreement with ASEA of Sweden for the manufacture of numerical control computers. At present several regional numerical control service centers based on Minsk-32 computers prepare programs for Soviet users of numerically controlled machine tools. Recent estimates suggest that Soviet production of numerically controlled machine tools is being increased from an estimated 7,000 per year at present to 35,000 units per year in the near future, which will present a significant market for numerical control computers which Poland may want to exploit, while at the same time taking care of its own needs for nc computers.

The ability to export high value-added products to the Soviet Union is vital to all COMECON countries except Romania because they depend almost entirely on Soviet petroleum and natural gas imports for much of their production, fuel for transport, and petrochemical feedstocks.

Bulgaria

Bulgaria is another COMECON country which started its computer industry by assembly of Fujitsu FACOM 230-30 computers, and there are suggestions that this experience contributed significantly to the joint design with the Soviet Union of the RIAD ES-1020 computer. Today the R-20 is being sold in all COMECON countries and some units have been shipped to other countries. An improved version known as the RIAD ES-1020B has also been introduced.

A large percentage of Bulgaria's computer installations was made up of Western imports only a few years ago, but its present 124 computer centers are equipped predominantly with domestic RIAD ES-1020s or Soviet ASVT-M computers for process control applications.

Izot, the Bulgarian computer manufacturing organization, builds the Izot 310 minicomputers. These are available with U.S. WANGCO tape and disc drives, and the licensing agreements also allow these units to be manufactured in Bulgaria. Other peripherals made in Bulgaria include the 7 and 29

megabyte disc drives; these are also marketed throughout the COMECON and Western Europe by Izotimpex, the foreign trade organization specializing in electronic products.

Romania

Romania did not join the RIAD program during the 1971-1976 period but developed its independent computer industry based on licensed production of the French CII IRIS 50, known as FELIX C-256 in Romania. It also formed a joint venture with Control Data known as RomControl-Data which manufactures CDC card readers, punches and printers under license. Recently, however, Romania joined the RIAD program and in March announced a new computer known as FELIX C-512/1024 with speeds claimed in the order of 300,000 operations per second. A new Romanian minicomputer designated the FELIX C-32 has also been announced by the Enterprise for Electronic Computers.

Romania exported a total of \$24 million of office equipment products in 1973, mostly to Poland and Czechoslovakia but also to West Germany, France and Japan.

In August 1974, Romania held a specialized electronic computers and telecommunications exhibition in the People's Republic of China. Romania is the least important of the COMECON computer manufacturing countries and it is also the smallest market, but its long standing trade relationship with People's Republic of China give it a potential market which is large enough to make the development of an independent computer manufacturing capability worthwhile.

Romania is also the recipient of significant Chinese foreign aid for industrial development, estimated to be in the order of at least \$250 million in recent years. This puts Romania in a position where it should develop products with which these extensions can be repaid in the future, and computers which include Western technology as well as peripherals could well fill that role.

It was estimated that at end of 1975 there were a total of 70 computers installed in Romania, plus some process control machines. But all Romanian installations are third generation computers, and regional computer centers serve about 600 Romanian enterprises. Future plans include expansion of the computer centers to about 40 and development of a national network.

Romania and Poland are the only two COMECON countries which have been granted the Most Favored Nation (MFN) status in trade with the U.S.A.

Like Poland, Romania also entered into numerous licensing agreements



modular one

HAS WHAT IT TAKES FOR END-USERS!

"TTY-COMPATIBILITY!"

Single-unit price starts at
\$1,650
Quantity discounts available.



"EDITING!"

Single-unit price starts at
\$2,050
Quantity discounts available.



"POLLING!"

Single-unit price starts at
\$2,500
Quantity discounts available.



You told us what you want in a video terminal. So we designed and built one that has it. We call it Modular One.

You want high-performance TTY-compatibility. Modular One has it!

With standard features including:
 1,920-character display (80x24) on a 12-inch bonded screen. Incremental and absolute cursor positioning. Dual video intensity. 11-key numeric pad. Movable keyboard. Choice of 8 transmission rates up to 9,600 baud. Communication interfaces EIA RA-232 and current loop. Choice of block or blinking underscore cursor. Choice of white-on-black or black-on-white display presentation.

You want an Editing Option. Modular One has it!

With a unique field attribute command character which allows the host computer to assign as many as 11 conditions to specific screen locations. 8 different video representations. 8 special function keys. Data compression and record separation. Tabulating advance, back set, clear and automatic. Automatic repeat function for period, space and hyphen. Insert and delete line. Insert and delete character.

You want a Polling Option. Modular One has it!

It provides protocol compatibility for interfacing to the communication networks of most computer manufacturers. Protocol may be user-defined.

You want a selection of options for specific applications. Modular One has it!

Upper/lower case. Parallel output connector. Auxiliary serial output connector. 202 compatibility. Synchronous interface. Modem cable. Power on/off security key lock. Contact your Hazeltine representative for a complete listing.

You want human engineering features that give your operators comfort (with speed and accuracy). Modular One has it!

Clear, sharp 7x9 dot matrix display. Elevated non-glare screen for comfortable viewing. Stair-stepped keyboard. Non-glare key caps. Movable keyboard.

You want economy and value, combined with high-performance and reliability. Modular One has it!

Modular One establishes new standards of reliability and value, incorporating the latest in high-reliability design techniques and components... the kind you expect in any product bearing the Hazeltine name.

Yes, now with Modular One, Hazeltine makes it easy for you to have precisely the terminal you want, at the right price! Phone your nearest Hazeltine representative today for a demonstration and price quotation.



Fast becoming the new "Standard in its Class."

Hazeltine Corporation, Computer Terminal Equipment, Greenlawn, N.Y. 11740 (516) 549-8800 Telex 96-1435
East: N.Y. (212) 586-1970 Conn. (203) 875-6429 Boston (617) 429-4009 Phila. (215) 676-4348 Wash., D.C. (703) 979-5500 Rochester (716) 254-2479 Midwest, Chicago (312) 986-1414 Columbus (614) 864-4714 Detroit (313) 559-8223
South: Atlanta (404) 434-8444 Houston (713) 783-1760 Orlando (305) 828-0132 West: San Mateo (S.F.) (415) 574-4800 L.A. (213) 553-1811 Denver (303) 770-6330 Seattle (206) 242-0505. Canada: MISCOC Data Communications Equipment Services, Ltd.
 Toronto (416) 678-7354 Montreal (514) 631-4381 Vancouver, B.C. (604) 731-0714 Calgary (403) 264-8237. England: Hazeltine Ltd. 01-948-3111 Telex (8511) 928572. Germany: Hazeltine GmbH 0611-590748 Telex (841)-416924.
FOR WORLDWIDE SALES INFORMATION CALL: (516) 549-8800.

COMMUNIST COUNTRIES

with Western electronic manufacturers. Besides the CII and CDC deals, Romania signed licensing agreements with Thomson CSF of France for manufacture of TTL circuits, with Bunker Ramo's German subsidiary for production of connectors, with Singer for calculators and Foxboro for certain process control instruments. Memorex and Ampex signed OEM contracts to supply disc and tape drives for the FELIX computers. Corning Glass formed a joint venture for the manufacture of TV tubes and ITT signed a technical cooperation agreement.

Czechoslovakia

Czechoslovakia is another major data processing equipment manufacturer; in 1973 it exported a total of \$53.2 million of office equipment products to COMECON and other countries. The Soviet Union and Poland are major markets for Czechoslovak equipment, but Cuba and India are also importing some products and lesser sales have been made in Yugoslavia, Spain, Greece, Switzerland, West Germany, North Vietnam, Pakistan, North Korea, Ethiopia, Australia and even the U.S.

During the 1971-1975 period, at least 115 RIAD computers have been put into operation in Czechoslovakia and the current 1976-1980 Five Year Plan calls for additional 750 computers, 80% of which will be RIAD machines. Some Western imports continue and Univac recently signed an agreement to supply about \$14 million worth of 90/30 computers, which may mean up to about 40 units, but each individual installation will require export controls approval. Western market share here has dropped significantly during the last few years, too. Sources in Czechoslovakia often stated that relatively large Western equipment imports during the '60s were a stopgap measure designed to computerize vital sectors of the economy while adequate domestic production was being developed.

In 1974 the country had a total of 486 general purpose computers, 341 minicomputers and 240 ARITMA punched card processors, for a total of 1,067 computers.

Czechoslovak Tesla is one of the largest electronic manufacturing combines in the world. It employs a total of 75,000 workers and consists of 29 independent enterprises which operate 50 various plants producing components, semiconductors, integrated circuits, computers, television and other electronic consumer products. Tesla built the Model 200 computer under a

license from BULL-GE which expired in 1975. In July 1975 a new integrated circuit computer was announced, designated Tesla 201 and claimed to have a 126,000 bps data transfer rate. The firm makes tape drives, process control computers, core, displays, and data transmission gear as well as the RPP 16 and RPP 16M process control computers; and it uses Memorex 630 disc drives and controllers on an OEM basis.

The ZPA combine in Prague employs 35,000 and consists of 16 enterprises operating 24 plants and two research institutes. The RIAD ES-1021 computers are made by ZPA, and the new RIAD ES-1025 is expected to be in production in 1977-1978. The Aritma enterprise, which includes five plants specializing in unit record and data preparation equipment and peripherals for the RIAD program, is part of the combine.

KOVO is the foreign trade organization which handles import and export of office equipment, computers, and precision engineering products. Besides Tesla, Aritma, and RIAD products, KOVO also exports typewriters, paper tape I/O devices, and other peripherals manufactured in Czechoslovakia.

Hungary

Hungary is the manufacturer of the smallest RIAD computers, the ES-1010 which was developed from a French license for the CII MITRA 15 minicomputer. This followed an earlier CII license for production of the 10010 by the EMG electronic plant in Hungary. New versions of the RIAD minicomputers being developed in Hungary are designated as ES-1005 and ES-1008.

There are several enterprises in Hungary engaged in the manufacture of minicomputers, peripherals, CRT displays and data communications equipment. By contrast with other COMECON countries, many manufacturing enterprises in the country are authorized to operate their own foreign trade organizations. In addition there is a central foreign trade organization Metrimpex which also handles imports of foreign computers and peripherals for specific end users.

Videoton RT is the best known Hungarian electronics manufacturer. It is engaged in computer manufacture and produces the RIAD ES-1010 mini. The enterprise was also licensed by Data-products in 1973 to manufacture the 2310 and 2410 line printers. Other important firms include MTA-KFKI, an institute of the Hungarian Academy of Sciences which designed and manufactures the TPA 70/25 and the TPA 70/40 minicomputers (comparable to the DEC PDP-11). Orion-Radio is another electronics enterprise which makes alphanumeric displays and the GD-71 graphic display purchased by Control Data for its RIAD ES-1040 installation

in Washington. The Hungarian Optical Works-MOM enterprise produces a series of paper tape I/O devices, a small fixed head disc, and TRT-Orion plant makes several modems, multiplexers, and terminals which are all RIAD compatible.

A total of \$25.2 million worth of data processing and office equipment was exported by Hungary in 1973, mainly to the Soviet Union and German Democratic Republic. During 1976 the U.S.S.R. agreed to export to Hungary several RIAD models such as ES-1020, ES-1030 and ES-1050 valued at about \$18 million. Hungary in return agreed to export to the Soviet Union ES-1010 minicomputers and displays valued at about \$25 million.

At least two RIAD ES-1040s are believed already in operation in Hungary. They are the largest computers in the country succeeding the ICL System 4 and Siemens 4004 systems there.

The COMECON countries are clearly developing their computer industry rapidly, and as soon as the RIAD systems begin to provide adequate hardware for domestic industries and applications software is available, they will make a strong effort to capture foreign markets. The Soviet Union, German Democratic Republic, Poland and Czechoslovakia are already firmly established as suppliers of varied electronic products to many countries throughout the world and will add other computers and peripherals to their product lines as soon as competitive products are developed or special sales opportunities arise.

Most likely outside markets for COMECON computers are third world countries which have been granted various forms of foreign aid by the Soviet Union and the East European countries. Among those recipients, India is probably the largest, having been granted during the last 20 years a total of \$2 billion by the Soviet Union and about \$500 million by the other East European countries. Syria, Iraq, Bangladesh, Pakistan and Guinea are other major recipients. A special recent case is Argentina, which was granted \$200 million in economic aid by the Soviet Union and another \$220 million by Eastern European countries in 1974.

China

The People's Republic of China so far has not become a market for COMECON computers or electronics, having developed into a major electronics manufacturer itself with an estimated total production in the order of \$2 billion. A total of 20 different computer models have been built in China since 1958, with third generation integrated circuit machines first appearing about 1970.

COMMUNIST COUNTRIES

The largest Chinese computers are 48-bit word machines claimed to have speeds in the order of 1 million operations per second, such as the DJS-11. Probably more numerous as workhorses for scientific and engineering computation are the 24-bit DJS-17 computers operating at 100,000 operations per second and the 48-bit DJS-18 at 150,000 operations per second. The latest Chinese computer, announced in 1975, is claimed to operate at 500,000 operations per second and is designated the DJS-130.

In December 1975 a Japanese electronics industry mission in China reported that LSI circuits with a capacity of 10,000 transistor elements were being manufactured in a Peking semiconductor factory. Japanese executives doubted whether these were mass produced as yet and they rated a large Chinese computer with domestic integrated circuits as two to three times slower in arithmetic speed than the latest Japanese computers.

Chinese National Machinery Import and Export Corporation, which handles trade in computers, electronics and other industrial equipment, is one of the largest trading corporations in the world. Chinese industrial development is proceeding at a fast rate and the electronics industry has developed to a point where China is the third largest radio manufacturer in the world. Economies of scale offered by the domestic market may provide incentives to engage in exports of instruments and other electronic equipment, particularly to third world countries. Albania is already believed to use Chinese computers, and in November 1974 Radio Tirana announced that the first Albanian-assembled computer was completed.

They make the rules

Increasingly COMECON computer trading organizations are showing up at Western exhibitions. Soviet Elektronorgtekhnik was at Intercon-74 in New York and at Intercon-Elektro-76 in Boston. Robotron exhibited its 4201 minicomputer at the Hannover Trade Fair this May. Hungarian Videoton and Bulgaria's Izotimpex were also there with disc drives and minicomputers. Poland's MERA was selling the MERA 305 office minicomputer with the licensed CDC disc drive and Log-Abax DZM-180 printer. Any of those enterprises can sell their products anywhere in the world, but they hold monopolistic control of their own markets.

In Finland, Belgium and Netherlands, Soviet Elorg is participating with

local business interests in operation of computer service bureaus using Soviet RIAD ES-1020 computers, and plans to bring in ES-1050 machines in the future. The long term objective of these enterprises is reportedly not to test various Western peripherals for use with RIAD computers but to develop Western markets for Soviet hardware.

COMECON computer technology remains several years behind that of the West but some of its manufacturing and marketing organizations are among the largest in the world. Various observers believe that most East European nations only provide channels for transfer of Western technology to the Soviet Union to which stricter export controls are applied. Current export controls by end user approval are believed ineffective anyway because most end-users are state owned corporations and their resources may be requisitioned for government use at any moment, leaving a Western supplier without any recourse whatsoever.

The rapidly growing COMECON computer industry is now at a stage where it is fast coming up against a serious software barrier. It also now experiences a lack of trained personnel reminiscent of the '60s in the U.S. Many invitations to bid on large sophisticated systems such as the Kama River Truck Plant, the Aeroflot and Intourist Reservation Systems, the Air Traffic Control Systems, and the Airport Logistics Systems in the U.S.S.R. are now regarded by some as means to exploit the systems and planning know-how of top Western suppliers.

COMECON "anti-import committees" often unidentified yet operating in every country, take even longer to approve Western imports than export controls to approve export licenses. Many final contracts awarded are usually much smaller than the initial purchase requirements would suggest. Disenchantment, bureaucratic frustration, expensive promotion and meager or nonexistent returns led some smaller firms to disband their painstakingly assembled Soviet Bloc marketing groups and adopt a "wait and respond if asked" attitude.

Increasing production of the improved RIAD computers, expected continuing shortages of hard currencies for the foreseeable future, and monopolistic control of COMECON markets are bound to result in ever diminishing market shares for Western suppliers regardless of export controls. Also, some firms simply cannot afford to get involved in unwanted semi-barter deals or take payment in form of donkeys or strawberries and act as marketing organizations for COMECON trading companies.

The much touted follow-on COMECON markets develop primarily for

domestic suppliers. Much of the IBM 360 compatible equipment which is only now being manufactured and installed by COMECON countries has been available in the West for years, and large quantities could have been shipped to COMECON users with very little objection from export controls. Large quantities of such computers and peripherals have even been offered in COMECON at extremely attractive prices and some trading firms were willing to set up triangle or barter deals but were mostly rebuffed.

Analysis of export statistics are probably more indicative of the real story. Most Western computer manufacturing countries ship only a very small percentage of their total computer and office equipment exports to COMECON in any given year. In fact, average annual exports from each Western country of such products are consistently so small that it is even difficult to substantiate the argument that stricter export controls in one Western country create a long-term advantage for another.

Withholding the most advanced computer technology from COMECON manufacturers is in fact also protecting many existing Western markets, aside from its strategic objective. Some of the third world computer markets will be threatened by the COMECON suppliers as soon as they develop competitive hardware and software, and sufficient hardware production. Yet these exclusively Western markets are probably already larger than what the Western market shares in COMECON would ever be allowed to become even in total absence of any export controls. That COMECON scramble may simply be not worth the switch. *



Mr. Szuprowicz is president of 21st Century Research, an international market research organization. His firm has recently completed related studies of the countries mentioned in this article. Previously a vice president and research director of High Technology West, a Los Angeles investment research firm, Mr. Szuprowicz has also held management, marketing, and engineering positions at IBM, CEIR-Control Data, Computer Usage Corp., Boeing, Canadair, Convair and others.

Can a Security System improve your whole operations picture?

Now it can.

Because Rusco's new CARDENTRY System 500 handles a lot more than security.

CARDENTRY is a sophisticated new access control system based on Rusco's patented cryptically encoded ID card that's virtually impossible to decipher or duplicate. So it's already miles ahead of locks and keys.

But CARDENTRY has a brain. With enough memory to handle up to 20,000 ID cards

and then some. So in its spare time, it can do things like control and record all copy machine use. Monitor alarm, fire, smoke detectors (or just about anything else) and warn you when something's amiss. Keep unauthorized cars out of your parking lot. Immediately tell you who's in your plant and who's out. Collect data to automatically generate payroll. Lock and unlock doors or equipment at preset times.

programmable. So a lost card can be ruled out forever at the touch of a button. No lock changing. No panic. And if you've got an unusual application, the only customizing that has to be done is in the software.

Let Rusco show you how CARDENTRY can improve your operations picture. It's surprisingly easy to buy or lease, and it's supported by a nationwide network of factory-owned sales and service offices. Write or call:

CARDENTRY is



CIRCLE 102 ON READER CARD

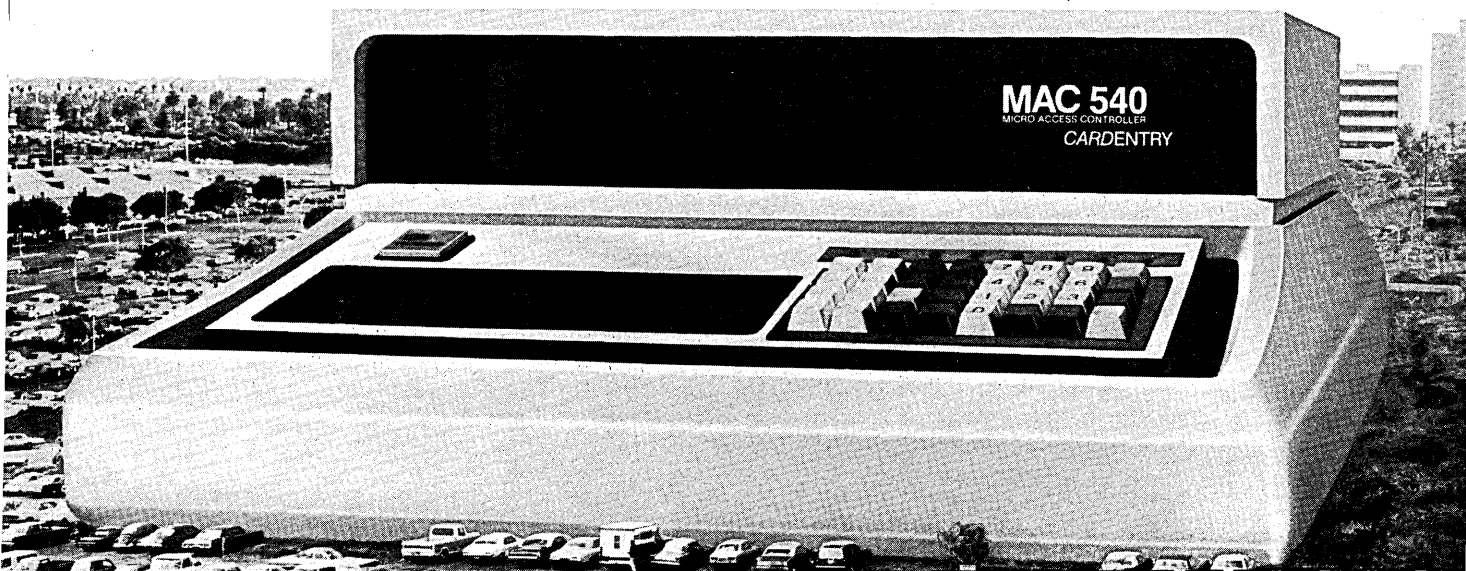

Yes I'm interested in what CARDENTRY can do for my operations picture. Have salesman contact me.

- Send details and address of my local Rusco sales office.
- Include information about Rusco's credit card manufacturing capability.

Send To: Rusco Electronic Systems
P.O. Box 5005
1840 Victory Blvd.
Glendale, CA 91201
Phone: (800) 423-2557
in Calif: (213) 240-2540

RUSCO
ELECTRONIC SYSTEMS

NAME _____

COMPANY _____

ADDRESS _____

CITY _____ STATE _____ ZIP _____

Rusco Electronic Systems a division of Rusco Industries, an AMEX company an Equal Opportunity Employer

DM9

Introducing IBM Word Processor/32:

**The power and
capacity of a computer.**

**The simplicity of
an IBM magnetic card.**

Going on the basic premise that the more productive word processing is, the more valuable it will be to you, we offer Word Processor/32. A word processing program used with an enhanced IBM System/32. A desk-sized computer designed for easy operation.

It gives your office large storage capacity, computer logic, text editing and formatting capability, speed, and versatility.

And these advantages can all be realized through an IBM magnetic card.

Its speed and ease of operation will be especially valuable to you in the area of editing and formatting text.

Revision

Through simple keyboard instructions you can:

1. Add, change or delete information with a significant reduction in media handling.
2. Find and change every occurrence of a word or phrase throughout a document no matter how long it is.
3. Revise IBM magnetic cards for playout on the IBM Mag Card, the IBM Mag Card/A, and the IBM Mag Card II typewriters.

Formatting

Formatting of text can be achieved simply and without constant retyping since the computer automatically adjusts copy to whatever format you choose. Moreover, Word Processor/32 allows you to:

1. Modify the layout of a letter or multi-page document simply and speedily.
2. Insert headers and footers on every page by typing them just once.
3. Automatically renumber pages, footnotes or paragraphs whenever copy is either added or deleted.
4. Automatically align columns of figures.

Automatic Document Generation

Among its important features, IBM Word Processor/32 can assemble documents automatically from previously stored sentences, paragraphs or pages, with automatic insertion of variable data. It can also compile and print letters

conditionally—one letter to customers, another to prospects, etc. And it can even personalize form letters used in mass mailings.

Administrative Support

This system also reduces the time spent on the tedious tasks of maintaining and updating lists and files. With its vast storage capacity, it can store and update constantly changing information, like customer names and addresses. And it can sort and print this information into just about any sequence you wish.

In addition, Word Processor/32 can log all of your correspondence—allowing you to keep an up-to-date record of your work flow.

Productivity Gains

Through the magnetic card, Word Processor/32 also extends all the above advantages to your existing IBM mag card typewriters.

Word Processor/32 not only helps you improve turn-around time by printing error-free final copies at computer speed...unattended... but can also help reduce the cost of your document processing.

Data Processing Applications

The IBM System/32 is also available for an entire spectrum of data processing applications...such as billing, accounts receivable, sales analysis, payroll, inventory, etc.

Learn more about Word Processor/32's ability to offer increased productivity and better management control. Just call your IBM Office Products Division Representative.

IBM[®]
Office Products Division

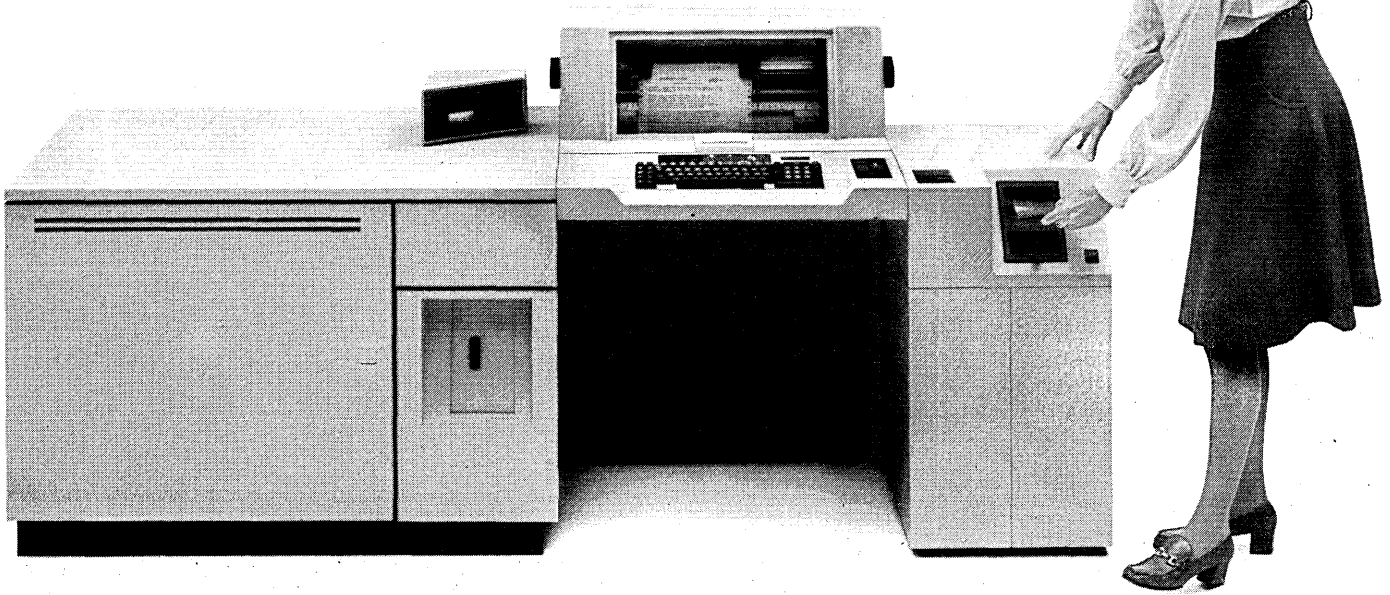

IBM 370 users: An Intel add-on memory system can save you up to 50%.

IBM means computers. Intel means semiconductor memories. And because we're the largest independent manufacturer of semiconductor memories and provide our own service we can offer you substantial savings compared to the IBM alternative. An Intel system will also help you prolong the life of your System 370 because we'll give you up to two times the memory capacity you can get from IBM, and in the original frame. That means you don't have to "trade up" your entire computer system just because you're running out of memory capacity.

You can add to or replace the IBM supplied memory. Either way you'll save up to 50%. As an example, you can get 4.0 megabytes of Intel 370/158 memory for less than you'd pay for 2.0 megabytes of IBM. That's like getting 2.0 megabytes free and with money left over. Money to use in other ways. We can expand your 370/135 to one megabyte in a single frame, or your 370/158 to 8 megabytes in a single frame. In either case that's twice the capacity offered by IBM.

If you've gone to the world's largest computer company for your computer, doesn't it make sense to go to the world's largest semiconductor memory company

for your add-on memory? Intel add-on memory systems for the IBM 370/135, 370/145, 370/158, and soon the 370/168, will enable you to add more memory, in less space and at lower cost than the IBM alternative. Start saving now. Join the over 300 IBM 370 users who have

already made the switch. The coupon will get you information. A phone call to any of our sales offices will get you one of our systems specialists.

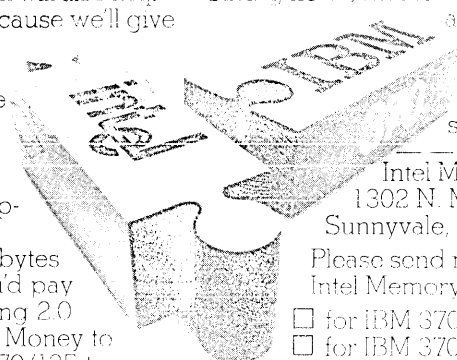

Intel Memory Systems
1302 N. Mathilda Avenue
Sunnyvale, California 94086

Please send me information on the following Intel Memory Systems

- | | |
|--|--|
| <input type="checkbox"/> for IBM 370/135 | <input type="checkbox"/> for IBM 370/158 |
| <input type="checkbox"/> for IBM 370/145 | <input type="checkbox"/> for IBM 370/168 |
| <input type="checkbox"/> for _____ | |

Name Title _____
Company _____ Mail Station _____
Address _____ Phone No _____
City/State/Zip _____

intel memory systems

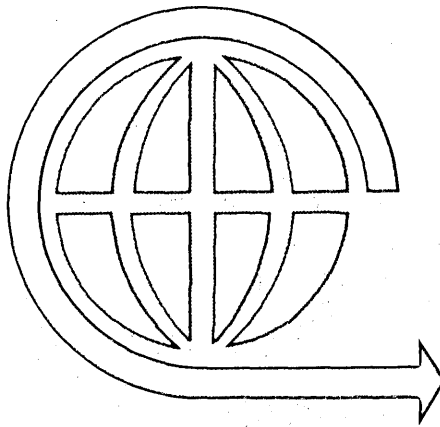

Japan's Computer Industry

by Edward K. Yasaki, Far East Editor
and Angeline Pantages, International Editor

With government help, internal combines, and external joint ventures or licenses, the nation is engaged in a giant game of catching up to the U.S.

Japan has long backed ambitious policies encouraging both the use and production of computer systems. Since the 1960's, it has subsidized the development of numerous computers and computer lines. The most recent accomplishments were the product lines of the three mainframer groups put together in 1972: Nippon Electric (NEC) and Toshiba have produced the ACOS Series 77; Mitsubishi Electric and Oki Electric combined for the COSMO series; and Fujitsu and Hitachi joined for the M series and upcoming V series of computers.

Early on, the Japanese government fostered the creation of a very important entity for all these mainframers—Japan Electronic Computer Corp. JECC is the leasing company that removes the rental burden from the shoulders of the Japanese computer manufacturer. The existence of a predominantly rental-oriented industry—an IBM innovation—has previously bludgeoned many a cash-poor company.

More exciting projects are in the works. The projects to develop a pattern recognition system and ultra large-scale integrated circuitry have been much publicized. Also, last year a definite schedule and funding were set for the design and production of a new computer line that is supposed to counter IBM's "future systems," (the

Japanese view of FS, in any case.)

The period of development for the new line is 1976-1983. Five manufacturers from the groupings above (all but Oki) will invest \$833 million, while the government will invest \$150 million. Included in that are the ultra-LSI project, plus architecture, hardware, and software development.

Another very recent announcement is a plan by the Ministry of International Trade and Industry (MITI) to promote exports to the developing nations. The emphasis on export both to these and to developed nations is naturally timed to coincide with Japan's "liberalization" of the computer industry. Liberalization has eased import restrictions and allowed foreign firms to own 100% of a Japan-based company. With increasing competition from foreign firms, particularly in services, smaller systems, and peripherals, Japan is trying to move its own companies outward.

Hence, MITI will set up an "Overseas Data-Information Cooperation Association," composed of computer, peripherals, and software vendors. This group will: provide training through the Japan International Cooperation Agency; assist in formulation of projects; and help coordinate "commercial dealings" in large projects. The government will back it with preferential loan measures.

Exporting computers, unlike exporting automobiles, has been a problem for the country. Current exports amount to only 3.4% of Japanese computer sales. With this "overseas" program and others, the goal is to raise that to 16% by 1985.

The programs outlined sound right to the point—combining research, production, marketing, leasing, and export efforts provides economies of scale no single company in Japan could ever attain. The following commentary describes some progress to date.

Technological progress

The development of a 64K-bit semiconductor memory chip has been announced by Fujitsu Ltd. Although it's not yet a commercially available product, it comes at a time when the most advanced memory developers in the world are starting to produce the 16K-bit chip in quantity. This announcement by the company is certainly no indication that the Japanese are ahead of everyone else in digital semiconductor technology. But it shows the new stress being placed by them, as they play catch-up to the Americans, as well as the strides they've made along the way.

To this day, the Japanese computer industry is behind the U.S. in hardware technology and software development,

3 years, 12 patents, and 30,000 installations back every Shugart floppy disk.

No wonder two out of three OEM's specify Shugart floppy disks. They get more exclusive features, more product support, and more responsive delivery schedules. So can you.

A SA800/801 diskette storage drive gives your system more salable features:

- Single density, or double density for the same price.
- A patented diskette clamping/registration design that prevents diskette damage from misregistration over 30,000 interchanges.
- A proprietary ceramic read/write head that extends media life to over 3.5 million passes per track with a head life exceeding 15,000 hours.
- Extras like patented pop-out diskette retrieval, drive activity indicator light, and die cast cartridge guide and base plate.

If your system needs more data storage, you can easily convert from single to double density on the same drive. And you have a wide selection of product configurations—standard or compact “skinny” drive options, controller kits, and complete storage sub-systems.

Shugart gives you more daily support—systems design, technical service, documentation and applications help.

And Shugart is responsive. We will give you the delivery schedule you want, and we'll meet that schedule. Ask our customers.

Experience. Technology. Responsiveness. No wonder two out of three OEM's specify Shugart.

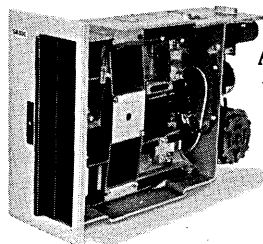

The leader in low-cost disk storage.

 **Shugart Associates**

435 Indio Way Sunnyvale, CA 94086 Phone: (408) 733-0100

Europe Sales/Service: 3, Place Gustave Eiffel, Silic 311
94588 Rungis, France Telephone: (1) 686-00-85

and is barely holding its own in its domestic marketplace against formidable IBM. But with encouragement and financing from the government, the Japanese have emerged from the back of the pack, late start and all, intent on establishing themselves as a power to be recognized in the international computing industry.

There previously were six major mainframe manufacturers in Japan, long recognized as being too many to be supported by such a small country. It took a while, but MITI has reorganized three groups for current lines, as mentioned above, and now two for future systems. One group consists of Fujitsu, Hitachi, and Mitsubishi Electric, while the other has Nippon Electric and Toshiba. Oki Electric, the sixth firm, has agreed to drop out and concentrate on peripherals and other gear. (Its alliance with Mitsubishi in marketing the current COSMO line will supposedly continue, but reports hint at dissolution.)

Fujitsu, Hitachi, and Mitsubishi Electric, for example, are the ones which recently established an organization to produce the ultra-LSI's. Shares in this joint firm, the Computer Research Institute, are held equally by the three parties. That's the way it was meant to be. And Fujitsu and Hitachi, before Mitsubishi joined them, also formed a joint venture called Nippon Peripherals Ltd., the company that exhibited the IBM 3340-equivalent disc storage system at the 1975 National Computer Conference in Anaheim, Calif. More significantly this firm signed agreements that give both Memorex Corp. and BASF the rights to this drive.

But when Fujitsu and Hitachi earlier agreed to cooperate in the design and development of a series of four computers, the so-called M Series, Fujitsu was to produce the M-160 (bottom of the line) and the M-190 (the top, the Amdahl 470 computer with slight modification). Then it added the M-180II. The three comprise its current line.

Hitachi likewise had the two models in the middle, the M-170 and 180 (more powerful than the 180II), and that's what it presently sells. And that competition is not quite what MITI had in mind. But the parties within each group have been forming tighter alliances with their partners, and that is exactly what MITI intended.

It is in this manner that the government and private industry are said to cooperate in Japan. There is no dictatorial power resident in government,

JAPAN'S COMPUTER CENSUS

The last time DATAMATION took a close look at the census of computers installed in Japan (December 1973, p. 130), we noted that at the end of the Japanese government's fiscal year in March 1973 there were for the first time more large-scale computers of local origin installed than those of foreign manufacture. At that time there were 666 large-scale machines of Japanese origin, 664 of foreign origin, in operation in that country.

When the books closed a year later, at the end of March 1974, the figures showed that for the first time the Japanese also dominated in the installation of very small computer systems, those valued at less than \$33,000 each.

The figures here show the status as of the end of calendar 1975, the most recent count available. They show the gains made by the domestic mainframe manufacturers there, leading in the number of computers installed in all categories and lagging only in the value of large-scale machines.

In the lower half of the large-scale class (\$830K-\$1.67 million) the Japanese lead in the number and value of equipment installed. But in the high end (over \$1.67 million), foreign vendors lead in number and value. What this says is that Japanese suppliers have not yet done well against the larger IBM 370 Series, Univac 1100, and the like.

In terms of installed value, not numbers, the market breaks down

like this:

IBM	26%
Fujitsu	16%
Hitachi	14%
NEC	13%
Univac	9%
Toshiba	4%
Oki	4%
Burroughs	4%
NCR	3%
Mitsubishi	3%
Others	4%

(These estimates were released by MITI, and seem to be accurately proportioned with the exception of the number attributed to Univac; Univac claims more like 18%, and that seems more reasonable given our estimates in Table 2.)

The largest number of computers, 10,389, are installed by an industry category that includes wholesale, retail, and trading firms. It is followed by the 4,009 in operation by finance companies, which does not include securities or insurance firms. Insurance companies have only 184 computers installed, but the average value of those systems exceeds \$1.2 million, and that's the highest average for any industry category.

In classifying computers by price, as seen below, the Japanese are using systems prices, not merely that of the mainframe component. And although some IBM computers, for example, are made in Japan, they're counted among those of foreign origin. *

Computers Installed in Japan Through December 1975

	Japanese Origin	Foreign Origin	Total
Large (purchase price more than \$830K)	1,110 \$1,985	840 \$2,200	1,950 \$4,185
Medium (\$130K to \$830K)	4,328 \$1,418	1,450 \$ 609	5,778 \$2,027
Small (\$33K to \$130K)	6,516 \$ 431	2,134 \$ 160	8,650 \$ 591
Mini (less than \$33K)	9,249 \$ 192	8,088 \$ 163	17,337 \$ 355
Totals	21,203 \$4,026	12,512 \$3,132	33,715 \$7,158

Source: Japanese Ministry of International Trade and Industry

Table 1.

Market Share by Manufacturer Determined by Number of Units

	Large & Very Large over \$830K	Medium \$130K - \$830K	Small \$33K - \$130K
IBM	35%	17%	11%
Fujitsu	20%	34%	25%
Univac	20%	17%	***
Hitachi	17%	12%	8%
NEC	5%	8%	18%
Burroughs	***	6%	14%
Toshiba	***	6%	8%
Mitsubishi	***	***	16%

*** small or nil
Source: Datamation estimates

Table 2.

MAJOR JOINT VENTURES AND TIE-UPS OF JAPANESE COMPUTER MANUFACTURERS

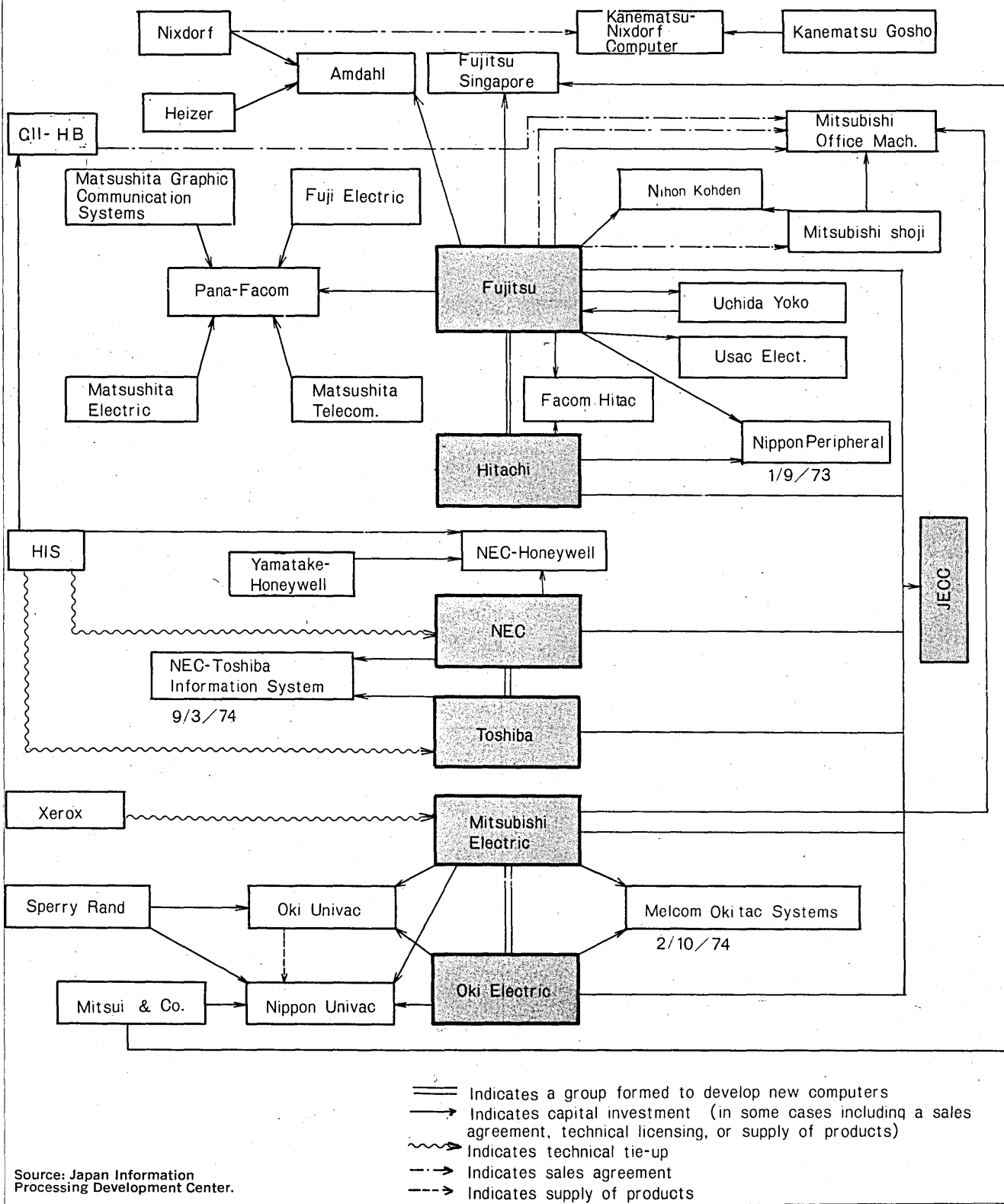

Source: Japan Information Processing Development Center.

Japan's computer industry is a web of entanglements involving domestic and foreign firms, the major links of which are shown above. Some of the internal linking, especially that shown by double bars between major mainframe manufacturers, is fos-

tered by the government through the Ministry of International Trade and Industry (MITI). Links to foreign firms are often for the purpose of picking up outside technology.

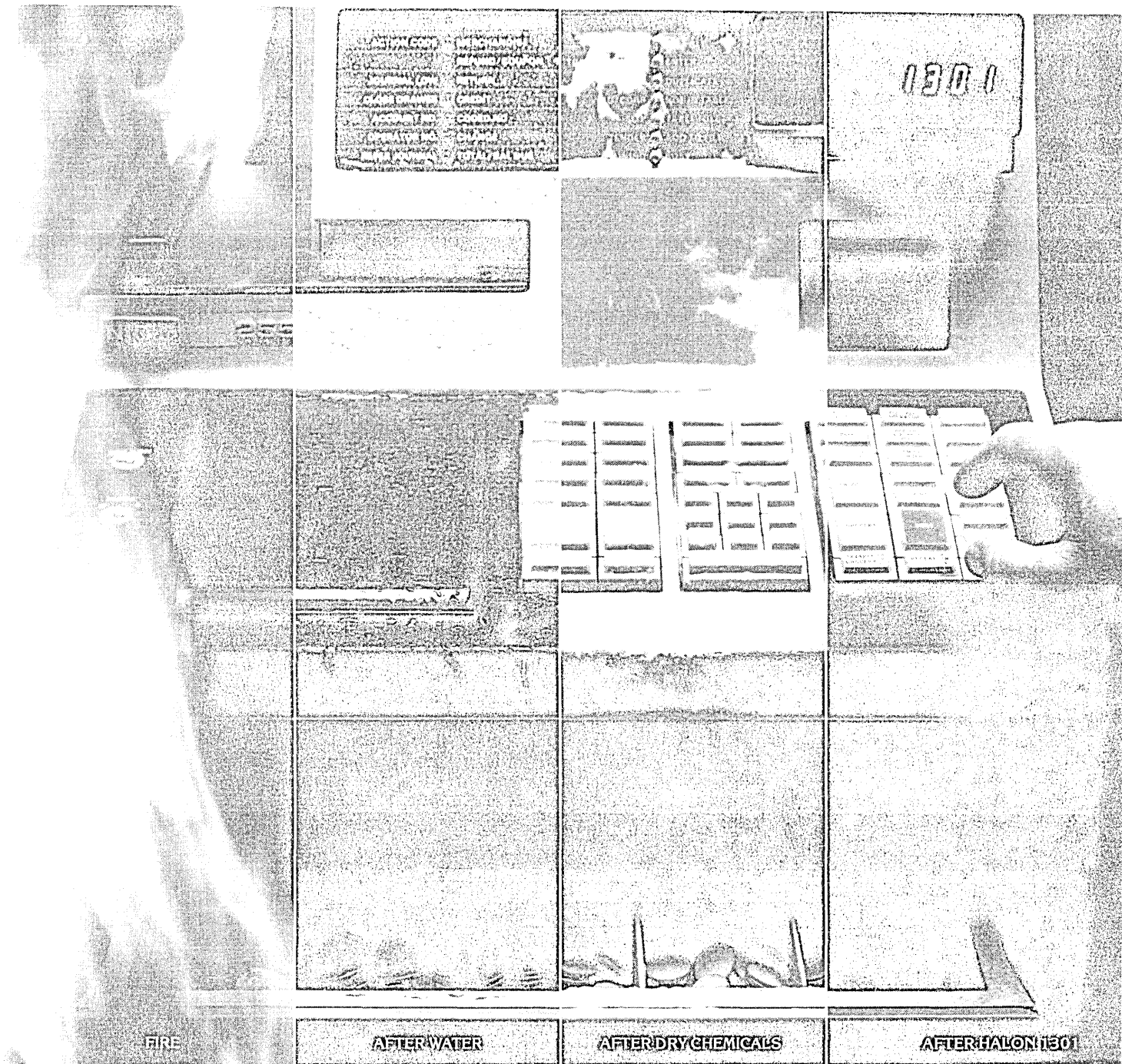

Halon 1301 can stop a fire without bringing business to a standstill.

Water or dry chemical fire extinguishing systems can cripple a business by damaging expensive equipment or harming priceless personnel.

Protect your company with a system using Du Pont Halon 1301 fire extinguishant.

Minimum disruption.

Exhaustively tested and industry-proven in ten years' use, Halon 1301 works by chemically interfering with combustion. Unlike other agents, it's a clean, clear vapor that leaves no

moisture or chemical residue for costly clean-up.

It's safe for use around sensitive electronics, because there's no thermal shock. And noncorrosive, nonconductive Halon 1301 causes no short or long-term damage.

Maximum efficiency.

Concentrations of Halon 1301 as low as 5% by volume in air extinguish fires and prevent reflash without danger of suffocating personnel. And because extinguishment can start before evacuation, systems

using Halon stop fires while they're still small—minimizing heat and smoke damage.

Covered by NFPA standard, UL listed/FM approved automatic total flooding systems using Du Pont Halon 1301 are available through fire protection equipment manufacturers and distributors.

For more information on protecting your company from its fire protection system, write: Du Pont, Fire Extinguishants, Germay Park, Wilmington, DE 19898.

Halon 1301 extinguishant stops fires. Not businesses.

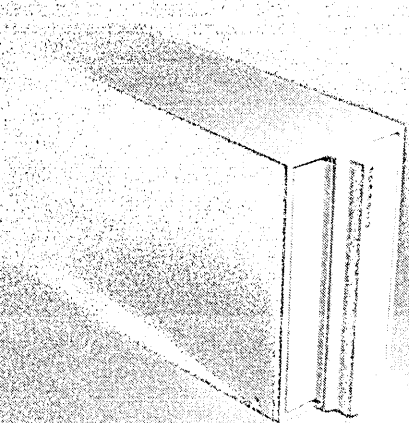

The mouse with an elephant's memory.

CalComp is the leading independent disk drive supplier. We've had over 7 years experience making large high capacity units. The trick, for us, was to squeeze this technology into a 10 pound box.

Our new 142 Floppy Disk Drive.

This is the latest in our floppy disk line. Its dimensions - 4.9 inches x 8.4 x 15 - are not exactly mammoth, but it has the

memory of an elephant.

It can hold 6.4 million bits of information. It has 6 millisecond track-to-track access time. And a transfer rate of 500,000 bits per second.

At these prices, you should get one for the house.

You'd pay more for a good stereo set than you will for this remarkable memory device. It's astounding that such a reliable,

high capacity device can cost so little.

We have shipped over 40,000 floppy disk drives, so you know we can deliver them in O.E.M. quantities. And we support our customers with the CalComp worldwide service network.

Call or write California Computer Products, Inc.,
DA M9 76, 2411 West La Palma Avenue, Anaheim, California 92801. Telephone: (714) 821-2011.

CALCOMP

JAPAN

no riding roughshod over a weaker opponent. But with the exercise of patience, the expenditure of many megabucks, and the setting of reasonable goals, the government usually manages to get its way. It takes time, as this reorganization will, but it's for the good of a nation or an industry. And the computer or information industry, as it's called, has been designated as vital to the future of the nation. It's knowledge-intensive, and it's a relatively clean industry, right in line with the goal of reducing pollution.

If that's the "state of the nation," here are the specifics on the major individual firms active within that state framework.

Fujitsu Ltd.

Fujitsu is the Control Data of Japan. That is in the sense that its predominant business is computers. And like Control Data it is aiming to spread its tentacles all over the globe.

In the year ending this March, Fujitsu showed computer-related sales of \$667 million, or 72% of its revenues. The remainder was in its communications activities. No more than a few percent of its business is outside Japan now, but it is making many moves to increase that. (*EDP Japan Report* showed that as of last September, Fujitsu had 250 systems installed abroad, mostly minis and the small-to-medium scale FACOM 230 series, and mostly in Australia, Brazil, and Bulgaria.)

The most significant of Fujitsu's foreign alliances is with Amdahl Corp. in the U.S. When Amdahl's public offering is completed, the Japanese firm will hold nearly 30% of this company. The technological exchange between the two, in patents and knowhow, is virtually total. Fujitsu's M-190 is very similar, though not identical, to the Amdahl 470/V6; very basically, it contains additional instructions and offers multiprocessing configurations.

The close liaison over the past four or five years between Fujitsu's operation in California and Amdahl has also resulted in the build-up in integrated circuit expertise by the Japanese firm; today it has begun selling its circuits in Europe and the U.S.

Under a manufacturing agreement, Amdahl has to purchase subassemblies for a minimum of 42 systems from Fujitsu by July 1977 and 12 more systems during each of the following two years. According to the prospectus, in marketing the two are "currently discussing a proposed joint venture, . . . which could include manufacturing and marketing of the . . . 470/V6 and M-190 in countries other than the

U.S., Japan, Canada, and Spain." The location: the European Economic Community. Some are guessing Sweden, since Fujitsu has already proposed M-190's for the Nordic Data Network in Scandinavia.

At the same time, the prospectus noted Fujitsu's hopes to bring the M-180 II, a system more powerful than and competitive with the 370/158, into the United States sometime after first deliveries in Japan next year.

In Spain, where the 470/V6 seems to be excluded, Fujitsu has entered a joint manufacturing venture with the

Spanish government and financiers. It will manufacture and export some of its FACOM 230, small-to-medium range systems. (Early 1976 figures show that Fujitsu had sold 1150 of the FACOM 230-8 series worldwide). As a result of this enterprise, it has also sold two M-190's in Spain so far.

Reportedly in the negotiation stage in Europe is some form of agreement with Siemens to market the big Amdahl and Fujitsu systems at the top end of Siemens' also-IBM-compatible 7000 line (ex-Unidata). However, this is not the accomplished fact it is re-

MITI-DIRECTED SOFTWARE COOPERATION

How the cooperation between government and industry works is shown by a more recent project that MITI has undertaken. A joint effort between the government and software firms to make it easier, faster, and cheaper to produce application programs entered its second phase this year with the formation of the Joint System Development Corp. (JSDC) in Tokyo. Its start coincided with the beginning of the government's fiscal year, on April 1. The company, capitalized at \$1.85 million, has the job of figuring out how to take small chunks of application programs, previously written and stored, and assemble them into working or nearly complete new programs.

Production of these software "modules" was ended last March, marking the close of a three-year first phase of the project that cost the government \$10 million. In that phase, software firms aligned themselves into one of five groups to produce the modules for a class of applications programs. (The five categories were business dp, management information, scientific/engineering, operations research, and automatic control.)

Now the problem is to label each module and store it in such a way that it can be retrieved and linked to other modules, but with hooks in the proper places for modifications and customizing. But JSDC, the new firm, will be concerned not only with the program generator that is to integrate the modules. It also will inevitably find that many modules must be rewritten or modified to make integration possible. Further, it is chartered to come up with a new language called CPL, "common programming language."

The government's plans to spend about \$25 million over the next five years. An equal amount is due from

JSDC's shareholders, which consist of 17 software houses and service bureaus plus 13 banks and other financial institutions. The spending of the funds, plus the \$10 million already spent, obviously reflects a concern over the gap in software prowess between Japanese firms and those abroad.

Although all this is designed to strengthen Japanese firms in the domestic and international marketplaces, the outcome of the program generation project should also be of wide interest among the world's user population. It is an approach to the automation of programming that appears similar to IBM's Application Customizer Service for the System/3 user. (This service, however, uses modules—or functions, as IBM calls them—only for business and operational dp applications.)

In the first module-building phase of this project, some 40 software companies pitched in with their personnel and funds. The five groups, however, each did their own thing with little, if any, management or coordination from a central body. There was not even agreement on the definition of a module. At least one group wrote its modules in FORTRAN. Another used CPL. And one group really didn't know what the others were doing. The result, say some observers in Japan, was a flop.

That is why the effort has been consolidated, they speculate, with the formation of JSDC under president Katsu Kondo. The 56-year-old Kondo previously had been president and chairman of the Kaihatsu Computing Center, and earlier spent some 13 years with MITI.

Today JSDC has only some 20 employees who, again, came from the parent software houses and service bureaus. *

Introducing the new BTI
A lot of plusses - with

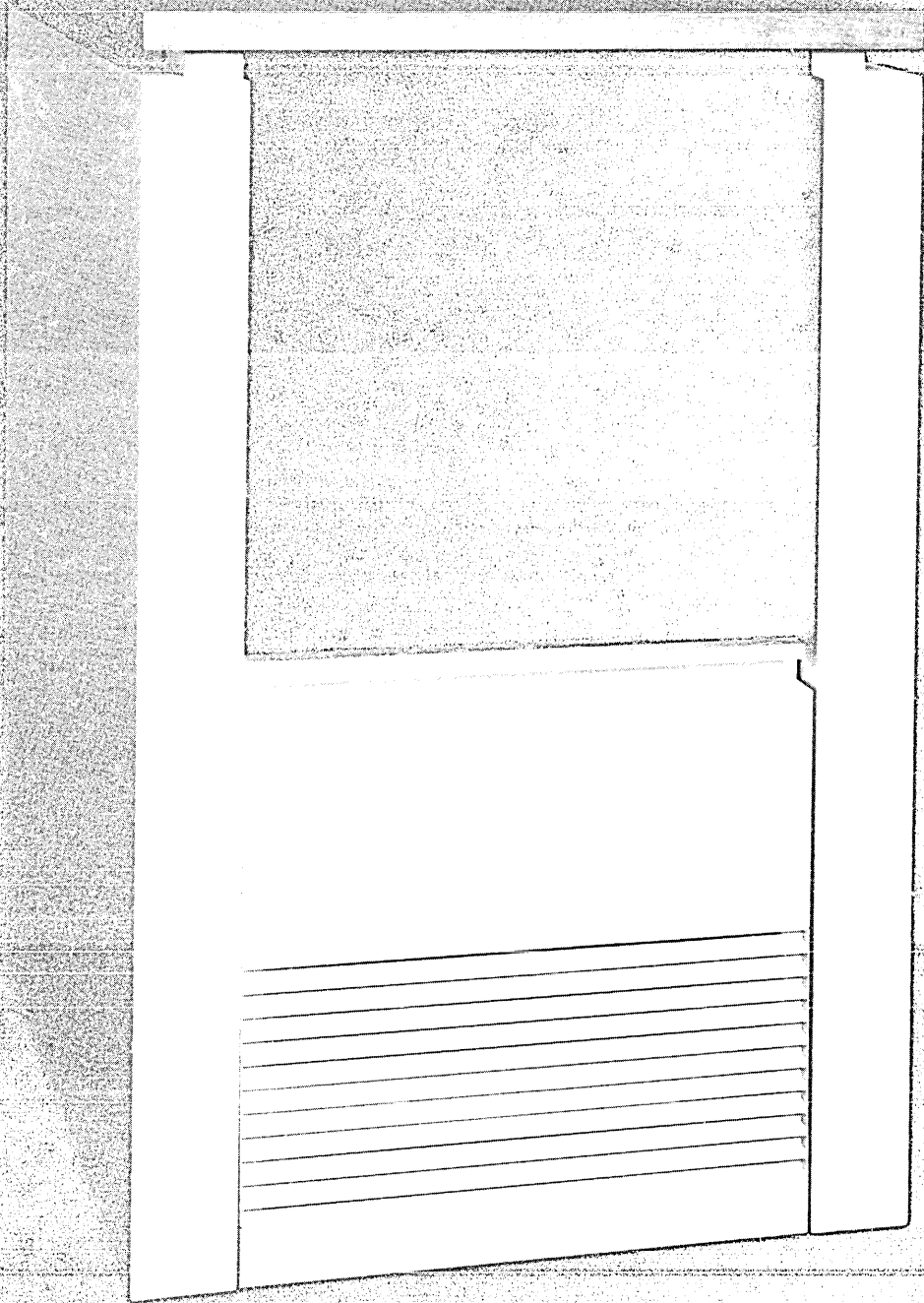

timesharing systems. one big minus.

Our new 4000-Plus minicomputer-based timesharing systems offer a number of plusses over the highly successful 4000 series:

String arithmetic, logical operators and many other language features now microcoded for faster and more efficient operation.

Magnetic tape software back-up and entry, using a new tape pack for easy handling and mailing.

Storage capacity in our smallest system is tripled—to 7.5 megabytes. And memory expansion (in 7.5 megabyte increments) is about one-third the previous cost.

Optional "polling ports," giving other computers direct access.

A revolutionary self-stacking structure eliminates the conventional system cabinet. All major system components are contained in stackable, interlocking cages. Cosmetic covers and top simply snap on. This radically new approach makes for the easiest system expansion, component replacement, and portability.

And while the new 4000-Plus systems give you these ease-of-use improvements, they still offer the advantages that made the earlier 4000 such a good timesharing system. Like hierarchal access, on-line software mobility, and a wealth of system management features. Like BASIC-X, the user language with the simplicity of BASIC and the sophistication necessary for demanding business and scientific applications. Modular expandability—in port capacity and mass storage. And 24 hours, seven-day-a-week on-line support.

The 4000-Plus series: a lot of plusses.

The one big minus? The Model 4000/15 timesharing system costs \$35,950—representing a \$20,000 reduction over the previous lowest-cost 4000. The bigger 4000/25 system is available at similar savings.

The new BTI 4000-Plus—
a lot more computer, for a lot less money.
Write or call for complete information, today.

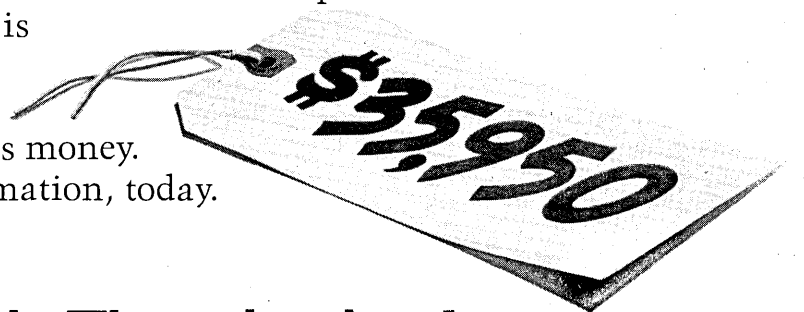

Basic Timesharing Inc.

Timesharing systems built by the company with timeshare experience.

Home office: 650 North Mary Avenue, Sunnyvale, California 94086. Sales offices: East: Cherry Hill, New Jersey (609) 795-2334; Southeast: Atlanta, Georgia (404) 433-0900; Midwest: Minneapolis, Minnesota (612) 854-1122; West: Sunnyvale, California (408) 733-1122

HOW THE MAINFRAME COMPETITION STACKS UP.

INTERNATIONAL BUSINESS MACHINES IBM	Hitachi	Fujitsu	Mitsubishi-Oki	Nippon Electric	Toshiba
System/32	HITAC 85		Melcom 80 Series Model 31	NEAC System 100	TOSBAC 1350
System/34					
8					
12	HITAC 8150	230-285			
15	HITAC 8150	230-285	COSMO 300		
System/370					
115	HITAC 8250; V1*	230-28; V1*	COSMO 300	ACOS 200	ACOS 200
115-2	HITAC 8250; V1*	230-28; V1*	COSMO 300	ACOS 200	ACOS 200
125	HITAC 8250; V2*	230-385; V2*		ACOS 300	ACOS 300
125-2	HITAC 8250; V2*	230-385; V2*		ACOS 300	ACOS 300
135	HITAC 8250; V3*	230-38; V3*	COSMO 500	ACOS 400	ACOS 400
135-3	HITAC 8250; V3*	230-38; V3*	COSMO 500	ACOS 400	ACOS 400
138					
145	HITAC 8450; M-160-II	230-48; M-160	COSMO 700	ACOS 500	ACOS 500
145-3	HITAC 8450; M-160-II	230-48; M-160	COSMO 700	ACOS 500	ACOS 500
148	HITAC 8450; M-160-II	230-48; M-160		ACOS 500	ACOS 500
155		M-170	COSMO 900	ACOS 600	ACOS 600
155-II		M-170	COSMO 900	ACOS 600	ACOS 600
158-3		M-170	COSMO 900	ACOS 600	ACOS 600
158 MP		M-170 MP	COSMO 900 MP	ACOS 600 MP	ACOS 600 MP
165		M-180		ACOS 700	ACOS 700
165-II		M-180		ACOS 700	ACOS 700
168-3		M-180		ACOS 700	ACOS 700
168 APS		M-190			
168 MP		M-190		ACOS 700 MP	ACOS 700 MP
195		M-190		ACOS 800/900	ACOS 800/900

*to be announced
 Information extracted from the *Auerbach EDP Notebook International*,
 Auerbach Publishers Inc., 6560 N. Park Drive, Pennsauken, NJ 08109

These comparisons are of a general nature and do not reflect a system's strength in any one particular application. They are meant to show which systems the manufacturers bid against each other.

ported to be. Siemens is not ready to make any decisions about more joint ventures, we understand.

In Brazil, Fujitsu is negotiating a joint venture to build minicomputers, another astute move in view of Brazil's tough import restrictions on computers.

The one major Pacific market where Fujitsu has gone in directly is Australia—a testbed for its expansion. As with many foreign firms in a new market, it initially bought its way in through high discounts and extensive, costly support. But with a good base developed, in the last year it has brought in ex-IBM management to take the operation to normalcy and hopefully profitability.

Fujitsu recently found another route into Canada and the U.S. (some also say the U.K.) by buying 20% of Consolidated Computer Inc., an ailing data entry and peripherals company whose major shareholder is the Canadian government. Fujitsu will “export its computer technology” to cci and “co-operate” in the manufacture and sale of small computers, computer peripherals, and terminals in Canada, and in sales to the U.S.

Fujitsu and Hitachi are sister companies in M series development and marketing, in the LSI project, and in future systems development. Fujitsu's international efforts, however, are completely its own.

Hitachi Ltd.

Hitachi is a giant electrical machinery and electronics concern which reported revenues last March of \$6 billion (which includes some subsidiaries' earnings). Only about 6% of its business is in computers. Our only figures are for the year preceding, which show \$333 million. The firm has about 14% of the Japanese mainframe market. Although it has sold more than 65 of the new M series models, much of that share is in the Hitachi systems, based on RCA Spectra designs via a license with RCA.

Like its sister company, Hitachi is seeking overseas expansion, although its progress appears slower and less clear than Fujitsu's. Japan's press has reported possible liaisons with CDC and Intel, but neither firm claims intentions to market any of the Hitachi line. The problem, sources tell us, is that like the Unidata line in Europe, the Japanese IBM-compatible systems are “not compatible enough” to be attractive in foreign markets.

Hitachi is taking shareholdings in some high technology companies in the U.S. Facsimile-maker Rapifax is one, and another is the little known Uppster, a developer of a high speed nonimpact printer which Hitachi is manufacturing. The firm is getting international markets in peripherals through Nippon Peripherals Ltd., the company it jointly owns with Fujitsu.

As noted elsewhere, the firm is selling IBM 3340-like disc drives to Memorex in the U.S. and BASF in Germany. (An amusing aside to this is that IBM was reported to have sent a warning letter about the similarity of its disc drive to the 3340; the press smelled a legal battle. However, NPL is licensed by IBM on 3340 technology, and all IBM says it complained about was that the NPL cabinet looked like its own. It's been changed.)

Mitsubishi Electric Company Ltd.

Mitsubishi is the company that has been grouped with Hitachi and Fujitsu for future developments. It has also been marketing the cosmo series with Oki Electric, a relationship that is supposedly to continue. That seems questionable, however, since government reports show that Mitsubishi has been selling nearly all the cosmo systems (88 as of March).

The firm is the smallest of the mainframers, with computer sales somewhere around \$100 million, under 5% of its total revenues. It has less than 3% of the Japanese computer market. The company is part of the multi-billion Mitsubishi Group, which makes it a good addition to the Fujitsu-Hitachi combine. (A Japan watcher told us he was hoping that ultimately the combine would exclude Hitachi, leaving Fujitsu to supply the technology and

Give your customers Air Freight

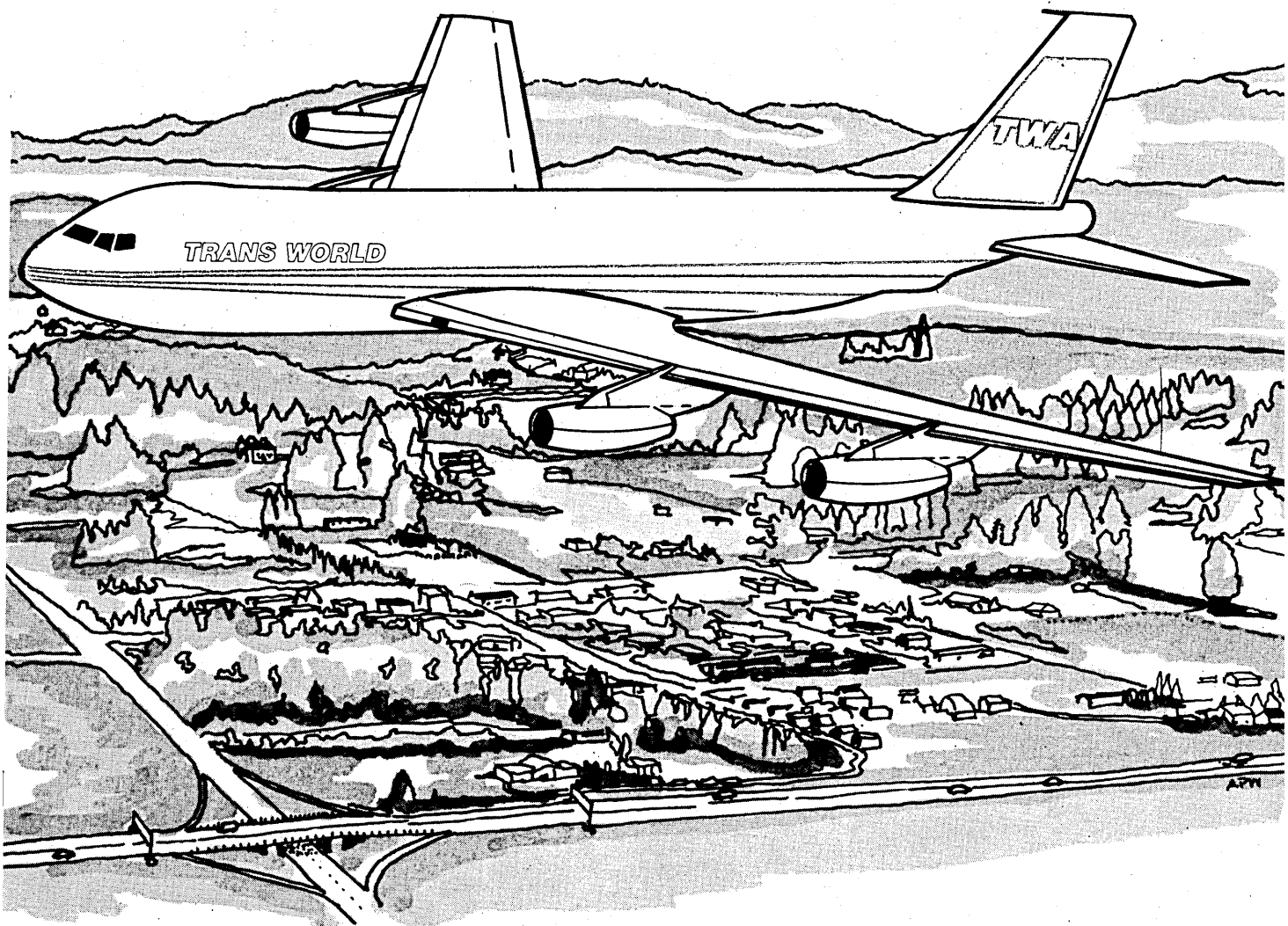

and give your competition something to worry about.

Any time you try to sell your product in a distant market you face serious competition from local manufacturers. After all, why should a customer tie up time and money waiting for delivery if he can get what he needs from local suppliers?

But when you offer your customers Air Freight you may be offering them just the reason they need to buy from you. With Air Freight you can promise the fastest delivery possible to customers in any market. And the increased sales could do a lot more than offset the added cost of Air.

There's much more to Air Freight than meets the eye. For this reason, TWA's put together a special

executive portfolio called "Air Freight Path To Profit." It's a concise look at how Air Freight can change the entire way a company approaches sales. It could help you decide whether Air Freight is right for you.

For your copy of "Air Freight Path To Profit," write: TWA, Director Air Freight Sales, Dept. DAT-976, P.O. Box 25, New York, N.Y. 10017.



Making it better.

AIR FREIGHT
A WORLD-WIDE MARKETAIR SERVICE

JAPAN

Mitsubishi to finance the operation. Apparently, he sees no hope for the resolution of the competitive animosity he feels exists between Fujitsu and Hitachi. "They'll never really get together.")

In any case, Mitsubishi's relationships in computing are confusing. It has ties with Nippon Univac, which markets its peripherals. Sister company Mitsubishi Corp. and its subsidiary Mitsubishi Office Machinery (MOM) market some Fujitsu systems. MOM is also the marketing agent for CII-HB computers, a relationship that started with Machines Bull in France more than a decade ago.

Oki Electric Company Ltd.

Oki teamed as noted with Mitsubishi to market the cosmo series; but Oki's stronger alliance is with Univac. Oki-Univac, of which Oki owns 47%, manufactures the entire Univac 90 line up through the 90/80 (called 90/800 there). It also owns a small percentage of Nippon Univac Kaisha Ltd., the marketing arm for Univac in Japan. We hear too that it may team up with Univac in LSI development and production, since it was eliminated from the ultra-LSI project.

The firm's computer revenues in

fiscal 1975 were \$163 million, or about 40% of sales. It has about 4% of the Japanese mainframe market, although we're unsure if its shares in the Univac production are accounted for in that figure.

Nippon Electric Co. Ltd. and Tokyo Shibaura Electric Co. Ltd.

NEC computer sales are nearly 25% of its revenues, and amounted to \$294 million in fiscal 1975. It is the third largest manufacturer in Japan and specializes in the small and medium-scale systems of the ACOS line it markets with Toshiba. Toshiba's reliance on computing is less, with 6-7% of its total in computing revenues, which were \$180 million in fiscal 1975. As of March, these two firms had sold 240 of their current ACOS lines.

If Fujitsu is the Control Data of Japan, NEC and Toshiba are Honeywell and GE. That is, NEC has been using Honeywell technology since 1962, via license. Toshiba was a licensee of GE's for six years before GE's operations were sold to Honeywell. Thus, the ACOS Series 77, the current product line, is based on the Honeywell Series 60. In fact, the ACOS operating system is a descendant of the GECOS operating system, and Honeywell is planning to use some of the Japanese modifications in

its own GCOS. We hear too that some NEC-Toshiba designs in virtual memory systems will be used by HIS in future large-scale systems.

Honeywell Information Systems buys some components and peripherals from the Japanese firms. Its Italian subsidiary recently signed a contract for \$27 million worth of their disc drives over the next three years. And HIS will surely be a customer for the products of the ultra-LSI research in which NEC and Toshiba are involved.

One last confusion here is that Honeywell markets NEC small business systems as System 6 in Australia; no relationship to HIS's level 6 mini is claimed. Meanwhile, CII-HB has renamed its Unidata 7000 products Series 77, which is also the number on the ACOS series.

In our wildest nightmares, we envision a day in the U.S. when NEC-Toshiba will be marketing System 6 and 77 series against the HIS level 6 and against a Level 64 model manufactured by CII-HB but brought in by MOM, which also has some FACOM and Univac equipment in its portfolio.

And so it goes. As with the rest of the world, Japan's dp vendors continue to become more entangled with other Japanese firms and with outsiders in a struggle for national independence and, sometimes, corporate survival. *

why lease alpha when tso is free?

Responsiveness, ease-of-use, minimal system overhead,
flexibility, reliability, user satisfaction, lower total cost, . . .

Interested?

Call Ward Clark at (202) 244-1900 or your nearest COMNET
marketing representative for details on installing ALPHA
on your IBM 360/370 computer system or using ALPHA
on COMNET's nationwide time-sharing service.

COMNET

COMPUTER NETWORK CORPORATION

5185 MacArthur Boulevard, Washington, D. C. 20016 (202) 244-1900
1250 Broadway, 20th Floor, New York, New York 10001 (212) 594-6150
301 Fifth Avenue, Suite 1403, Pittsburgh, Pennsylvania 15222 (412) 288-0134

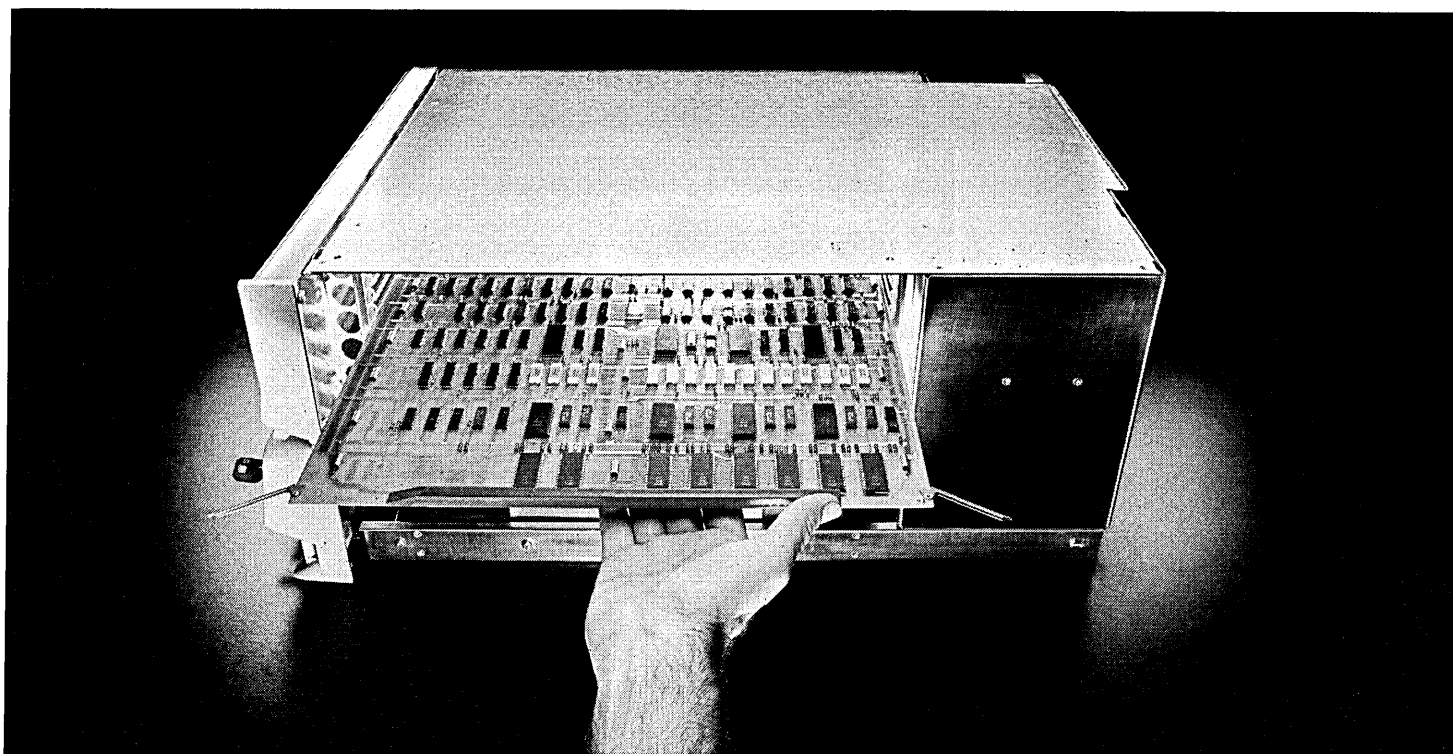

Give your data communications system a little goose and it'll put out ten times as much.

Open up the back of any Data General communications system, pop in our single-board DCU/50 Data Control Unit, run through a little step called COMGEN and stand back. Because that system can start pumping out ten times as much data. And possibly a good deal more.

What makes this all possible is a rather clever piece of engineering.

We've designed the DCU/50 as an intelligent programmable controller. So it takes over jobs the CPU used to do. Things like character handling and code conversion. Which frees up the CPU processing power and speeds up total systems throughput.

On the other hand, you may not need more throughput. Instead, you may need more lines or different types of lines. Both of which are just as easy to get. You just plug in some different boards.

We make modular synchronous and asynchronous multiplexors you can mix

in any proportion. They can handle anything from one to sixteen lines, are fully software supported and work equally well with or without the DCU/50.

Which brings up a rather significant point.

When you buy your communications equipment from Data General, you can get exactly what you need right now. And later, if you need more throughput, more lines or different types of lines, you won't have to throw out anything. All Data General communications hardware and software are completely compatible. So you can add on to what you already have.

Write for our free brochure, "The Sensible Way to Use Computers in Data Communications" and detailed information about the DCU/50 Data Control Unit.

And if that isn't enough information, we'll send a sales engineer who can also put out ten times as much.

DataGeneral

Data General, Route 9, Southboro, Mass. 01772 (617) 485-9100. Data General (Canada) Ltd., Ontario.
Data General Europe, 15 Rue Le Sueur, Paris 75116, France. Data General Australia, Melbourne (03) 82-1361

You can depend on Exide UPS.

They do.

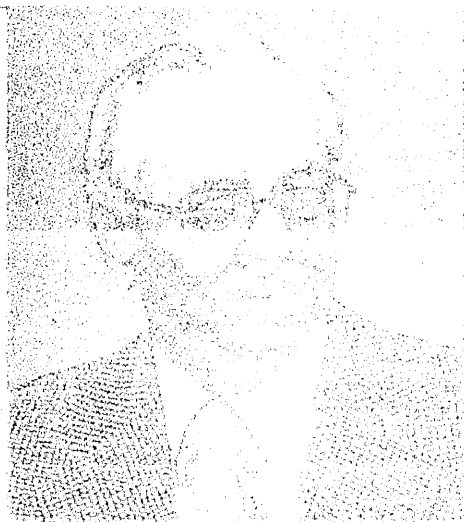

Exide backs up its UPS reliability claims with a 24-hour response service department. WEA/WHO has had three 200 KW UPS Units in operation since June, 1975, in its St. Louis, Missouri, facility. In June, 1976, Exide units have been installed to provide full emergency power for 15 minutes. And two more units will be installed in Exide UPS's

Chicago, Illinois, Section Manager,
Wheeler Douglas Corporation

The installation of our Foreign Currency Trading System requires a reliable computer file management system and our UPS's provide the additional back-up for computer power.

Philip D. Quarles,
Vice President, Data Processing,
Wheeler Douglas Corporation

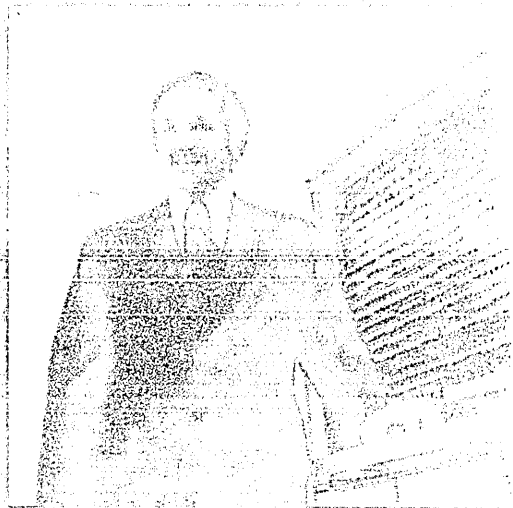

Exide UPS systems are protecting some of the largest computer centers in the country. An Exide Uninterruptible Power Supply system filters out the spikes and transients commonly found in raw utility power. And, depending on your time requirements, an Exide UPS system will

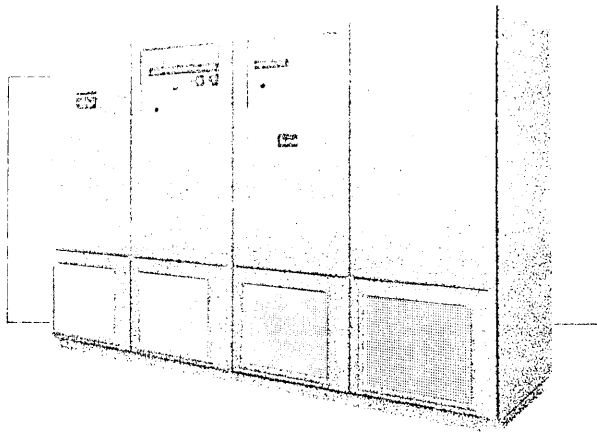

continue to feed smooth, constant power during utility blackouts and brownouts.

Major computer users who rely on Exide UPS systems are enthusiastic about their selection of this equipment. Quoted below are Exide customers whose comments are based on experience. There are many more, since Exide has been an UPS system supplier for more than a decade.

Exide is the only UPS manufacturer that makes all the major components: Rectifier/charger, stationary battery, static inverter and static switch. This means that your UPS will be carefully designed as a complete system. All the components, from the utility power takeoff to the computer interface, have a single source of responsibility—Exide. You can depend on Exide UPS.

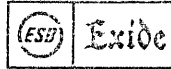

EXIDE POWER SYSTEMS DIVISION,
ESB INCORPORATED, Raleigh, N.C.

Exide is a registered trademark of ESB Inc. Exide and its products and systems Copyright © 1976 ESB Inc. All rights reserved.



"We chose the Exide system primarily because of the ease of maintenance and repair. Due to its design, a person with basic electronic knowledge can troubleshoot and repair most features. Also, we were impressed with the Exide representative's knowledge of their product and his knowledge of UPS Technology. Along with this, their equipment pricing was very competitive."

Robert Watters, Maintenance Engineer,
Dallas Federal Savings

"When the energy crunch started in late 1973, COMPU-SERV realized that if we were going to continue to provide reliable computing services to our users, we would need to find a reliable, cost-effective 'uninterruptible power source.' After talking with several possible vendors, it became apparent to COMPU-SERV that Exide Power Systems could deliver such a system as a total package in a reasonable time frame. Our 250 KVA UPS has been on-line for over eighteen months now. We are pleased with the increased computing reliability this Exide UPS has allowed us to provide the remote users of our nine large systems."

Len Kaiser, Site Manager, COMPU-SERV



OUR SHORT DROPS COULD BE A WHOLE LOT CHEAPER THAN YOUR LONG HAULS.

If you're thinking of expanding your communications network, then a Cable & Wireless leased circuit system is what you need. If you're already running a leased circuit there's more than a chance that if you let us look it over, we could make it a lot more cost-effective.

And, if you're a company whose major interests are in the Far East or the Middle East we could

certainly save you money.

Cable & Wireless have the computer-switching centres which can pick up your messages and transmit them more cheaply.

Our switching centre in Hong Kong, for instance, means that your traffic can be passed through there and routed on by a 'short drop' to, say, Tokyo and Manila at a tremendous saving in cost against a 'long-

haul' system direct from your head office.

Similarly, our switching centre in Bahrain can cut your costs in the Middle East.

But there's a lot more to it than that, and we'd like to explain it to you.

If you think you'd like to listen, contact us at the address below. We'll send you literature, or have someone call.

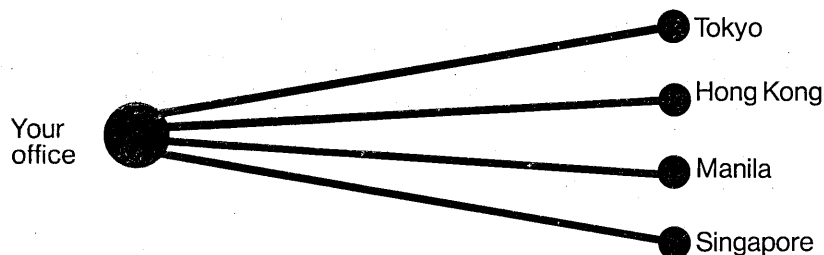

THE LONG HAUL.

This system could be costing you much more than it need!

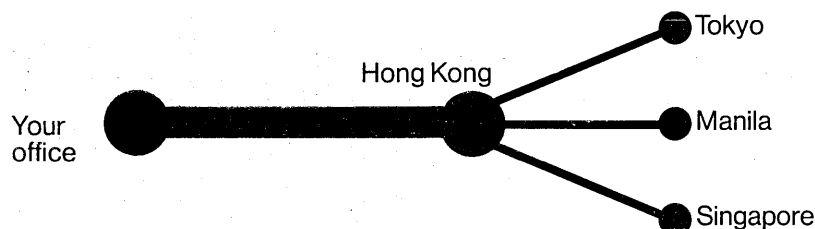

THE SHORT DROP.

A Cable & Wireless leased circuit using short drops like this could cost you much less than you think!

 **CABLE &
WIRELESS**

Keeps you in touch with the world.

Cable & Wireless, International Commercial Dept., Mercury House, Theobalds Road, London WC1X 8RX. Tel: 01-242 4433. Telex: 23181.

U.S. Office: Cable & Wireless (NYK) Inc., Graybar Building, Suite 2020, 420 Lexington Av., New York 10017. Tel: 212-889-9020. Telex: 12094.

The Intelligent Warehouse

by James R. Benson

Man and machine readable forms are the key to accurate and speedy receipt, allocation, and shipping of merchandise at this Levi Strauss Distribution Center—and all of it completely controlled by computer.

The vital link in the communications chain which governs and directs the automatic material handling operations at the Little Rock Distribution Center of Levi's Panatela Division, Levi Strauss & Co., is a man and machine readable business form. Every movement of merchandise during receipt and shipment is overseen by computer, the operations of which are based on data relayed from this business form by optical (laser) scanning stations. One might even say that this scannable business form, really a label, dictated the layout and design of this recently built center (a facility which also represents the largest capital investment ever made by the company).

All this started several years ago. More shipping capacity was needed for the Panatela Div. sportswear products, and the decision was made to construct a new central distribution facility for this growing line of ready-to-wear pants, tops, and jackets. Little Rock, Ark., was selected as the most suitable location.

In planning the center, we were determined to make use of the latest ideas and technology in materials handling, including on-line real-time computer controls. Today, virtually every aspect of this 425,000 square foot facility, with storage capacity for 9.2 million garments, is directed by computer. And, in enabling us to handle over 44,000 stock keeping units and to ship and receive more than 250,000 cartons each month, the scannable business label plays a crucial role.

The scannable label

Computer control of our materials handling involves the identification and verification of carton contents in both receiving and shipping operations, as well as the automatic de-

termination of conveyor routes and destinations within the warehouse. To do this efficiently and accurately, we needed carton labels imprinted with a bar code that could be read by laser-based scanning equipment which would then pass on the information, via an BIM System/7, to be compared against data bases on the central computer, an IBM 370/145.

The carton number (along with the matching bar code) is the key to receiving, putaway, replenishment, and shipping operations. For incoming merchandise, the label form is referred to as the receiving tag; it is a five-part form produced by Courier Citizens, Inc., South San Francisco. For outgoing merchandise, the label form used is referred to as a shipping tag; it is a single part form designed by Standard Register Co., of Dayton. Both have preprinted numeric characters as well as bar codes.

The system

In an overall view, the company's home office in San Francisco issues cutting orders to various plants around the country that manufacture the merchandise. The same office coordinates the transfer of the merchandise from these plants to the Little Rock Distribution Center, and later in the process, transmits orders to Little Rock for shipments to retailers.

In order to move the goods in and out of the Little Rock facility as speedily and efficiently as possible, the computer system, of course, plays an indispensable role. The components of the system are the System/7, with 16K storage, connected through a 3704 communications adaptor at 7200 baud using BTAM to the central computer complex, which consists of an IBM 370/145, using os/vs1 with ¾ mega-

byte storage and eight 3330 discs. There are nine IBM 3277 on-line terminals and seven 3284 and 3286 on-line printers, located at strategic points about the warehouse, which connect to the 145.

The 145 maintains data bases under IMS. We use batch IMS, in conjunction with Intercomm, and have 17 physical data bases (which include, among others, "Receiving," "Reserve," "Product Code Master," "Shipping," "Pack and Hold," and "Zone/Module") and five logical data bases.

The System/7 controls the movement of the cartons of merchandise to various conveyor sortlines in the warehouse. There are, in fact, approximately 13 miles of wire connecting the System/7 to the equipment in the distribution facility.

The major components of the material handling system are: (1) conveyORIZED sort lines for receiving and dispersing by storage zones; (2) carts pulled along towlines for feeding cartons into zoned shelf storage, including a 145,000 square foot mezzanine; and (3) conveyORIZED sortlines for order filling and shipping. The storage area is divided into about 30 zones, and within each zone are approximately 29 modules. These modules are further subdivided into sections and levels. This graded classification allows for accurate and speedy stocking and retrieval of merchandise by product code and size.

The receiving process

For the computer to route the cartons to the appropriate location in the warehouse, there are a sequence of steps which must be completed *prior* to the time the numbered bar coded cartons pass the scanner.

Before the merchandise is actually

WAREHOUSE

received, the home office in San Francisco has informed the Inventory Control Group in Little Rock by means of "due in" reports what specific goods by product codes and sizes (not yet by carton numbers) are to be expected. A member of the control group at this time assigns storage space in the warehouse to the incoming merchandise. This assignment of a predetermined home for the goods is made at the zone and module level via an on-line terminal transaction which enters the information onto the IMS data bases. If this has not been done, the incoming goods cannot be processed.

When the merchandise arrives at the Distribution Center, a packet con-

The detailed carton information for each receiving tag is now associated within the data bases to the particular zone and module assignments already preestablished for the goods from the "due in" reports. In other words, the computer now determines a location assignment for each specific carton to a particular zone and module. And again, this information is in the computer before the cartons are actually unloaded. The estimated weight of each carton, plus contents—there is a weight matrix by size for each product code maintained on the computer—is also calculated at this point for a later check. This phase of the operations is labeled PSI processing.

After PSI processing, and still prior to unloading the trailer-load of cartons, an on-line terminal transaction is

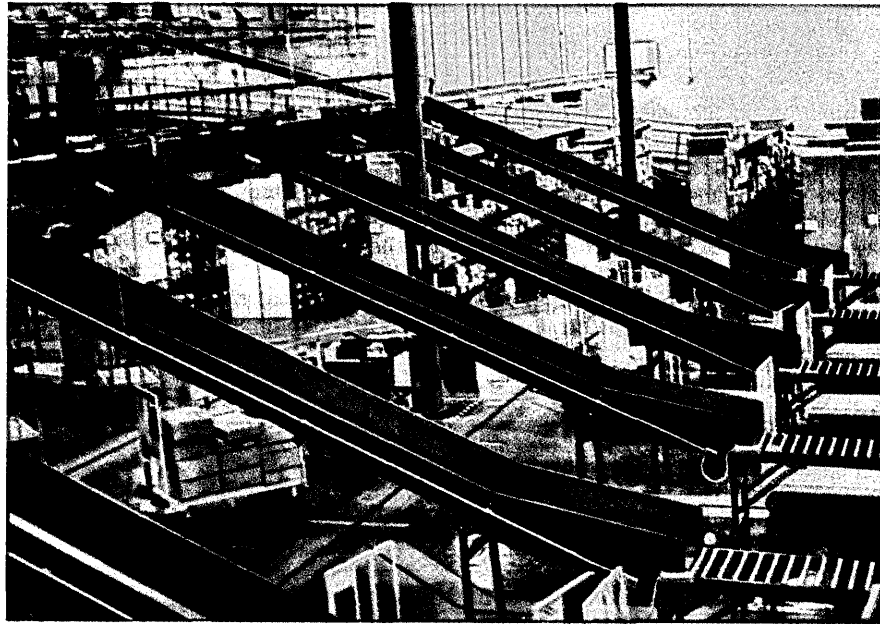

A System/7 controls the sorting of cartons along these receiving conveyor sortlines; each sortline is targeted for different storage zones.

taining one part of the five-part receiving tag for each carton in the truck-trailer is taken to keypunching. After keying and verifying, the detailed information is then loaded onto the IMS data bases. The status of the carton data is now "due in." This detailed information, which we refer to as Plant Shipment Information (PSI), contains for each carton the bar code (i.e., carton number), cutting order contract number, product code, sizes (there may be more than one size per carton), and number of units in the carton. (In one particular case, this information is teleprocessed directly to Little Rock from a plant in Amarillo, Texas, by means of a Data General minicomputer with an auto-answer modem using TCAM, and then edited and loaded onto the data bases at the Distribution Center. The possibility exists of applying this technique to other facilities also.)

entered, called "Receiving Cycle Initiation." What this transaction does is initiate the selection by the computer of the particular conveyor sortline paths, by zone, for each carton. This information is gathered into a table in core, and is ready for use by the System/7-initiated request as soon as the unloading of the cartons begins.

The "Receiving Cycle Initiation" also initiates the printing of "Putaway Guides" on an on-line IBM 3284 printer located in Receiving. The putaway guide contains the following information: the conveyor sortline number, the zone number associated to the cartons which will be routed down that particular sortline, the product code, and the number of cartons by product code. The guide also identifies the predetermined storage modules within the zone the product codes are assigned to.

Also, the number of cartons to be

routed down a particular sortline, divided by the number of cartons a topline cart will hold, determine the number of putaway guides printed. There is one putaway guide attached to each topline cart. The topline carts are routed from the receiving area to the storage area, also automatically, by means of cables in the floor (just like the San Francisco cable cars—but without the hills).

Unloading

The cartons are now ready for unloading onto the conveyor system. Each carton passes the laser beam scanner which reads the numbered bar code, thus indicating to the System/7 that this particular carton has physically entered the actual receiving process.

The carton then passes over an in-motion scale which weighs it; the carton's weight and number are transmitted by the System/7 to the 145. (The status of the carton is now changed to "in-process.") If this weight differs from the estimated weight as calculated during the PSI processing, the carton is "rejected" from the sortline by being routed to the Quality Assurance (QA) area, and is so flagged on the data bases. In QA, a self-adhesive "rejection reason" label is printed on an IBM 3284 printer, which includes enough information—carton number, estimated weight, actual weight, rejection reason, and receiving cycle number—so that corrective actions may be taken.

Say there is a shortage of a pair of pants in the carton. The "reserve" data base is now changed to reflect the actual contents of the carton, and this is done on-line. (The "receiving" carton data base is not altered, in order to reconcile with a manifest which also accompanies the truckload and is to be discussed shortly; in other words, the "receiving" data base equals what is on the manifest, while the "reserve" data base equals actual receipt.) These cartons are now returned to the conveyors for proper storage sorting.

Those cartons which were not rejected for weight discrepancies continue moving on the conveyors. The 145 does all the analysis such as the weight checking just mentioned, sortline routing, random auditing, and specific auditing (plant, contract, manifest, particular product codes). By definition, auditing is the checking, in QA, of say 10% or 20% (or sometimes even 50%) of a shipment to see that the quality of craftsmanship in the manufacture of the clothing is up to preset standards. Such audits can be requested on-line for each truckload, as desired.

The most important advantage of this automated system is that it knows

where every carton is at every moment. The cartons not rejected or audited do not stop moving on the conveyors. The System/7 uses photocells to track the cartons throughout the entire routing operation. The 145 must respond to a routing request from the System/7 within an average of two seconds, or the System/7 will automatically route the cartons into QA with an appropriate message printed on the System/7 console.

At the conclusion of the receiving process, an on-line "load reconciliation" report is requested by a checker for comparison of the cartons actually received to what the manifest that accompanied the incoming truckload states. If there are discrepancies, a "manual discrepancy" report is prepared and forwarded both to the plant from which the truckload originated and to the home office.

"Putaway"

The cartons now at the end of the incoming conveyors are at this point routed by towline carts to the warehouse storage area and "putaway." The stocker references the "Putaway Guide" attached to the towline cart which directs him to place the cartons

in the proper zone and module, and also to "active" and "reserve" storage locations within the zone/module. Although not mentioned above, the "active" determination is also made during PSI processing. This designation would be made for a newly set up module where there currently are no goods, or when an already designated "active" bin has been flagged by computer "replenishment" (to be discussed shortly) as "stocked out." (A computer controlled noncontact air driven "Label Aire" device flags those cartons as "active" during the receiving process by automatically placing a green self-adhesive label on the carton.) The "reserve" status is exactly what the designation implies. On the data base the stock is kept as units, in the "active" bins, and as both units and cartons (by carton number) in "reserve" bins. (Actually only one carton is physically open at any one time in a given active bin.)

The preassigning of goods (before the actual unloading) was made down to zone and module, and appears so on the "Putaway Guide." The stocker now places the merchandise into sections and levels. In order for the computer to keep track-of the units down

to the most precise level, the stocker must keep the computer informed of this section/level information. This is done by the stocker removing a form which is another one of the parts of the original five-part receiving tag for each carton; it has been included in a polyethylene envelope which is attached to the front of the carton. On this form is a preprinted area on which the stocker now records his employee number and the zone, module, section, and level for the particular carton; the carton number is preprinted.

These forms with section/level information are periodically gathered throughout the day for keypunching and processing on-line. During this on-line processing, the carton status is changed in the data base to "allocatable," and audit logs written to a data base. A check is made by computer on whether the carton number is valid, the location recorded for the carton contents by product code and size is valid, etc. If there are any exceptions, they appear on an on-line "exception report" which is generated at the completion of each batch and logged on a data base. These exceptions (such as stocking in the wrong place), are then researched and corrected via an on-line

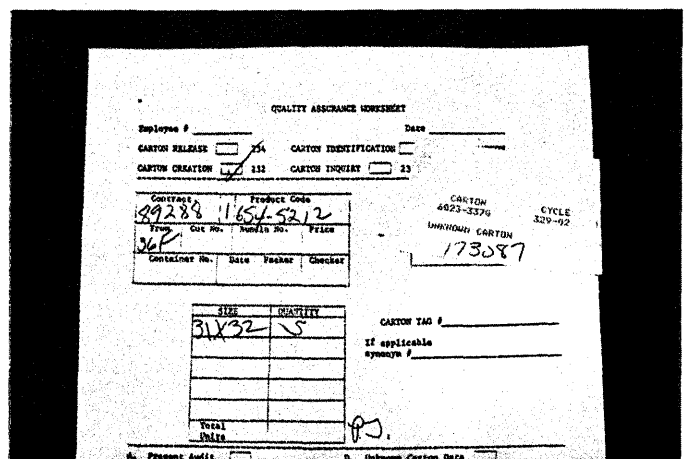
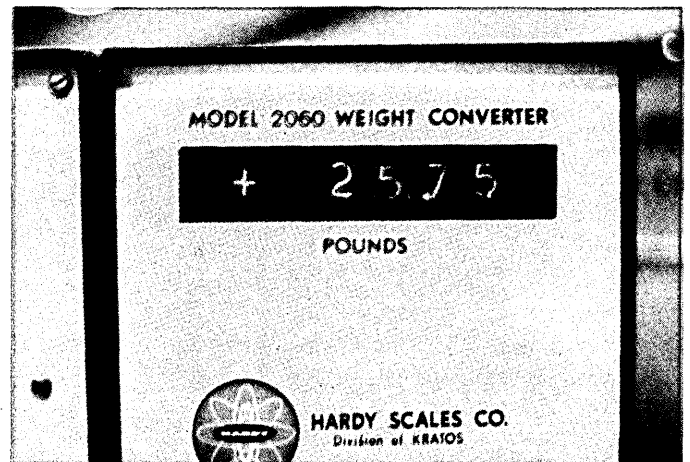

Clockwise: At the start of the receiving cycle, each carton is scanned, its weight (carton and contents) relayed from an in-motion scale to the System/7, and if "rejected" from the sortline (say for weight discrepancy), is routed to Quality Assur-

ance where an on-line printer produces a "reject" message. A terminal operator in Quality Assurance keys in corrected data to keep the data bases current and accurate.

WAREHOUSE

terminal and removed from the exception list. To ensure that proper action is taken for each exception, no exception is deleted from the data base until the situation is actually corrected.

"Replenishment"

As units are shipped out throughout the day, the "active" bins are being depleted. To ensure that "active" bins do not "stock out" during the order filling cycle, the "replenishment" program determines the amount of goods that should be moved from "reserve" to "active." This determination is based, again, on the bin size (number of inches), packing factor (number of

garments per inch), the bin's current unit quantity, and the quantity to be picked from that particular "active" bin.

The system then generates the appropriate number of "replenishment" cards, which are prepunched 80 column cards containing the carton number, "reserve" location (zone/module/section/level), and the "active" location (zone/module/section/level) the goods are to be moved to. The stockers, of course, use these cards to move cartons from "reserve" to "active." As the cartons are selected by the computer for "replenishment," the status of that carton on the data base is updated accordingly; and the cards, after the relocation of the merchandise, are reprocessed on-line to verify the move-

ment of the goods, to make appropriate inventory adjustments, and to generate "audit logs."

Data base synchronization

At the time carton statuses are updated on the data bases, an "audit log" is generated. The audit log contains the program number, date, time, the particular 3277 terminal (if on-line) requesting the transactions, the carton number, product code, size, units, and "before and after" inventory balances for that particular product code and size. All inventory adjustments, processed either on-line (98% are) or batch, generate an audit log, which reflects the movements of goods from one inventory category to another.

These audit logs are merged on a fiscal month's basis and maintained for a fiscal year. It is possible to track the receiving history of a carton or product code and size by these audit logs.

On a daily basis, the audit logs are used for balancing forward the inventory reports by category within the Distribution Center. These logs are also transmitted to San Francisco to maintain the home office's inventory synchronized with ours. (Transmission is accomplished through use of a 4800 baud modem and a WATS line on a dial-up basis.)

The level of precision of inventory at the home office is not maintained by zone, module, section, and level as ours is, but rather on a total product code and size basis. In addition to controls verbally verified, computer operator to computer operator, at the time of transmission, a daily control TWX is also transmitted between the Little Rock data control section and Panatela Inventory Management in the home office. These controls ensure that the processing of all adjustments be timely and accurate at both Little Rock and the home office.

Order allocation

Customer orders are channeled through our San Francisco headquarters and are received from salesmen on a daily basis. The orders are entered into the system via OCR, using each salesman's original handwritten order form. Any edit errors generated at the time the orders are scanned are corrected via an on-line terminal transaction. (The home office computer center consists of IBM 158 and 145 mainframes.)

Once the orders have been booked, assuming all errors have been corrected, they are then allocated according to dates, percentages of completion, inventory availability, etc. The allocation process matches the orders against the inventory which Little Rock has transmitted to the home office on a daily basis. The allocation process also prepares a daily workload

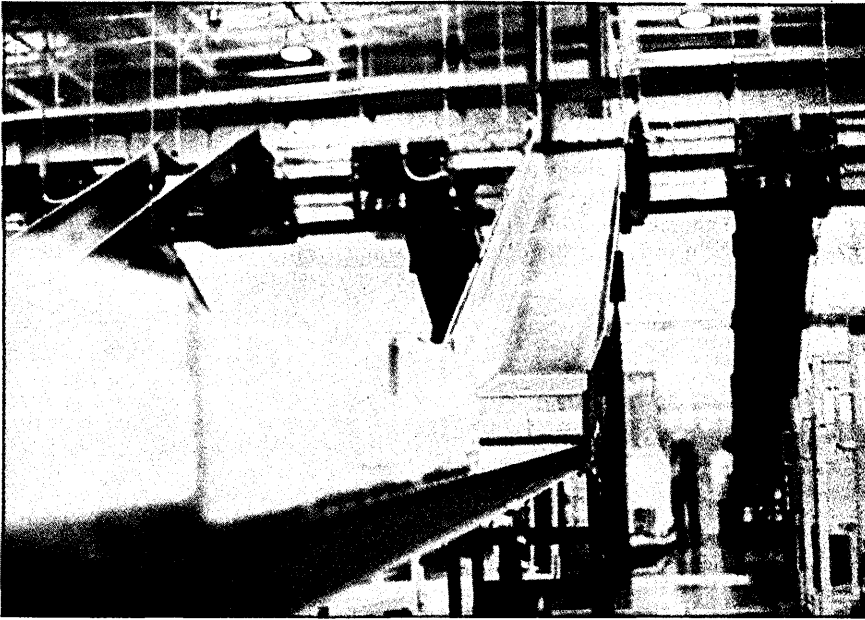

Cartons are sorted down a receiving sortline. From sortlines to storage shelves and from storage shelves to shipping, cartons are moved on towline carts attached to cables in the floor. (Note the putaway guide attached to the clipboard on the towline cart.)

file on tape to be transmitted to Little Rock via tape-to-tape transmission, and which contains information such as customer name, address, special handling and shipping requirements, along with product code, size, and unit detail information. As these orders are placed on the file, they are also added to the home office "Outstanding Picking Ticket" file (orders allocated, but not yet updated as shipped).

Once the allocated workload tape has been received at Little Rock, it is processed through a series of batch programs which takes both the "carry over" orders (those not yet completed) plus the new orders just received, and reloads the data bases to be used in the next day's on-line processing. During this series of programs, the individual customer's orders are divided into work units based on quantity, styles, colors, sizes, warehouse locations, and packing factors (garments per inch). Then for every carton generated for a shipment, the computer generates a bar coded picking ticket label form.

We wanted the bar coded shipping labels to serve as both picking tickets and packing slips, to provide records of order fillers' work (because wages are based on incentives), and to have preprinted numbers that could be read at a distance. After several design conferences with Standard Register and some test runs, we developed a one part continuous form, prepared as a pressure sensitive label, 3½" by 14⅞", and divided into two sections by a vertical perforation. The left side is the shipping label, with an eight digit consecutive number printed in both numeric characters and bar coded lines; the right side is the packing slip. The bottom sixth of the shipping label side of the form is used for incentive coupons. There are five of these coupons, although normally only one or two may be used, and they are die cut to be easily removed without disturbing the rest of the form.

Each ticket carries detailed information about the customer (such as name, address, purchase order number, and account number), shipping instructions (including date), insurance, zone, prepaid or collect, weight, truckline carrier or UPS, fee amount, the total number of cartons making up this order (number "4 of 10," for example), the number of the carton, and where in the shipping zone the carton is to go (such as by sortline, rack slot, and carrier dock). All the information printed on these tickets is retained in the data bases so that any time a particular label's bar code number is transmitted, the computer can match it against specific data pertinent to that section of the order, and that section only.

The continuous forms go through a bursting procedure, and are sent to our customer service department for review of any special handling instructions, expediting, or other required processing.

No inventory adjustment takes place at the time the picking tickets are generated. The quantities allocated are indicated as such in an "allocated" bucket within the "stock master's" data base. During the "end-of-day shipping" processing, at which time the completed order is actually removed from the data base, the "active" inventory is then adjusted for the appropriate number of units shipped, along with the "allocated" inventory adjustment. Also, appropriate audit logs are

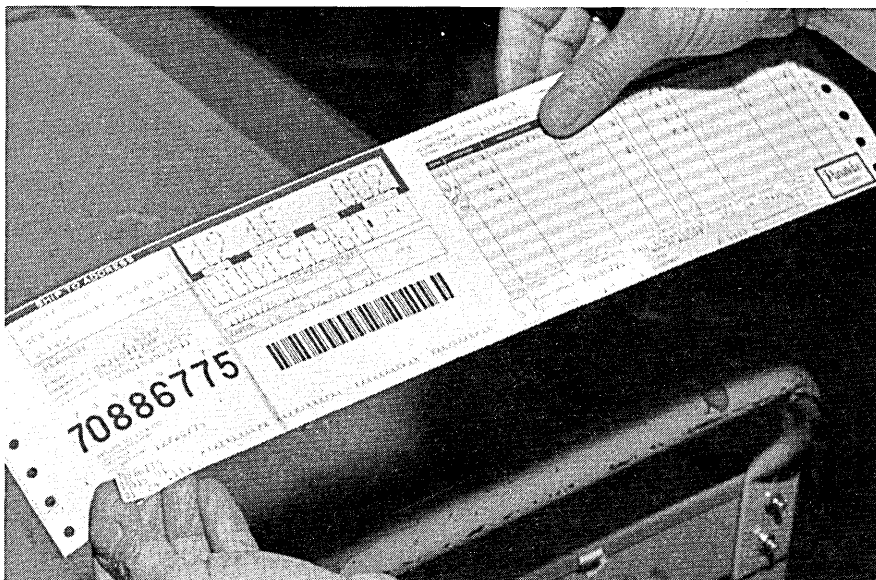

The bar coded shipping label, designed by Standard Register Co. of Dayton, serves as both a picking ticket for order filling (left side), and a packing slip (right side). The order filler is removing an incentive coupon.

generated to reflect the movement and shipment of inventory; these audit logs are processed similarly to the audit logs used for "putaway."

Order filling process

In filling orders, it is possible that a carton will be required to go through more than one zone, and for each zone there is a different person to fill the order. (It is for this reason that several incentive coupons are on the picking ticket.) For each zone, the computer imprints the date, number of units required, and the standard allotted hours (SAH) per unit (this is the amount of time allotted to fill a carton). The order filler removes the relevant coupon and attaches it to a tally sheet which gives a complete record for payroll purposes. (We have plans to automate the data collection of these incentive coupons.)

The packing slip side of the form also provides customer information, but no address. Here are listed the zone, module, section, level, product

code, size, and quantity of each item to be placed in the carton. The size of the carton needed (six sizes are available) is indicated as well, based on the "packing factor."

After the units have been picked, this packing slip portion of the shipping label is placed inside the carton. The next zone for additional filling of the carton is determined by the information printed on the packing slip. The order filler places the carton in a transfer container, manually adjusts the light reflectors to match the next zone, and places the transfer container with the carton inside on the conveyor system.

As the transfer container moves along the conveyor, it passes through

scanning points. The light reflected is used as a command to open or close specific gates, and to keep the carton on track to the next designated zone.

Routing by computer

Throughout the day, orders are completed and shipped from the Little Rock Distribution Center. The computer handles the routing of all cartons over the shipping conveyor systems. As a shipping carton, now automatically taped and sealed, passes the last laser beam scanning check point (for weighing), it is directed either to a specific shipping conveyor line, or to a Shipping Inspection Area (SIA).

Because the picking ticket detail information is available on-line, we have the ability, in addition to a built-in random carton audit and weight check via an on-line transaction, to audit on a percentage basis any particular zone(s) within the warehouse. The carton(s) to be audited, weight checked, or special handled are routed to SIA, where a label is printed on a 3284 on-



**A lot of computers
offer multi-level batch
processing, or RJE,
or realtime, or
interactive timesharing.**

**But only Harris
offers all of it,
concurrently.**

Only Harris delivers multi-use concurrency. Our high performance S100 and S200 packaged systems, combined with our responsive VULCAN operating system delivers simultaneous compute services to each user. As well as simultaneous individual user access to the system.

The S220, shown here, is packaged around the most powerful CPU in the industry. Dozens of benchmarks, including Whetstone, prove the S100/S200 series superior performance. The S220 is one of 6 packaged systems available today, starting at \$85,000. All operate with COBOL, FORTRAN, BASIC, RPG II, FORGO, SNOBOL,

and extended BASIC. And all 6 in the series deliver multiple RJE, multi-level batch processing, multiple interactive timesharing, and real-time processing... all at the same time. If your need is distributed processing, time-sharing, data base management, or any kind of multi-use concurrency, benchmark the S100/S200 packaged systems.

Only Harris gives it all to you, concurrently. Write Harris Computer Systems, 1200 Gateway Drive, Fort Lauderdale, Florida 33309. Europe: Techmation N.V., Gebouw 105/106 Schiphol-Oost, Netherlands.

HARRIS

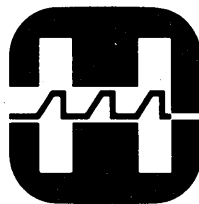

**COMMUNICATIONS AND
INFORMATION HANDLING**

WAREHOUSE

line printer indicating the reason the carton is being routed to this area. The carton is opened in SIA, checked, and an appropriate on-line adjustment made; it is then sent back along the conveyor for retaping and sealing.

Shipping

The shipping data bases are reloaded daily during the batch "order processing" flow, and we have the ability to consolidate new customer orders with existing ones from the same customer. Such order consolidation has reduced shipping costs considerably, and permits printing of only one "bill of lading," which includes all the order numbers consolidated under that particular "shipment" number.

Also, we not only have the ability to ship orders on the same day the picking tickets go on the floor, but we can fill orders ahead of the shipping date, maintain the completed order's location on the data bases, and then just prior to the shipping date requested by the customer, have the system automatically generate "pull sheets" for these orders.

At the time each uniquely bar coded carton is scanned and weighed, if it is

also to be routed UPS, the customer's zip code, actual carton weight, and a UPS rate table are then used to calculate the shipping charges on-line. The carton is then routed down the UPS conveyor sortline, and a UPS manifest entry is generated and printed on a 3284 on-line printer located on the shipping dock.

Uniquely coding each carton within an order has theoretically permitted the entire order (the separate cartons) to be filled simultaneously (parallel picking) within the warehouse. The computer is also responsible for having the order put together on the shipping dock. Therefore, the order fillers themselves do not have to ensure that the order is completed.

Advance information, generated at the same time the picking tickets are generated, informs the shipping foreman how many consolidation racks will be needed, what sortlines will be used that day, and how much space is needed for specific orders.

Because the number of cartons in an order is clearly indicated on each label, the freight handler knows when they are all present. Since the completion information has been collected by the computer, it then prints on a 3286 terminal located on the shipping dock the "bill of lading" for that shipment.

During the "end-of-day shipping" batch flow at night, those orders which have been completed are dropped from the Little Rock data bases, and "audit logs" are generated which are then transmitted to the home office to relieve the "open picking ticket file" and to generate invoices. If for any reason the orders could not be shipped complete, an appropriate on-line adjustment is made in SIA which is reflected by audit logs that are also transmitted to the home office. If the nature of the adjustment is such that a back order is required, the portion of the order that was shipped is billed, and a back order is generated and placed on an "open order" file to be allocated when the inventory becomes available.

Conclusions

The uniquely numbered cartons which are both man and machine readable have provided us with a method to keep track of, and determine the status of, inbound as well as outbound cartons, orders, and shipments. There is, in other words, complete control of all carton movements by the computer at all times. To find out where any one carton is in the process, one has only to go to the nearest terminal and key in the carton number to find out the status of that

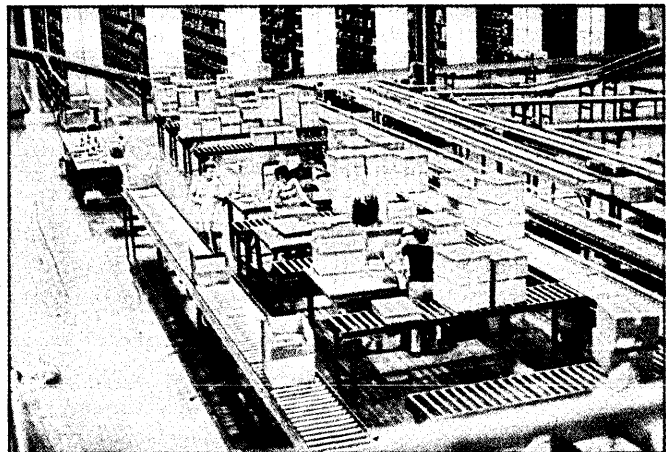
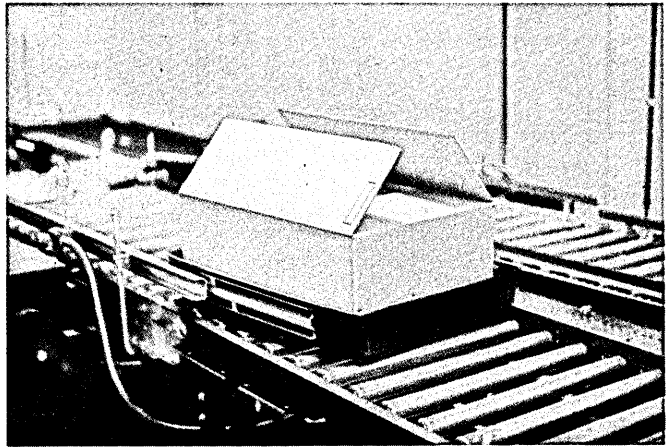

Clockwise: Filling an order; carton in transfer container traversing more than one zone for order filling (light reflectors guide it to proper zones); Shipping Inspection Area for audits, weight

checks, and special handling; consolidation racks in shipping area containing completed orders (a bill of lading is under the top carton of second rack).

STARAN classifies crops over 26 times faster for NASA.

When NASA installed Goodyear's STARAN® associative processor at the Johnson Space Center, their goal was to improve speed and volume of image processing for the LACIE (Large Area Crop Inventory Experiment) program. The challenge was classifying billions of data bits from satellite images to help LACIE personnel determine wheat acreage.

Now STARAN has proven it can do the job over 26 times faster than was ever possible before.

In only 8 minutes, STARAN classifies approximately 7.6 million acres into 10 distinct classes of data. Previously, it had taken conventional computers over 3½ hours to categorize these same images.

By combining content addressability with parallel array arithmetic, a unique capability to process thousands of picture elements at once produces dramatic improvements in image throughput. That's why the STARAN processing system is

unmatched in its ability to solve complex problems involving operations on many similar data streams or high-speed searches of many similar file records.

So before you invest a lot of money in a high data rate digital system, invest a little time to look into STARAN. It works for NASA. It can work for you too.

For complete information, write to Wayne Brubaker, Goodyear Aerospace Corporation, Akron, Ohio 44315. Or call him at (216) 794-3631.

CIRCLE 72 ON READER CARD

GOODYEAR
DIGITAL SYSTEMS

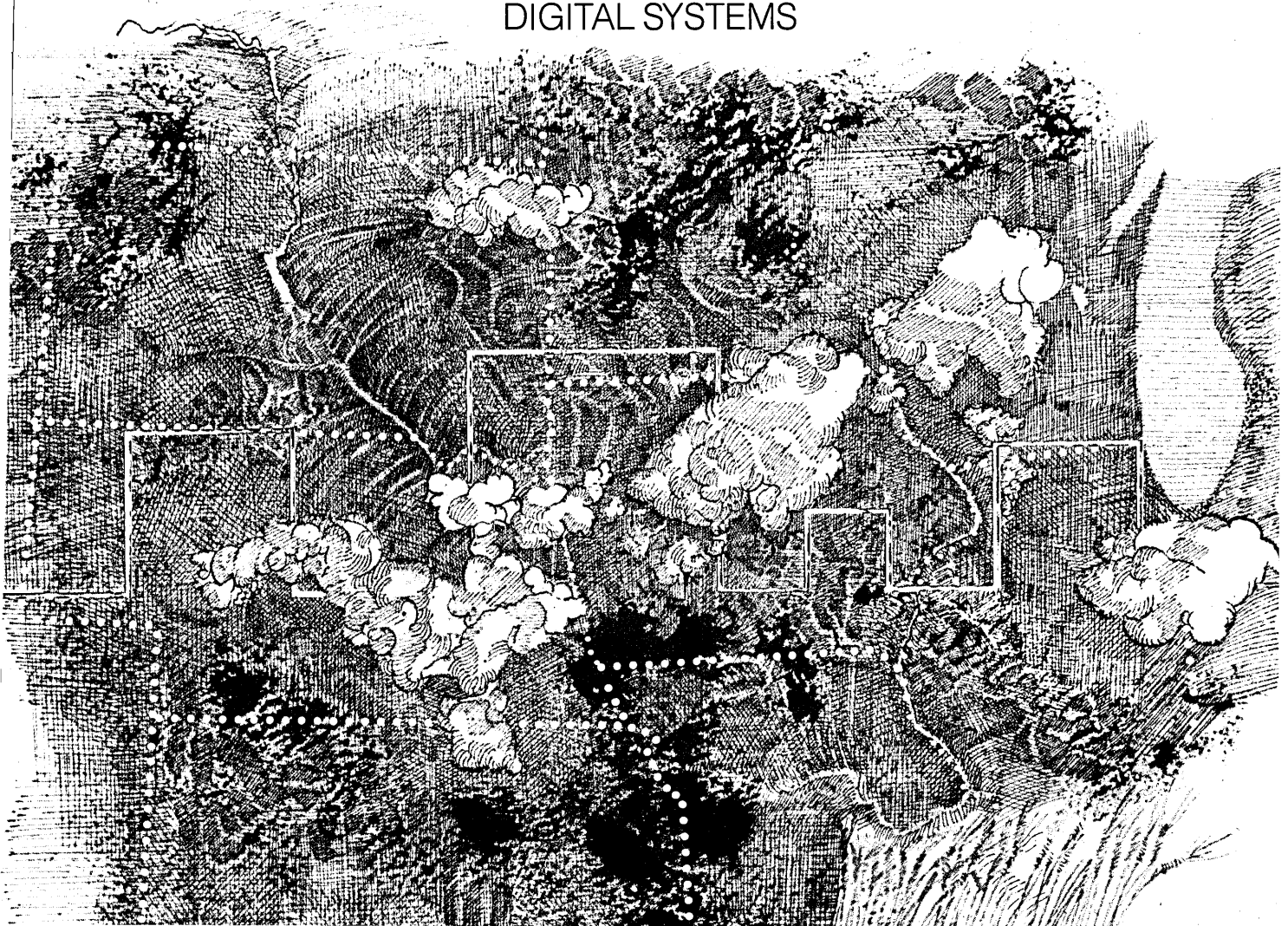

**You're outgrowing
your 3270.**

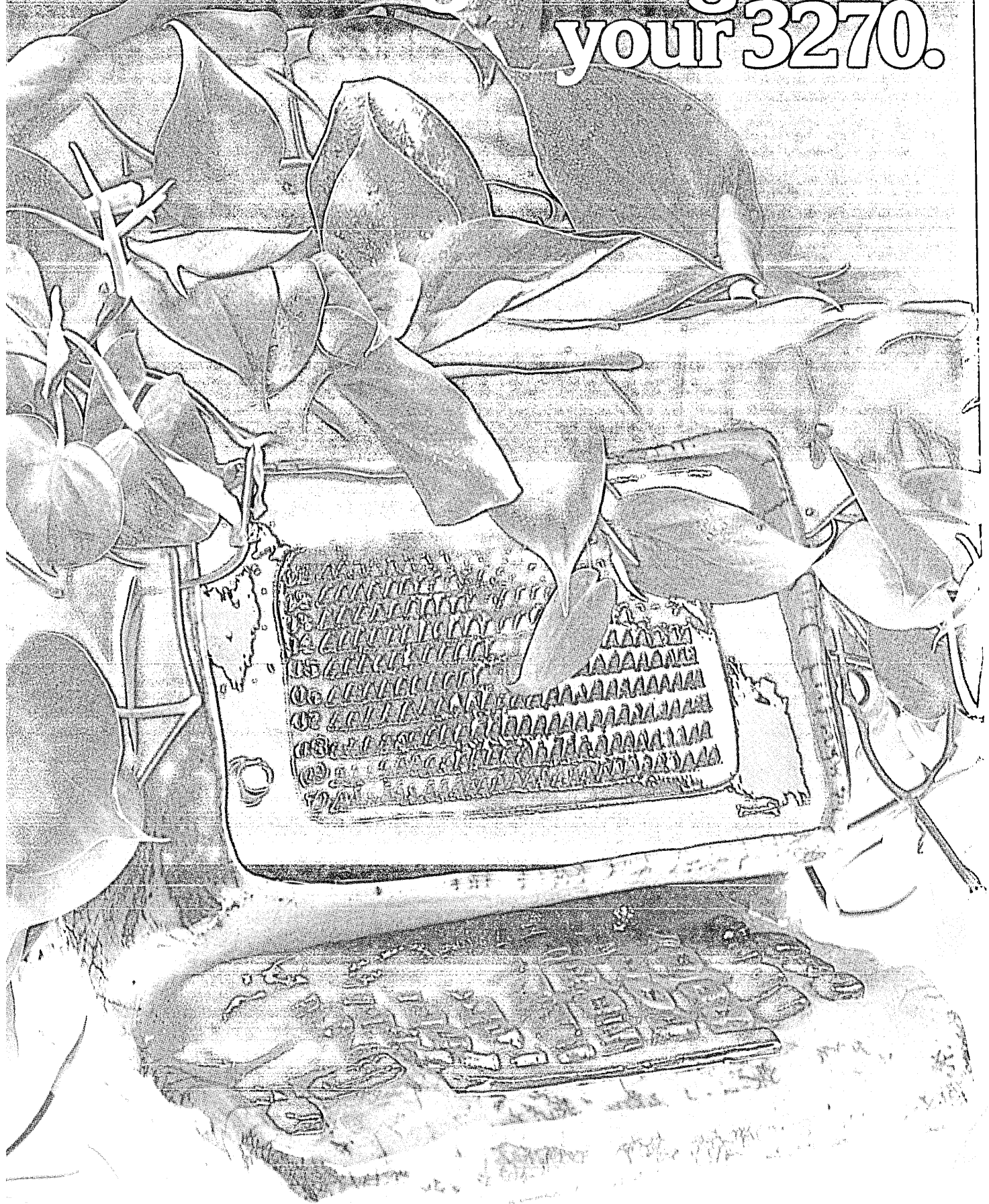

Now what?

Things really bloomed when you first put your 3270 on line.

But now your system's growing like a jungle.

Your phone lines or your mainframe go down...so your 3270 just sits idle.

And when everything is working, your lines jam up and your mainframe bogs down...so your 3270 works a lot more slowly than you'd expect.

Errors keep cropping up, but your 3270 can't weed them out.

And you'd really like to keep a small data base at your terminal for fast access...but your 3270 can't even begin to handle that.

May we suggest a simple and sure solution? Add or replace with the Sanders 8170.

The Sanders 8170 is completely compatible with the 3270. Emulates it 100%, without requiring debugging or new software. Costs less too. And that's just the start.

As you grow, Sanders enhancements keep your 8170 growing with you by distributing the processing...without wiping out your initial software investment.

For example:

When your phone lines are clogged or down, Sanders Queued Transaction Handling stores your data locally until your mainframe becomes available.

Operator errors? Sanders Local Validation and Arithmetics catches errors on the spot. Sanders Local File Reference lets you see names or descriptions whenever you enter an account number.

Need more speed and flexibility? Sanders Local Format Storage speeds up your operation by eliminating the transmission of lengthy formats. Sanders Automated Keystrokes give you multi-key entry from a single key depression. And Sanders Formatted Local Print lets you select, rearrange, and print data without host intervention.

Sanders 8170. The intelligent Answer. Compatible. Lower Priced. Does more because it distributes the processing. And immediately available, so you can replant before you get

 lost in the jungle.

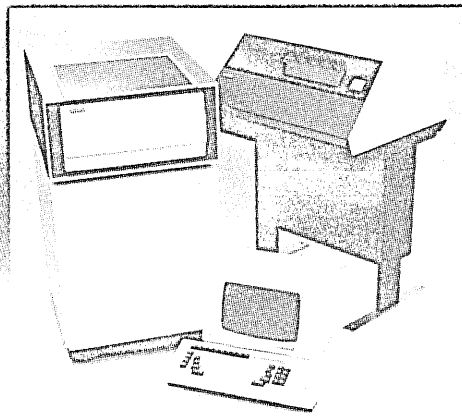

Home Office: Daniel Webster Highway, South Nashua, New Hampshire 03060 (603) 885-6685 • Sales Offices: California (415) 692-2485; (213) 641-4613 • Colorado (303) 771-4380 • Connecticut (203) 246-7289 • Florida (305) 592-7424 • Georgia (404) 451-8815 • Illinois (217) 529-0221; (312) 693-2087 • Louisiana (504) 887-7904 • Massachusetts (617) 889-9061 • Michigan (313) 358-4260 • Minnesota (612) 854-5695 • New Jersey (201) 636-0722; (609) 665-3350 • New York (212) 489-7750 • North Carolina (704) 527-2642 • Ohio (216) 888-7300 • Oklahoma (405) 235-1421 • Pennsylvania (412) 563-3313 • Texas (713) 681-5821; (214) 233-0691 • Virginia (804) 270-0602; (703) 920-5204 • Washington (206) 363-3930 • Wisconsin (414) 543-6240 • International Subsidiaries: Germany 67 80 39 • UK (01) 499-9452; (061) 228-3565 • International Distributors: Australia 888-8111 • Denmark 14.63.04 • Italy 34.44.59 • Japan 543-7611 • New Zealand 664-149 • Venezuela 781-8888

Sanders Data Systems Group, Nashua, N.H. 03060
Help! I've got a growing need
to know more about your 8170.

Name _____ Title _____

Company _____

Street _____ City _____

State _____ Zip _____ Phone _____

CIRCLE 81 ON READER CARD

*Trademark of Sanders Associates, Inc.

THE SUNSHINE STATE OFFERS HIGHER PROFIT POTENTIALS TO ELECTRONIC PRODUCTS MANUFACTURERS THAN ELSEWHERE IN THE COUNTRY!

Florida's substantial labor and operating cost advantages, plus ready access to the markets of the United States, Latin America and the world, combine to offer a unique profit opportunity for a Florida-based manufacturer.

Before you make any decisions regarding your business, this new industry study documenting Florida's position should be reviewed carefully.

To get your copy of *Florida Profit Potentials in Electronic Products Manufacturing*, write or call:

FLORIDA
WE'RE MORE THAN SUNSHINE

Joe Hennessy, Director
Division of Economic Development
Florida Department of Commerce
107 W. Gaines Street, Room 103D
Tallahassee, Florida 32304
(904) 488-5507

CIRCLE 128 ON READER CARD

WAREHOUSE

carton. Or, information that can be displayed can also be used, along with other on-line transactions, to track down the status of orders, shipments, and/or manifests.

The speed and accuracy which this warehouse automation has made possible—all the hardware (except for certain standard items) and the software was developed specifically for this Distribution Center—enables us to both ship and bill any size orders in one day. We can also unload and allocate 2,200 cartons (or two trailerloads) of goods in the same day; of course we can just unload considerably more than that in a day.

But perhaps most important, we now have the most accurate inventory of any Levi Strauss facility ever, which is the real key to filling orders fast. Furthermore, the Little Rock Distribution Center has been built for expansion; it can be doubled in size, and the ability to handle the output of other divisions is available.

Due to the success of this facility, there are plans to modify the Amarillo, Texas, and Florence, Kentucky, Distribution Centers to utilize some of the same system theories on which the Little Rock operation is based.

Further, future plans include installing on-line invoicing, examining the use of portable pen scanners to do physical inventory by hand (since the bar coding of each carton is there), in addition to the increase in our capacity and workload just mentioned.

In brief, we have very successfully controlled and expedited the receipt, storage, and shipment of our fast growing Panatela sportswear line specifically by use of the "bar code technique" in conjunction with sophisticated computer systems. ❁

A real live Datamation Umbrella.

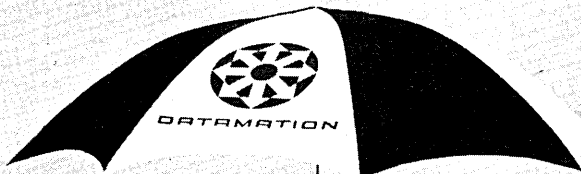

DATAMATION

35 Mason Street
Greenwich CT 06830

Please send me _____ Datamation Umbrella(s) for \$13.95 each plus \$1 for shipping and handling. Enclosed is my check or money order. Offer good in U.S. and Canada.



Name _____
Street _____
City _____
State _____ ZIP _____



Mr. Benson is the data processing manager of Levi's Panatela Division Distribution Center, Little Rock, Ark. He was formerly computer operations manager at the center, and prior to that, project leader for on-line real-time systems at Bobbie Brooks, Inc. of Cleveland.

Four problems in Data Processing Documentation ...and how Wright Line's New Documentation Handling System helps you solve them...



1 The many different sizes and shapes of documentation . . . manuals, computer reports and listings, flow charting and layout forms, punched cards and even magnetic files . . . don't fit properly into conventional office equipment.

3 Reference documentation should be at your fingertips. Existing equipment does not recognize both a filing mode and a reference mode.

2 Various documentation that is used together should be filed together. Even special purpose equipment doesn't allow you to intermix different sizes and shapes.

4 Documentation moves physically from place to place; in systems, programming, operations and user departments. Existing equipment does not provide total compatibility at all locations.

DOCU-MATE™.M.

Documentation Handling System provides the answer to these problems and gives you the tool you need to organize and control your D.P. Documentation System.

With its new center hook hanging concept, Wright Line's documentation handling system provides hanging cartridges for software, hardware and user manuals; hanging cartridges for print-out reports and listings; hanging binders for user output reports and hanging folders and document holders for every size and shape of documentation including cards, microfiche, flow charts, layout forms and project correspondence. And, each device fits interchangeably into all equipment in the



line. You can choose from a wide variety of equipment designed for both filing mode and reference mode use. The line is so complete you can configure work station and library environments to your exact needs from the ground up or add new organization and control by combining elements of this new system with your existing furniture.

Get complete details on this exciting new way to organize and control your Data Processing Documentation System. Circle the readers' service number or write today
Wright Line Incorporated,
160 Gold Star Boulevard,
Worcester, Mass. 01606.



Offices and representatives in principal cities throughout North America

CIRCLE 78 ON READER CARD

990/10 OEM minicomputers.

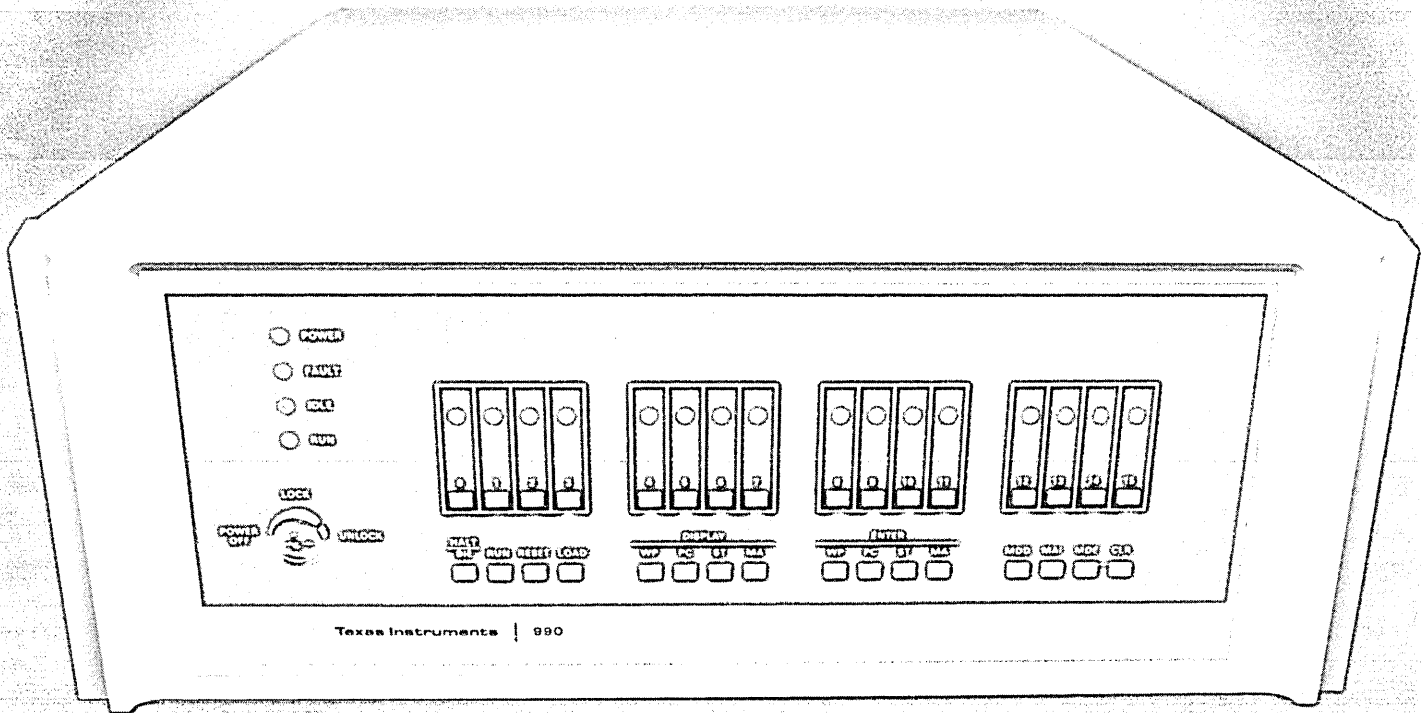

Built, backed and priced to sharpen your competitive edge.

TEXAS INSTRUMENTS.

The 990/10 minicomputer from TI brings superior value to both you and your customers.

Starting with field-proven hardware, the 990/10 delivers the reliability you expect from TI. And all the off-the-shelf support you need for user applications. You get standard software languages, a broad choice of peripherals and nationwide service.

Built for more processing power.

The 990/10 is the most powerful member of the 990 computer family. Its architecture provides features that give you maximum processing power for your money. Like hardware multiply and divide. A 16-level hardware

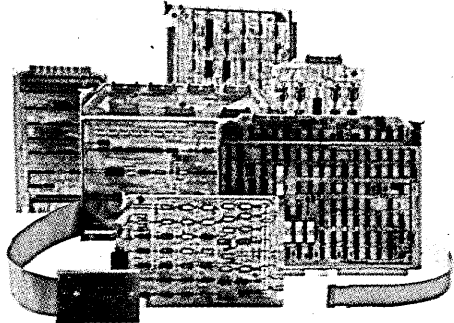

Peripheral Interface Modules

interrupt structure. 16 registers arranged in a workspace concept. I/O that's directly programmable through the Communications Register Unit (CRU) and autonomously through a high-speed data bus. And bit, byte and word addressing of memory.

Built for system flexibility.

In small or large configurations, the 990/10 design provides surprising flexibility for a small investment.

The CRU, with up to 4096 I/O lines, reduces interfacing costs by keeping controller complexity to a minimum. The TILINE* asynchronous high-

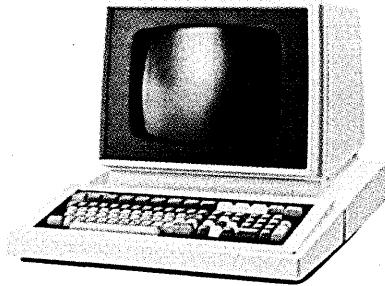

Model 913 Video Display Terminal

speed data bus can support both high- and low-speed devices and takes advantage of design simplicity for simultaneous data transfer between peripherals, the CPU and memory.

With the 990/10, you get a powerful instruction set with an extended operating feature that allows hardware to take over operations that software would normally execute. An optional mapping feature provides memory protection and memory expansion to 1 million words. And, optional error-correcting memory corrects single-bit errors for increased system reliability.

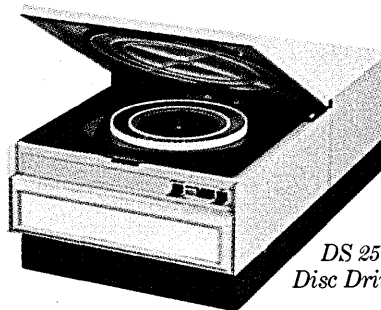

DS 25/50 Disc Drives

Full peripheral support.

As well as a range of standard peripherals, disc storage to 90 million 16-bit words and magnetic tape with 800 and 1600 bpi options are available for low-cost mass storage and back-up.

A choice of software.

With common higher level languages, FORTRAN IV, COBOL and Multiuser BASIC, plus the 990/10 assembly language, you have all the tools you need for an efficient application program.

Both the disc-based and memory resident operating systems give you modularity and flexibility for system generation to meet application de-

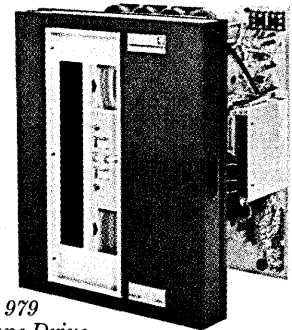

Model 979 Tape Drive

mands. We offer program development aids for creating and testing software, and communications software to support synchronous or asynchronous data transmission.

Backed with nationwide service.

Our responsibility to you doesn't end with the sale. We follow through with complete system training, plus a nationwide factory service network.

The TI 990/10 minicomputer. We build it, back it and price it the way you and your customers want it. You can start configuring a system now with our 990 Computer Systems Handbook on the upward-compatible family of the TMS 9900 microprocessor, 990/4 microcomputer and 990/10 minicomputer. For your free copy, send a letterhead request to Texas Instruments Incorporated P.O. Box 1444, M/S 784, Houston, Texas 77001.



TEXAS INSTRUMENTS

INCORPORATED
CIRCLE 39 ON READER CARD

*Trademark of Texas Instruments.



```

171 009188 PERFORM MOVE-IT THRU HEAD-EXIT.
172 009189 PERFORM MOVE-IT THRU HEAD-EXIT.
173 009190 PERFORM MOVE-IT THRU HEAD-EXIT.
174 009191 PERFORM MOVE-IT THRU HEAD-EXIT.
175 009192 PERFORM MOVE-IT THRU HEAD-EXIT.
176 009193 PERFORM MOVE-IT THRU HEAD-EXIT.
177 009194 PERFORM MOVE-IT THRU HEAD-EXIT.
178 009195 PERFORM MOVE-IT THRU HEAD-EXIT.
179 009200 PERFORM MOVE-IT THRU HEAD-EXIT.
180 010020 PERFORM MOVE-IT THRU HEAD-EXIT.
181 010030 CONT.
182 010040 PERFORM MOVE-IT THRU MOVE-EXIT.
183 010050 PERFORM ADD-DEPT THRU ADD-EXIT.
184 010060 PERFORM RITE-IT THRU RITE-IT-EXIT.
185 010070 GO TO READ-IT.
186 010080 DEPT-LOT.
187 010090 ADD D-OP TO T-OF.
188 010100 ADD D-FT TO T-FT.
189 010110 ADD D-FI TO T-FI.
190 010120 ADD D-ST TO T-ST.
191 010130 ADD D-ND TO T-ND.
192 010140 ADD D-NA TO T-NA.
193 010150 MOVE D-OP TO DT-OP.
194 010160 MOVE D-FT TO DT-FT.
195 010170 MOVE D-FI TO DT-FI.
196 010180 MOVE D-ST TO DT-ST.
197 010190 MOVE D-NA TO DT-NA.
198 010200 MOVE D-NA TO DT-NA.
199 011010 MOVE DEP-LOT1 TO PRE-LIN.
200 011020 WRITE PRE-LIN AFTER POSITIONING 2.
201 011030 MOVE DEP-LOT2 TO PRE-LIN.
202 011040 WRITE PRE-LIN AFTER POSITIONING 1.
203 011050 MOVE DEP-LOT TO B-OP.
204 011060 MOVE DEP-LOT TO B-FI.
205 011070 MOVE DEP-LOT TO B-FI.
206 011080 MOVE DEP-LOT TO B-ST.
207 011090 MOVE DEP-LOT TO B-NA.
208 011100 MOVE DEP-LOT TO B-NA.
209 011110 MOVE DEP-LOT TO B-NA.
210 011120 MOVE DEP-LOT TO B-NA.

```

Only one distributed processing system speaks Cobol. Sycor's.

Now your branch offices can use Cobol, the language of main-computers, with Sycor's 440 and 410 distributed data entry and processing systems.

That means you can do many vital jobs such as report generation, file listings, post data entry editing and file maintenance faster than ever before. Because they're done at the source, instead of on your large, central computer. And Sycor's Cobol capability is available at no extra cost.

With Sycor's Cobol, a subset of ANSI '74 Cobol, you can still have central control by doing all your program development on your host computer. Or test your programs and do compiling on a 440 or 410 in your branch locations.

Flexible Sycor systems increase efficiency.

While Cobol is running as a background task, your data entry operators can be keying multiple applications in the foreground. All on Sycor 440 and 410 systems.

The Sycor 440 is available with 5, 10 or 20 million characters of storage, 64k bytes of memory and up to eight video display terminals for your large regional offices.

A variety of peripheral options helps stretch your data processing dollar, too. Options like five speeds of printers, three magnetic tape drives and a card reader. Plus asynchronous and binary synchronous communications.



Put economical Cobol at smaller branches.

The Model 410 gives you the same big Cobol processing power as the 440 system for your smaller branches, at a stand-alone-terminal price.

For \$516 a month on a three-year lease, the 410 provides 2.5 million characters of disk storage, 40k bytes of memory, a display station, communications and a 60-cps bi-directional printer. And fast, reliable maintenance from one of our 100 nearby service centers in the United States and Canada.

Get the whole story on Sycor and Cobol.

Find out how you can put big-computer power in your branch offices by using Sycor distributed data entry and processing equipment. Send in the reply card or write Ken Wilson, our product manager, Sycor, Inc., Corporate Offices, Ann Arbor, MI 48104. Or call him at (313) 995-1371.

Better yet, call one of our 32 conveniently located sales offices. They're in the Yellow Pages under "Data Processing Equipment."

Sycor puts computer power where the work is.

SYCOR

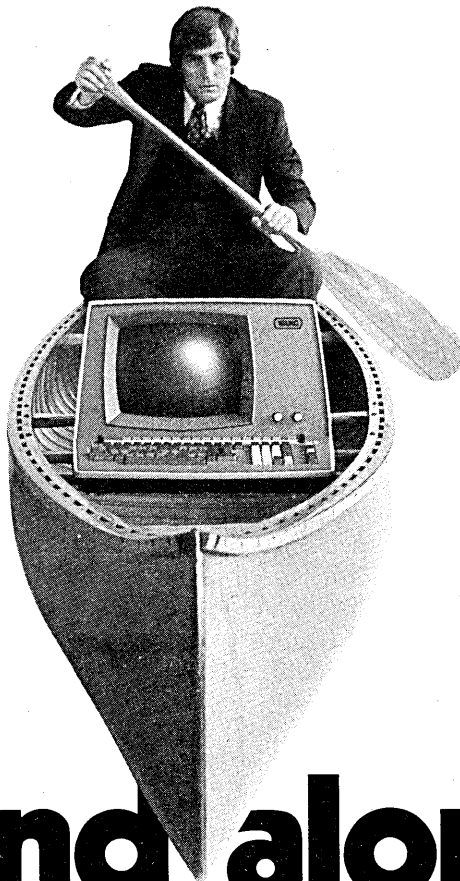

Stand alone or distributed processing, Wang lets you paddle your own canoe.

Up the river with local and corporate data problems? It's time to consider Wang computers. Local operating managements get the data they need to manage their own P&L. Data processing management retains corporate control. And top management loves Wang's equipment and operating costs.

Use a Wang computer as a super-smart intelligent data entry terminal. Enter local data fast. Pre-process and error-check it. With present local staff.

Have as much local file storage as you need. Start with Wang cassette- or diskette-based units. Or fixed/removable disks. Or grow from one to the next as

workloads grow.

Do both headquarters and local work. Remote data entry. Complete order transactions. Invoicing. Sales analyses. The local site can handle many processing/utility jobs that overload high-cost time on the home office computer. Yet have all the local decision-making reports it wants instantly.

If the remote facility is big, add up to 3 Wang work stations. Run up to 4 different jobs simultaneously. Add peripherals as needed. 35 to choose from.

Wang telecommunications options send the data from field to headquarters. Both places work with timely, accurate

information. Each paddles his own canoe. Wang rocks nobody's boat.

For more information, call us. Or write: Wang Laboratories, Inc., Dept. D9, 836 North Street, Tewksbury, MA. 01876, (617) 851-4111.



UCC-6

**NOW, YOU CAN SAY GOODBYE TO
PDS COMPRESSION.**

***CALL 1-(800) 527-3250 AND
FIND OUT WHY.**

*Here's exactly what will happen when you call. One of our staff will take your name and address and immediately send you a brochure explaining exactly what UCC-SIX PDS Space Management is all about. (In Texas, call 214-638-5880 Collect.)

When you've seen how UCC-SIX can solve your PDS compression problems, call this number again. We'll arrange a presentation at your convenience.

UCC-SIX has made PDS compression a thing of the past in almost 50 OS installations because it:

- Automatically inventories and controls PDS disc space.
- Eliminates ABENDS and "dump and restore" operations caused by exhausted PDS disc space.
- Minimizes disc investment.
- Saves programmer and machine time.

UCC

We're going to
be the IBM of software
companies.

CIRCLE 47 ON READER CARD

University Computing Company • P.O. Box 47911 • Dallas, Texas 75247 • A Wyly Company

EXTEL'S NEW 30 CPS PRINTER IS:

- MICROPROCESSOR CONTROLLED.
- MECHANICALLY UNCOMPLICATED. ELECTRONICALLY SOPHISTICATED.
- EVERYTHING YOU NEED IN A 30 CPS OUTPUT (R/O) PRINTER.

OUR 5 x 7 DOT MATRIX CHARACTER-AT-A-TIME IMPACT PRINTING PROVIDES EASY READABILITY. ORIGINAL PLUS TWO COPIES. PROGRAM CONTROL PERMITS ON-LINE TYPE-STYLE CHANGE FOR HEADLINING OR ACCENTING OR EMPHASIZING TEXT:

(UC) UPPER AND (LC) LOWER CASE

(UC) EXPANDED (LC) CHARACTERS

(UC) BOLD FACE (LC) CHARACTERS

TRUE UNDERLINING

STANDARD CHARACTER SETS INCLUDED ARE IN ASCII OR 5 LEVEL CODE. TTS (6 LEVEL) CODE AVAILABLE AT EXTRA COST.

AND AT NO EXTRA COST:

BUILT IN SERVICE DIAGNOSTICS.

ALL STANDARD SPEEDS TO 30 CPS WITH TRUE 30 CPS THROUGH-PUT...

EVEN WITH
REPEATED
"SHORT-LINE"
PRINTING

BECAUSE
FILL CHARACTERS
ARE
NORMALLY
NOT
REQUIRED!

STANDARD LINE INTERFACES: EIA RS 232C. DC LOOP. MIL 188C.

THESE ADDED SMALL-COST OPTIONS
MAKE THIS OUTSTANDING PRINTER A
SELF-STANDING R/O TERMINAL:

BUILT-IN MODEMS WITH 103 OR 108 OR 113 COMPATABILITY.

SELECTIVE CALLING - FOR MOST WIDELY USED 5/6/8 LEVEL
PROCEDURES.

A 20 CHARACTER ANSWER BACK.

PAGE FORMATTING - 8-1/2" x 11" FORMAT FROM PLAIN PAPER
FOR CONVENIENCE IN FILING.

NATIONAL OR SPECIAL CHARACTER SETS - INCLUDING LOWER
CASE DESCENDERS.

IN A COMPACT, COMPLETELY SELF-CONTAINED UNIT - 12-5/8" WIDE,
17-3/8" DEEP, AND 5" HIGH (WITHOUT PAPER ROLL); 25 LBS.

CALL OR WRITE FOR BROCHURE

The quiet, uncomplicated,
multi-copy teleprinter
—over 35,000 in worldwide
use. Sales and service
in 80 countries.



CIRCLE 31 ON READER CARD

EXTEL CORPORATION
310 Anthony Trail
Northbrook, IL 60062
(312) 564-2600
Telex: 72-4398



NO MORE SHOCKS. PERIOD!

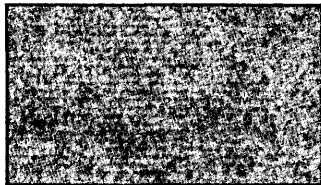

Cranberry Red

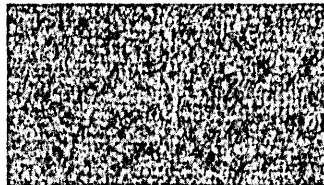

Jungle Green

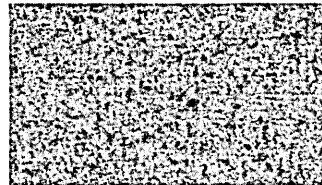

Aztec Gold

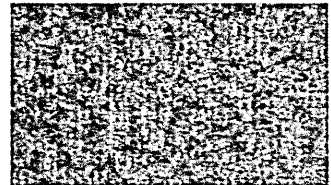

Brownstone

Crown's *Stat-Zap* mats and matting.

Now, someone has finally come up with a true anti-static mat and matting product. Proven in test after test to reduce the level of static charges below the 3000-volt level...the shock cut-off point for most people. The first carpet-top, vinyl-back, anti-static mats and matting ever offered. And they're made only by Crown. Stat-Zap mats and matting. No more shocks. No more sparks. No more equipment malfunctions caused by electro-static build-up. Fulfilling a real need in many applications. Wide choice, too: 8 mat sizes, 3 rolled matting widths, 4 decorator colors... all with a full 5-year limited wear warranty. Send for more information. And learn how you can stop static shocks.

Please send me more information about your Stat-Zap mats and matting.

NAME _____

TITLE _____ COMPANY _____

ADDRESS _____ PHONE _____

CITY _____ STATE _____ ZIP _____

Crown Industries

1615 Croghan Street • Fremont, Ohio 43420

A DIVISION OF

Ludlow

CORPORATION

#76-4U

Fragments of Computer History

by Edward K. Yasaki, Sr. Associate Editor

Data processing historians and historic data processors met to begin piecing together the computer's past, and ended up with a collection of pieces—What was that still-secret British machine? Whose idea was the stored program computer? Was the Whirlwind a mini done larger?

A gathering of very prominent industry pioneers convened in July at the Los Alamos Scientific Laboratory in New Mexico. Under National Science Foundation sponsorship, the International Research Conference on the History of Computing provided a showcase of speakers from around the world: Konrad Zuse on his prewar computers in Germany, Edsger Dijkstra on software, Ryota Suekane on Japanese relay computers, Calvin Gotlieb on early Canadiana, Julian Bigelow on Princeton's IAS (Institute for Advanced Study) computer, John Backus on software, and Harry Huskey on SWAC, among them. Heinz Zemanek gave a charming presentation on the prehistory of computing—people and devices—in Central Europe. Alas, none of the Russian speakers showed up.

The conference chairmen, LASL's Nick Metropolis and Jack Worlton, warned that this was to be a working conference, not a reunion. And for the casual attendee it was sort of like walking into a theatre in the middle of a picture. The papers presented and the modicum of discussions that ensued not only offered mere fragmentary episodes of the past but also presumed that the listener was a mathematician or engineer of that era, fully versed on the cast of characters, the machines they developed, and the significant features of those early computers. Many of them, of course, were of that caliber. They were even in a position to nod their heads knowingly when someone mentioned problems encountered with a certain vacuum tube.

Who was on first?

The conference, however, made it clear that a number of early developments took place simultaneously, sometimes without the knowledge by one party of another's parallel effort. But at the same time there was also a lot of beneficial interaction among the pioneers, stemming from a policy of open disclosure and discussion. People have always tended to congregate where new things were going on: the Moore School of Electrical Engineer-

ing at the Univ. of Pennsylvania and Princeton's IAS were frequently mentioned, as were the U.K.'s Manchester and Cambridge Universities and the National Physics Lab. And some people, such as John von Neumann, seemed to have got around more than others. Thus it is often impossible to determine whose work influenced whom or by how much.

Brian Randell of the Univ. of Newcastle Upon Tyne phrased it most succinctly. He said, "In all probability, where the need is similar and people are of equivalent caliber, you're going to find a lot of parallel inventions. That is no credit or discredit to anybody. What we are finding out here all week is that there are a lot of parallel inventions and a lot of useful interaction."

In a gathering of this sort, therefore, it was not surprising to hear someone explain, for example, that before the Williams tube was first built in the U.K., the idea for such a storage device was being bandied about in the U.S. It was talked about also in the U.K. before F. C. Williams produced the first working example at Manchester Univ. (People refer to him as Freddie Williams, much as von Neumann's contemporaries call him Johnnie.)

It's still not clear who was first to come up with the concept of storing a program in the computer. In the minds of many people, credit for that goes solely to von Neumann, for he mentioned this idea in a draft paper on the EDVAC, dated June 1945. But it should now be clear that, while von Neumann played a significant role in implementing this concept in the EDVAC, the concept itself arose before his participation in this project.

Heading the project were J. Presper Eckert and John Mauchly, the same team that brought us the ENIAC earlier. Eckert failed to show up for the Los Alamos conference, but Mauchly was given time to read a paper by his former partner. He spoke of a document (he referred to it as a disclosure) dated January 1944 in which Eckert expressed the idea of storing instructions in a computer. It apparently is

one of many documents found by lawyers combing through old files in preparation for a trial.

"It is a strange fact that after this was written down by Eckert, it sort of got lost," Mauchly said. "Nobody seemed to remember it anymore." He added that he spoke to Harry Huskey at the conference and asked whether Huskey, when he arrived at the Moore School in the spring of '44, had heard about the concept of storing instructions in some kind of computer memory. He said Huskey's reply was, "Why yes, Eckert told me about that and my immediate reaction was, 'Why didn't I think of that?'"

Mauchly said the concept was discussed among those on the ENIAC project before von Neumann first visited them the following September. The thing that kept them from implementing it earlier, he added, was the lack of low-cost storage with adequate speed. Former IBMer Cuthbert Hurd said he spent much time with von Neumann, who was a consultant to IBM for one month a year. "I never heard him make the claim that he invented stored programming," Hurd said.

It's possible that a simultaneous or even earlier development exists and is yet to be uncovered. This was illustrated by a presentation on a programmable, electronic digital computer built in Great Britain during World War II and called the Colossus. Brian Randell said it was not a general purpose computer but rather one developed for secret wartime use, such as deciphering the German code. Only a limited amount of information on the still-secret project and the electronic machines was disclosed in October 1975 by the British government.

Randell said Alan Turing was not directly involved in the Colossus, but indications are that the design was influenced by Turing's earlier work on the computability of numbers. More than one Colossus was made, no two of which were exactly alike. A reference to them is said to appear in F. W. Winterbotham's book, "The Ultra Secret," (Dell Publ., New York).

Burroughs users! Now you can eliminate your Achilles heel.

Would a large international bank and thousands of other commercial operations throughout the world use Burroughs computers unless they were very good? Obviously not.

But would the same large international bank, a large bank service company and many other commercial operations substitute IBM-1403's for their Burroughs printers, unless they felt they could improve their printing reliability?

Are quality and reliability of printing your Achilles heel?

If so, we have a simple solution. Adapt an IBM-1403 model -2, -3 or -N1 to your Burroughs system with our Grumman printer controller. The proven quality, speed and reliability of the IBM-1403's should dramatically improve the performance of your printing operations.

Your cost will be nominal. One Burroughs user says he can pay for our printer controller with the savings on ribbons alone. In any case, if you've been paying for extra printing capacity to solve reliability problems, you'll be more than happy with the IBM-1403.

Of course, printing quality and total output are not just Burroughs problems. We are delivering our printer controller to users of CDC, DEC, Univac, Xerox and other computers to solve similar problems. Commercial, educational, scientific, military and computer service bureaus are among our printer controller users.

For multi-vendor installations we can add a switch to your controller to allow you to connect the IBM-1403 to either of two different computers.

You can rent, lease or buy both the printer and controller. For full information, call or write Joe McDonough, Grumman Data Systems Corporation, 45 Crossways Park Drive, Woodbury, New York 11797. (516) 575-3034. Telex: 961 430.

GRUMMAN

GDS 3/76
Printed in USA

Grumman Data Systems

Products and services that lower the cost of computing.

In Canada: Digital Interfaces Ltd., 4800 Dundas St. West, Islington, Ontario M9A 1B1
In Germany: Institut Für Angewandte Elektronik, Zentrale Verwaltung, D 2072 Bargteheide, Am Bargfeld 17, Germany



Now small users can have the big benefits of in-house computer output microfilm.

AutoCOM

You probably thought it took a huge volume to justify your own in-house computer output microfilm system. Well, it did. Until DatagraphiX introduced AutoCOM, the fully automated computer information management system designed expressly for the volume—and budgets—of smaller users.

Set up and ready to go in one day, AutoCOM hardware can be used by just about anyone. And it's compatible with data tapes from virtually any computer.

The self-contained recorder and film processor converts tapes into cut, dry microfiche at the touch of a button. The companion AutoFICHE Duplicator copies the masters at the rate of up

to 450 per hour. And you get the superb reproduction and reliability that's made DatagraphiX the leading name in COM for three decades.

So if you're going outside for microfiche, compare the big benefits of an in-house AutoCOM system. It's quick, confidential and convenient. And if you're not yet using COM, the outstanding price/performance ratio of AutoCOM means it can pay for itself in what you'll save on paper, time and storage.

Use the coupon to get all the details. You don't have to be a big user to get the big benefits of your own in-house AutoCOM.

Stromberg DatagraphiX, Inc.;
P.O. Box 82449: Dept.-D
San Diego, CA 92138;
Phone (714) 291-9960

*Please send me details on in-house
COM with AutoCOM*

Name _____
Company _____
Address _____
City _____ State _____
Zip _____ Phone _____

DatagraphiX®

□ A General Dynamics Subsidiary

COMPUTER HISTORY

Robert Everett, now president of Mitre Corp., showed an admirable attitude toward the who-was-first question. In the absence of Jay Forrester, he spoke about the Whirlwind project at MIT. Everett traced briefly the initial interest in designing a real-time aircraft simulator that was to become, instead, a general purpose computer for real-time applications. The parallel machine went on to become part of the nation's air defense system. But when John Mauchly stood up to say that the BINAC was possibly the first real-time computer, not Whirlwind as Everett had said, the speaker calmly commented, "Well, there's enough glory for everyone."

Two conference attendees, one from the U.K. and one from the U.S., commented over dinner that the meeting will provide official recognition to Konrad Zuse for his little-publicized prewar work in digital computers. An article about the Zuse Z3 and subsequent machines appeared in these pages (September 1966, p. 30) and the German pioneer was also the co-recipient of the 1965 Harry Goode Memorial Award, presented by the American Federation of Information Processing Societies (AFIPS) at the '65 Fall Joint Computer Conference in Las Vegas. But his work in hardware before the war and in software subsequently seems to get short shrift in the literature.

A number of attendees also remarked pointedly that this was the first time they had attended a conference without missing a single session. Indeed attendance at the sessions seemed to grow each day, being comprised of those who arrived late and an increasing number of LASL personnel. Total attendance at the 4½-day conference was on the order of 150.

Whirlwind: first mini?

Readers of history who harbor suspicions that developments did not always unfold as smoothly as the reader is led to believe would have enjoyed Bob Everett's presentation. He was one of several speakers who mentioned the need for computer builders to also build the test instruments. And one often found the workers spending more time developing the test gear than working on the computer. Everett said he could not specify a date when the Whirlwind started to work. "It sort of worked gradually, more and more." (He noted that the whole thing was working in 1951.)

Maurice Wilkes of Cambridge Univ. was more specific. The designer of the EDSAC at Cambridge, graciously giving

much credit to the people at the Moore School for his initial immersion in the ENIAC and in digital computers in general, said the EDSAC first ran in May of 1949. The first programs were for a table of squares and prime numbers. A home-made movie of their accomplishment was shown at the 1951 Joint Computer Conference in Philadelphia. He said it was good getting back to the city "where I had learned so much" to show what progress they had made at Cambridge.

Everett also said that everyone in those early days came up with a different design and tended to do things in their own way. People knew what everyone else was doing, he added, and they would have bought anything already made by someone else "if we could trust them. But we never trusted anyone, and they didn't trust us."

Kenneth Olsen, president of Digital Equipment Corp. and a Whirlwind



Data processing history buffs and pioneers collected from all parts of the world to attend. Here, Dr. Jan A. Rajchman (RCA Labs, Princeton) and Erwin Tomash (chairman of Dataproducts Corp., Woodland Hills, Calif.) listen to Prof. A van Wijngaarden (Stricting Mathematisch Centrum, Amsterdam).

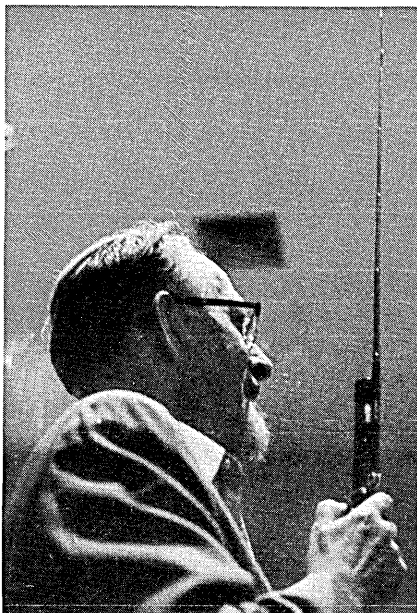

John Mauchly, here shown using a wireless mike from the audience, again made the claim that it was his partner on the ENIAC project, J. Presper Eckert, whom historians ought to credit with the concept for stored program computers.

alumnus, was instrumental in getting the Whirlwind to its present site, the Smithsonian. Everett said that Olsen considers Whirlwind the world's first minicomputer. It's actually a very large machine, Everett explained, but in intent (real-time control) and architecture it's like a mini.

The Manchester machines

Early developments at Manchester Univ. were described by S. H. Lavington. He told of the arrival in late 1946 of Freddie Williams and Tom Kilburn and the first patent application for Williams tube electrostatic storage in December of that year. Their contribution, Lavington said, was in Williams' demonstration that the device works, that the device provided random access storage, and that the crt was a device widely available around the world.

At Manchester, too, arose the idea

PIONEERS, FILE THAT CLAIM!

History buffs will be pleased to learn that the entire history conference was videotaped, and plans were to produce a printed proceedings, as well. No one would venture to say when that would be completed. There were more than 30 speakers, too many to report on in these pages.

But a move is afoot to begin publication of an annals of the history of computing and information processing. The proposed publication, to be issued four times a year but at possibly irregular intervals, seeks to bring together professional historians and computer people. Its purpose "is to encourage and stimulate the preservation of the history of computing, to make information on the heritage of the computing and information processing field available for scholarly and educational purposes, and to provide a forum in which both computer people and historians can interact in the development and communication of historical perspectives." Information on it is available from AFIPS.

During the conference, however, Louis Fein came out with another proposal: The establishment of some means by which people will be able to register their claims to being first with original ideas, theories, and concepts in computers, computing, and closely related fields. Fein (1670 Edgewood Dr., Palo Alto, CA 94303) wants to hear from those who both favor and oppose his proposal for an "international court of public recognition." *

of address generation and storage management. "Historically the interest in this area came about because of the hardware development associated with the Williams tube," he said, "and, later on, (we worked on) the problems of a two-level store—the Williams tube being the first level and the drum the backing store—and the problems of relocation involved. That led to the concept of the B-line, which was later developed into the idea of what we now know as the index register."

Nat Rochester of IBM said the two major contributions of Manchester were the B-line (index) registers and the Williams tube. Wilkes said that Williams' major contribution was his insight into the ability to store in one sweep across the face of the crt and to read on the next.

Some firsts were also claimed for the SEAC (National Bureau of Standards

Eastern Automatic Computer—there was also the SWAC, the western version), which was demonstrated in April 1950 and went operational the following month. Ralph Slutz of NOAA, formerly the weather bureau, said the machine had 750 vacuum tubes and some 10,000 diodes. "All the logic in the system was done by germanium diodes," he noted. "This, as I understand it, makes it the first computer to do all its logic in solid state." He said the vacuum tubes did nothing but amplify; all clocking, gating, and logical operations were carried out by the diodes. But they had more trouble from bad solder joints than they ever had from the tubes, diodes, or delay lines.

Slutz said he had thought SEAC was the first computer to support a remote terminal. This was a Teletype located elsewhere on the NBS grounds during a

demonstration only a couple of months after the system went on the air. "But here at the meeting," he said, "I've heard that George Stibbitz had put a remote terminal on a relay computer long before we did." But he said it was possibly the first with a crt graphical output.

Not to be outdone, Louis Fein managed to get a few minutes on the program to describe the RAYDAC, which he engineered for Raytheon and completed in 1952. It is mentioned here primarily because so little about it has appeared in the literature. It was the first Freon-cooled machine and the first to use plastic-based magnetic tape, this at a time when the Univac I was using steel tape. The RAYDAC had four tapes, all completely buffered. It purportedly was also the first completely checked machine; it had transfer checking, arithmetic checking, and selection checking. And the machine, with 5,200 tubes, operated at 3.77 megacycles, versus the Univac I's 2.25 mc.

As might be expected, historical tales and anecdotal incidents were legion at the conference. A rich source of such stories would be Henry Tropp of Humboldt State Univ. in California, who was with the now-defunct AFIPS-Smithsonian computer history project. Tropp, who joined the project in the spring of 1971, interviewed a number of people—the tapes of which are now ensconced at the Smithsonian.

He told of conversations with George Stibbitz on the genesis of his relay computers. In the pre-1940 era, Stibbitz got the design to where it would work and went to his bosses at Bell Labs. He told them that for \$50,000 he thought he could build a general purpose relay calculator. Their response was, "Who wants to spend \$50,000 just to do calculations?" *

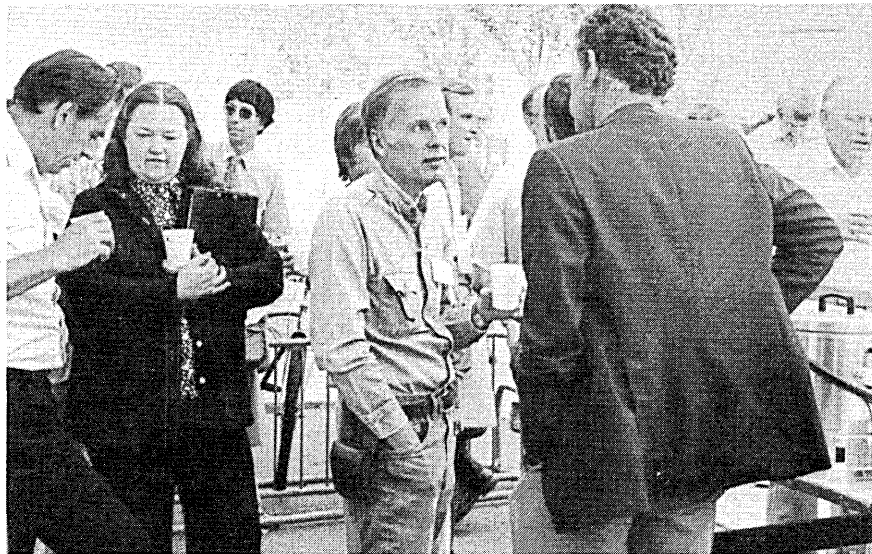

Conversations ran nonstop, with nearly as much information being disseminated between or after formal sessions. John Backus, center, one of the principal developers of Fortran, was found deep in a discussion with Philippe Dreyfus, who spoke on the history of computing in France.

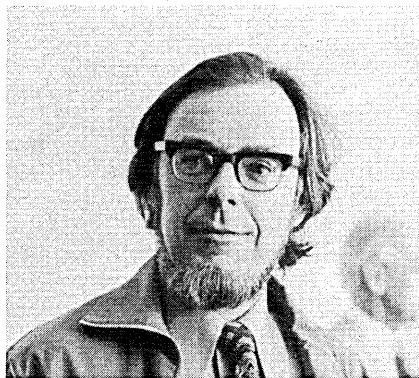

Was there a working digital computer before the ENIAC? Brian Randell, author of "The Origins of Digital Computers—Selected Papers," suggests that the secret British wartime computer, the Colossus, predated the ENIAC but was not a general purpose machine—it was built for such functions as deciphering German code.

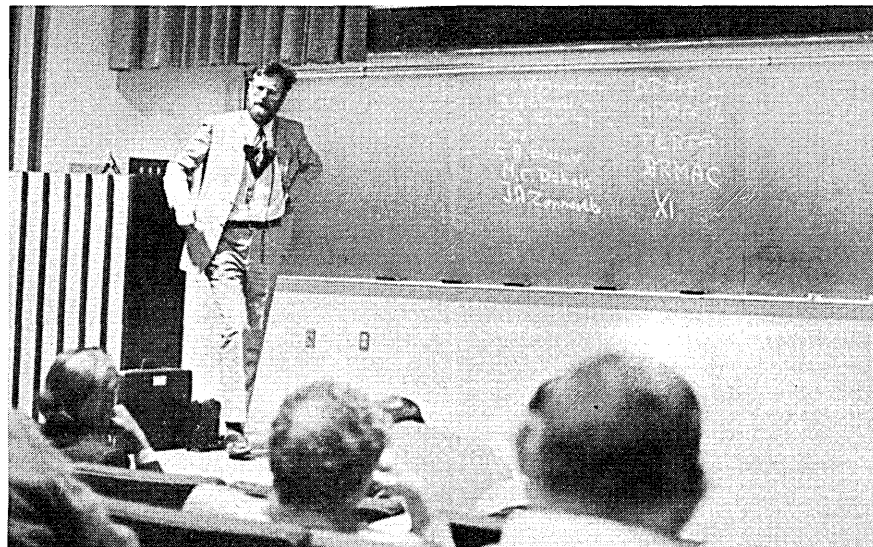

The conference was unusual in that no one skipped sessions. In fact, attendance gradually grew through the 4½-day period. Here Edsger Dijkstra has the podium.

Share a week of stimulating information interchange with the world's best thinkers

IFIP CONGRESS 77 and its Exhibition will mark the first return to North America in more than 12 years for this triennial gathering of information scientists. In sponsoring this important congress, the International Federation for Information Processing (IFIP) brings together developers and users of information processing techniques and technology from 35 member countries throughout the world. In the U.S., IFIP is represented by the American Federation of Information Processing Societies (AFIPS).

REGISTER EARLY AND SAVE

By registering early, you can save up to 30% on the full IFIP Congress registration fee. Early registration fee is \$110. Later registration fees will increase up to \$145, as time progresses.

Past congresses in Paris, Munich, N.Y., Edinburgh, Ljubljana and Stockholm have been major occasions for professional and social interchange among information processing people. The Toronto setting, along with the many special events planned, will make IFIP Congress 77 a chance for a family vacation as well.

To register, or for more information about registration, contact Mr. Robert Spieker, U.S. Chairman, Registration and Accommodations, Western Electric Company, 222 Broadway, New York, NY 10038.

EIGHT REWARDING PROGRAMS

The theme of the week-long Congress, "The maturing profession—perspectives and prospects," will be carried out in eight stimulating program areas, designed to provide participants with insight and understanding of current methods, concepts and trends.

1. Theoretical Foundations of Information Processing—A formalization of concepts, and a discussion of mathematical theory.
2. Computer Hardware—Developments in technology and their influence on computer system design.
3. Computer Software—Programs and procedures which facilitate the development, operation and evolution of application systems.
4. Computer Networks—Aspects of the merger of computer and telecommunications technologies.
5. Applications in Science and Engineering—Mathematical computation and the computational aspects of cybernetics and process control.
6. Computer Aided Design—The application of information processing and computer technology in design.
7. Applications in Management and Administration—Implications of recent advances for organization and administration of information processing areas.
8. Information Processing and Education—Meeting education needs in science and industry.

CALL FOR PAPERS

Papers are currently being solicited which will relate the Congress theme to broad areas of information processing. All papers should deal with the design or use of computer systems, but may concern theoretical advances, new techniques, or practical experiences. In addition the following guidelines must be observed: 1. Papers must be written in English. 2. Total length must not exceed 4,000 words. 3. Four copies of each paper must be submitted. 4. Papers must be received no later than 15 November 1976.

For a copy of the official "Call for Papers" brochure, with complete information on where to submit papers for each program area, write: The U.S. Committee for IFIP Congress 77, c/o The Bowery Savings Bank, 110 E. 42nd Street, New York, NY 10017.

For a pamphlet giving guidelines on preparation of papers, "Instructions and Aids for IFIP 77 Authors", write to Program Committee for IFIP Congress 77, IFIP Foundation, Paulus Potterstraat 40, Amsterdam 1007, Netherlands.

OPPORTUNITY FOR EXHIBITORS

Your organization can benefit from exhibiting its products and services in the week-long IFIP exhibition. The exhibition will parallel the IFIP Congress' technical meetings and is expected to attract more than 10,000 attendees, with a major representation of North American buyers. This is an exciting opportunity to present your newest and most outstanding product lines to an audience which will include new buyers and sophisticated professionals from every area of information processing.

Space is limited, and U.S. companies wishing to exhibit are urged to immediately contact Mr. Gerard Chiffrieller, AFIPS Conference Coordinator, AFIPS Headquarters, 210 Summit Avenue, Montvale, NJ 07645.

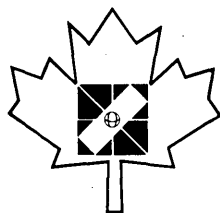

August 8-12, 1977
Toronto Canada

IFIP CONGRESS 77

International Federation for Information Processing
U.S. COMMITTEE FOR IFIP CONGRESS 77
c/o The Bowery Savings Bank, 110 East 42nd Street, New York, N.Y. 10017

The Genie.

The Codex Multipoint Network Control System, MINICS, Areal Genie that can put you in total control of your high speed multipoint network.

Wish for remote monitoring... You've got it. Wish for complete diagnosis of a system problem... You've got it. Wish for restoration of a function so that you are assured of continuous system operation... It's yours. And you control it all from the central location with no human intervention at the remote site required.

Or you can use the MINICS Areal Genie to monitor and control your multipoint network.

Multipoint Modems

Codex Multipoint Modems are available in a variety of configurations. They are available in 1200, 2400, 4800, 7200, or 9600 bps speeds. They are available in 1200, 2400, 4800, 7200, or 9600 bps speeds. They are available in 1200, 2400, 4800, 7200, or 9600 bps speeds.

the high bandwidth data throughput of a 4800 bps modem. And they offer proven reliability, performance, and economy because they include the latest advances in MOS/LSI technology.

On the outbound side the LSI 48FP, LSI 72FP, or LSI 96FP offer 4800, 7200, or 9600 bps speeds respectively

to provide the maximum in a completely automatic operating performance in dedicated multipoint configurations.

So order the Codex Genie to make you the master of your multipoint network and the Fast-Pol slaves will grant you every wish.

codex
We'll get you through.

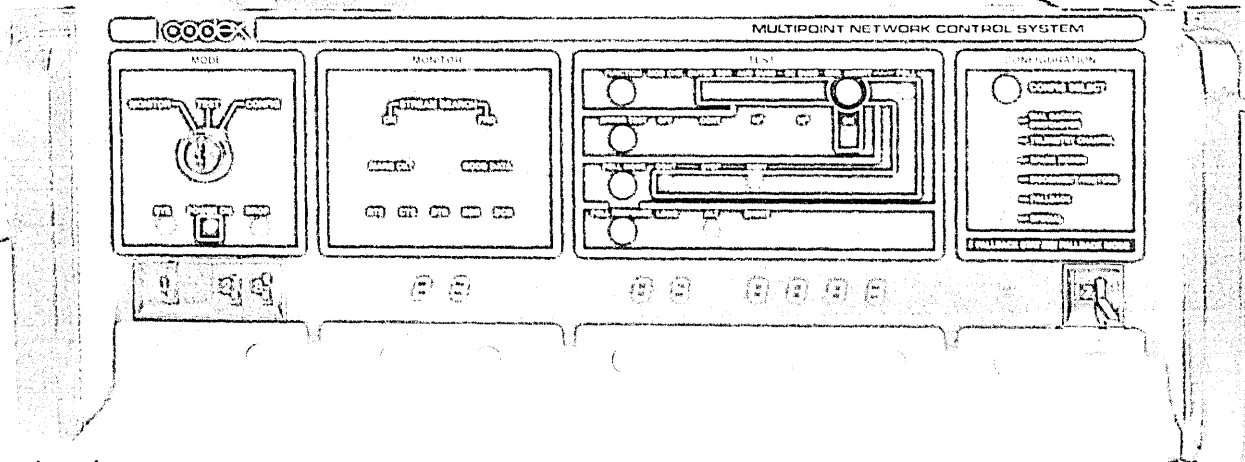
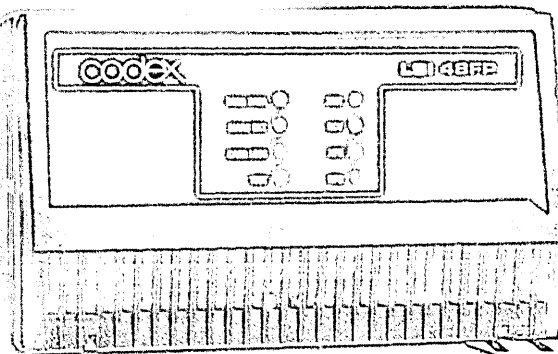
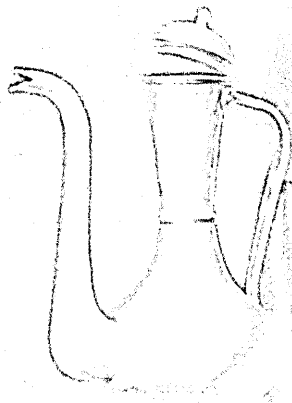

member of
IDCMA

Codex Corporation, 15 Riverdale Avenue, Newton, Massachusetts 02459 Tel: (617) 969-0600 Telex: 92-2443 Codex Europe S.A., Bte 7, Av. de Tervuren 412, B-1150 Brussels, Belgium Tel: 762.23.51 762.24.21 Telex: 26542. Offices and distributors in major cities throughout the world.

CIRCLE 7 ON READER CARD

Patent Pending

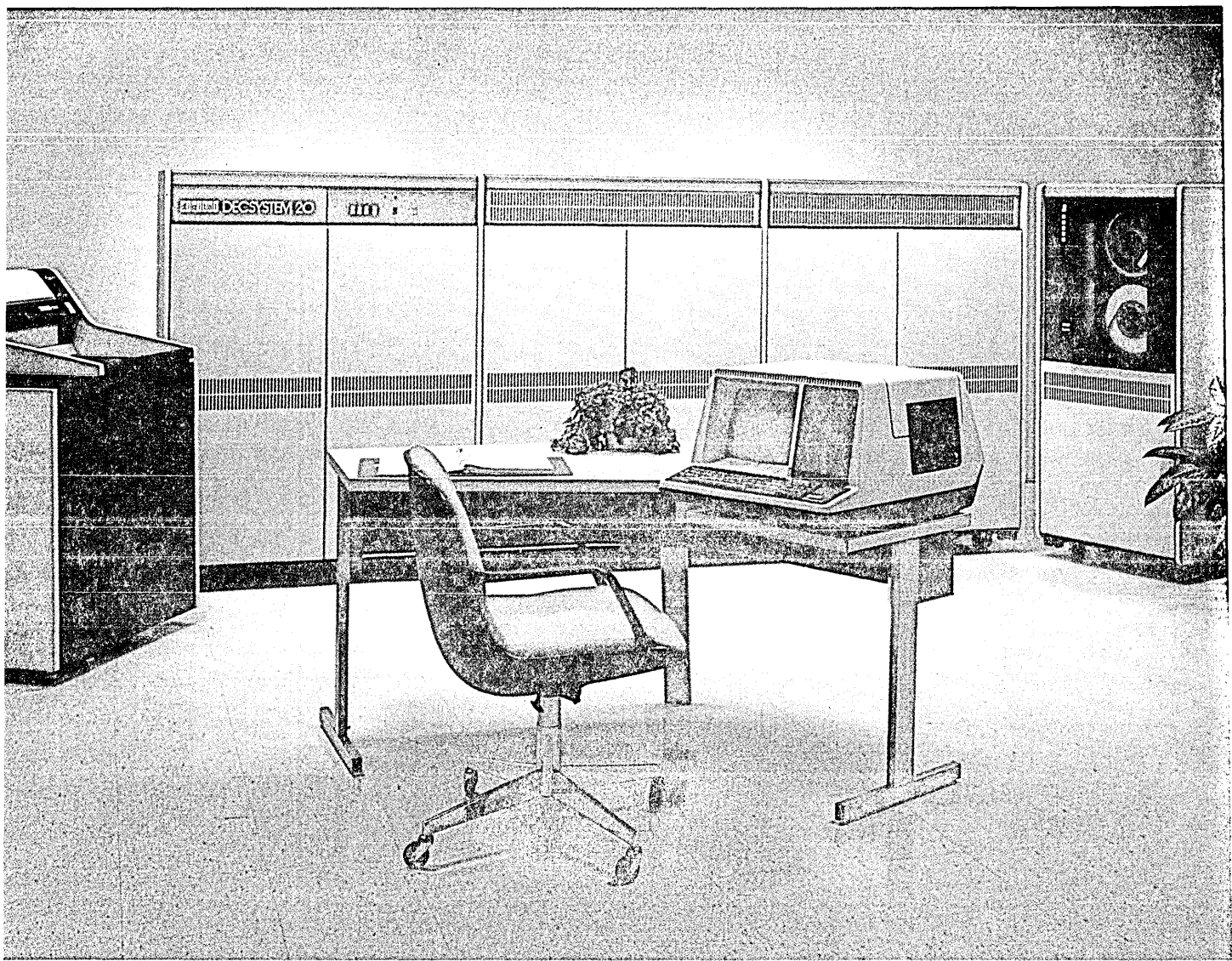

DECSYSTEM-20. It took a minicomputer company to offer hardware this economical.

Not just anybody could have come out with a DECSYSTEM-20.

Because the DECSYSTEM-20 is the world's first general purpose computer to bridge the gap between big-system power and small-system price.

And that means the company that came up with it had to have a lot of experience in both big and small computers. And there is only one company that does.

Digital.

To create a DECSYSTEM-20, it took the same approach to computing that's made us the number one company in minicomputers.

That approach says that a com-

puter must first of all be affordable—giving you the most popular computer for the least amount of money.

With the DECSYSTEM-20, this approach meant giving you big system capability at a total system cost of under \$10,000 a month.

Our approach to minicomputers also said that a computer must be approachable. Meaning easy to install. Easy to use. And small in size.

With the DECSYSTEM-20, this approach meant giving you a full-scale general purpose system that installs like a dedicated mini. A sophisticated machine that

needs no operating staff and can be run interactively by just about anyone. All in a package that takes up about a fraction of the space required by other machines of similar performance.

But, to create a DECSYSTEM-20, it also took the same approach to computing that's made us the leader in large-scale interactive systems for the last eleven years.

That approach says a computer should offer you the kind of powerful software that will give you not simply everything you expect in a big system, but everything you need.

With the DECSYSTEM-20 this

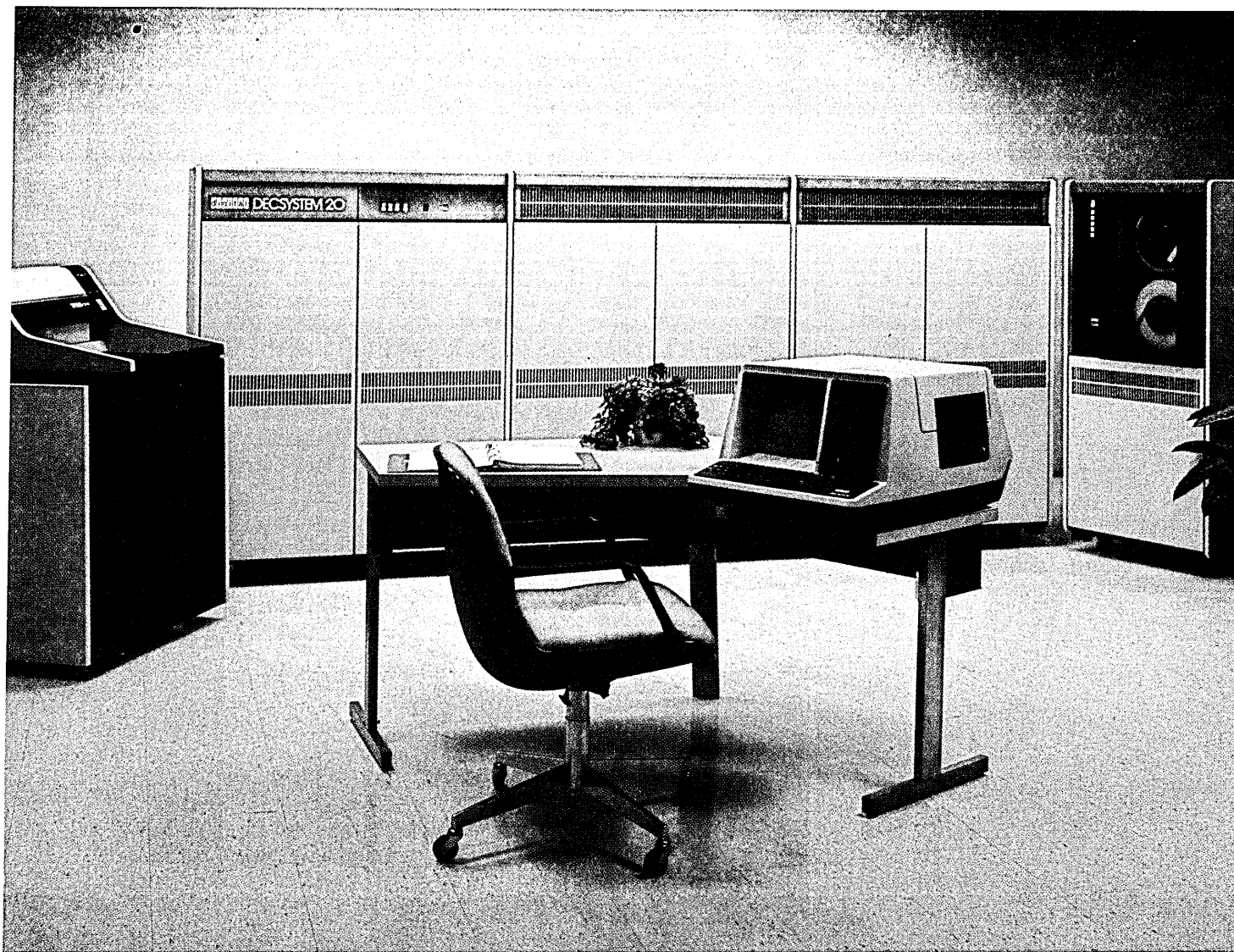

DECSYSTEM-20.

It took a large-scale computer company to offer software this powerful.

approach meant giving you a system with: Powerful, reliable multi-stream batch. Interactive capability to run up to 64 concurrent jobs. Complete higher-level languages including FORTRAN, COBOL, APL, BASIC PLUS, ALGOL, IQL, and CPL. A true demand paged operating system with large user address space for fast throughput. Six megabytes I/O bandwidth. Six megawords per second. ECL logic. A Data Base Management System. A Business Instruction Set. High system availability. Ease of conversion. Its own front-end mini for diagnostics and to run the peripherals.

Up to 1.2 million bytes of core memory. And up to 1.6 billion bytes of high-speed, on-line disc storage.

All of which is how the DECSYSTEM-20 combines the best of the big systems with the best of the small.

DECSYSTEM-20.
It had to be Digital's.

digital

LARGE COMPUTER GROUP

Bridging the gap.

Please send more information on the DECSYSTEM-20.

Please have a sales engineer contact me.

NAME _____

TITLE _____

COMPANY _____

ADDRESS _____

CITY _____

STATE _____

ZIP _____

TELEPHONE _____

Send to: Digital Equipment Corporation,
Large Computer Group, 200 Forest St.,
Marlborough, MA 01752.
Tel. 617-481-9511 ext. 6885.

DS

Decentralizing Data Entry With OCR

by Dennis A. McMullen

Now that more than 80% of computer input at Scotts is by OCR, costs have been cut in half.

For some time, because of the specialized requirements for hardware and the special skill required of personnel, data entry was performed by a centralized department. With today's advanced OCR technology, it is now possible to decentralize the traditional data entry operation. And, in moving from a centralized to a decentralized operation, it is also possible both to reduce cost and to improve the accuracy of the information being keyed.

O. M. Scott and Sons, an ITT subsidiary, manufactures and markets lawn care products for the homeowner and professional users. All company operations, except sales and some research, are centered in Marysville, Ohio. All information for input to the data processing facilities is sent to Marysville. However, within Marysville, the company is in four separate physical locations.

Prior to the move to OCR input, the data entry department was staffed with 23 people. The primary input device was the keypunch. In June 1972, some display terminals were introduced and the staff went from 23 to 15 people. The dual display and key-punch system was used until December 1973. At that time, OCR was introduced and a move to decentralize data entry operations began.

Today, the centralized data entry department consists of three full time and three part time members. In other areas of the company, approximately 12 people perform data entry on a part time basis. And as a result, the number and types of data entry errors have been drastically reduced.

The data entry environment

Scotts installed a Scan-Optics Model 20/20 optical scanner. It reads OCR-A typed or computer printed documents and numeric handprint, outputting on two 1600 bpi, 9-track magnetic tape drives. The scanner can read a document from a small name

card to a page size of 8½" × 13".

The scanner is physically located in the main data center area. It is programmed and operated by one person, and is maintained under contract by the manufacturer.

Input to the scanner is provided in four different forms: preprinted and typed pages; general purpose, free formatted typed pages; computer printed turnaround documents; and numeric handprinted documents. Currently we have one IBM 1403 line printer and approximately 30 IBM Selectric typewriters. The typewriters are scattered in ten different areas of the company, some located at secretarial stations.

Over 80% of all input to the main computer is produced by OCR means. (Approximately 10% is video display entered and about 10% is key-punched.) There is no proofreading of OCR documents after typing. Either the scanner program or the downstream computer programs thoroughly

edit the data for errors. Corrections for errors are, in most cases, handled by the department which produced the original input. Our error rate is amazingly low—less than 1% of typed and computer printed documents contain errors (see Table 1).

Order entry

A total of 45 different applications are scannable. Of these, only three applications use preprinted forms.

One of the most important applications is customer order entry. The order form is preprinted on continuous paper designed specifically for the company. Both the centralized data entry area and the order processing department use this form. When orders from sales personnel arrive in the mail, the order processing department batches and sends them to the centralized data entry area, where the data entry operator types the data onto the OCR form. Phone orders from

SOME RECENT OCR REJECT PERCENTAGES

Application	Recent Reject Rate (percent of forms processed)	Application Input Method
Accounts Payable	0.88%	Typed GF
Advertising Fund Claim	0.47%	Typed GF
Advertising Fund Checks	0.00%	Typed GF
Consumer Checks	7.45%	Typed GF
Customer Debits & Credits	0.61%	Typed GF
Customer Orders	2.77%	Typed PF
Freight Payments	0.44%	Typed GF
Lawn Care Renewals	3.80%	Turnaround
Marketing Sales Programs	2.75%	Typed GF
New Lawn Care Subscribers	0.02%	Typed PF
Purchasing	1.36%	Typed PF
Receiving	0.69%	Typed GF
Salesman Call Reports	3.11%	Typed GF
Vendor Updates	0.00%	Typed PF

Note: **Typed GF**—Typed General Purpose Form
Typed PF—Typed Preprinted Form

Table 1. Overall, the rejection rate is less than 1% of typed and computer printed documents. Rejection rates for specific applications appear here.

Discover

the one organized (and inexpensive)
way to keep up with what's new in
computer techniques and management—

The Library of Computer and Information Sciences

and start with
a whale of a value—

Take any 3 books for only \$1 each

(values to \$59.85)

if you will join now for a trial period
and take three more books— at member
discount prices— within the next 12 months.

(Publishers' Prices shown)

42045. DESIGN OF MAN-COMPUTER DIALOGUES. *James Martin.* The elements used in interactive systems, the basic process involved, and system application. *Counts as 2 of your 3 books.* \$22.50

39870. COMPUTER DATA MANAGEMENT AND DATA BASE TECHNOLOGY. *Harry Katzan, Jr.* One of the deans of America's computer scientists spells out the ABCs of data base systems, lays out the functions of these systems, and demonstrates which factors are important in deciding how each should be performed. \$15.95

70250. PRINCIPLES OF SYSTEMS PROGRAMMING. *Robert M. Graham.* Examines basic problems in the design, implementation, and maintenance of major software components— assemblers, loaders, macros, time sharing systems, and more. \$16.95

84385. TOP-DOWN STRUCTURED PROGRAMMING TECHNIQUES. *Clement McGowan and John R. Kelly.* Lays out the basic theory and spells out the applications of this powerful new technique. For experienced programmers. \$14.95

81880. SYSTEM ANALYSIS TECHNIQUES. *Edited by J. Daniel Couger and Robert W. Knapp.* 25 carefully selected papers tell how to properly evaluate an existing system, determine managerial information requirements, and assess the benefits. \$15.95

83765. THEORY OF DATA BASES. *B. Sundgren.* Trailbreaking exploration of the entire concept of data bases. Offers a framework in which different data base problems and aspects of research can be related and demonstrates how it is feasible to design data bases from a user's point of view. \$19.95

41665. DATA PROCESSING PROJECT MANAGEMENT. *Thomas R. Gildersleeve.* A step-by-step guide, stressing broadly applicable concepts. \$14.95

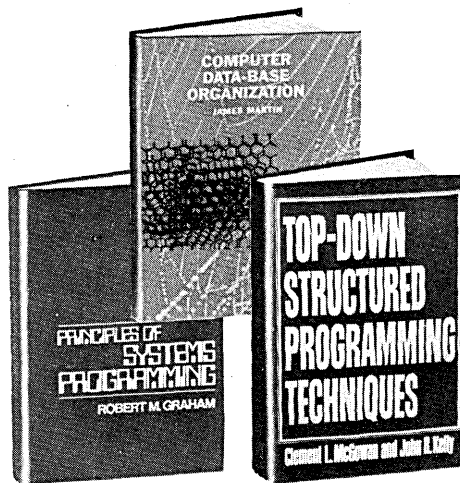

81950. SYSTEMS DESIGN AND DOCUMENTATION. AN INTRODUCTION TO THE HIPO METHOD. *Harry J. Katzan, Jr.* An invaluable handbook for anyone involved in design, implementation or documentation to this powerful technique for describing input- and output-oriented systems. \$12.95

62640. MICROPROCESSORS AND MICROCOMPUTERS. *Branko Souček.* Thorough account of the general programming and interfacing techniques common to all microcomputers and a complete rundown of all major microprocessor families. *Counts as 2 of your 3 books.* \$23.00

73191. QUEUEING SYSTEMS, VOLUME II: COMPUTER APPLICATIONS. *Leonard Kleinrock.* Takes informational processing theories and demonstrates how they can be used to solve real-world problems, particularly those relating to computer systems. *Counts as 2 of your 3 books.* \$25.00

52215. HANDBOOK OF DATA PROCESSING ADMINISTRATION, OPERATIONS, AND PROCEDURES. *S. R. Mixon.* Offers a future- and user-oriented system for designing, documenting, and controlling computer center projects. Plus a wealth of practical information on systems and programming techniques. *Counts as 2 of your 3 books.* \$24.95

41640. DATA COMMUNICATIONS DICTIONARY. *Charles J. Sippl.* Complete, up to date, cross-reference guide to over 14,500 data processing and communications terms. \$19.95

41620. DATA BASE MANAGEMENT. *William C. House.* 35 papers by leaders in the field thoroughly examining each of the major functions performed by data base systems. \$19.95

73190. QUEUEING SYSTEMS, VOLUME I: THEORY. *Leonard Kleinrock.* A trailbreaking work on the theory of queueing systems. "... a beautifully written innovative book. If you study queues, own this book."—*Ivan T. Frisch, Editor-in-Chief of Networks.* \$19.95

41675. DATA PROCESSING SYSTEMS. *Saul Stimler.* How to evaluate the performance of a DP system, determine when it's going to run out of power, and systematically plan for its future requirements. \$15.00

66485. OS DATA PROCESSING WITH REVIEW OF OS/V.S. *Harry Carroll.* Lays out the many levels of hardware and software that make up a modern system, then unveils the complex interactions among them. \$17.50

73860. RELIABLE SOFTWARE THROUGH COMPOSITE DESIGN. *Glenford J. Myers.* Demonstrates a unique and unified system of design measures, strategies, and techniques for developing highly modular programs. \$11.95

34640. ASSEMBLY LEVEL PROGRAMMING FOR SMALL COMPUTERS. *Walter J. Weller.* Professional introduction to Assembly level programming for mini- and microcomputer programmers. \$14.95

39865. COMPUTER DATA-BASE ORGANIZATION. *James Martin.* Hefty handbook on how you can use the latest design and implementation techniques to improve your data system's real-time accessibility and improve flexibility—at the lowest possible cost. *Counts as 2 of your 3 books.* \$26.50

65915. OPERATING SYSTEMS PRINCIPLES. *S. Kurzban, T. S. Heines, and A. P. Sayers.* Identifies the many levels of hardware and software that make up a modern system and then carefully explains the complex interactions that occur among them. \$16.95

How the Club Operates • The Book Club News, describing the coming Main Selection and Alternate Selections, will be sent to you 15 times a year at 3-4 week intervals. • If you wish to purchase the Main Selection, do nothing and it will be shipped to you automatically. • If you prefer one of the Alternates, or no books at all, simply indicate your decision on the reply form always enclosed with the News and mail it so that we receive it by the date specified. • The News is mailed in time to allow you at least 10 days to decide if you want the coming Main Selection. If, because of late mail delivery of the News, you should ever receive a Main Selection without having had the 10 day consideration period, that Selection may be returned at Club expense. • Continued membership past the trial period brings you the added benefits of our Bonus Book Plan—an important way to save more, at least 70% off publishers' prices.

If the reply card has been removed, please write to
**The Library of Computer
and Information Sciences
Dept. 7-5AF, Riverside, N.J. 08075**
to obtain membership information and an application.

DECENTRALIZING

salesmen to the order processing department are typed directly by a clerk onto the OCR document while receiving the information over the phone. (Long orders are recorded.) The OCR document now becomes the source document or a record of the original order as sent by the salesmen each day.

By midafternoon all documents are gathered and scanned. The magnetic tape produced from the scanner with the orders on it is taken to the cpu where it is edited and the order quantities are balanced. Another result of the processing is a general list of all the orders for that day which are rejected by the editing program, such as for an invalid stock number. The good orders are saved on magnetic tape for

ferred to the cpu, and rejects are returned to the purchasing department. After scanning, the form is saved for purchasing records. The difference in processing this form is that it is prepared directly by the using department.

For these systems, the percent of rejection is only 2% of documents processed, which is quite low.

Most applications make use of a general purpose, continuous form for input. The form we use is 8½" × 6". Ten characters to the inch are typed on the horizontal, which permits up to an 83-character line. Typing is normally double spaced, permitting entry of up to 16 lines. Continuous forms are used in the centralized data entry area and in some other areas of the company. These forms facilitate greater production since the operator does not have to feed new forms constantly to

bar (|). If a field is absent, it is indicated by typing the next character as a vertical bar

Some of the applications entered by this method are: accounts payable, accounts receivable, receiving data, customer debits and credits, freight information, and prospective customers.

One of the highest volume applications for which OCR entry is used is the maintenance of Scotts' *Lawn Care* magazine name and address file. The file size is about 9.5 million names. Annually about 500,000 names and addresses are added and/or changed.

New names and addresses are OCR typed on a preprinted post card. After the post card is scanned and captured on magnetic tape, it is used to mail to the subscriber acknowledgment of his subscription. Changes are handled in the same manner.

Once a year the name and address file is purged. Any subscriber on the file for two years is considered for purging. However, before purging, a notice is sent with his last copy telling him he will be dropped if he doesn't return an attached card. (This card uses a Cheshire label created on the line printer with a scannable check digit code.) Over a half million of these cards are returned each time the file is purged. Our error rate for scanning this turnaround document is relatively low at 3.8% of forms read.

Further areas

The area most fertile to further OCR work is in applications which deal with entry by numeric handprint. The first such application, now in testing, is entry of payroll timecards. For each hourly employee within the organization, a payroll card is required weekly. Scotts does not use a time clock, or any device which would mark the time on a timecard. The employee is trusted to mark his total hours worked, sign the card, and then have it countersigned by his supervisor before it is forwarded to the payroll section. This application lends itself very well to entry by handprinting since all the information on the timecard is numeric in nature. (Shown in Fig. 2 is the proposed timecard for entry by numeric handprint.) The numeric timecard will be used almost in identical fashion as the current keypunched card.

The system will work as follows: The OCR numeric payroll timecard is designed to be a continuous form so that the employee's name, employee number and department number can be preprinted in OCR-A font by the line printer. After printing, the cards will be forwarded to each employee as his official timecard. The employee will fill out the timecard just as he now does. At the end of the week, he will sign the card and turn it over to his super-

Fig. 1. By having the user department, in this case Purchasing, enter data directly onto this specially designed OCR form, no transcription is necessary—and transcription errors are accordingly reduced.

further processing.

As for the efficiency of this system, we have processed upwards of 2,500 orders through the system with an average of three data entry personnel. We consider this system quite unique, and very workable.

Purchasing and other applications

A preprinted form was designed and prepared by the inhouse printing department for input by purchasing department clerks. A sample is shown in Fig. 1. After the purchasing clerk types the forms on an OCR Selectric typewriter, it is forwarded to the scanner. Accepted orders are placed on magnetic tape which is then trans-

ferred to the typewriter. For these continuous forms, the typewriters are equipped with off-the-shelf pin-feed platens which can be easily installed and removed by the typist.

The applications which use the form are typed using a combination of keyword identifiers and particular position placements. Each application has its own set of characteristics and therefore its own programs. The keyword formats are indicated by the use of a fork (F) or a chair (H) character immediately followed by a number designation. The number designation identifies the number and type of fields that are present in the record. Each data field is separated by the vertical

*A micro-size
message from
Rodney
Dangerfield*



I tell you, I always had respect for computers! But now I got respect for 3M COM! Look at this! Totally dry COM on one side...low-cost COM graphics on the other! Nobody else has got either one! 3M must be driving their competitors nuts!

Want the convenience of COM right in your computer room? Get 3M LBR, the only totally dry COM. No liquids, no chemicals because LBR uses amazing laser beam technology.

Want pie charts, bar charts, and graphics on microfilm—to make data easier to understand and decisions easier to make? Get a 3M Beta System. It's the only low-cost COM with built-in graphic capability.

Want COM that converts print tapes to microfilm without heavy programming? 3M's mini-computer-controlled Beta System offers that, too. Conversion is easily accomplished, with simple operator-entered job parameters. Find out more. Write Microfilm Products Division, 3M Company, St. Paul, MN 55101 for full details on LBR and Beta COM—and 3M's full range of software and support services.



3M
COMPANY



**There's a very thin line
between making it
or breaking it.**

**That's important to remember
with high-density drives.**

The advantages to 6250 CPI recording — like higher data transfer rates and a reduction in library size requirements — are numerous.

But there are also some disadvantages. One of them is the masking by the GCR format. Because of it the only way to get an accurate error listing is through sense byte interrogation. Ask your Graham product technology man why.

Because of unnoticed errors serious degradation in read/write reliability can occur. This is compounded by debris from bargain-priced computer tapes, which don't have the modulus of toughness and durability of Epoch 4.

Get certified error-free Epoch 4. It makes all the difference. Now — and for the future.

 **GRAHAM
MAGNETICS**

Graham, Texas 76046
CIRCLE 25 ON READER CARD

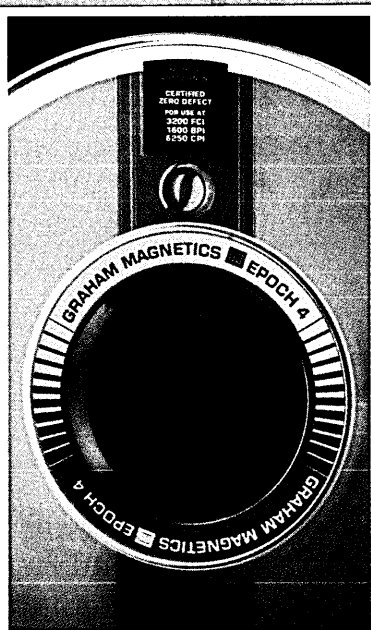

DECENTRALIZING

visor. The supervisor will assign it, group all the cards from his department, and forward them to the payroll department.

After receipt of the timecards in the payroll department, they will be forwarded directly to the scanner for processing. Corrections will be made at the scanner by the scanner operator. At this point, the magnetic tape will be taken from the scanner and the data will then proceed along its normal path through the payroll system.

Not all timecards can be completed as easily as described. However, 90% of the cards will follow this system; they will be filled out by office, technical, and production employees. The other 10% of the cards are for extra type of recording activity for labor distribution purposes, including labor transfers.

We are in the early stages of testing this process, and realize that the application will require some training in clear and legible writing (so a "4," say,

OCR COST SAVINGS

With Traditional System:

Item	Approximate Monthly Cost
22 Keypunches and Verifiers	\$ 2,200
23 Data Entry Operators	17,000
	<u>\$19,200</u>

With OCR System:

Item	Approximate Monthly Cost
2 Keypunches	\$ 300
2 Video Display Terminals	300
3 Full-time Data Entry Oper.	2,300
3 Part-time Data Entry Oper.	1,200
1 Full-time Programmer/Oper.	1,300
Scanner Depreciation	2,200
Scanner Maintenance	1,900
Additional Forms Cost	200
Typewriter Depreciation	300
	<u>\$10,000</u>
NET MONTHLY SAVINGS	\$ 9,200

Table 2. In going to OCR, a reduction from 23 data entry operators to three full and three part time operators helped achieve a cost reduction three times as great as originally estimated.

DAY	IN	OUT	PAID ATTENDANCE	PAID ABSENTEEISM	TOTAL HOURS
MON	/	8.0			8.0
TUE	/	6.0	2.0		8.0
WED	/			8	8.0
THUR	/	4.0		4.0	8.0
FRI	/	8.0			8.0
SAT					
SUN					
TOTAL HOURS					40.0

Fig. 2. Handprinted timecards represent a novel application for OCR, and will soon become part of Scotts' standard procedures.

will not be mistaken for a "9"), plus a lot of fine tuning as the system progresses to maturity. However, we feel that it is a very real and manageable system. The system as described will not be implemented 100% from the start, but will grow by phases, one or two departments at a time.

Two other applications should be mentioned as being planned for future OCR work. One is input of physical inventory data; the other is the direct entry of customer orders by OCR numeric handprint.

What was accomplished

Over the past few years, it has been extremely gratifying to the systems designers and to the dp personnel at O. M. Scotts to see this OCR system function well and economically. It has met expectations far beyond originally anticipated—cost reductions exceeded expectations by a factor of three, in fact—and management feels this form

of entry is extremely economical to operate. It has accomplished several things.

One, it has specifically reduced cost by over \$9,000 a month. Table 2 illustrates the "before" and "after" monthly cost. (The cost savings are measured relative to conditions which existed prior to June 1972.) They also include then some savings generated as a result of conversion to displays which occurred during the period June 1972 to December 1973. Full typewriter depreciation is not included with today's cost since most typewriters are used at secretarial stations for normal correspondence work.

Two, it has made data entry available to all areas of the company, thus facilitating the decentralization of data entry capability within the order processing, purchasing, accounts payable, accounts receivable, manufacturing, marketing, and subscription departments.

Three, it has reduced the number of errors and improved the accuracy of information entered into the system. Specific error rates were not available prior to conversion, and cannot therefore be quantified. However, we recognized three significant improvements:

- Errors are controlled by the source input area.

- The number and frequency of transcription errors are reduced. Since input is prepared in the user area, there is no need to transcribe the data onto a transmittal form. Therefore two sources of errors are eliminated: one, transcribing the data from source to transmittal; the second, transcribing the data from transmittal to a data card.

- The number of errors due to loss of data is reduced. No longer do we lose transmittals or documents flowing into and out of a central area.

Four, it has made data entry available to those who have no specialized data entry devices except the typewriter. Typewriters are readily available throughout the company. New applications for those typewriters are easy to install. Typing formats are designed to conform to the sequence of source documents. Quite frequently new applications are installed within hours.

Five, it has made data entry extremely efficient. Documents are typed and sent to the scanner. The documents are then returned to the using areas. Data then proceeds through the downstream systems by way of magnetic tape, which is output from the scanner.

Overall, we consider it a wise choice to have made the decision to use this form of data entry at our company. *



Mr. McMullen is manager of information processing at O. M. Scott & Sons, Marysville, Ohio. Actively involved in optical scanning work for the past five years, he has also been manager of Systems at Scotts, and before that at Xerox-American Education Press, Columbus, Ohio. He was previously also assistant to the systems development manager at Chemical Abstract Service, Columbus, Ohio.

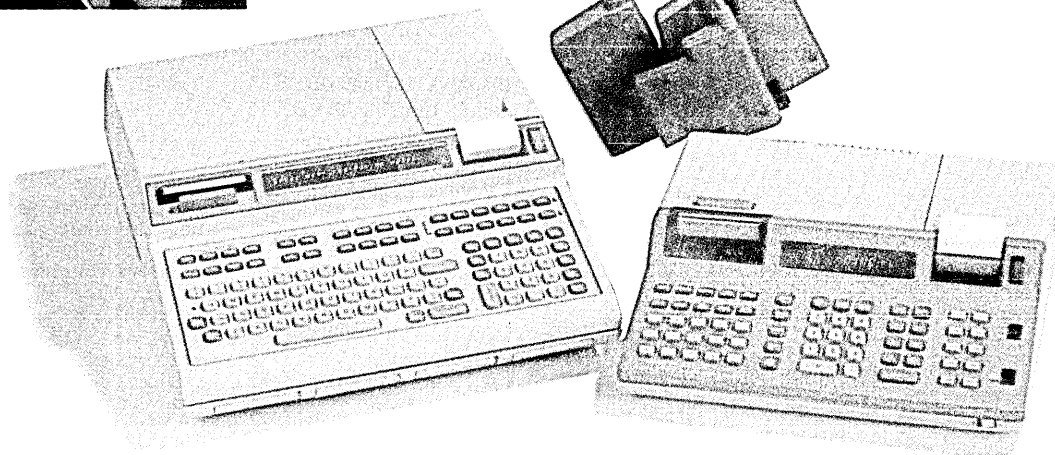
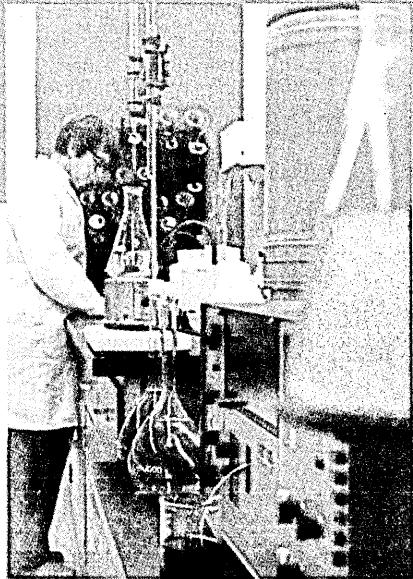
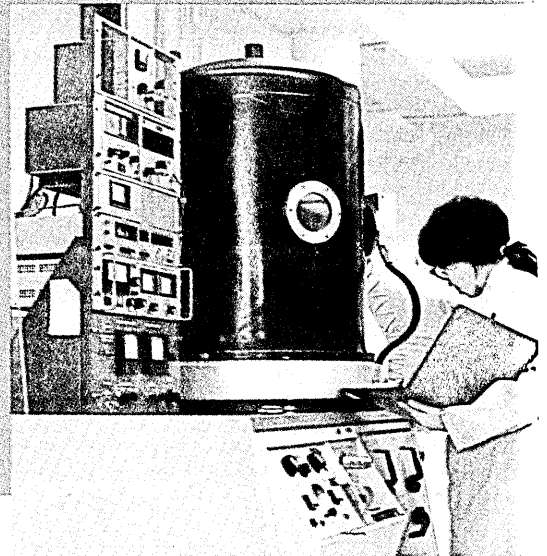
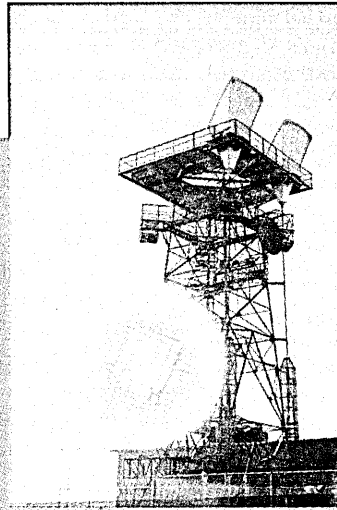
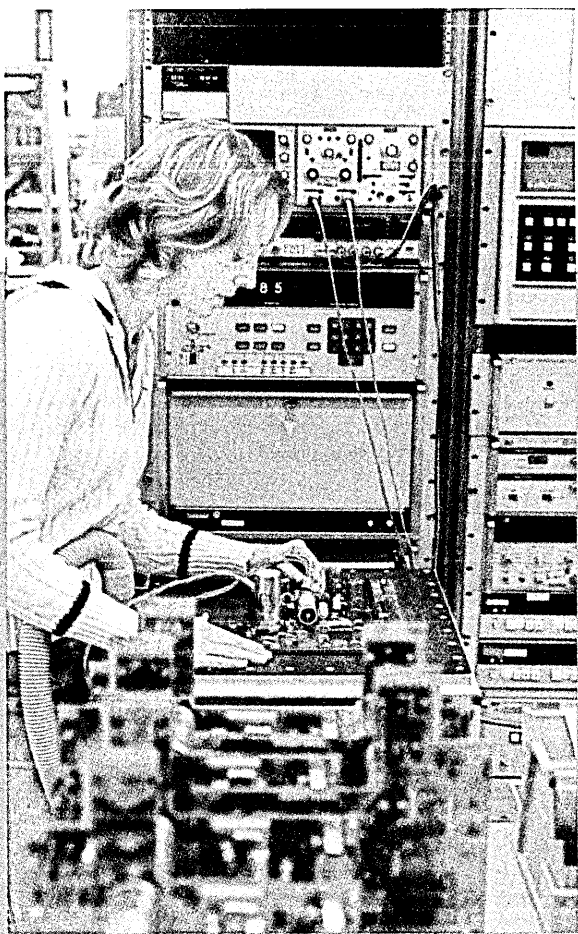

Automate your instruments.

Our new computing controllers make the connection friendly.

The new HP 9815 and HP 9825 computing controllers make interfacing practical and inexpensive. If you haven't automated your instruments yet, hook them up to one of these HP controllers and upgrade your system's performance. You'll get results and reports faster and easier. Increase your system's throughput. Control variables in real-time. Free yourself from manual readings, adjustments, and calculations.

No matter what your interfacing requirements are—simple data logging, dedicated instrument control, data communications or large-system integration—you'll find these controllers can save you time and money while increasing your productivity.

Interface cards and simplified programming make interfacing easy.

You can choose from the commonly used interfaces—BCD, bit-parallel/byte-serial, RS-232C, or HP-IB (the inter-

face bus that conforms to IEEE Standard 488-1975). You simply connect your instrument or black box to the cable of the appropriate HP interface card and plug the card into the controller. Then, using simple high-level commands, you program the computing controller to monitor and control your instruments and analyze the data. You don't have to hire a computer programmer to set up and use an automated instrumentation system. That's the friendly, direct approach to interfacing.

The HP 9825: unexpected power for systems control

Though the 9825 retains the friendliness and programming simplicity of a calculator, it has the power and performance of a minicomputer. Features

like vectored priority interrupt, buffered I/O, live keyboard, and direct memory access allow it to do several interfacing jobs simultaneously: transferring data and commands, accepting inputs, analyzing data and printing or plotting results. And the 9825 can run application programs and solve keyboard calculations at the same time. Using HP-IB, it can control as many as 42 instruments and peripherals at once. That's big system performance.

Let an HP 9815 supervise your instrument.

The 9815 at a base price of \$2,900* (I/O option and interface cards/cables extra), is the inexpensive alternative to manual monitoring of an instrument or small system. It can even run control appli-

cations unattended. And it can handle a variety of sophisticated computations as well. Truly, the 9815 provides a lot of performance for the price.

Improve your system and become more productive, too.

No matter what kinds of instruments you use—scanners, counters, spectrometers, meters, converters, chromatographs or your own black box—an HP computing controller can help you utilize them and their outputs more effectively. And in the process, free you for more productive, creative work.

We have a brochure that details the features and techniques of simplified interfacing using HP computing controllers. Call your local HP representative for your copy, or circle our number on this publication's reader service card.

*Domestic U.S.A. price only

HP computing calculators put the power where the problems are.



Sales and service from 172 offices in 65 countries.
P.O. Box 301 Loveland, Colorado 80537

COBOL

DATAPOINT ANSI COBOL IT'S THE REAL THING

Datapoint's new COBOL compiler, created for our 5500 Series advanced business processors, offers more than just the name. It's a true COBOL capability, an implementation of ANSI-68 (American National Standards Institute) specifications, with selected features of ANSI-74 standards also included.

Implementation levels from the ANSI COBOL standards are: NUCLEUS, Level 1; TABLE FACILITIES, Level 2; SEQUENTIAL ACCESS, Level 1; RANDOM ACCESS, Level 1; SORTING FACILITIES, Level 2; SEGMENTATION, Level 1; and LIBRARY FACILITIES, Level 2. Extensions added to take advantage of the unique dispersed processing capability of the Datapoint 5500 include GEDIT format files, cassette tape support, DATABUS and EBCDIC numeric formats, indexed sequential file access, CALLING pre-compiled sub-programs and DEBUGGING facilities.

COBOL programs can be compiled on Datapoint's 5548 advanced business processor with disk storage, while execution of those programs can occur on any disk-based 5500 Series processor. Optional peripheral support includes tape, printer and card reader.

With the new compiler, COBOL programs written for other computer systems, such as IBM, Hewlett-Packard, Data General, Burroughs, and many others, can be run on Datapoint equipment without major alteration. For companies wishing to develop or expand their computer networks, they can now do so utilizing their existing investment in COBOL programs.

For organizations contemplating mainframe upgrades, Datapoint offers a cost effective alternative. With the new compiler, COBOL work can be taken off the mainframe and

handled by dispersed processors at field locations. Or the Datapoint processors can work with entirely autonomous data bases and handle complete processing for field users.

Other advantages include file compatibility between programs created in COBOL and any of the other Datapoint programming languages, including BASIC, RPG II, DATABUS and DATAFORM. Users of Datapoint's multi-terminal DATASHARE systems may execute their programs at the same time COBOL programs are being executed under the PARTITION SUPERVISOR.

Users may secure the necessary COBOL software license for a one-time charge of \$2,500 plus \$20 per month for maintenance support and documentation. If the user wishes to pay at a monthly rate, the charge is \$65 per month for the license fee and \$20 for the maintenance fee.

Like we say, Datapoint COBOL is the real thing. For more information, contact Datapoint Corporation, Attn: Product Marketing, 9725 Datapoint Drive, San Antonio, Texas 78284. (512) 690-7151.

DATAPOINT CORPORATION



The leader in dispersed data processing™

Datapoint's 5500 Advanced Business Processor can now be utilized with a COBOL compiler designed to ANSI specifications. Datapoint ANSI COBOL — it's the real thing.

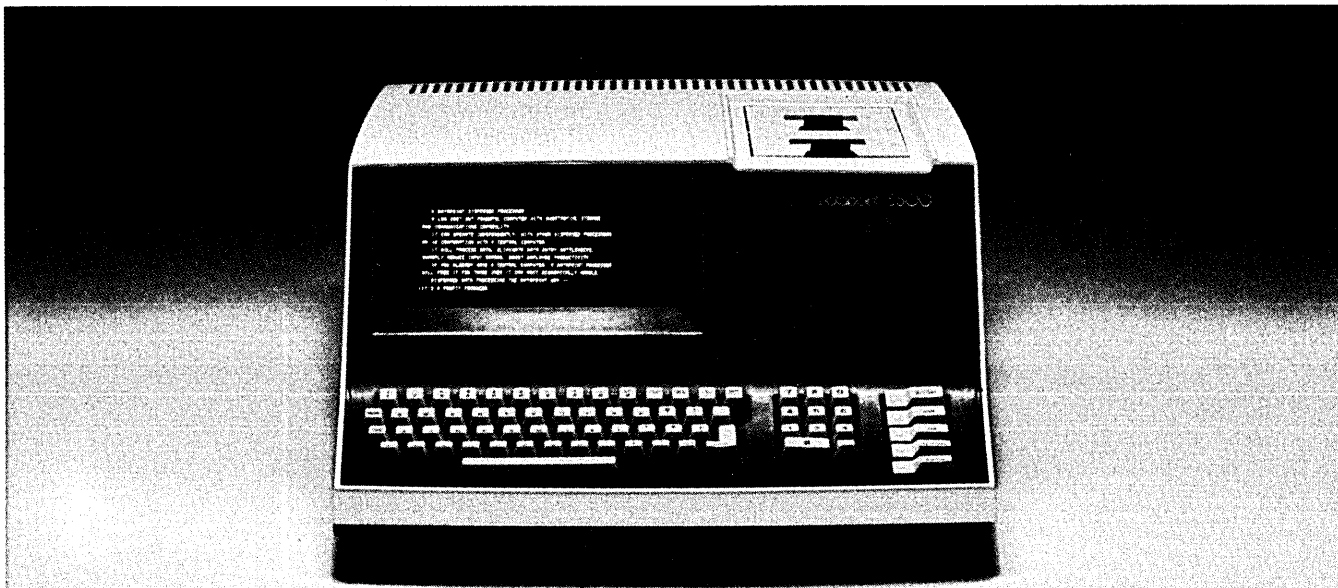

Home Office: 9725 Datapoint Drive, San Antonio, Texas 78284 (512) 690-7151 • **Sales Offices:** Atlanta/(404) 458-6423 • Boston/(617) 890-0440 • Chicago/(312) 298-1240 • Cincinnati/(513) 481-2600 • Cleveland/(216) 831-0550 • Columbus/(614) 457-1722 • Dallas/(214) 661-5536 • Denver/(303) 770-3921 • Des Moines/(515) 225-9070 • Detroit/(313) 478-6070 • Greensboro/(919) 299-8401 • Honolulu/(808) 833-2110 • Houston/(713) 629-7760 • Kansas City/(913) 321-5802 • Los Angeles/(213) 645-5400 • Memphis/(901) 761-3080 • Milwaukee/(414) 453-1425 • Minneapolis/(612) 854-4054 • New Orleans/(504) 522-5457 • Newport Beach/(714) 752-9073 • New York/(212) 736-3710 • Orlando/(305) 896-1940 • Philadelphia/(215) 667-9477 • Phoenix/(602) 265-3909 • Pittsburgh/(412) 344-6800 • Portland/(503) 223-2411 • Rochester, N. Y./(716) 385-3450 • San Francisco/(415) 398-2888 • Seattle/(206) 455-2044 • Stamford/(203) 359-4175 • St. Louis/(314) 878-6595 • Tulsa/(918) 664-2295 • Union, N.J./(201) 964-8761 • Washington, D.C./(703) 790-0555 • West Hartford/(203) 278-0660 • **International:** TRW/Datacom — International/Los Angeles, California, TELEX 691286 (213) 475-9861 • Sydney, Australia/(2) 922-3100 • Vienna, Austria/(0222) 36 21 41 • Brussels/3762030 • Rio de Janeiro, Brazil/222-4611 • Toronto/(416) 438-9800 • Copenhagen/(01) 105 366 • Guayaquil, Ecuador/394844 • London/(1) 903-6261 • Helsinki/90-661 991 • Paris/(1) 657-13-31 • Hannover, Germany/(0511) 634-011 • Piraeus, Greece/423-471 • Rotterdam/(10) 216244 • Hong Kong/(5) 243-121 • Tel Aviv, Israel/(03) 221874 • Milan/316 333 • Tokyo/(03) 264 6131 • Kuwait City, Kuwait/419-550 • Oslo/(02) 35 75 80 • Makati Rizal, The Philippines/877294 • Singapore/915822 • Johannesburg/724 9301 • Madrid, Spain/262 7601 • Stockholm/(8) 188295 • Lyss Berne, Switzerland/(32) 844240 • Taipei, Taiwan/768-1114

Going Cardless

by Vince Heiker

The punched card has outlived its usefulness. Already forsaken for programs and data, now it is losing its last staunch supporters in the computer room.

While many shops currently use cardless data entry methods, few have attempted to eliminate cards in programming and computer operations. Only a small number of shops do use their key-disc, key-tape or key-diskette devices for programming. However, cardless computer operation is being largely ignored. This is probably because, at first glance, the conversion effort involved seems too costly, compared with the benefits offered by cardless operation. With IBM's announced support of cardless 370/115-2 and 370/125-2 systems, effective September, 1976, this advancement is likely to receive increased management attention.

Any IBM shop running under DOS/VS, Release 31 or subsequent releases, with POWER/VS, can convert to cardless operation. While IBM's cardless marketing emphasis appears to be aimed at 115-2 and 125-2 users, there are no technical or field engineering support limitations for cardless computer operation on even the 168.

Why do it?

One major justification for replacing JCL cards with JCL diskette or tape in computer operations is to reduce costs. Unit record equipment, card readers, card punches and the remaining keypunch devices can be eliminated. Keypunch card usage, card back-up, card storage and card handling problems can be eliminated.

A second major reason is to reduce computer operator errors. The operations supervisor can maintain better control over JCL and parameter records. There are no card decks to drop or reassemble into an incorrect sequence. The operators are provided much less opportunity to improperly change JCL.

A third major reason is to improve processing efficiency. Job control lan-

guage and run parameter records can be read much more quickly than from card readers. Similarly, output records can be written much faster to tape, disc and diskette devices than to card punches.

Fourth, JCL and run parameters can be prepared more quickly and accurately on programmable key-disc and key-diskette devices. When combined with cardless programming, this can substantially reduce the number of compiles and tests required for new applications.

Fifth, JCL back-up and software work are easier.

Sixth, if diskette terminals are used, telecommunications interfaces between terminals and the mainframe can be simplified. An IBM 3540 diskette I/O device can be attached to the mainframe to write out diskettes for transmission, instead of communicating with terminals by using an integrated communications adaptor (ICA) and BTAM, VTAM or CICS/VS. By using terminal to terminal transmissions in place of mainframe to terminal, complex operating system problems are avoided and the configuration often is less expensive.

Our objectives in converting to cardless processing were to:

- Slash actual cash costs of labor, equipment and supplies in coding, key-punching and computer operations by at least \$1,200/month.
- Speed up cash flow by speeding up data collection.
- Improve accuracy of coding, data entry and computer operations.
- Increase the productivity of data entry personnel.
- Reduce system design and programming complexities caused by the size restrictions of 80-column cards.

We chose to convert to IBM 3741

single-station key to diskette units. We expected this to yield other advantages too, compared with clustered key-disc systems:

- Only a minor conversion cost was required.
- Reduced risk, since each 3741 key-diskette device is a standalone key station, not dependent upon a clustered system's centralized disc drive, mini-computer and operating system.
- Fewer overhead tasks for the data entry supervisor.
- No disc to tape or tape to disc data conversions necessary.
- Unlimited storage capacity of diskettes, compared with limited capacity of clustered key-disc devices.
- Little training was required.
- No change to physical facilities. No special power connections, space increases or air conditioning changes were required.

The conversion

Conversion was relatively simple. First, unit record equipment and processing were eliminated, since sorts and merges are possible but not practical on key-diskette devices.

Second, while this was not absolutely necessary, job streams were changed to minimize JCL sets, to keep the required quantity of JCL diskettes low and to avoid the same rerun hazards presented by card decks. (For example, requiring operators to change JCL at run time, in order to run a job in a partition different from the one normally used for that job, is a very error-prone proposition. The alternative method of establishing multiple JCL sets, to cover each combination of partition and job, not only increases maintenance efforts and diskette usage, but also presents the operators with the

CARDLESS

opportunity to select the wrong JCL set for a partition. In both cases, more than one partition can be affected, often causing several processing disasters and reruns.)

Permaneer has approximately 600 batch application programs in a mixture of RPG II, BAL, FORTRAN, a subset of COBOL and full COBOL languages. These applications involve about 150 basic job streams for accounting, manufacturing, and sales systems. The systems include normally scheduled jobs as well as a significant number of batch inquiry and special request jobs.

Prior to the data entry study, a team of three senior-level programmer/analysts and the computer operations supervisor converted all job streams to be partition independent. Since JCL was being changed anyway, the use of tape files by interim job steps was eliminated. All sort JCL was catalogued on the Procedure Library. All permanent disc files and all temporary disc work areas were set up using standard labels exclusively. All of the remaining run JCL, except POWER/VS job records,

planned, at Permaneer, for late 1976.)

Additionally, we have our own utility, TIPS, which is used to condense print image records for transmission, and to replace 1403/3203 mainframe printer carriage control characters with those required by the printer of receiving terminals. This had to be changed to the blocking and carriage control requirements of 3717 printers which attach to 3741 key-diskette terminals at remote plants.

The easiest conversion method is to simulate a card reader and card punch with the 3540 diskette I/O device, to avoid recompiling source programs. As long as 80-column records are used, the 3540 can function as a card reader and card punch.

To achieve this, all production job streams were first catalogued in the Source Statement Library using the SLI feature of POWER/VS.

Second, POWER/VS control records were set up on diskettes. Fortunately, IBM had announced the availability of a diskette utility (5798-CGH) just prior to our conversion. The 2560 card reader/punch remained temporarily installed along with the 3540, using an RPO, during this conversion step. This

at the beginning of each input data set. While processing the SLI book, POWER/VS searched for a corresponding input data statement and loaded the data set following the statement in place, within the job stream, as if the entire job stream were being read from a card reader.

This conversion effort required about one man-day of programming per each 35 application programs. Computer operator training was less than one day for each operator.

Keypunch operators were trained in about a week. They also set up their own input formats in the same week, without assistance from the programming staff. However, this conversion did not include programming the 3741 to use formats for prompting, nor did it include using editing capabilities beyond the format level.

The computer center was converted to cardless operation within a week after the equipment was installed, for all scheduled daily and weekly production jobs. The remaining monthly, quarterly, annual and special request jobs were converted within the following three weeks, including the special programs and utilities previously stored in card decks by each programmer for his own use.

Being cardless has provided no serious obstacles for software or programming work. Programmers now routinely key their own program code and program corrections, when necessary. IBM provides software on magnetic tape instead of on a mixture of tapes and card decks.

Better than expected

The benefits derived from the conversion to cardless data processing exceeded the anticipated savings and objectives in several ways:

- Only four reruns due to computer operator errors occurred between November 3, 1975, and August 1, 1976.
- Cash savings are \$2,000 per month, or about double the amount anticipated. These increased savings resulted from: reduced computer and data entry overtime, reduced supplies usage, and reduced computer meter time because of the dramatic rerun reductions achieved; faster input/output processing than expected; greater computer and data entry productivity increases than expected; and cancellation of features which were found to be unnecessary, after installation.
- By standardizing on 3741s as terminals and data entry devices, MIS support for remote locations has greatly improved, due to better knowledge about the terminal hardware and software.
- Recruiting new MIS personnel has become much easier because of the



The IBM 3741 is a single-station key to floppy disc data entry unit with a display (far left). Permaneer Corp. now uses the unit for all input—programs, data, and even JCL. (Diskettes are fed to the 370 through a 3540 diskette peripheral which simulates a card reader/punch.) Application programs were converted to cardless operation in less than two hours each.

was set up on the Source Statement Library. These changes substantially improved processing efficiency, reduced reruns and allowed use of only one set of JCL regardless of the partition selected at run time by the computer operator.

The foregoing job stream changes required an average of 1½ man hours per application program. POWER/VS JCL should also have been set up on a library, but this facility does not yet exist for DOS/VS. (This last step is

allowed us to transfer JCL from cards to diskettes, avoiding the otherwise necessary requirement to re-key and test POWER/VS JCL. A "data" statement was inserted immediately after each EXEC statement for programs requiring card input. The data statement operand contained the phase name of the program executing within the SLI book. Thus, data sets keyed by a 3741 onto diskettes were linked to a specific job and job stream and isolated from job control by using a data statement

Jacquard's J100 Videocomputer is the best of both worlds. California creativity resulted in balanced hardware and software with a cost/power ratio and flexibility you can't get anywhere else. Interscan Data Systems and their conservative British customers proved the J100 in use.

Rx for congested mainframes. The data-base management and communications capabilities of the J100 make it ideal for distributed processing. Individual units of large DP networks can use the power of the J100 to bring direct control to their operations.

J100 stand-alone capabilities stand alone. You can enter orders, run a payroll and write a new program at the

same time on J100's CRT terminal-oriented, real time, multi-tasking operating system. And each user has full power available.

Software is the key. The heart of Jacquard's flexibility lies in its unique software. In addition to a time sharing operating system, we've designed an extended BASIC compiler which generates re-entrant code for efficient use of memory and fast running programs. Our keyed-indexed file handling results in very fast response to inquiries, regardless of file size.

A comprehensive range of software tools, operating systems, languages, communications emulators and over 60 utilities are available.

Check the specs. Then write for our brochure. The best of both worlds, at the best price.

SPECIFICATION CHART

J100 Processor:

16 bit word, up to 128K bytes, DMA, APL, Power Fail Auto Restart, Real Time Clock, 1920 ch CRT and Keyboard, built in Floppy Disks.

Peripherals:

Up to 30 satellite CRTs, 5 Megabyte Cartridge Disks and 80 Megabyte Drives, 800 and 1600 BPI Tape Drives, Multiple Printers: 30 cps to 900 lpm, Async/Bisync communications.

All software supported, available now.

Jacquard J100. British conservatism proved our California creativity.

Manufactured by
**JACQUARD
SYSTEMS**

2502 Broadway
Santa Monica, CA 90404
(213) 829-3493
TWX (910) 343-6967
Distribution in
North, Central
& South America,
Japan.

Distributors
Please write
Jacquard
Systems

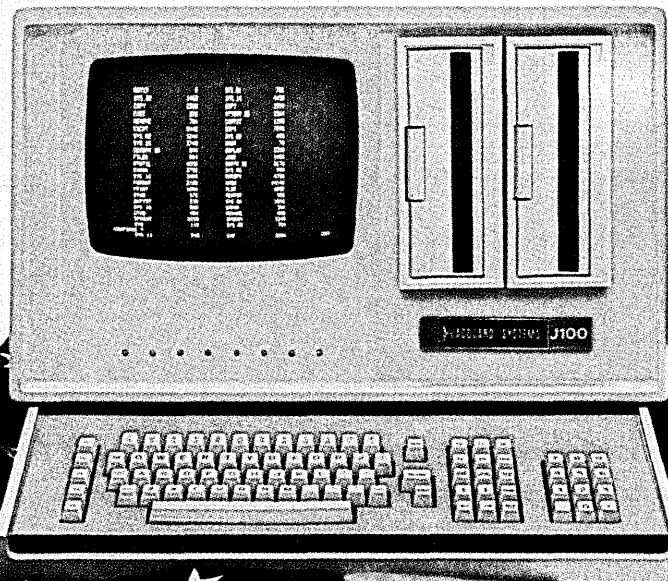

**INTERSCAN
DATA SYSTEMS
(UK) LTD.**

Hoechst House
Salisbury Road
Hounslow, Middlesex
01-572-2871
TWX 851-934-135

Distribution in
Europe, Africa
& Australasia

MAGNETICALLY SHIELDED TAPE DATA PRESERVERS

Protect your magnetic tapes from degradation and physical damage. Designed for storage, shipment and hand carrying. A wide choice of models and capacities available for standard reels, discs, disk packs, flexible disks and cassettes. Immediate shipment from stock.

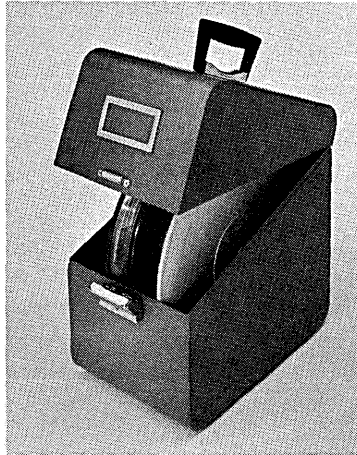

MAGNETIC SHIELD DIV.



PERFECTION MICA CO.
740 N. Thomas Dr.
Bensenville, Ill. 60106
Ph. (312) 766-7800
TWX (910) 256-4815

SEND FOR NEW
TP-5 CATALOG

CIRCLE 140 ON READER CARD

6 Proven Ways To Better Your Profits*

- Manufacturer's wage rates: \$2.50-4.50 per hour
- Property cost \$4,000 to \$20,000 an acre
- State corporate income tax only 5%
- No state income tax
- Right to work law - yes
- Low tax rates; building and property; city, 3.38; county 11.99 mills

Ocala/Silver Springs FLORIDA

(*And More - Write for your FREE copy of "Profit Facts")

NAME _____ TITLE _____
COMPANY _____
ADDRESS _____ PHONE _____
CITY _____ STATE _____ ZIP _____

Industrial Development Div. COMMITTEE OF ONE HUNDRED
P. O. Box 495-A, Ocala, Florida 32670

In cooperation with the Florida Department of Commerce

CIRCLE 131 ON READER CARD

CARDLESS

professional status associated with being completely cardless. (For example, prior to the cardless conversion, it was difficult to attract programmer/analysts and computer operators for job interviews, because Permaneer's batch processing orientation and relatively small hardware provided nothing unusually interesting or exciting to experienced professionals. Since the conversion, the quality and quantity of applicants has noticeably increased along with Permaneer's local reputation.)

- New systems designs are no longer limited to 80-column record lengths, which has helped to avoid using multiple input record types and has saved the extra programming otherwise required by multiple records.

- Keystroke rates have improved about 40% over keypunch devices. Depending upon the type of input, rates as high as 14,000 keystrokes per hour have been achieved.

- Keying errors have been dramatically reduced, to the point that other departments have spontaneously commented about the improved accuracy. There were only five reruns caused by keying errors between November 3, 1975, and August 1, 1976.

- Some user areas have begun training on the 3741s to eventually eliminate the need for transcription in preparation for keying, and as an interim step for some applications to be converted to on-line data capture.

The cardless data processing concept deserves serious consideration by your company. It is a relatively easy conversion and it offers substantial cash savings, productivity increases and improved MIS performance. *

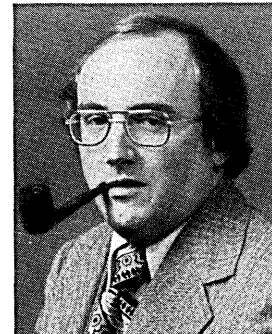

Presently director of MIS for Permaneer Corp., Maryland Heights, Missouri, Mr. Heiker is responsible for systems analysis, programming, and operations there. A member of SMIS and ASM, he has had 10 years of experience in dp with Permaneer, Malinckrodt, and Emerson Electric Co.



First we gave you the HARRIS 1600 with a mainframe-type operating system for money-saving remote communications. Now there's more!

Distributed processing. That's what's happening with the Harris 1600 Remote Communications Processor.

We already had a good thing going with the 1600's multi-emulation capability . . . and you've had one going with the resulting savings in hardware and reduced line costs. But we promised even more savings to come: the ability to distribute your central data base through local processing of data at the remote site.

We're keeping this promise. With our new disc-based ECOS (Extended Communications Operating System) you can perform functions such as data entry, remote batch, file manipulation, media conversion and local batch processing *concurrently*.

We're also announcing Key Entry Processing (KEP), a new hardware/software system that permits you to perform both local and remote data entry, file update and file manipulation operations on the 1600. You can pre-process and edit data at the 1600 through our new Model 1675 CRT key entry station, reducing the load on your host processor and helping trim line costs.

Plus, to support KEP we're offering a new language (REGAL) which helps our 1600 solve a wide variety of business-oriented data manipulation problems. Through REGAL, you can create your own key-entry programs for

source data entry, file manipulation and file update — all with surprising ease.

Additionally, executing under ECOS, our local batch processing capability will enable you to perform applications programs at the local 1600 site written in COBOL.

When will all this be available? Harris is already delivering ECOS based systems with local batch processing. Deliveries of KEP systems are also underway.

Keep your good thing going by specifying distributed processing from Harris. You'll find the performance and flexibility you've been waiting for, at a price per function that's more cost effective than anyone else can offer!

For more information, contact Harris Corporation, Data Communications Division, 11262 Indian Trail, P. O. Box 44076, Dallas, Texas 75234, (214) 620-4400.

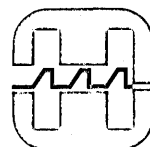

HARRIS

COMMUNICATIONS AND
INFORMATION HANDLING

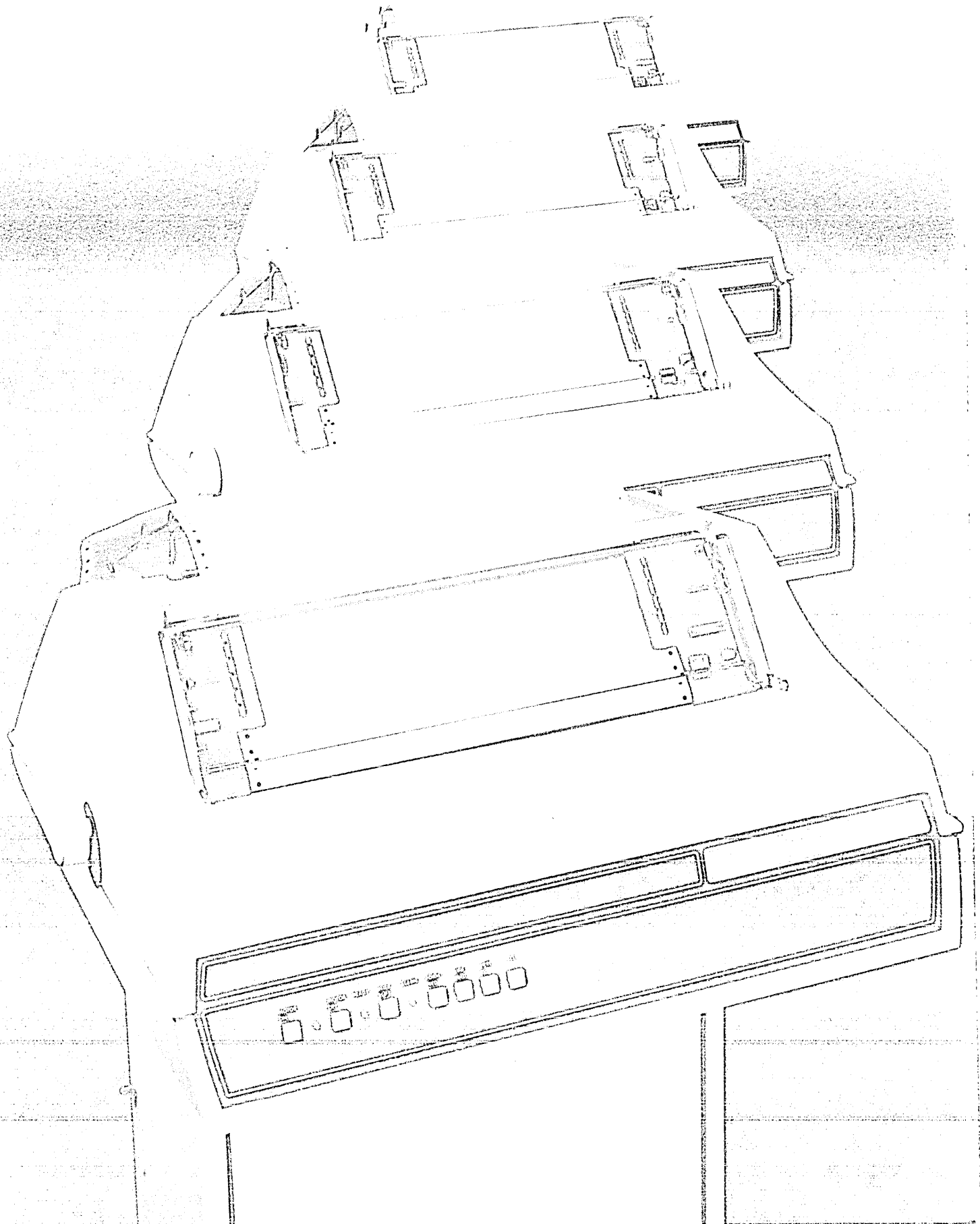

GE puts it on the line with a new family of TermiNet[®] line printers

Four value-packed true line printers with real 90-340 lines per minute throughput at practical, low prices

Small size. Compact design. Modern styling. Quiet operation. Low prices.

At the same time this new space-saving family of GE TermiNet line printers is big on performance. They're big on throughput. Gives you a range of speeds from 90 lpm to 340 lpm, depending on the number of printable characters per line and the size (64 or 96) of the ASCII subset. And that's *real* throughput (see graph).

They're big on reliability backed by years of proven electronics and rotating belt technology. (Over 75,000 GE belt printers installed worldwide.) Big on versatility. 67% of the parts are common to TermiNet 300, 1200 and 120 printers. For resellers this means a minimal spare parts investment. For users it means improved service and less downtime due to a lack of spare parts. You can modify or upgrade quickly and at modest cost. They're big on interfaces. Serial and parallel, buffered and unbuffered.

Big on quietness. They're a welcomed addition to any office or computer room. Big on value-packed features. Both front (recommended for multi-part forms) and

rear loading. 132 columns. Original and 5 copies. A unique ribbon cartridge. With a life span of 50 million print characters. Operators can replace in less than a minute. Easily. Cleanly.

And, they're big on troubleshooting. 14 light emitting diodes (LED's) located on the outside of five printed circuit boards quickly indicate malfunctions. A test button on the control panel provides rapid checkout of printer action. Staggered or "ripple" test patterns print continuously as long as TEST is activated.

This big new family of TermiNet line printers are *true* line printers.

In fact, the only thing you'll find small about this new family of line printers is their size and price. In these days of spiraling costs, GE is putting it on the line with practical, low prices. From \$3900 for the TermiNet 310 printer to \$5130 for the TermiNet 340 printer (user quantity 1). That could well be the best cost/performance in line printers available today.

Let us prove it. Write General Electric Company, TermiNet 794-17, Waynesboro, VA 22980.

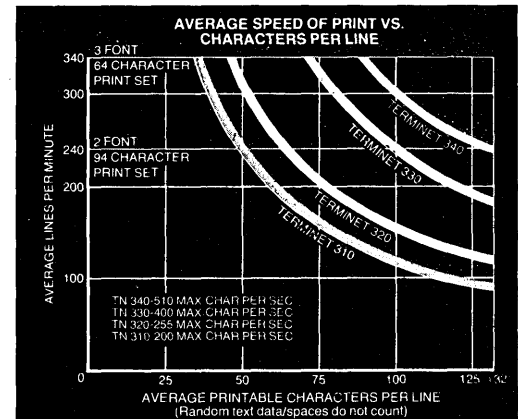

The print rate for TermiNet line printers varies with the number of printable characters per line and the size of the ASCII subset used. Analysis of the typical rate curve shows that TermiNet 340 throughput for the 64 character ASCII subset is an average of 340 lines per minute when there are 90 or fewer characters printed on a line. This includes one line feed per line. Minimum throughput is 231.8 lines per minute when printing characters in all 132 columns, faster if there are spaces in the print line.

For your special kind of needs-A special kind of printer

GENERAL  ELECTRIC

Graphic hardcopy output from IBM systems: the Plotmaster® makes it a reality, not a dream.

If you have an IBM System 360/370 computer operating under DOS, OS or VS, you know what a nightmare it is to get graphic hardcopy output.

That's why the Gould Plotmaster Systems are like a dream come true. They deliver crisp, high quality graphics output from the computer, with no intermediate processing steps. They also work at incomparably fast speeds, without demanding additional system resources. No hours or days of waiting as when you use a slow pen plotter attached to the computer. No waiting for post-processing film development and blow-up as when you use graphic microfilm units.

Plus, Plotmaster Systems are economical as well as efficient. Initial and recurring costs are surprisingly low. And fast turn-around and high capacity adds up to additional savings.

Plotmaster Systems have three major components. Efficient and flexible graphics software. A Gould electrostatic printer/plotter that you can tailor to your exact application. And hardware to link the two—an on-line controller, or a tape drive for off-line operation.

In addition to this basic package, specialized software is available for business, scientific and engineering applications. Full printing capability is optional.

Let us tell you more about the

fast, powerful, versatile Plotmaster Systems. They can be purchased or leased and are supported by Gould's specially trained service force.

For a free brochure, write Gould Inc., Instrument Systems Division, 3631 Perkins Ave., Cleveland, Ohio 44114. Or Gould Advance Ltd., Raynham Road, Bishop Stortford, Herts, United Kingdom. Or call Gould toll-free at (800) 325-6400, Ext. 77. In Missouri: (800) 342-6600.

 **GOULD**
The product development company

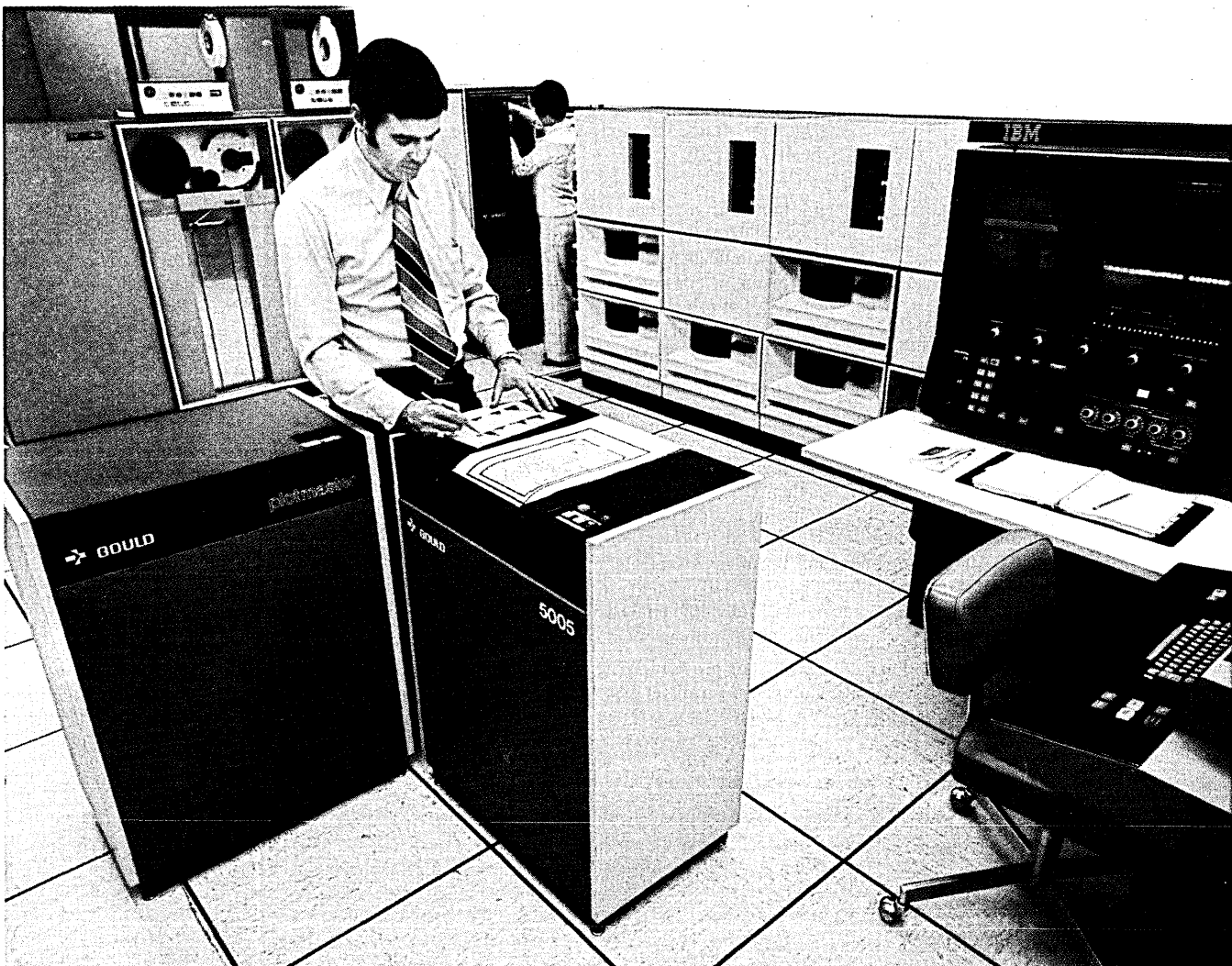

Ask CONTROL DATA about their full range of Engineering Services.*

They have them all.

- Installation and maintenance of CDC computer systems, worldwide
- Third party maintenance (non-CDC systems)
- Computer facilities site planning
- Design and construction management of computer centers
- Computer facility support services
- Worldwide parts & logistics support
- Refurbishment of both CDC and non-CDC equipment
- Radio and data communications maintenance
- Installation, test, and repair of medical electronic equipment
- Technical training for customers

*Control Data offers you a complete spectrum of maintenance agreement options and prompt, highly professional attention, tailored to your needs. Call CDC collect (612) 853-7600 for more information or write CDC, Box 1980, Twin Cities Airport, St. Paul, MN 55111.

 CONTROL DATA
CORPORATION

Distributed Processing

It's a Question of Experience

"I'm going to be very careful before I go the distributed processing route," sums up attitude of persons attending meeting on the subject

The subject was distributed data processing. And the topic drew some 170 people to a 3½-day seminar last month in San Francisco. It showed that many people are interested in possibly going to the new information processing environment, but the disappointment in the program expressed by many of them indicated that few people yet have enough experience with distributed processing to say what it's like.

Questions posed to the speakers by those in attendance showed a concern over control of those distributed processors. Who does all the applications programming for those remote computers? One of the few speakers who had implemented and was now operating such a system was James B. McLaughlin of Bergen Brunswick DataService Co., Carson, Calif. He said the programming must be done centrally. "You've got to maintain control and integrity of those systems out there," he averred.

But there was disagreement. Andrew H. Olson of the consulting firm of Cook, Robertson Assoc. Inc. in Los Angeles said people are going distributed because the remotely located users weren't getting the processing service they wanted. So, yes, they should be allowed to do their own programming. But there must exist a very strict set of interface standards so that anytime the user's data must become input to a centrally maintained system, the data must meet certain internal standards. Louis L. Davis of System Development Corp., Santa Monica, Calif., agreed. "There's no reason why a user, who uses it as a tool, cannot program his own system."

Standardization needed

Consultant Joseph T. Hootman of Saratoga, Calif., expressed it this way: "If it's a freestanding application, okay. If it casts a feedback to the central computer [such as payroll data], then you have to be careful because the output

from that processing must fit with the inputs from the other dispersed points. So there must be some standardization and control."

There was more agreement on the subject of security and privacy. The point made was that in a large central system, there tended to be many applications programs running in a large mainframe supporting many users, usually simultaneously. And it is difficult to control. But in a distributed processing system you typically have fewer applications running simultaneously, often only one in a minicomputer at any time. Thus it is more difficult for an outsider to penetrate the system without being detected.

The conference, under the sponsorship of the American Institute of Industrial Engineers, really raised more questions than it answered. But it wasn't all bad. On the final day, one of the attendees was heard to say, "I'm going to be very careful before I go the distributed processing route." He apparently learned something.

Nor was there a speaker who braved to define the concept. Leadoff speaker Karl Drexhage of Stanford Research Institute said, "For the first time we have the components that allow us to design and configure systems that ultimately are more responsive to user needs and more in tune with user requirements." He admitted there is a lot of confusion as to what distributed processing means, but said vendors are aware that it allows them to sell a lot of its components under one umbrella buzzword. But there has been pressure for decentralization too, he added, from users and from those at the central site.

"We have the ability now to pick processors and systems to fit not only the task at hand, but more importantly perhaps to fit the organizational structure," Drexhage said. "We can design systems that give user departments much of

their own processing capability, while simultaneously giving the corporate people a summary of that data for overall management (purposes)."

Distributed data and processing

The concept of distributed data processing, he continued, "is to place processing power at points where the data is generated or where the data is needed for supervision or management." Perhaps it should be called distributed data *and* processing, he commented. He also addressed briefly the distribution of the data base, saying it is a technique that has eluded the experts for a long time. "There is no good understanding or general theory as to how to distribute a data base," he said. "In point of fact, it is very application-dependent."

Designer's viewpoint

Most articulate on the subject, speaking as a designer rather than a user, was



GRAYCE M. BOOTH
No room for medium-scale computers

Grayce M. Booth of Honeywell Information Systems in Phoenix. She said the three components of a distributed pro-

cessing system are the microcomputer, minicomputer, and the maxi. She deftly defined them in this way: the micro is something that can be picked up by two fingers, the mini by two hands, and the maxi by two elephants.

"We've got basically three kinds of components," she said. "And quite frankly, speaking for myself and not for Honeywell, I don't think there's any room any more for medium scale computers. There is a place for large scale, there's a place for minis. What's happening is that they're growing together. The micros are moving up to the low end of the minis."

She also explained that there are two kinds of roles for the processors—the host and the satellite. "A large system isn't always a host, nor a mini always the satellite." She said she can imagine systems, although she didn't know of one, where the mini is the host and a number of large scale systems are the satellites. "The point is that a host is a computer that provides supporting services," the types of supporting services that a time-sharing user gets, whereas a satellite is dependent on the host for guidance.

Booth spoke of two types of distributed system architectures: horizontal and hierarchical. In the former there are logically equal components cooperating among each other, such that if one were to take away the communications facility that interconnects them, what one would have is a decentralized system. "This is the kind of system that's destined for resource sharing," she said. "If you have an overload at any one of these centers, you would like to shovel it off to another center."

They talk hierarchical

She said the design that most people are referring to when they talk of distributed processing is the hierarchical. This is where one finds minicomputers, a vertical distribution of functions and, often, unlike components. She described a production control system that consists of a maxi host with a central data base where production in a factory is scheduled. It's largely a batch operation, she said. At lower levels are satellite minis, each maintaining a local data base—that is, a working copy of part of the host's data base. At the next lower level, communicating with the minis above, are minis and/or micros that control production devices on the factory floor. In the hierarchy, she explained, you see specialization of functions, and as you go lower you see greater specialization.

Booth noted that conceptually such a system is no different from a banking system, in which the host maxi maintains central customer accounts, while satellite minis hold branch customer accounts and also control the teller terminals.

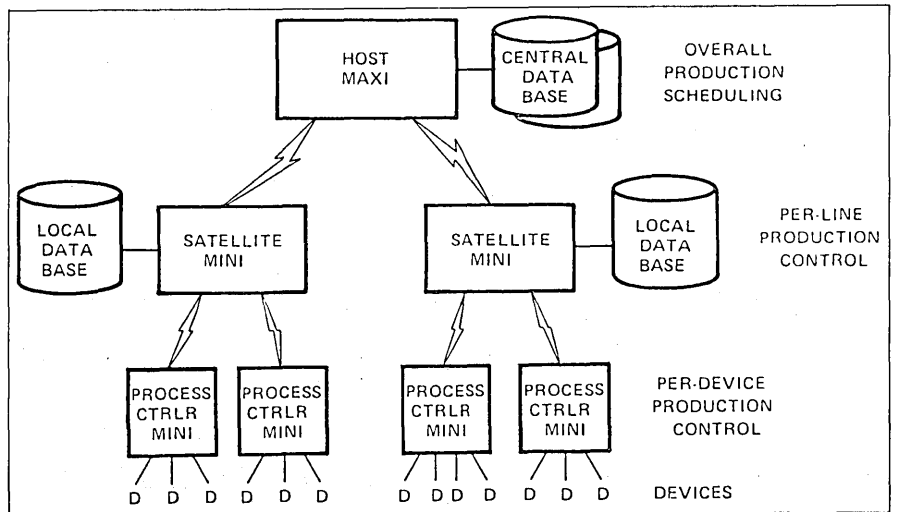

PRODUCTION control system with central data base and, at lower level, satellite minis with a copy of part of host data base. At next level minis and microcomputers control production devices.

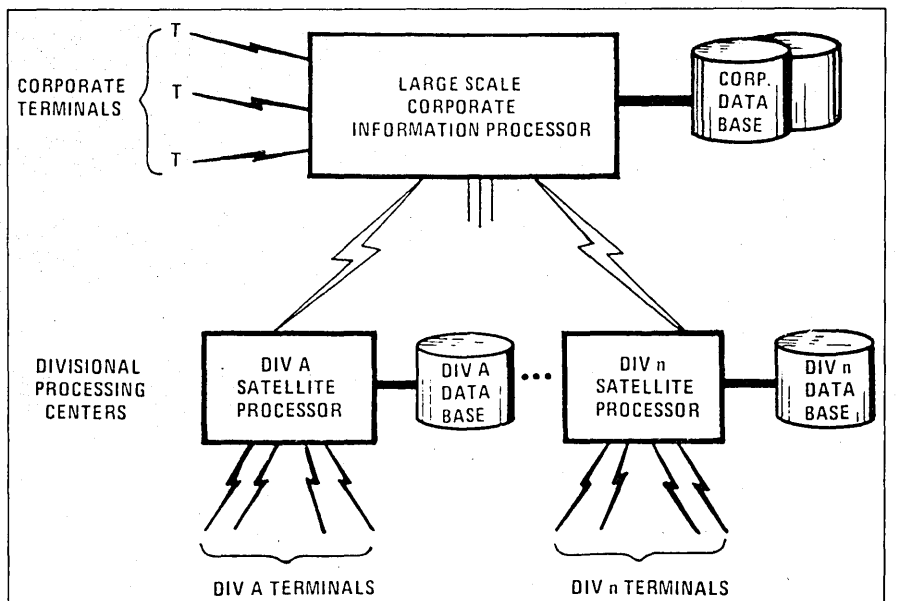

HIERARCHICAL partitioning: At corporate level, summaries of data from lower levels of a business are maintained and at divisional level there only are summaries from even lower levels.

"I think the centralization that the economies of scale dictated up to now in computing systems tended to force you to centralize the computer," Booth said. "And that's not the way organizations work; most of them are not that heavily centralized. You tend to get the organization of the computer facilities different from the organization of the enterprise that owns it. So you see problems of people unhappy with their computer system."

Partitioned or segmented

The speaker also categorized distributed data bases as either partitioned or segmented. The partitioned data base is one that is split up and distributed to different locations, thus getting the data out to where it's needed. There can be geographical partitioning, she said, as well as hierarchical partitioning, noting that partitioned data bases are "extreme-

ly unpopular. Everyone is afraid of them."

Hierarchical partitioning, she went on to explain, is usually handled with the duplication of data. At the corporate level, summaries of data from lower levels of the enterprise are maintained, and at divisional levels they have only the summaries from even lower levels. The idea is to maintain only one set of data, this at the location where it's used. And corporate people dip down to the divisional level to get the information they need for reports or summaries.

"The movement of large amounts of data is prohibitively expensive," she said. "So you have to learn to move information. And that's quite a quantum leap. You've got to know what information you want, move only that, and then your costs cease to be a significant problem . . . Then you must worry about the software needed to go back and forth

among these partitions, and here's where we run into the problems of standards and unlike computers and so on."

Booth, apologizing that she lacked the time to delve too deeply on any topic, said that in discussing distributed systems and protocols, "... the thing that's going to hurt us is not the communication protocol at the link level, which SDLC and HDLC are going to solve. Those are just tiny tips of a very large iceberg. It is much worse when you get to moving processes, moving data bases, communicating among unlike computer systems, and so on."

She admitted that she didn't know of any partitioned data bases, but did know of people working on the second type, the replicated. It's the easy way to a distributed data base, she said, explaining that it consists of a copy of all or parts of a data base at multiple locations.

Good and bad for security

Distributed systems, she concluded, are both good and bad for security, depending on what you're trying to do and what your situation is. "By splitting out pieces of data and putting them on separate processors, you can simplify the privacy problem by separating the sensitive data from the public data." The problem with putting everything in large systems, she said, is that there are different kinds of users and different kinds of data on the same system. "You're trying to apply different levels of security and privacy to them, and that makes life more complicated." She said that with a distributed system you can—though not always—place sensitive data on one system and public data on another.

Following a presentation by four panelists, a member of the audience commented that it seemed the function of distributing data is the last thing to be accomplished, whereas he thought it should come first. Honeywell's Gerald Nicklin, one of the panelists, said, "We can't begin to distribute the data across the network until we feel we're comfortable with what we call privacy and security. And along with that goes recovery."

He said the first step is to distribute the processing capability. The second step is what he called transaction processing, where he said you're not only controlling a process but you're controlling it with the message content that's going downstream. The third step is to see how data can be distributed so that the processing can be done at the remote site, where there's responsibility for the data. Only summary data is then transmitted to the central site.

"But you cannot distribute that data until you're very comfortable with privacy and security within that central

Medical

Computerized Scanners: Nearly All Larger Hospitals are Prospects

Distributed processing of sorts is entering the hospital environment by the back door. In a few hospitals, on-line terminals have become an accessible if not totally accepted medium for communications and data storage/retrieval among physicians, nurses, and technicians. But there's something catching on faster than the hospital-wide information system. A new minicomputer-based diagnostic tool that's the hottest thing in radiology is the computerized tomographic, or CT, scanner.

A CT scanner, using an x-ray beam, provides a cross-sectional view of a portion of the human anatomy. It overcomes the major shortcoming of a conventional x-ray image in which one organ is superimposed over another and where the density of a tumor, say, might vary only slightly from the density of the tissue surrounding it. It thus is often difficult to distinguish one from the other.

A scanner-produced image, instead, provides the type of view that would result if one could slice the body at the waist, for example, and look inside at the exposed organs. A scan of the chest area would show the ribs as white dots around the periphery of the oval-shaped image, within which are the various organs.

No more injections

Using this technique, first developed in 1972 by EMI Ltd. of England to scan the head, medical diagnosticians have at their disposal what is termed a noninvasive method of studying a patient's

site, much less outside the central site," Nicklin said.

The topic of protocols and standards, or the lack of same, arose in a number of presentations, but little was said about upcoming developments in data communications. Robin Ollivier of Educational Data Systems tried to field this question. He said, "I think what you'll see is more common carriers coming into the market with things like waveguides and fiber optics and bouncing things off satellites."

Whereupon the man who raised this question retorted with: "Will we be seeing those things about the same time we see the standardization of communications links?"

—Edward K. Yasaki

condition. It gets around the hospitalization of a patient, perhaps the injection into the blood stream of some contrasting medium to highlight an area of interest, or even exploratory surgery. It promises to reduce drastically the use of such procedures as the injection of a radioisotope into a patient's bloodstream, an experience that is none too comfortable and, indeed, can be traumatic.

In CT scanning, the x-ray source is made to rotate around the body of the patient. Opposite the source, on the other side of the patient, is an array of detec-

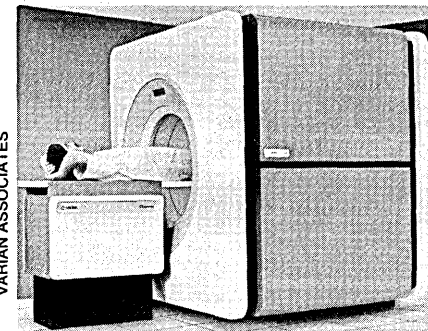

SCANNING promises to reduce drastically such painful procedures as injection of a radioisotope into a patient's bloodstream.

tors that rotates along with the source. The detectors measure the intensity of the beam that has passed through the body, a value that varies with the density of the structures through which it

A scanner produced image provides the type of view that would result if one could slice a body at the waist and look inside.

has passed. The devices then increment by one degree and the procedure is repeated. At the end of 180 degrees of rotation in the case of some systems, or 360 degrees in others, the data for one slice has been accumulated.

It may require from five to 20 slices per patient, depending on the problem under study, but during that time the patient must only lie still and perhaps hold his breath for the duration of one scan. He receives at that point more radiation dosage than he would get from a standard chest x-ray picture-taking session. "For the procedures it typically

is replacing, however, it is giving less radiation to get, typically, even more information," says Ted J. Cooper, physicist at Varian Associates, Palo Alto, Calif.

Data stored in mini

Varian's scanner, currently under development, takes the data generated by the x-ray detectors and passes it through an analog-to-digital converter on its way to a Varian V76 minicomputer. On each 360 degree rotation, which takes six seconds, more than 108,000 x-ray intensity measurements are taken. The mini, in the data gathering mode, stores the data, in the form of 108,000 16-bit words, on a hard disc. The data rate from the scanner is about 800,000 words/second.

When the scanning is completed, the mini has the task of helping reconstruct pictures of the slices, a process that takes about two minutes per picture. It is a complex procedure that requires between 200 million and 300 million multiplications per picture and three or four times as many additions and subtractions. Thus Varian uses a hardwired device called a back projector, along with the mini, to mathematically compute the loss of photons at each point along the ray's paths through the body.

The hardwired device takes a row of information from a single exposure and places it in the form of a matrix of numbers, each number representing the x-ray intensity level at various points in the cross section. It is fed this information by the mini in the same sequence as the exposures were made, and then must compute how the numbers should be figured in to the picture that has already started to form.

It proceeds to add numeric information from subsequent exposures, modifying the density estimates until all 360 exposures have been considered and the density values have ceased to change. The resulting matrix, which can be as large as 256 x 256 elements in size, becomes the picture, and the values of the numbers at each position determine the intensity of the output on the crt.

The use of 16-bit words coming off the scanner and the collaboration of a hardwired device with a mini that handles 16-bit words is credited with the speed at which image reconstruction occurs. It purportedly would be no faster if they used a maxi computer with a megabyte of memory, instead of the 64K mini. "By dedicating repetitive calculations to hardware units in parallel computation paths and by using 16-bit words," says Cooper, "one can realize huge savings over conventional methods."

Every hospital a prospect

CT scanners are priced at a minimum \$400K each, and yet there's such a large market for them that some 18 companies have, or are coming out with, a

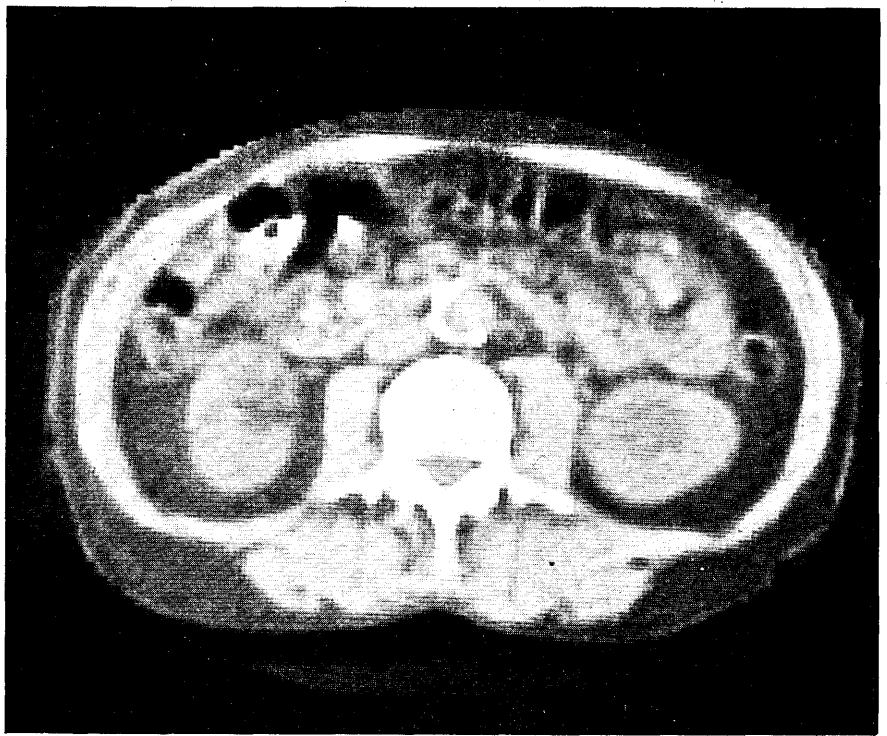

CT SCAN: Photo produced by a 360-degree scan and displayed on a crt. White blob in bottom center is spinal column. Rectangular gray pieces next to it on left and right are muscle. Round shapes to left and right of muscle tissues are the kidneys. Below the spinal column and forming an oval outline is more muscle tissue. Directly above the spine, the small round object with some white showing up at its periphery is the aorta (the major blood vessel from the heart). The white is calcium that has begun to deposit around the outside. Remainder of the gray shapes are the intestines. Black shapes around the top are gas in the intestines.

model. Marketers believe that every hospital with 200 beds or more is a ripe prospect, one market study projecting installations of almost 4,000 units by 1980.

"The market for these machines would not be so great were it not for the minicomputer," says Varian's CT product manager, Lewis Meyer.

In Varian's system, the mini serves as a system supervisor, aiding the technician in setting up a patient for a scan and the parameters of a scan, as well as capturing such information as the patient's name and the date. It supervises the scan and the data gathering process and the subsequent data management task, plus keeping records of stored pictures. It also responds to requests for the display of pictures, for a zoom image of a picture, which is produced with the assistance of the back projector.

With early scanner systems, such as those produced in England by EMI, the user was discouraged from using the mini except as an integral part of the system. More recently, however, as in Varian's system, the mini is also available to the radiology staff at the using hospital for the production of statistics and the compilation of new programs. It is another illustration of the extent to which the end user increasingly will be programming his own machine.

—E.K.Y.

Electronic Funds Transfer

It's Wells Fargo to EFT for SBC

Control Data's Service Bureau Corp. has joined the swelling and varied ranks of companies trying to cash in on electronic banking.

SBC has agreed to purchase from Wells Fargo Bank of California some computer programs and business procedures connected with its WellService, a transaction verification system which handles check approval on checks drawn on any California Bank and credit card approval.

The Wells system uses both TRW and Texas Instrument terminals installed in hotels, restaurants, department stores, and automobile dealerships. The terminals are linked to the bank's own data base and to Telecredit, Western States Bank Assn. and TRW's Validata. First announced in June of 1975, the service had grown last month to a 460 terminal system.

Service Bureau Corp. will market similar systems to financial institutions across the country on a turnkey basis. It is calling its version Telemoney.

Wells Fargo charges merchants an installation fee and transaction fees

news in perspective

ranging from 4¢ to 7¢ per transaction. Total monthly charge ranges from \$60 to \$70.

The competition

SBC will be competing for banks' business with the two major bankcard systems, National BankAmericard, Inc. and Interbank's Master Charge and with another new, in a sense, entrant, American Express Co.'s subsidiary, Payment Systems, Inc.

Payment Systems is hardly new to electronic banking. It has long been active in the electronic funds transfer (EFT) arena in consulting, research, and with workshops and symposiums. Now it is talking to savings banks about offering a complete system it describes as a "new payment vehicle" linked to merchant sites. In mid-August the system was still in "the definition stage."

Issuance by banks of debit cards, cards which cause funds to be immediately transferred from a consumer's bank account to a merchant's, lags behind transaction verification systems largely because most banks seem to want their own.

The two major bankcard companies have announced debit cards but they haven't been received with outstanding success. NBI's Entrée card was an-

nounced last fall but only some 200,000 cards are out and only in five markets. Interbank's Signet card is not expected to appear until late next year.

And neither are truly debit cards. Entrée works very much like BankAmericard. Each purchase produces an imprinted piece of paper. When the merchant turns the paper over to the bank, then the cardholder's checking account is debited for the amount. The merchant pays a similar discount as with a BankAmericard purchase and any store which takes BankAmericard must take Entrée as well.

Not as much

Interbank's Signet doesn't do as much. It will merely guarantee checks written to merchants when it makes its debut. Ultimately, though, Interbank hopes Signet will become a true debit card and will effect the immediate transfer of money when it is used.

EFT leader Citibank, the second largest bank in the world, is one of 1,300 U.S. banks which issues Master Charge but is in the debit card arena on its own. It has Citicard. Wells Fargo, First National Bank of Boston, and First National Bank of Atlanta also have their own debit cards as do numerous savings

banks and groups of savings banks.

NBI is going beyond BankAmericard and Entrée and is developing a national

The ABA says the number of banks offering credit card plans has jumped from 100 in 1955 to more than 14,000 today.

check guarantee service which it says it "may" offer in addition. The firm said several objectives have been set which it expects will be incorporated into the service. First, it will be based upon a card that can be offered by members to all deposit customers. Second, it will be used to obtain cash at selected merchant locations which elect to provide that service.

It will operate compatibly with a complete range of bank services in a terminal environment, NBI said, and it will utilize unique service marks so that merchants may selectively participate in check guarantee service, traditional bank card service, or both. Participating members will have the option of offering it as a completely separate service, as an addition to a local bank card of any type, as an addition to BankAmericard, as an addition to Entrée, or any combination of the four.

NBI said it expects to make a decision on offering the service by the end of the year. "Most of the work necessary

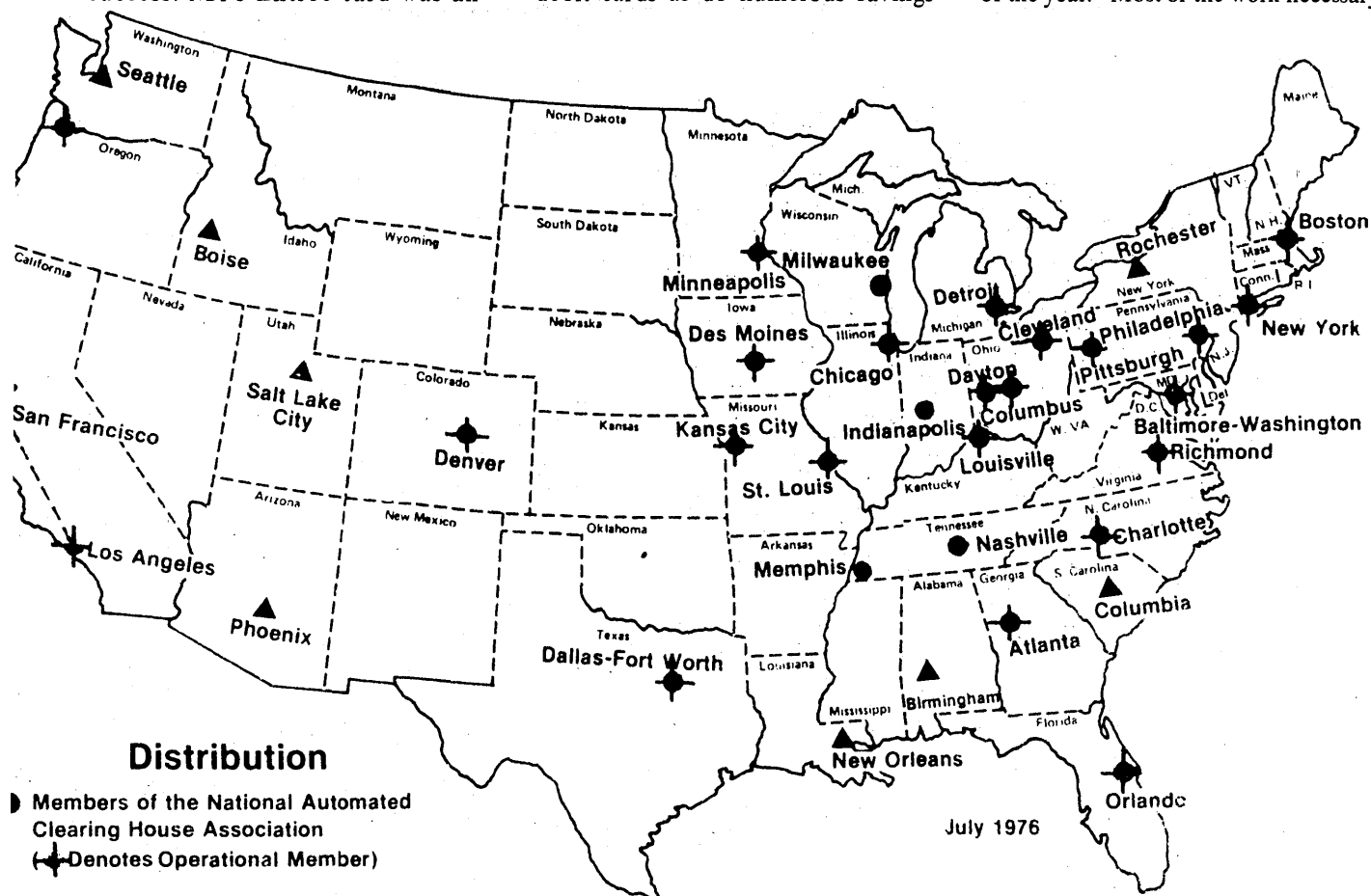

STOP

WAITING ON OUTPUT FROM YOUR MINI

You Are Wasting More In Dollars For Human Resources Than This LINE PRINTER Costs

2400 LPM - 80 COL.
MODEL 8210 - \$3000*

1400 LPM - 132 COL.
MODEL 8230 - \$3785*

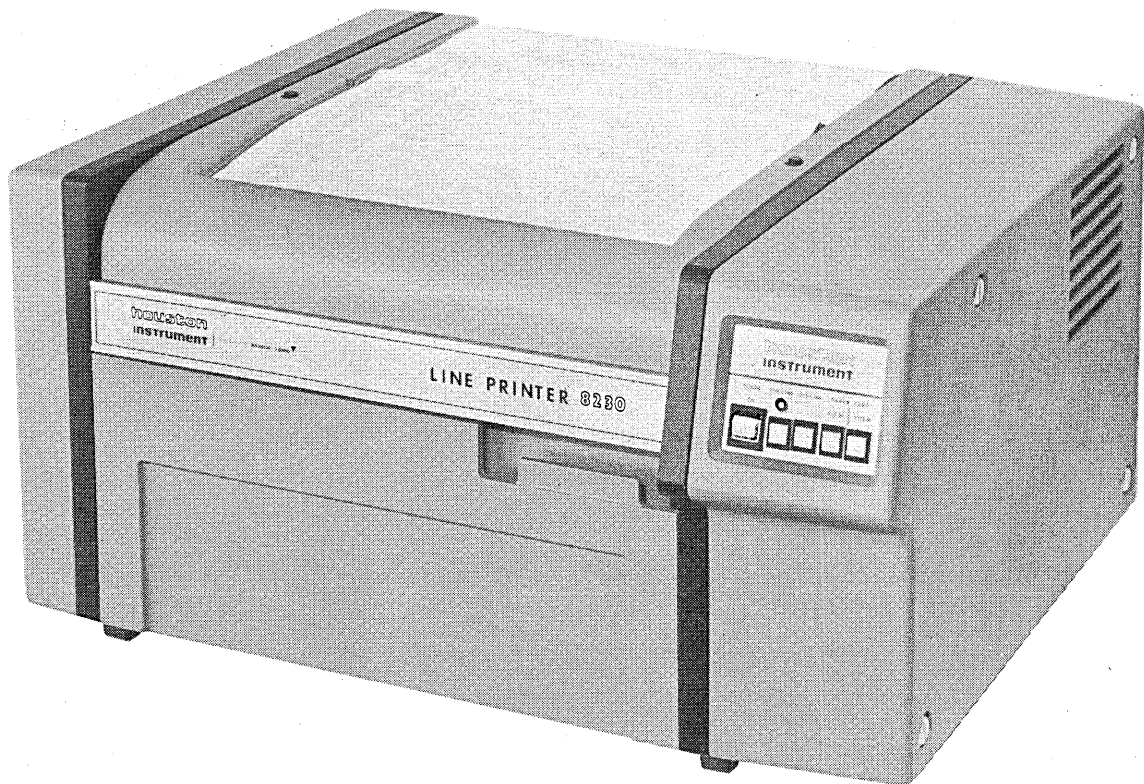

POWERFUL - A core dump from a 65K byte mini may be done in 30 secs.

QUIET - The rustle of paper and the cooling hum are the loudest noises you'll hear.

FOR ORDERING
INFORMATION
CALL OR
WRITE

**houston
instrument**

DIVISION OF BAUSCH & LOMB 

ONE HOUSTON SQUARE (at 8500 Cameron Road) AUSTIN, TEXAS 78753
(512) 837-2820 TWX 910-874-2022 cable HOINCO

EUROPEAN HEADQUARTERS Rochesterlaan 6 8240 Gistel Belgium
Phone 059/277445 Telex Bausch 81399

* Domestic USA Prices, Qty 1, End User

news in perspective

before a decision can be made relates to marketing and operations," said NBI president, D. W. Hock. "The basic data communications systems are already built, paid for, and operating successfully. Our BASE I authorization system has been providing merchants with authorization service either through message switching or negative file 24 hours a day, seven days a week, for more than three years."

Hock added that NBI's BASE II systems have electronically exchanged and settled value data on all transactions inter-

changed between member banks for more than a year and a half.

"Both are proven systems serving both BankAmericard and Entrée issuers and capable of continual modification to handle new services and increased volume. Both have duplexed computers. Plans for duplicating the physical location elsewhere, depending on need, have been on the shelf for more than a year."

NBI expects to expand its BASE II value transmission system worldwide by early 1977. A key feature of the expan-

sion, the company said, will be inclusion of 60-day currency conversion tables permitting the BASE customers to make individual currency conversions for each transaction as of the date of deposit. The system will utilize dial-up satellite telephone circuits, a procedure NBI has been using for domestic traffic with Alaska for more than a year.

The bankcard company extended its BASE I authorization system world wide in December 1975, when international members began providing electronic data on lost, stolen and blocked accounts to BASE operations. The file is distributed to members weekly on magnetic tape or microfiche enabling U.S. cardholders to obtain authorization in any host country without concern about whether the authorization center of their issuing bank remains open. Merchants in the U.S. can obtain authorization for foreign visitors 24 hours a day, seven days a week.

NBI has set up committees among its member banks to work on its proposed new service.

New is in

New is the name of the game in EFT. Almost every day a new company gets into the act, new legislation is passed, and/or new statistics are released.

The American Bankers Assn. has released some interesting "new" statistics. The number of banks offering credit card plans, says the ABA, has jumped from 100 in 1955 to more than 14,000 today. The association says the transaction volume for the two major bank card companies, which was a mere \$6.8 billion in 1970, was \$18.3 billion in 1975.

The ABA polled marketing executives of banks with assets of more than \$100 million. Among the results: 86% of them expect their banks to offer debit cards by 1980.

The National Automated Clearing House Assn. last month said that automated clearing house volume has finally passed the one million mark. The latest monthly volume figures from the 23 operational ACH's totaled 1,200,947 credits and debits. Four remaining, non-operational NACHA members are projecting they will be in business by the end of this year.

But setbacks continue. In Chicago, EFT pioneer Continental Bank lost a skirmish in its continuing war against Illinois' unit banking laws and the impediment those laws have been to its EFT efforts. A bank supported community banking ordinance passed by the city of Chicago, permitting expansion of banking facilities including remote automated teller units, was shot down by Federal Judge Raymond Berg.

Continental reacted. Senior vice president William D. Plechaty called Judge Berg's ruling, "a setback for the people of Chicago."

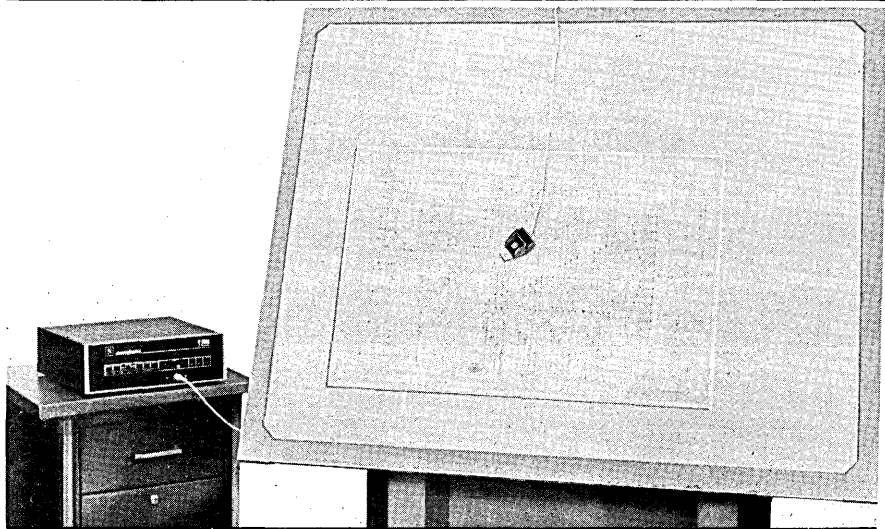

Summagraphics® ID*

The latest advancement from the leading supplier of low-cost

data tablet / digitizers

*ID: Intelligent Digitizer

with the

Built-in Microprocessor for

- self-calibration, permitting high accuracy/ high linearity
- re-locatable origin
- stand-alone operation in many applications, for calculations such as volumes, areas, linear displacements, perimeters — and any others for which our programmers stand ready to develop the software.

Operating Modes: our usual Point, Stream and Remote — and now, each also operable Incrementally.

Cost/Performance Factor uniquely favorable, as with the 4000 other Summagraphics units now at work in business, cartography, engineering, geophysics, medicine, publishing, science... and MORE:

For details, and list of users, write or phone



Summagraphics®
corporation

35 Brentwood Ave/Box 781
Fairfield, Connecticut 06430
203-384-1344

"Obviously," said Plechaty, "part of our disappointment . . . stems from our interest in bringing banking closer to the people in convenience and efficiency of service. But in this instance, Continental's interest and the people's interests are parallel, for consumers have a right to expect convenient access to banking services."

Chicago is underbanked, he said. "The per capita ratio of banks to people in Chicago is about 1 to 30,000, and many Chicago neighborhoods have no banking representation at all." This compares to New York City or Los Angeles, where there is one full-service banking office for every 5,600 people.

Continental, said Plechaty, "has consistently supported the multiple-office and electronic banking concepts, and we will continue to work to make both a reality. We intend to respond as best we can to the emphatic demands of small business and the personal banking consumer for more convenient, more versatile, more satisfying service."

Ironically, RoseMary Butkovic chose Illinois, a unit banking state, for home base from which to make a survey of existing remote electronic banking terminals. Butkovic, formerly with Payment Systems Inc. and now an independent EFT consultant, decided to make her survey because "most of the figures bandied about today deal with projections for the future." She stuck to what is in place right now.

770 banks

She queried 770 banks known to have the remote units installed based on general knowledge and applications from commercial banks to the Comptroller of the Currency and from savings banks to the Federal Home Loan Bank Board.

"There are approximately 8,000 electronic terminals performing a variety of banking and authorization transactions at non-branch locations, and the total is growing rapidly," she concluded.

The terminals, she said, are installed in shopping centers, retail stores, offices, airports, and other locations throughout the country. Some 80% are being used for credit authorization and check verification or guarantee at point-of-sale (POS) locations and another 15% offer electronic banking services at merchant locations. The remaining 5% are automated teller machines at locations other than bank premises.

Butkovic said more than 500 financial institutions in 44 states and the District of Columbia are offering their customers electronic banking services at remote merchant terminals and automated teller machines. "Financial institutions as small as \$30 million in deposit size have installed electronic terminals for EFT services," she said. "Such services include deposit taking, withdrawals, transfers, and authorizations for check cashing and credit cards."

In the next year

More than 9,000 additional terminals, she said, are planned for installation over the next year or so, more than doubling the number installed today. "Approximately 75% of the new terminals are expected to be for credit authorization and check verification or guarantee service."

Butkovic said responses to her survey indicated that the number of transactions performed by remote terminals range from less than 100 a month at a POS terminal to more than 5,000 a month at an ATM. On the subject of privacy, she said, "most respondents indi-

cated that they controlled access to the customer account information by issuing personal identification numbers (PINs) or codes, restricting card issuance, maintaining activity and dollar amount controls on withdrawals, and by providing technological safeguards to prevent unauthorized access to account balances."

And, apparently, EFT still looks good to AT&T. Ma Bell, which already has its Transaction Network Service up and running in the state of Washington (August, p. 105) has applied for a tariff in Minnesota.

—Edith Myers

Let us show you the drawing power of HP's computer plotters.

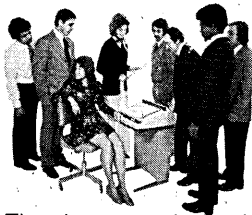
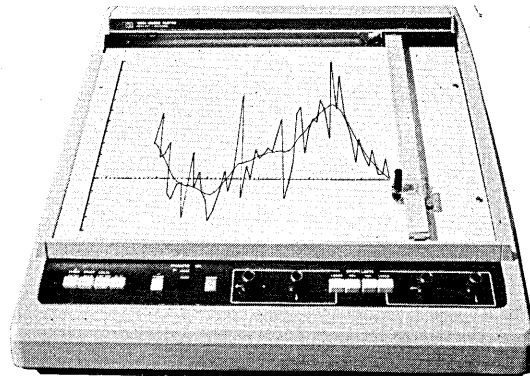

Our Graphic Plotters always draw a crowd when they start to work. Everyone around is quick to notice how the plotter reduces stacks of computer data into meaningful charts and graphs.

The plotters work wonders for electronic and mechanical designers. And sales managers, financial people, researchers, chemists or anyone else who uses data from a computer, time-share terminal or computer-operated measurement system.

With a minimum of software, they let you have graphics for engineering, research, marketing and financial problems. On any size paper up to 11 x 17 inches (28 x 43 cm). In red, blue, green or black.

And prices start at just \$3750 (domestic USA price).

For more information on why HP's Graphic Plotters are a top drawing item, write: Hewlett-Packard, 16399 West Bernardo Drive, San Diego, CA 92127. If you wish, you can have a live demonstration just for the asking. Then draw your own conclusions.

11607

**HP Graphic Plotters. Built for times
when a fine line separates success from failure.**

HEWLETT  PACKARD

Sales and service from 172 offices in 65 countries.

news in perspective

Mainframers

CDC: Big in Services —But in Systems too

Computer services are a big thing at Control Data Corp. these days, but the company continues to forge ahead in computer systems development.

First, there's the string array processor, the STAR 100. Two are installed at the Lawrence Radiation Laboratory in Livermore, Calif., and a third is being added this month to the company's Cybernet services network. The powerful processor is being upgraded: the STAR 100 A will be given a new memory to upgrade its scalar performance and the STAR C is being configured more compactly and will have 2 to 30 times the power of a CDC 7600, depending on the function.

Next, says John V. Titsworth, CDC's vice president for systems, is a successor to the Cyber 170 line, introduced two years ago. The first LSI prototype is being switched on next month in Minneapolis. That product will be an outgrowth of the five-year CDC and NCR joint project to develop an advanced line with a common architecture.

"That joint project has been completed and now we'll go our own way to implement the architectural definition," says Titsworth. "We feel we've passed the first stage successfully. The first machine is to be turned on in October."

(A spokesman for NCR Corp. said his company didn't want to discuss its future product strategy. He said, however, that any new line would be software compatible with NCR's current offerings.)

The grand strategy in the joint development project was for CDC to develop large machines and for NCR to follow its traditional role of smaller machines. That may be the case. Titsworth said "CDC could buy from NCR products on the lower end."

Evolutionary

The new CDC line will be compatible with the Cyber 170 models. Conversion at that scale is "prohibitively" high, says Titsworth. "The customer can't afford it and the vendor can't afford it. There has to be a sharing of costs (with users) in such a conversion." CDC will add software and hardware to the 170 offerings over a period of four to five years and "then it will all be new," Titsworth said, calling the new line "evolutionary." However, it could be named the Cyber 180.

In spite of the system development efforts at CDC, Chairman William

Norris bubbled with enthusiasm over the company's prospects in the computer services business during a talk in late July to the New York Society of Security Analysts. His 3,000 word speech about Control Data's position five years hence contained only 200 words about future computers.



CDC'S WILLIAM NORRIS
Bubbling over services

He said that services which contributed about \$450 million to CDC's 1975 revenues of \$1.9 billion will approach \$1 billion in 1981. That would be about a third of CDC's overall revenues, up

Retailing

First it was UPC, Now it's UP\$

A relatively new company in Greenville, South Carolina, may do a lot to cut down consumer resistance to the grocery industry's Universal Product Code (UPC).

The resistance has centered on the UPC being used instead of rather than in addition to item price marking. Some states have legislated against this.

The new firm, Universal Product Dollars Inc., might just make consumers take a couldn't-care-less attitude toward item pricing. It has a UPC of its own which can mean cash for consumers.

It was a brainchild of the company's president, Tom Greer. He got the idea when, as president of Texize Chemical Co., a company which produces such products as Fantastic (a wall cleaner) and Spray 'N Wash (a pre-wash spray), he was a member of the Universal Product Code Council. The council was made up of both retailers and suppliers who would be source marking products sold in supermarkets with the UPC.

Greer liked his idea so much he re-

signed from Texize to form Universal Product Dollars Inc. The company has been developing its program for more than a year. It was announced July 1 and will be test marketed in Southern California until early 1978 when it is scheduled to go national. "This schedule could be accelerated," said Alan Rudder, company controller.

from 24% last year. This year, he said, computer services will rise about 12% to about \$500 million.

Breaking down the firm's business into its four major components, Norris said financial services through its Commercial Credit subsidiary last year contributed 35% of combined computer and financial revenues. Computer systems contributed 24%, as did the services business. Computer peripheral products contributed 17%.

In 1981, he predicted, the breakdown would be one-third from computer services, one-third financial services, with the remaining one-third equally divided between computer systems and peripheral products.

His reasons for concentrating on the services business:

—It has been one of the principal growth areas of the computer industry, and is expected to continue growing at a minimum of 15% a year;

—Control Data already has a strong foothold in the market as the leading data services supplier in terms of volume and breadth of applications;

—It has high profit potential and greater return on capital employed;

—There is a critical need of industry and the education system to improve efficiency which can best be accomplished by computer services.

Norris, noting that the service business has grown at an annual average of 20% a year, estimates that worldwide, it's a \$6 billion market. And Control Data has 1/12 of it. Plenty of room to grow.

—Tom McCusker

signed from Texize to form Universal Product Dollars Inc. The company has been developing its program for more than a year. It was announced July 1 and will be test marketed in Southern California until early 1978 when it is scheduled to go national. "This schedule could be accelerated," said Alan Rudder, company controller.

Answer to coupons

What it is is an answer to those "cents off coupons." Participating product suppliers source mark with a Universal Product Dollars bar code instead of their usual UPC. The UPD code is 15 digits, five more than the UPC. The first ten, Rudder explained, are the regular UPC information. The last five are for UPD and contain information from which the company can provide its participating suppliers with a wide variety of sales data including breakdowns of product move by zip code. Rudder said in-store scanners cannot read the last five digits but their scanners can read all 15.



BRAM THE
1,000 ARK

ON-LINE
AMDAHL 470 • BATCH QUERY LANGUAGE
SIEMENS 4004 • UNIVAC 70/90 • TOTAL INTERFACE • EXTENDED FILE PROCESSING
IBM 360/370 • IMS INTERFACES • IMS TRANSACTION PROCESSING • GENERALIZED SYSTEMS INTERFACE
QUERY/DC • EXTENDED TRANSACTION PROCESSING • ESP
TABLE LOOKUP • INDEXED COORDINATED FILE PROCESSING



We've helped
change the world of
data processing
— but one thing is the same

When we introduced MARK IV as a File Management System in 1968, we had some traditions to overcome— such as “free” software and the “not-invented-here” syndrome.

Now after 19 major releases, over 2,000 improvements and enhancements and more than 1,000 user sites, MARK IV is referred to as “The highest level language” by people who know.

MARK IV has changed considerably. In fact, we have outgrown our old name and, as “MARK IV Systems,” we help more industries in more ways in more countries in more operating environments than any software product. Period.

But one thing has not changed— we can still save you 60 to 90 percent on your programming costs.

informatics inc

Informatics Inc. System Products

21050 Vanowen St., Canoga Park, Calif. 91304
Offices in Atlanta, Chicago, Dallas, Los Angeles,
New York, Washington, D.C., Toronto, Canada

Informatics S.A. Geneva, Switzerland
267, route de Meyrin, CH 1217 Meyrin 2
London, Paris, Dusseldorf,
Copenhagen, Stockholm

Computer Applications Co., (CAC) Ltd.
Chiyoda-ku, Tokyo, 101 Japan

Datec Pty. Ltd. Australia
Sydney, Melbourne, Brisbane

Systems Programming (Pty.) Ltd.
Johannesburg, South Africa

news in perspective

How does the consumer benefit? When he buys a product with the UP\$ symbol, he cuts it out and saves it. Each symbol has a worth—from 5¢ to 50¢. When he has 50 or more he sends them in to Universal Product Dollars' processing center in Dallas in a postage-paid envelope and receives a check for the total value of his coupons. If he wants he can also play "match up." Universal has been running ads in consumer magazines which contain copies of the symbols which, when matched up with one on an actual product, double that symbol's worth.

Universal Product Dollars worked with National Share Graphics Inc. and Systems Research Co., both of Dallas, in developing the data processing required for its program. National Share Graphics is handling this now on a sub-contract basis.

The company is testing both stationary light pen scanners and laser scanners with its Southern California pilot program. As copies of the symbol which can be anywhere from .8 in. square to 1.0 in. square are received at the Dallas processing center they are fed into a metal chute equipped with wheels which kick them to the scanner, one at a time. The data is captured from the scanners on an Interdata minicomputer.

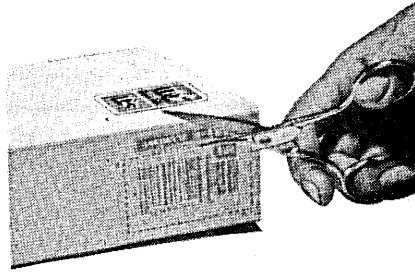

CLIPPING FOR CASH
A variation on the Universal Product Code

Tapes from the Interdata machine which ultimately generate checks for the consumer and reports for the manufacturers are processed on a University Computing Corp. Univac 1108.

Big ad budget

Just for its Southern California test operation, the company has an advertising budget of \$2½ million. Rudder said this is supposed to assure that they will reach 90% of consumers in the Southern California market more than once a week. Promotion includes radio and television spots and a broadside type flyer which appeared in 15 Southern California newspapers in mid-August. But even

before that, copies of the symbol were being received in Dallas and checks were going out.

Universal Product Dollars' agreements with suppliers are exclusive. "If we take one peanut butter," said Rudder, "we can't take on another but they have to make a minimum commitment to us." He explained that front end charges are based on the manufacturers' estimates of their sales volume. After that they're charged per symbol processed.

Rudder said the firm had some 15 manufacturers signed up by the end of July, between 50 and 60 by the end of August, and expects to have more than 100 by the end of this month. "With that many," he said, "the average consumer should be able to easily accumulate 50 symbols in one month without even trying."

The company's colors are green, white, and black but Rudder said the bar code can be any color without affecting scannability. UP\$ furnishes participating manufacturers with film masters for the symbol. The fledgling firm has ten employees, mostly in management. Such things as data processing, advertising, and public relations are handled by outside contractors, Rudder said.

Maybe they'll obsolete discount coupons.

—E.M.

Computer Scheduled MAGNETICALLY

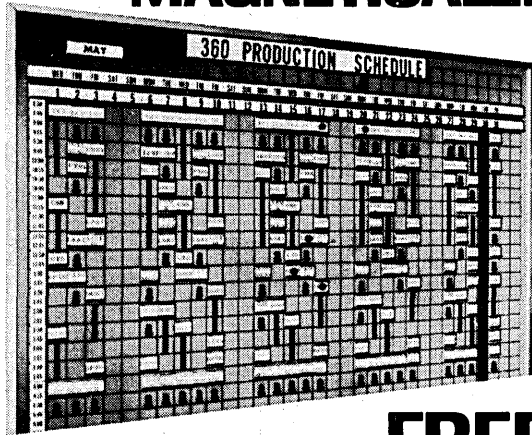

Write for 16 Page Illustrated Catalog **FREE**

- Keep your computer running—not idle.
- Schedule in 6, 10, 15 & 30 min. cycles, for daily, weekly or monthly periods.
- Know in advance when slack periods or heavy work loads are coming.
- Make changes & additions immediately.
- Every hour saved saves you \$20-\$40-\$60.

Representation throughout most of the United States
TELEPHONE 201-938-6000

METHODS RESEARCH

70 Asbury Avenue, Farmingdale, N.J. 07727

CIRCLE 137 ON READER CARD

SOFTWARE you need to know about

- RPG/RPGII TO COBOL TRANSLATOR
- OS JCL GENERATOR (JOL)
- TOTAL DATA BASE UTILITY (TDBUTIL)
- TAPE LIBRARY MANAGEMENT SYSTEM (LIBMAN)
- SIMPLE BLOCKED ACCESS METHOD FOR RELATIVE RECORD BDAM DATASETS (SIMBA)

The RPG/RPGII to COBOL TRANSLATOR is installed at many companies in Europe, Canada and the United States. Make your conversions easy. This translator is top drawer.

JCL (Job Organization Language) provides a very high level language for writing IBM 360/370 OS Job Streams. COBOL and PL/1 made it easy to write application programs; JCL makes it easy to write JCL.

TDBUTIL (TOTAL DATA BASE UTILITY) — Load, unload and reorganize any TOTAL data-base through simple keyboard parameters.

LIBMAN is a Tape Library Management System for the data processing man who does not want his operating system ZAPPED. If you cringe when a vendor wants to put 1401 type patches in your operating system or tear your hair out because your new release won't work without extensive vendor support, this system is for you.

SIMBA saves you valuable Disk space and improves program run time significantly by handling relative record BDAM datasets in a fixed block mode. Basically, SIMBA is a blocker/deblocker interface between your application programs and BDAM.

CIRCLE 115 ON READER CARD

(312) 296-2924

Write or Call:

CHICAGO BRANCH
SUITE 251
2720 DES PLAINES AVENUE
DES PLAINES, ILLINOIS 60018

(414) 351-2600

MILWAUKEE BRANCH
SUITE 6
8707 N. FORT WASHINGTON ROAD
MILWAUKEE, WISCONSIN 53217

DASD
CORPORATION

SPACE FLIGHT Operations Facility at California Institute of Technology's Jet Propulsion Laboratory during activity associated with the Pioneer 10 Jupiter fly-by and the Mariner 10 Mars mapping expedition that discovered Mars to be a relatively interesting place to visit. The nerve center of JPL's Deep Space Network, its walls currently are covered with timings and pictorial representations of various events associated with the two Martian flights. On the periphery are the offices of support personnel, most with more than one crt monitor to help keep them apprised of mission progress.

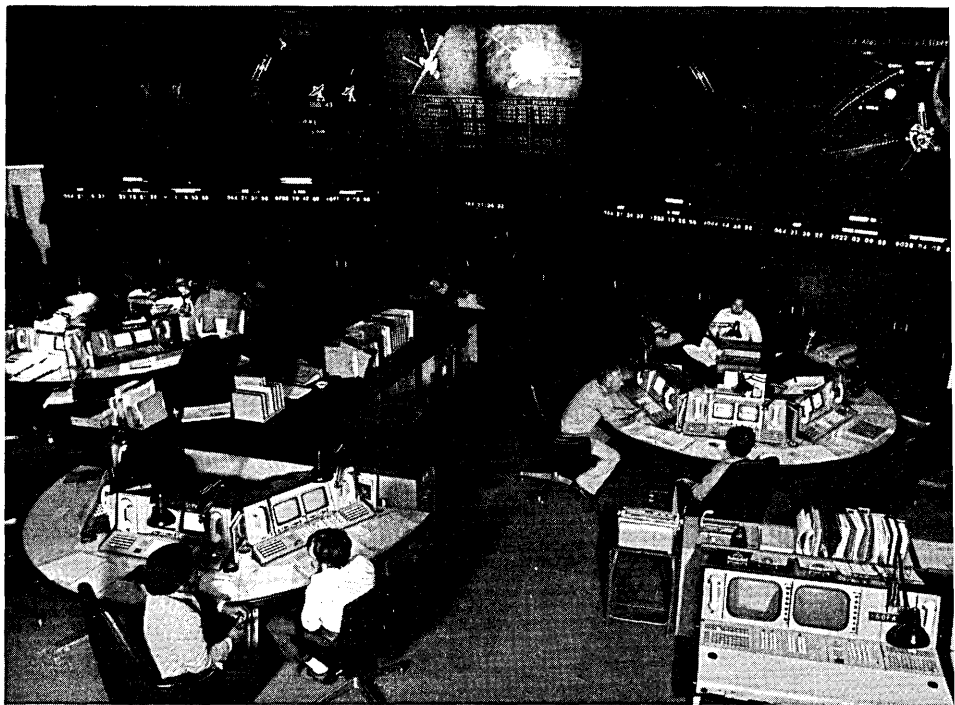

Space Exploration

Viking's Exploration of Mars: "Impossible Without Computers"

H. G. Wells, the English novelist, historian, and sociologist, had it all wrong in his science fiction classic *The War Of The Worlds*, for history was to show just 30 years after his death in 1946 that it would be the Earth "invading" Mars, and not the other way around. The "invader" is the highly successful project Viking Mars Mission, a \$1 billion cooperative effort of the U.S. National Aeronautics and Space Administration (NASA), the Martin Marietta Corp., and the Jet Propulsion Laboratory of the California Institute of Technology, (JPL).

Just as in Wells' novel, however, there's more than one ship doing the invading: the second Viking lander will be taking more pictures than a Japanese tourist of the Martian environment should all go well with its landing, now tentatively scheduled for Sept. 3.

Interestingly, Wells' death occurred in the same year considered by many to be the birthdate of the age of the computer—the device that more than any other makes trips to Mars and the resultant photos, weather reports, and biological analyses possible. "It is a fair statement to make that this mission would not have been possible without computers working together not only around the world, but in the vicinity of Mars, and on the Martian surface, too," says Phil Cuddihy, NASA's Lander System Engineer most familiar with the computers on board the spacecraft.

"Two principal considerations make the computers on board the orbiter and lander absolutely essential. First, the time delay for transmissions between the spacecraft and the earth are on the

order of 20 minutes, requiring the Viking to do many things (such as the entire landing sequence) on its own, and secondly, Mars rotates much like the Earth, meaning that the lander is out of view from the Earth for approximately 12 hours each day. This means that if we want to take full advantage of the experiment time we have on our rare visits to the planet, we need an overseer—the computer—to run the shop while we can't."

Honeywell number one on Mars

The overseer charged with "running the shop" is a Honeywell 24-bit cpu (plus one all important parity bit) with the model designation HDC-402P. Although the cpu is a modified design of a unit used on Minuteman model intercontin-

"It's a fair statement to make that this mission would not have been possible without computers working together . . ."

ental missiles, the HDC-402P, which acts as the Guidance Control and Sequencing Computer (GCSC) is a block redundant, random access, customized, though general purpose computer, and any Honeywell DDP-324 programmer would feel right at home with this machine's orientation.

There are 18,432 words of non-destructive-read-out (NDRO) memory made up of 16K of 2.2 mil plated wire dynamic memory, plus 2K of read-only memory; direct, indirect, and indexed addressing; six levels of priority interrupts; a programmable timer; real-time error

detection; and a repertoire of 47 instructions. The minimum instruction time is 4.34 usec for a jump, twice that (8.68) for an add, and 123 usec (!) for a divide operation. Six registers are used to communicate with other functional devices on the spacecraft.

The GCSC is actually two separate computers, each containing a memory, processor, I/O and power supply modules for redundancy. All the software required to accomplish the Viking mission is resident in the computer's memory (there is no auxiliary program storage device such as a disc unit like the kind we use on earth). To get the maximum use out of the memory complement, routines are stored in table form so that similar procedures can in effect "borrow" logic from a neighboring program instead of having to have its own particular set of commands. For example, the step-by-step sequence on how to adjust the craft's two cameras for a particular viewing angle is the same for each camera, with instructions "tagged" for use with either camera A or camera B.

Reliability and redundancy

Should something go wrong with the primary portion of the on-board computer, a number of options are available. The primary cpu continually puts out a pulse to the power system on the spacecraft essentially telling it that all is well. Should the primary cpu detect that the power level is falling, for example, the computer will halt and wait for the power to come back to an acceptable level. If something knocks out the primary side, or "string," of the com-

news in perspective

puter, the backup side can be powered on and instructed to carry on, though it might take two weeks for this unit to be updated on what the status of the mission was when its sibling failed.

The orbiter's computer is attached through an umbilical cord to the lander's computer during the nine-month trip to Mars, though the lander's computer is "awakened" just prior to the spacecraft's maneuver to orbit Mars. The orbiter's computer awakens the lander computer and instructs it to perform a four-hour checkout to ensure that it is in good health. Then, for the critical phase of the flight where a rocket motor is fired to place the Viking into orbit around the red planet, both cpu's simultaneously issue the "fire" command to ensure that it gets through. (The consequences of its not getting through jeopardize the entire mission, for the approaching spacecraft would almost certainly either collide with the planet or fly rapidly—and irretrievably—past it.) So far, the primary computer "string" aboard each separate spacecraft has performed perfectly, with not a single bit being dropped—or gained.

On board data storage

Information that is to be relayed back to earth is initially collected by the Data Acquisition & Processing Unit (DAPU), which has 8K (24-bit) of storage and a 4-track tape recorder reporting to it. The storage is a buffer to hold data for transfer to the tape recorder, but the two devices can back each other up should one fail. There shouldn't be a problem with broken tape up on Mars—metal is used as the recording medium, not Mylar. Under command from Earth tracking stations, information is dumped off the tape recorder and sent on the long trip home at selected periods each day when Mars is in a favorable position.

Despite the Jet Propulsion Laboratory's impressive arsenal of computers, it was determined early on the Project Viking (five years ago) that additional capacity would be needed to support simultaneously four relatively complex spacecraft (two orbiters and two landers). A third IBM 360/75 computer had to be acquired to serve as a backup unit for two others that are used to receive all Viking Lander telemetry data, all tracking data, and transmit all commands in real-time. In addition, these three machines also perform non-real-time processing of lander data, orbiter and lander command generation, and performance analysis.

There are three sets of Univac 1530/1219 pairs that are applied to col-

lecting and processing all real-time orbiter data, with one pair used as a backup. The 1530 is a dual cpu, single memory design with 64K 30-bit words of storage which cooperates with the 18-bit model 1219. These machine pairs, together with three Univac 1616s, are responsible for putting together the remarkably detailed photos of the Martian surface from telemetry data. Two Univac 1108s are used to perform many non-real-time data processing functions that include navigation calculations, orbiter spacecraft performance, and science data analysis from both the orbiters and the landers.

An additional responsibility of the 360/75s is program evaluation and validation for procedures that are to be transmitted to the spacecraft. A software simulation of all command sequences is performed by the 360, showing what the result of these commands will be on the spacecraft. If the proposed procedure is critical to the mission—such as freeing up the surface sampler arm that came to a mysterious halt early in the mis-

sion—command sequences can be run through either of two landers built for the purpose, one at the Martin-Marietta plant in Denver, Colorado, and the other at JPL in Southern California. In this manner it can be verified that command sequence alterations won't do something dumb like force the surface sampler to dig into the camera lens. All program sequences are checksummed, and the sum is transmitted along with the program up to Mars; if all of it doesn't arrive, neither the orbiter or the lander will attempt to execute it.

So, in addition to participating extensively in the design phases of Viking spacecraft, computers both on the earth as well as on or in the vicinity of Mars (which is on the other side of the Sun from the Earth currently) are highly involved with a successful mission that can be dynamically altered to suit both scientific and operational necessities. There is already talk of a craft that could do much of what Viking has done, and then rocket surface samples back to the earth for more extensive analysis—an even more challenging task for the on-board computers. What a shame Wells won't get to see it.

—Michael Cashman

Communications

Vendors, Users Lean to International Packet Switched Protocol at Meeting

A number of terminal and systems manufacturers are developing packet network interfaces based on a new international protocol, called X25, and plan to begin marketing them within the next year.

A number of key users also have decided to support the X25 scheme.

Meanwhile, AT&T is looking for a way to market an interstate version of its Transaction Network Services (TNS).

And Western Union International (WUI) is getting ready to announce a hybrid-circuit-and-packet-switched international data communications service.

These were some of the developments reported by sources attending last month's meeting of the International Council for Computer Communications (ICCC) in Toronto. The manufacturers said to be developing X25 interfaces include Digital Equipment Corp., Honeywell Information Systems, Comten, Memorex Corp. and Computer Transmission Co.

The state of California, which soon will begin transmitting packets over a network supplied largely by Pacific Telephone, is one of the users planning to support X25. Specifically, they'll ask the phone company to acquire switching and multiplexing equipment capable of implementing the new protocol, along

with older asynchronous and synchronous disciplines. Another user, the Univ. of Alberta, is developing an X25 interface, resident on a PDP-11 front end, between its recently-acquired Amdahl 470 V/6 computer and Datapac, the new public packet network built by the Trans Canada Telephone System (TCTS).

Western Union's new packet-and-circuit-switched hybrid service will be unveiled officially "within two months," according to a company source. The circuits will connect the U. S. with unspecified "Western European" countries and it will be possible for customers to interface with packet networks on both sides of the Atlantic. Initially, WUI plans to offer low-speed ("up to 300 bps") connections. Data base access will be the primary application. Data bases maintained by Lockheed and by the National Institutes of Health (NIH) were specifically mentioned. Later, according to the source, "we'll expand this new service into a general public offering."

State, not federal, tariffs

One source with unusually good contacts inside AT&T, said the company has been considering the use of dial-up circuits to support an interstate version of Transaction Network Service. The goal

The Morning Sickness Bug.

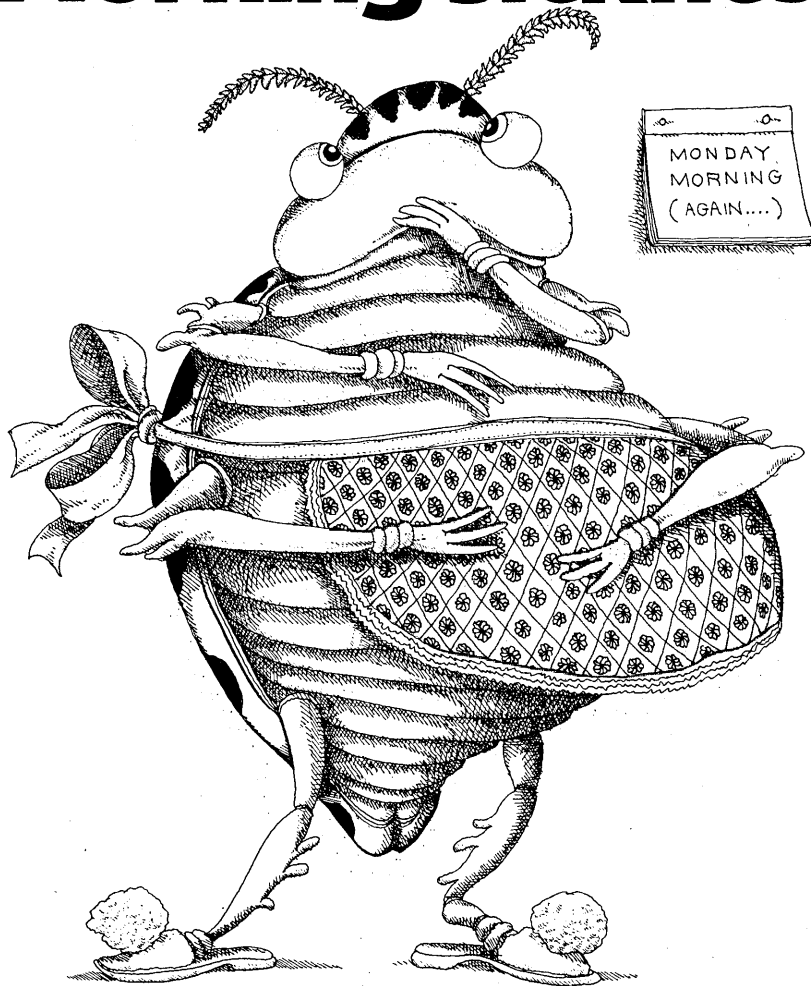

When your computer gets it, your pocketbook hurts, too.

The Morning Sickness Bug occurs when your air conditioning system is not maintaining a precise, controlled environment. And not thinking about your computer's environment can turn out to be a losing proposition for you.

EDPAC Process Cooling Systems are specially engineered to create an exact, totally regulated environment. And they are designed specifically for

your particular requirements. With full redundancy and alarms. So you can rely on them to protect your computer as no regular air conditioning system can.

Before the Morning Sickness Bug makes you feel worse than your computer, find out what a big difference an EDPAC Process Cooling System can make. And find out today!

FREE BOOKLET. HOW TO GET THE BUGS OUT.

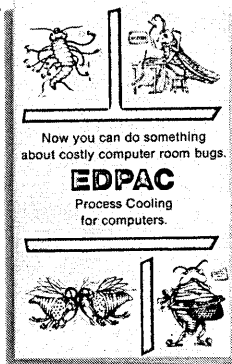

Please rush me your Free Booklet and the name of my nearest EDPAC Specialist.

Name _____

Title _____

Company _____

Address _____

Phone _____

EDPAC

PROCESS COOLING FOR COMPUTERS

D96

Mail to: EDPAC, AC Manufacturing Company, Cherry Hill, N.J. 08034

EDPAC is a product of AC Manufacturing Company

news in perspective

is to get the terminals tariffed by the states rather than the feds, and thereby minimize objections from the FCC and suppliers of competing, non-regulated "communications processing" service. This source also reported that Northwestern Bell recently submitted a proposed TNS tariff to the Minnesota public utilities commission. If approved, it will be the second such offering by an AT&T affiliate. The first was unveiled a few months ago by Pacific Northwest Bell in Washington State (August, p. 105).

Interface for 3705

IBM's plans for supporting X25 remain shrouded in mist but at the conference TCTS demonstrated an interface for the 3705 which, essentially, will enable this communications processor to packetize messages sent to the Datapac network from 360s or 370s and de-packetize messages received from the network. TCTS officials said a Datapac tariff will be filed next October or November, and commercial service will begin soon afterward.

Reportedly, 12K bytes of memory inside the 3705 are needed to store the X25 conversion software. The program currently resides within a 3705 at Bell Northern Research in Ottawa. It's con-

nected to a 370/168. Bell Northern users reportedly have been exercising the new interface for "several months."

Since X25 supports only intelligent terminals, it has only a limited market. But TCTS has developed an "interactive terminal interface" (ITI) that permits connection of non-intelligent terminals to the Datapac net—specifically, low-to-medium-speed asynchronous, ASCII-based terminals like Model 33 and 35 Teletypewriters. Similar interfaces have been developed by Telenet, the U. S. packet carrier, and by the French Telephone Administration, which has an experimental packet system (RCP) operating and plans to offer a commercial packet service (Transpac) throughout France in 1978.

TCTS also has developed a packet network interface for the Amcat I and NCR 280 terminals. It's working on similar interfaces for interactive, multi-leaving batch, and non-ASCII asynchronous terminals—like the 3270, 2770, and 2741, respectively—as well as interfaces for "banking and point-of-sale" terminals. At least some of this software is likely to become commercially available within the next year.

Telenet, which already offers an interface for non-ASCII asynchronous ter-

minals, is "looking at" one for multi-leaving batch equipment, as well as other kinds, such as banking and point-of-sale terminals, said systems engineering director Barry Wessler. "But we're waiting to see what happens with AT&T's Transaction Network Service, before deciding to offer the Banking/pos interface." He indicated that the phone company's new offering may limit opportunities for independent suppliers.

Hardware manufacturers

Some hardware manufacturers reportedly working on X25 interfaces:

—Computer Transmission Co. already has printed a brochure advertising the addition of X25 packetizing/de-packetizing capability to its M3200 Packet system, which includes time-division multiplexors, data switches, network control centers, and "special-purpose modules for network protocol-dependent processing." President Ray Sanders indicated the new interface will be commercially available within a year.

—Comten: President Don Herman said that "within a year," his company will offer an X25 implementation on its Model 3650, 3670, and 476 equipment. All three units basically are front-end processors but also may serve as remote concentrators or stand-alone message switches.

—DEC has "no plans" at the moment

When You Lease It from RCA The GE TermiNet* 30 Printer Gives You Speed . . . Flexibility . . . Economy!

The GE TermiNet 30 mag tape ASR matrix printer is designed to give you three major benefits — you save time, money and trouble. And it's simply more economical when you lease the TermiNet 30 printer from RCA. We offer a nationwide service network to back you, too. The RCA lease price includes maintenance by data communications specialists based in over 140 cities. Seven warehouse locations coast to coast ensure fast delivery and prompt installation.

The TermiNet Printer offers many features:

- Prints at 10, 20 or 30 cps
- Transmits at speeds up to 1200 Baud
- Single cassette magnetic tape; stores 100,000 characters
- Versatile editing capability
- Answerback (supplies 20 characters)
- Vertical tabulation and form out
- Adjustable pin-feed platen 4" — 9½"
- Data-Phone+ (Dial-Up) capabilities (hardwired or telephone acoustical coupler)
- Permits terminal use with data access arrangement (DAA), Type 1001B CBT
- Ribbon cartridge — a snap to install.
- 300-Baud originate — only automatic answerback integral modem
- Options available include dual magnetic tape cassette, 132 character line-16.5 char./inch
- 8-level ASCII code

For full details and rates call or write:

RCA Service Company, A Division of RCA
Technical Services Bldg. 204-2, Cherry Hill Offices
Camden, N.J. 08101. Phone: (609) 779-4129

RCA

*Registered trademark of General Electric Company • Registered servicemark of AT&T.

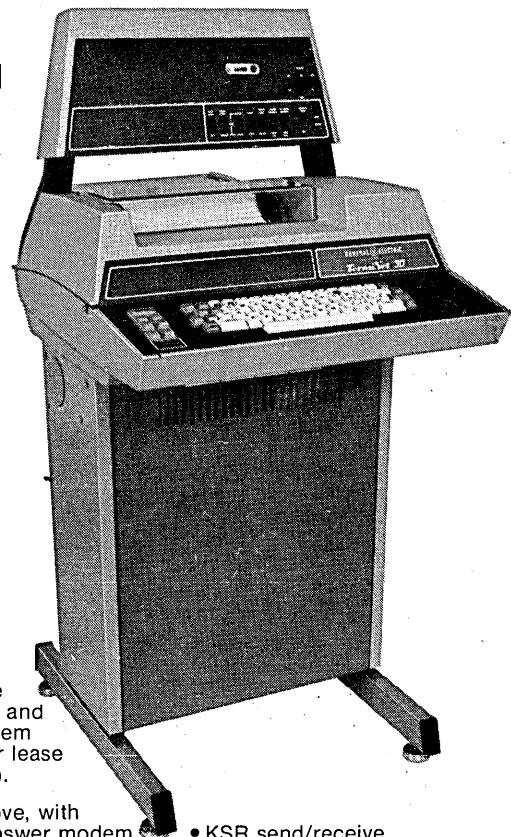

- ASR with mag tape
With single cassette and originate-only modem
\$135/mo. on 1-year lease
(incl. maintenance).

- Same as above, with automatic answer modem
\$145/mo. on 1-year lease
(incl. maintenance).

- KSR send/receive
\$90/mo. on 1-year lease
(incl. maintenance).

to implement X25, according to Stuart Wecker, a member of the company's network development group. "However, we see no problem in adding X25 to our existing Decnet interface."

One possible result of these developments is that within the next few years, a family of universal interfaces will be developed enabling users of many different makes and models of computers and intelligent and dumb terminals to interface with all of the world's packet networks. This, of course, is the promised land which promoters of X25 have been advertising for a long time. But it is equally possible that the promised land may turn out to be a mirage.

CNCP, Canada's "other" major carrier, is developing a hybrid packet/circuit-switched network, called Info-Switch, which will use many, but not all features of the X25 protocol that was adopted last spring as a draft "recommendation" by study group VII of CCITT, the international association of telecommunication carriers. Notably, CNCP is planning to use a different call setup procedure.

IBM also different

There are said to be similar differences between X25 and at least some of the proprietary protocols developed by various manufacturers. IBM's SNA/SDLC scheme is the one most frequently mentioned.

These differences may be ironed out after CCITT gives its final blessing to X25. That event is likely to occur this month. But competitive rivalries suggest that each carrier and supplier will continue to support a version of the X25 "standard" which is just different enough to make it expensive for a customer to transfer his allegiance.

Louis Pouzin, who is probably the most vocal critic of X25, alluded to this problem in a paper he gave at ICC. "In practice, some carriers apply CCITT standards at home with a number of so-called 'national options' . . . Hence, CCITT standards . . . are not as standard as one might think they are." X25 also impinges on the data processing industry's traditional turf, and this leads to additional incompatibilities, he contended: "What the . . . carriers tend to overlook is that computer specialists are old hands at masking out interfaces they don't like . . ." The result is an interface that's more complex, and expensive, than it has to be, he added. "The customer (or the taxpayer) has to foot the bill, but who cares as long as he has no other choice?"

Wants datagram service

Pouzin is director of an ARPA-type packet switched network called Cyclades, which interconnects a number of

French scientific centers. For a long time, he has been nagging the carriers to offer "datagram" service in addition to the "virtual call" service specified in X25.

Under the datagram scheme, a carrier-specified protocol controls message flow within the network, and the user—or his supplier—specifies the codes that regulate communication between the end points of the message path. The bits comprising the user's message, as

AT&T considers using dial-up circuits to support an interstate version of Transaction Network Service.

well as those controlling the end-to-end control codes, are placed inside the carrier-specified protocol and travel through the network without being altered.

One way of implementing such a scheme would be to locate the user-network interface in a remote terminal controller and a computer front end, use HDLC to communicate between these two points, and embed the user-specified protocol as well as his message, in the HDLC information field. This can't be done without rewriting the

The key difference in computing services is people.

Think for a moment. When you have problems with computer services, are they rooted in hardware, software or people? Generally, it's people.

At CallData™ we're concentrating on people to provide personalized service. But, of course, our house is in order.

We have: *five* major computer systems; *five* major software libraries plus selected application software; coast-to-coast networks in operation; complete technical support; and backup in other areas, such as microfilm services and automated publications.

So try your problems on CallData. We have a full house with a real difference: people who believe that personalized service is the way to grow.

For help please call your local CallData office or Kurt Thoss, CallData Systems, Inc., 20 Crossways Park N., Woodbury, N.Y. 11797. (516) 575-3298. Subsidiary of Grumman Data Systems Corporation.

We have *five* systems to personalize computing.

•TS•RJE/Timesharing

—370/155M2 VM/CMS

•TS•RJE?Batch

—370/168 OS/VS

•DTSS Dartmouth Timesharing 1g

—Dual Honeywell 635

•Comp/Utility Timesharing

—Triple DEC System 10

•Telescope™/Remote Computing

—CDC Cyber/73

- Many applications
- Complete technical support
- Systems analysis and design
- Programming
- COM and microfilm services
- Education
- Automated publications
- Competitive rates

CallData™

Personalized service is our way to grow.

• New York • Chicago • Boston • Philadelphia • Washington • Hamden, Conn. • Long Island

news in perspective

present version of X25, however, because it specifies a "packet-level" protocol, controlling end-end communication, that uses several bytes within the HDLC information field.

Pouzin insists the carriers want to specify the end-end control codes mainly so they can control the kind of terminal and communications subsystems attached to the ends of the packet message path. In at least some cases, he adds, the carriers want to supply this equipment themselves.

Carrier spokesmen have denied these charges repeatedly, but at last month's ICC, there was some evidence that Pouzin may be right.

P. T. F. Kelly, director of planning for the British Post Office and one of the chief architects of X25, in the course of discussing papers presented by Pouzin and others at a session on "National Policies and Business Development in Computer Communications," said there is no basic difference between traditional circuit multiplexing and the multiplexing of messages generated by individual "user processes" within an intelligent terminal or computer.

Traditionally, this latter function has been performed largely by dp systems.

—Phil Hirsch

Training

S/3 Programmers Anyone?

What may be the first training school for IBM System/3 programmers graduated its first class last month but it's hardly flooding the world with System/3 programmers.

The Los Angeles Urban League Training Center started its System/3 program last February and installed a System/3 Model 10. The center is supported by IBM and it was the computer giant's idea to start the course.

"IBM looked at the market," said Irma Hopkins, an IBM systems engineer on temporary loan to the center to teach the first three S/3 courses. "In the Los Angeles area," she said, "there are more than 5,000 S/3 installations."

So the systems are there and the course is available. The Urban League Training Center is in its seventh year of training disadvantaged students for careers in data processing. The S/3 course replaced a discontinued keypunch course. It lasts for 12 weeks on 9 to 5 schedule five days a week, "but most

students stay late," Hopkins said.

She said 13 is the maximum for one class but she hasn't hit that yet. The first class graduated six students and the second class five. "We'd like more."

Placement hasn't been easy either. "We're up against unemployed programmers used to big systems who can easily handle a System/3 and need jobs." She particularly cited former employees of Xerox Data Systems. The center has placed four of the six graduates from its first System/3 course.

Hopkins said the students that elect to take the S/3 course over a 370 COBOL programming course that the center also offers, choose it because it offers "a whole concept. We teach RPG II programming, accounting principles, disc design, disc concepts, and all technical aspects of the system. When our students are finished they are real professionals."

Hopkins will be teaching one more S/3 12-week course beginning Sept. 27. Then it's back to being a systems engineer. *

Companies

What's In a Name?

What would you expect to buy from a company called The David Jamison Carlyle Corp.?

Securities maybe or a family plot. Certainly not Teletype compatible computer terminals but that's what the firm sells.

The David Jamison Carlyle Corp. was founded by Dennis Cagan, 31, former western Regional Manager for Lear Siegler's terminal operation. He lays claim to having sold more than \$25 million worth of video terminals over the past five years for Lear Siegler, Delta Data and Dataserv.

When he and his girl friend picked

MEDICAL COMPUTERS SYSTEMS

The automated health care industry is one of the fastest growing in the U.S. TELEMED Corporation is the world's largest processor of electrocardiograms (ECGs) by computer. We are a profitable, fast growing public company.

OPERATING SYSTEMS: You would work on one of the most sophisticated DEC system 10 sites in the Midwest. We have plans to upgrade our existing 2 K110s to 2 K110s with 256K core within one year. We need experienced people to develop assembly language application programs under TOPS10, do performance analysis, modify 6.02 TOPS10, and design and implement software for front end minicomputers in a real time, fault tolerant environment.

SYSTEM INTEGRATION: We need a real heavyweight in computers to integrate turnkey systems. An individual who can coordinate all the software and hardware resulting in a complete system to be delivered on time to a customer. A very important corporate job.

TURNKEY ENHANCEMENTS: As we integrate new customer systems we need an experienced individual to make enhancements to tailor systems to specific customers. Because of the amount of software involved (nearly 100,000 lines of Fortran and assembly coding) this is definitely not a job for a beginner. Many of the programs are extremely complex.

PROGRAM LIBRARIAN: This individual would check out new versions of utility programs, coordinate releases of in-house software systems and be responsible for test results. This is an entry level position which could lead to other more technically demanding work.

TELEMED provides a stimulating and challenging environment for highly qualified individuals. We have two Xerox Sigma 5 computers, two DEC K110 computers and 5 minicomputers of various manufacture. We provide resources to maximize your efficiency and technical achievements through your own CRT for timesharing or hands on minicomputer machine time. Our rapid growth creates advancement possibilities for the future. Please indicate areas of interest in reply. Send to SOFTWARE AND PROFESSIONAL RECRUITMENT:

2345 Pembroke Avenue
Hoffman Estates, IL 60195

TELEMED CORPORATION

An Equal Opportunity Employer M/F

Perform a death-defying act.

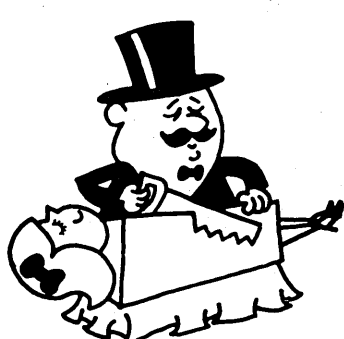

Reduce if overweight.

Give Heart Fund
American Heart Association

See things your way

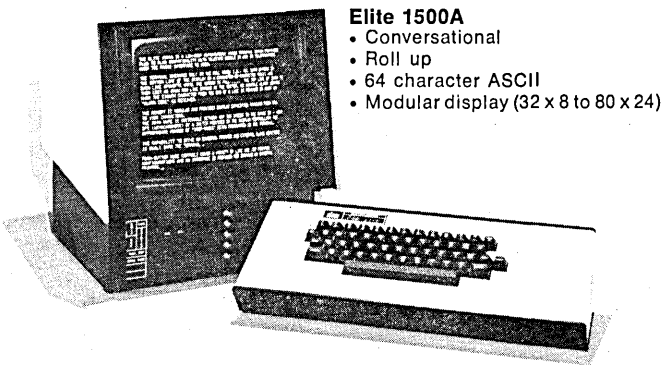

- Elite 1500A**
- Conversational
 - Roll up
 - 64 character ASCII
 - Modular display (32 x 8 to 80 x 24)

CIRCLE 106 ON READER CARD



- Elite 1520A**
- Conversational
 - X-Y addressable cursor
 - 64/128 character ASCII
 - Display 80 x 24

CIRCLE 107 ON READER CARD

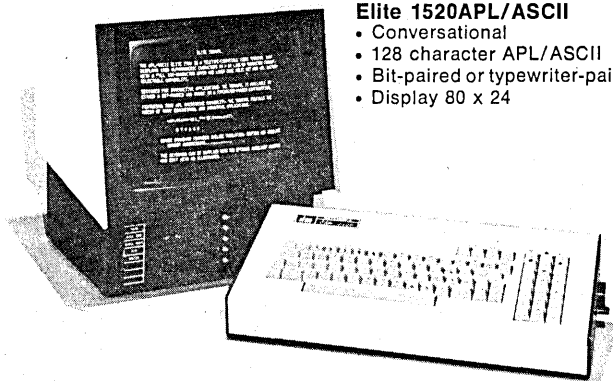

- Elite 1520APL/ASCII**
- Conversational
 - 128 character APL/ASCII
 - Bit-paired or typewriter-paired
 - Display 80 x 24

CIRCLE 108 ON READER CARD

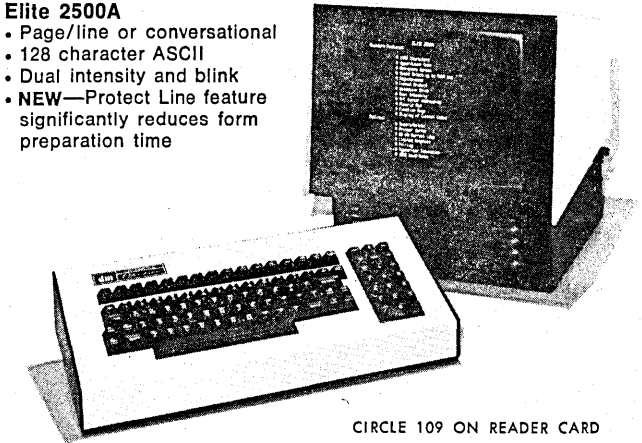

- Elite 2500A**
- Page/line or conversational
 - 128 character ASCII
 - Dual intensity and blink
 - **NEW**—Protect Line feature significantly reduces form preparation time

CIRCLE 109 ON READER CARD

with Datamedia Elite Video Terminals

A family of video terminals that offers a wide range of features to perform an even wider range of data entry and display tasks.

If you're with an OEM firm or a system house, and look at peripherals with one eye on cost and the other on performance, you'll want to take a long look at these proven products from Datamedia.

Their modular design makes troubleshooting a breeze, and facilitates conformance to your system needs, and their quality workmanship assures that those needs will be met longer than you thought possible.

And if you believe in service after the sale the way Datamedia does, you'll appreciate the new dimension we've given to the word "responsive."

Datamedia. We've been seeing things the right way for users in industry, business services, government, education, medicine and research around the world.

Why don't you see what we can do for you.



Elite Video Terminals available in compact, portable versions.

CIRCLE 84 ON READER CARD

Datamedia Corporation

7300 N. Crescent Boulevard • Pennsauken, NJ 08110 • TEL: 609-665-2382 • TWX: 710-892-1693

18311 Lost Knife Circle • Gaithersburg, MD 20760 • 301-948-1670

Scientific Devices—Midwest • 2717 Wilmington Pike • Dayton, OH 45419 • 513-298-9904

5456 McConnell Avenue • Suite 150 • Los Angeles, CA 90066 • 213-397-3556

Canada: Datamex, Ltd., Ontario/Quebec • Belgium: Inex, (02) 512 4037 • Finland: Suma, (90) 440391 • Holland: Infodes Holland B.V., 055-230700 • Italy: Eltron s.r.l., (030) 55-26-41554 • Sweden: Teleinstruments ab, 08-38 03 70 • Switzerland: Teledynamics, 01-56 3300 • United Kingdom: Mellor Data, 020629-8181 • West Germany: Video Data Systems GmbH, (0 61 81) 7 39 51 • Australia: Intelec Data Systems, 232-3118 • Japan: Protech, Inc., (03) 384-0225.

news in perspective

the name for his new company, he wasn't sure what the company would be doing. It was started for tax purposes. "We started playing around with snooty names in various combinations." The only restriction was he wanted the name to match his initials—D.J.C.

Cagan really got his business going in June during the National Computer Conference when he committed to buy \$1 million worth of the new Beehive B-100 video terminals. He's already sold 5. "I get quantity prices so I can undersell Beehive and offer faster delivery since I'm already on their delivery schedule and they're heavily backlogged."

Cagan isn't going to handle only Beehive terminals. He's already looking at developing pollable terminals for small systems (the Beehive terminals are point to point) because he thinks "that's the way the small business market is going to go."

Aiming at medium size OEMs

In the early stages with his company he's aiming primarily at medium sized oem's. He's offering quantity price discounts but selling one at a time. "Manufacturers can't do that and the medium

oem's don't like paying for quantities when they want to get them one at a time."

He doesn't feel this will be his business in the future though. He thinks the terminal market ultimately will be a consumer market much as the calculator market is now. He thinks it will include such things as crt terminals in the form of wrist watches. It's a market he intends to be in.

Cagan, who majored in economics at UCLA, didn't set out in life to sell terminals. After a stint in the marines he ran a lamp factory but he didn't think he was going to get anywhere with that.

He took several months off during which "I just lay around the pool at my apartment thinking about different industries I might want to get into." He decided computers were it so, through a friend in his apartment building, he got a job as a computer operator with Service Bureau Corp. which he held for a year. From there he got into time-sharing sales with the Pillsbury subsidiary, Call-a-Computer. Then a small systems firm which was acquired by a sales representative firm and merged into a company which became Dataserv. And that's when he began selling terminals. *

Credit Reporting

Data on Businesses Now Offered by TRW

The huge personal credit reporting group at TRW, Inc. last month began offering a similar service on some 600,000 business firms. It also was converting the operating system of its IBM 370 machines in Anaheim, Calif., to take advantage of cheaper storage to hold a rising flood of data.

The new service, called National Credit Information Service, is being marketed by the National Association of Credit Management (NACM) to its 39,500 members who include credit managers of most of the large industrial and financial concerns in the U. S. Members with teleprinters will get credit information directly from TRW's computers and those without terminals will buy the information from 50 local NACM offices who have teleprinters.

Information is extracted from the automated accounts receivable data provided on tape, and sometimes disc, by contributing firms every 90 days. About 520 companies now are providing information and TRW officials expected eventually to be receiving data from some 2,500 contributing customers on about 2.5 million companies.

The service will be run on the same

This coupon will change your thinking about inking.

Name _____
Firm _____
Address _____
City _____ State _____ Zip _____
Phone _____

And cut the cost and hassle of your imprinting.

Consider Dayco's line of porous imprinting rollers. Ink-impregnated rollers designed for precision ink transfer, even at high speeds. *Custom* designed to fit your present system or one of many new Dayco inking sub-assemblies.

Hand stamping, credit card records, print outs, dozens of types of imprinting can cost you less. Hassle you less. And

just plain look better, when you use Dayco porous rollers.

Phone 513/226-5866, or mail your name and address to Mr. R. Waddell, Dayco Corporation, Printing Products Division, P.O. Box 1004, Dayton, Ohio 45401. We'll send you the full story on the finest and most complete line of inking rollers made.

DAYCO
CORPORATION



DAYFLEX COMPANY

PRINTING PRODUCTS DIVISION DAYTON, OHIO 45401

CIRCLE 125 ON READER CARD

computers as TRW uses to keep credit tabs on some 50 million persons applying for loans and charge accounts in 19 metropolitan areas—two 370/158s and a 155. TRW is now converting from OS/MVT to IBM's top-of-the-line operating system MVS, release 3.7 so that it can acquire IBM's new 3350 disc drives. At present, some 16 billion bytes of data are stored on 80 spindles of IBM's 3330 disc drives.

For the 3350s

Tad Davies, director of computer technology, said the company is selecting MVS solely to take advantage of the new devices which IBM supports only on vs machines. The same amount of data can be stored on about 60 spindles. But the main saving is in storage costs, which are reduced to \$2.80 per million bytes on a 3350 from \$5.60 per million bytes on a 3330. "That's \$45,000 a month—enough to buy another cpu," says Davies who thinks TRW probably will add a third 158 and later turn to a configuration of a 158 and 168. "We've never stayed more than 18 months with the same computer system," says Davies of the 10-year-old operation.

TRW began the conversion in the first quarter of this year and is moving in "small steps" to complete conversion. One of the 158s began running MVS in June and the conversion should be completed sometime in the fall.

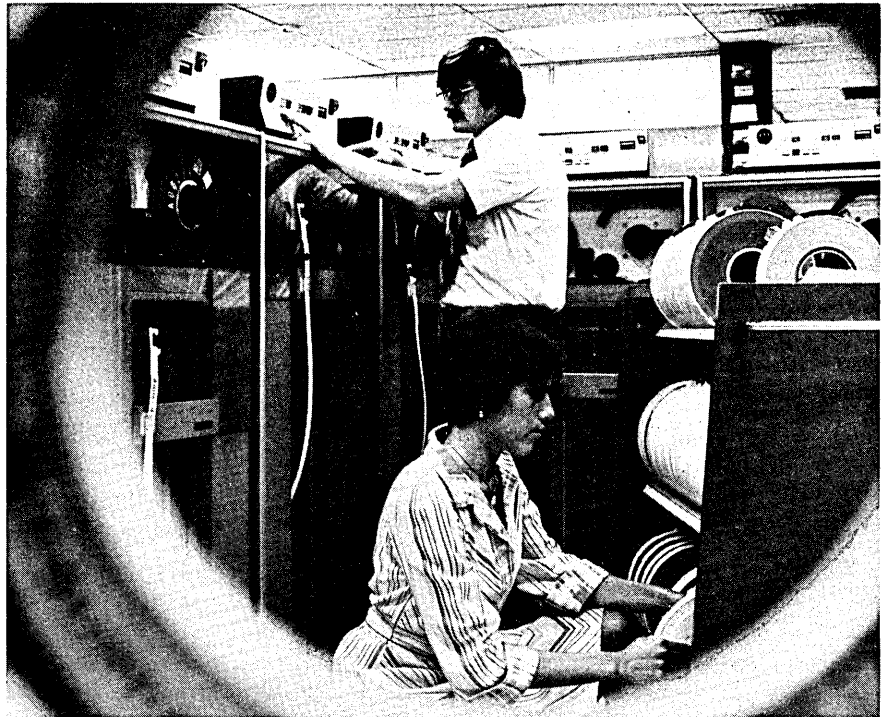

MANAGING TAPES: The growing files at TRW require a close analysis of tape and disc usage. Company is converting to IBM's MVS operating system to conserve disc storage. Next move: an IBM 3850 mass storage device?

The National Credit Information Service has been in the works five years. It began as a study by NACM and TRW and an organization called the Credit Research Foundation. The study, ac-

ording to recent statistics, was timely. Federal Reserve Bank estimates say total corporate accounts receivable in the U. S. grew to almost \$300 billion by late last year, up 40% from 1970.

BEEMAK TABCARD HOLDERS

Since 1951 — BEEMAK — supplying holders for all types of D.P. systems

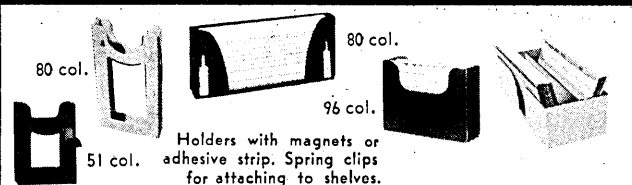

Holders with magnets or adhesive strip. Spring clips for attaching to shelves.

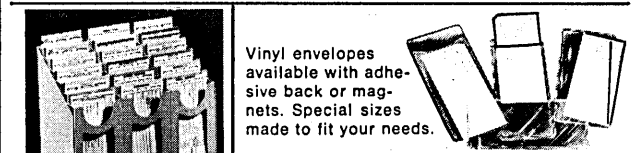

Vinyl envelopes available with adhesive back or magnets. Special sizes made to fit your needs.

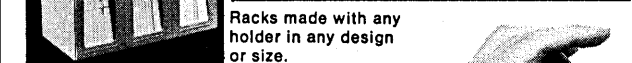

Racks made with any holder in any design or size.

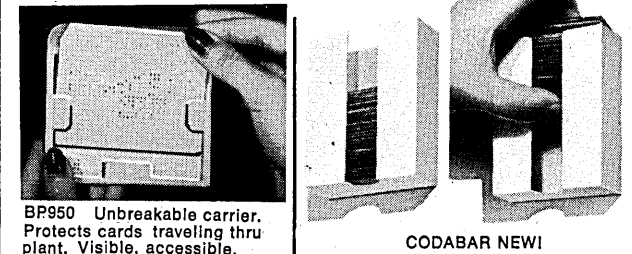

BP950 Unbreakable carrier. Protects cards traveling thru plant. Visible, accessible.

CODABAR NEWI

BEEMAK PLASTICS

7424 Santa Monica Blvd., Los Angeles, Calif. 90046
Phone: (213) 876-1770

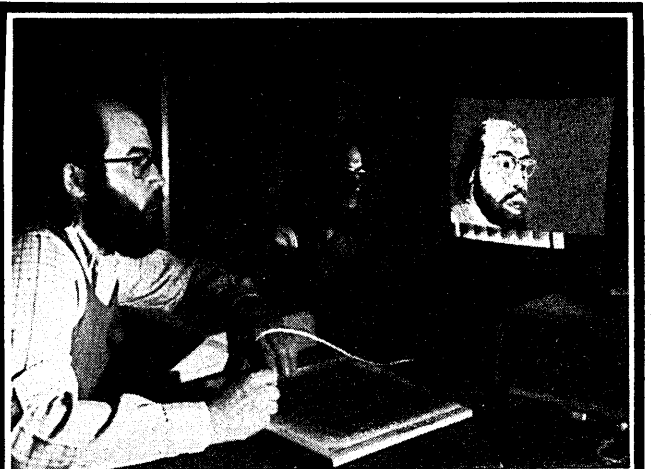

ARTIST AND COMPUTER is a unique new art book that covers a multitude of computer uses and the very latest techniques. In its pages, 35 artists who work with computers explain how the computer can be programmed either to actualize the artist's concept (such as the visualization of fabric before it is woven) or to produce finished pieces. Illustrated with more than 160 examples of computer art, 9 of them in full color, **ARTIST AND COMPUTER** will fascinate and inspire anyone who is interested in art or computer technology. Size 8½" x 11"

Edited by **RUTH LEAVITT** H·A·R·M·O·N·Y
B·O·O·K·S

Paper \$4.95 cloth \$10 now at your bookstore, or send check to Crown Publishers, One Park Ave., N.Y., N.Y. 10016, N.Y. and N.J. residents, add sales tax.

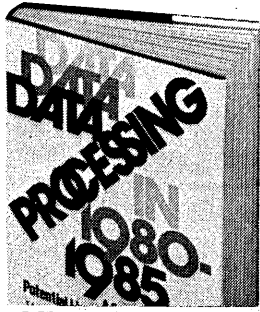

Identifies tomorrow's problems today

DATA PROCESSING IN 1980-1985

A Study of Potential Limitations to Progress

T. A. Dolotta, et. al.

As the title indicates, this SHARE Inc. study forecasts the problems the data processing industry will face in the near future. It examines in detail the changing requirements that will be forced on the industry as the percentage of the labor force depending upon data processing grows from 30% today to 70% in 1985.

(0 471 21783-2) cloth 1976 191 pp. \$13.50
(0 471 21786-7) paper \$ 6.95

ALGORITHMS IN SNOBOL4

James F. Gimpel

A collection of programs written in SNOBOL4 language, this book covers compiling, game playing, text formatting, story, poem, and brand-name generation, Monte Carlo techniques, sorting, and more. A top-down approach stresses proper style and structure, with algorithms oriented to nonnumerical programming.

(0 471 30213-9) 1976 487 pp. \$19.95

QUEUEING SYSTEMS

Volume II: Computer Application

Leonard Kleinrock

Kleinrock explores bounds, inequalities, and approximations, capturing the essential behavior patterns of queueing systems including *transient* and *non-stationary behavior*. The book also establishes a basis for time-sharing studies by developing the fundamental notions of priority queueing systems using single- and multiple-resource models.

(0 471 49111-X) 1976 549 pp. \$24.95

ABEND DEBUGGING FOR COBOL PROGRAMMERS

B. H. Boar

Since few programs are developed without the occurrence of Abends (Abnormal Endings), Boar uses the ANSI COBOL language under 360/370 OS/MVT operating system as a case study to provide a systematic approach to types of Abends most familiar to the COBOL/OS user. The book contains a wealth of information useful for interpreting, analyzing, and debugging Abends.

(0 471 08413-1) 1976 321 pp. \$17.50

Available at your bookstore or write to Peter Hodges, Dept. A 2056-57.



WILEY-INTERSCIENCE

a division of John Wiley & Sons, Inc.
605 Third Avenue, New York, N.Y. 10016

In Canada:
22 Worcester Road, Rexdale, Ontario

Prices subject to change without notice.
092 A 2056-57

CIRCLE 149 ON READER CARD

news in perspective

TRW thinks the market for business credit information will grow to \$590 million by 1983, more than double the estimated 1975 volume of about \$251 million.

A TRW credit report contains information on how firms pay their bills to other suppliers, based on automated information from these suppliers. A typical report lists the date of last sale, payment terms, recent maximum credit, amounts currently owing and past due amounts in 30, 60 and 90-day categories. With the report is a trend analysis of a firm's payment record for the previous six months. Its types of creditors are not identified but lumped instead into industry groupings.

A member who contributes information to TRW pays \$3.55 or \$3.95 for a report, depending on whether he has a teleprinter or gets the information from the local NACM office. Others are sold at from \$5 to \$6 through the NACM, which shares revenues with TRW for its marketing services.

The biggest provider of business credit information is Dun & Bradstreet who services 80,000 client concerns and has information on more than three million companies. It sells its services under individual contracts that obligate a company to buy a specified number of reports a year. (TRW customers, on the other hand, pay a flat fee for each report.) In some cases, the D&B contract can run large companies into the hundreds of thousands of dollars a year and smaller concerns find it difficult to use as many reports as called for under the contract.

So as the TRW files fill up, many D&B defections can be expected, according to some credit managers. Spokesmen for D&B and TRW, however, say that clients may take both services, since they don't fully duplicate each other.

Nevertheless, TRW executive vice president J. Sidney Webb says, "It'll irritate them." He said TRW was approached by the credit managers association because of its track record with the personal credit reporting system. "We had the software in place and the experience," says Webb. However, the business reporting system required an additional software development program that cost TRW close to \$1 million.

Says Davies, whose job is to deal with the problem of storing the huge mass of data, "we've got to seriously analyze our file storage. Some things don't have to be on disc." The next step might be IBM's 3850 mass storage system, "but not until we're convinced that IBM has solved its software problems with the 3850," Davies says.

—T. M.

Financial

A New Financial World Out There

The First National Bank of Boston employs a bright and articulate economist who dashes about the pages and television sets of Boston newspapers and television stations, singing the praises of business expansion. He enjoys high media visibility and is a vocal promoter of business and industrial growth.

But, like all banks, the First National Bank of Boston has a clandestine side, which at times may appear to be counter-productive.

A glimpse into that darker side occurred recently when the bank, the lead bank among those lending to Cambridge Memories Inc. of Bedford, Mass., decided to call the loans they had with the computer firm.

What has sent shivers through other smaller computer companies is the fear that the Boston bank's action may be a new sign of troubled financial times for the computer industry, new times in

Boston bank's action may be a sign of troubled financial times for the computer industry.

which banks may be feared rather than trusted.

A few weeks before the banks decided to call the loans, Cambridge Memories (CMI) made an announcement that John J. Coleman had joined the company as chairman of the company's operating committee. Knowledgeable sources said that Coleman had been appointed at the insistence of the bank and the sources believe that Coleman represented the interests of the bank rather than those of Cambridge Memories.

Not Insurmountable

The most intriguing aspect of the situation was that many believe CMI's problems were not insurmountable. The firm had a good lease base valued at \$13 million (which it pledged to help meet its indebtedness of \$16 million). Moreover, it had signed a promising deal with Control Data Corp. in which the smaller add-on memory firm was to manufacture an IBM-compatible mainframe it had designed for Control Data to market.

In addition, CMI had its on-going add-on memories business and it was rapidly developing and refining a semiconductor capability. The firm, however, was strapped for capital and critics of Cambridge Memories felt that the

They made The Intelligent Choice.

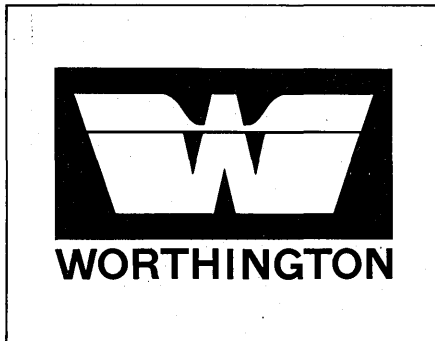
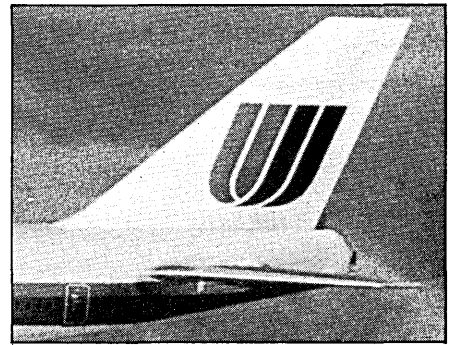
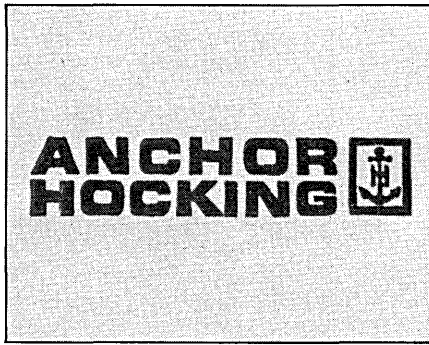
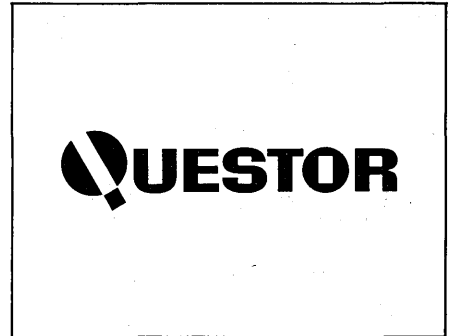
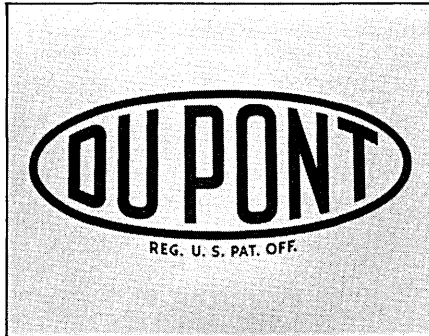

They chose Mohawk Data Sciences. For the very best reasons.

We began the revolution in data entry in 1964 with the introduction of our key-to-tape data recorder. Since that time, Mohawk Data Sciences has played a major role in the worldwide development of data entry and data communication equipment. The world's leading corporations, covering the full spectrum of business endeavors, have selected MDS to meet their most exacting requirements. Over 3500 companies (including a majority of the Fortune 500) chose Mohawk.

Our commitment to quality and innovation makes us invaluable to these extraordinarily successful companies. In pursuing this commitment, we manufacture a complete line of systems in our own facilities and to the highest, most rigid standards, possible.

As computer technology has traveled across the world, so has MDS. Our products are marketed and serviced through approximately 300 of our own offices in the United States, Canada, Western Europe, South Africa, and through independent distributors in more than 50 other countries. This far-reaching network permits us to serve multi-national companies with the international expertise that's absolutely essential. That's why we're the intelligent choice of the Fortune 500!

We'd like to tell you why all the companies pictured here—and many more too numerous to name—prefer MDS. We think their reasons will prove right for you, too. Contact your local MDS representative, or call or write us directly—so you can make your own intelligent choice.

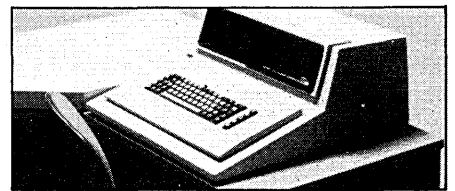

Mohawk MDS Data Sciences The Intelligent Choice.

MDS System 2400—System 2400, ideally suited for medium to large volume Data Entry installations, accommodates up to 32 key-stations, ready-to-use data entry software, user programmability, intermediate disk storage of up to 150,000 125-character records, concurrent communications, and more. Enjoy the same high level of performance that thousands of System 2400 users are experiencing worldwide by selecting System 2400 for your application.

EXECUTIVE HEADQUARTERS
1599 Littleton Road
Parsippany, N.J. 07054
(201) 540-9080

MDS CANADA, LTD.
85 Idema Road
Markham, Ontario
(416) 495-6060

MDS INTERNATIONAL SERVICE CORP.
Rue Ducale 53
1000 Brussels, Belgium
(02) 513-45-43

CIRCLE 27 ON READER CARD

FELIX FC 16/64 ELECTRONIC BILLING ACCOUNTING MACHINE

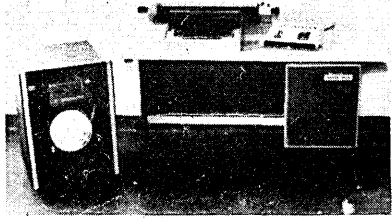

of advanced logical design implemented by microminiature technology. It employs integrated circuits which greatly reduce the need for discrete components, providing advanced equipment reliability:

- Data—16/64 registers of 15 digits each + sign.
- Work—3 stack registers + 1 supplementary register of 15 digits each + sign
- International decimal keyboard with several function keys as well as 3 manual selector keys.
- One digit display for program hexadecimal number.

FELIX FC 64 type optionally can be provided with a tape reader for program and data for processing, printing and punching.



Specialized Foreign
Trade Company
BUCHAREST—ROMANIA

2, Gabriel Peri st.

POB 105 tel. 151609

telex: 11406; 11547; 11584

CIRCLE 274 ON READER CARD

news in perspective

company had spread itself too thinly in too many different directions in a time when the Wall Street equity markets had dried up.

At this writing, Cambridge Memories was in business on a sharply reduced scale.

As nearly always seems the case in the computer industry there was another factor in CMI's problems—IBM. The colossus announced its 138 and 148 models at sharply reduced prices shortly before the banks called CMI's loans and this led some observers to speculate that the drastic price reductions of the new IBM equipment caused a minor panic in the banks.

Whatever the reasons for the problem, the whole situation serves to underscore the fact that there has been a new financial world out there in the past few years facing computer companies and it has as much comfort and predictability as a tornado.

The strong get stronger

The exception, already noted, is IBM. The dominant computer company continues to operate from a financial position of power that, if anything, seems to strengthen while the position of the remainder of the industry weakens. IBM, for instance, had \$4.7 billion in working capital available at the end of 1975—a figure several times the amount of working capital available to all the other firms in the industry combined.

The irony is further compounded in that IBM, which has the capital, is the only firm that doesn't need it. IBM's wave of leased equipment acts as the firm's very own private bank, churning up seemingly endless supplies of money. The last time IBM had to go outside the firm to raise funds was in the mid-1960s when it was faced with the extraordinary expense of funding the 360 Series.

Should IBM decide to move aggressively in the data communications area—and should governmental regulatory agencies permit it—then that \$4.7 billion in working capital should be enough to fund IBM's activities in data communications and telecommunications.

Even AT&T would be no match for the mighty IBM bank. Ma Bell's relatively easy accounting methods, in addition to other factors, mean that the telephone giant must acquire capital for growth by going to the country's equity markets which have been severely strained in the past few years.

The equity markets, or more specifically, the stock markets, have been playing a quiet, and often troubling role in recent years in the computer industry which ultimately receives its funding

from the sale of public stock or the hope of selling stock to the public. Once again, IBM is Point Omega.

A religion

Ten and 15 years ago, IBM stock was often referred to as a religion and small wonder: anyone who invested \$10,000 in the stock in 1950 found that it was worth a quarter of a million dollars 12 years later. IBM, it was said, was an acronym for "I Buy Money."

Likewise, IBM competitors, all seeking to be "the next IBM," often saw their stocks soar into the stratosphere. Control Data sold at \$50 at 150 times earnings and the stock of Ross Perot's Electronic Data Systems sailed into the \$100s, sporting a price-earnings ratio, if traditional accounting methods were used, of 200.

All that has changed now, however. IBM's stock traded higher in 1967 than it did in 1976, and Control Data and EDS stocks long ago came back to earth with dull thuds that often flattened the wallets of investors.

One result is that there hasn't been much equity raised by computer firms in the past few years. The younger, rapidly growing companies have often had to mortgage away their assets to banks—and sometimes suffer the consequences like Cambridge Memories—and many promising computer and computer-related companies have had to be acquired by larger, less imaginative, but more liquid companies. All this has blunted competition in the industry.

The stock market difficulties have undoubtedly been exacerbated by the restrictive monetary policies of the Federal Reserve Board under Chairman Arthur Burns, who slammed the brakes on the money supply with such force that it sent the nation's stock markets crashing through the windshield. Many economists believe that Burns' actions may have helped dampen inflation—his goal—but the structure of the capital markets may have suffered permanent damage in the process.

The foot soldier

In this bleak atmosphere in which many investors suffered nearly as much during the 1970s as veterans of the depression stock market collapse, it is small wonder that the individual investor—the foot soldier of the country's financial markets, and, thus the financial underpinning of the computer industry—feels like cannon fodder.

In 1975, the New York Stock Exchange reported that the numbers of stockholders declined for the first time in 23 years and the decline was substantial—more than 18% since 1970.

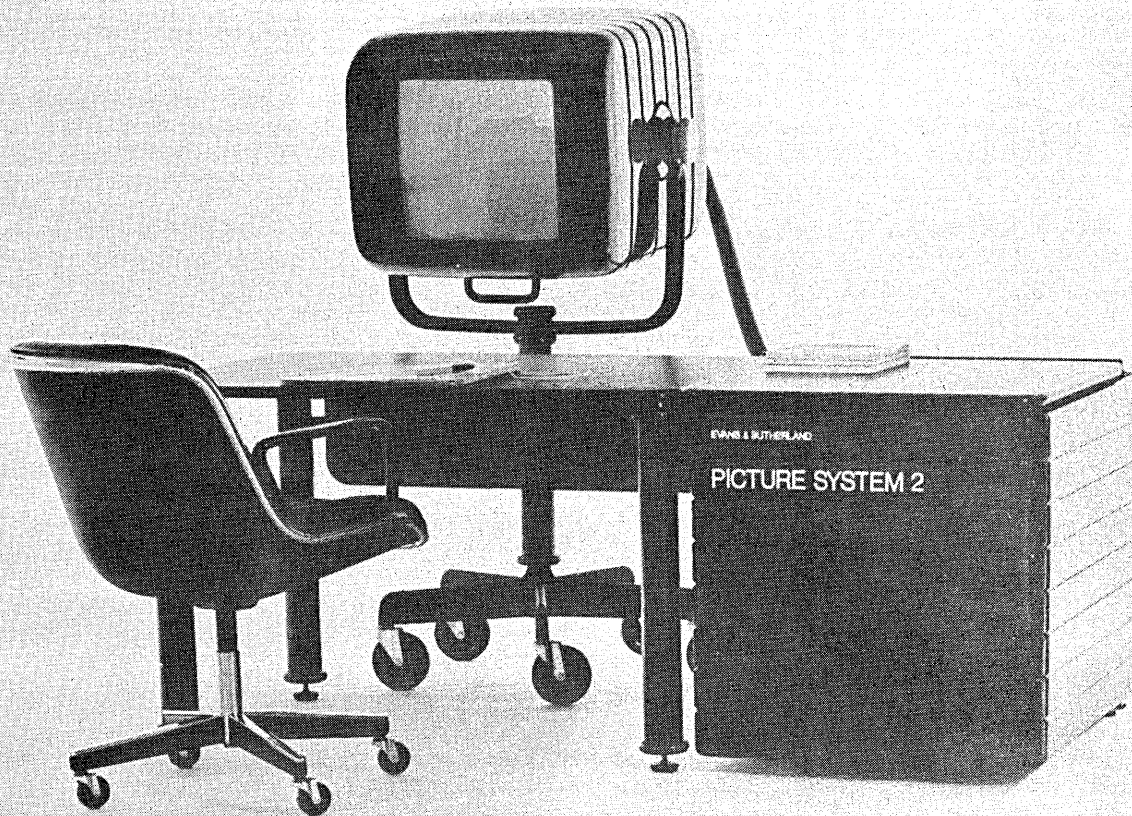

standing alone...

Introducing Picture System 2. Far ahead of its predecessors and its competition, it sets a new standard for high performance computer graphic systems. Following a long-standing Evans & Sutherland tradition, Picture System 2 is a total computer graphics package, which includes the most advanced high performance hardware, powerful software, and outstanding reliability.

Complete software compatibility between Picture System 2 and our earlier Picture System is a result of Evans & Sutherland's continuing commitment to its customers. Picture System 2 is available for delivery in less than 90 days. Arrange for a demonstration today.

Contact: Vel S. Casler, Director of Marketing, Evans & Sutherland Computer Corporation, 580 Arapeen Drive, P. O. Box 8700, Salt Lake City, Utah 84108. Telephone: (801) 582-5847, TELEX 389424 • In Europe: James F. Callan, Manager, European Sales and Service Office, Redifon Flight Simulation, Ltd., Gatwick Road, Crawley Sussex, RH10 2RL, ENGLAND. Telephone: Crawley (293) 511504, TELEX 87327

EVANS & SUTHERLAND

news in perspective

Worse, The Securities Industry Assn. reported earlier this summer that the trend is continuing and even appears to be accelerating in spite of the fact that the stock markets have gone up in the past year. Another indication of the disillusionment of individual investors appeared this summer when figures were announced that revealed that investor redemptions of mutual funds were continuing at a high rate and were acting as a drain on the stock markets.

A return to the industry of the instant computer millionaire.

At the same time, New York Stock Exchange and Securities and Exchange Commission reports indicate that insider sales of stock owned by corporate officers and directors have been rising, indicating that the insiders are unloading their cheaper unregistered stock on the open market. This action, too, tends to dampen the equity markets.

Still, the picture of outside financing of the computer industry isn't all gloom and doom.

One Wall Street computer analyst, Eugene K. Collins of Evans & Co., thinks that IBM stock will perform better in the future and will tend to pull the

stocks of other computer firms along too.

"I think that IBM stock will do better in the future," says Collins. "Wall Street is already rethinking the composition of IBM's price/earnings ratio. If the company demonstrates that it can continue its fine sales and profit growth, then that will be bullish for IBM stock."

Into communications

Collins also believes that IBM will move more forcefully into the increasingly glamorous area of data communications and, as IBM's moves become more apparent here, it will make the firm's stock more attractive. In addition, Collins looks for some resolution of IBM's various antitrust actions sooner or later and when this does occur, he feels it will benefit the company's stock.

Another bright note has been the revival of the new issues market. A few computer companies have "gone public" in 1976 and several more are waiting in the wings, hoping to make an initial sale of stock to the public.

The best known to go public was the Amdahl Corp. which sold more than one million shares to the public at \$27.50 a share (Page 186). That price, however,

was lower than the \$35 a share the company had initially been hoping to receive and lower than the \$28 a share it was once slated to receive for shares it planned to sell in a 1973 offering that was aborted. (Nevertheless, the offering signaled the return to the industry of the instant computer millionaire. Gene M. Amdahl and Eugene R. White sold 33,000 and 25,000 shares, respectively, of their stock to the public. According to the company prospectus, Dr. Amdahl purchased his stock for about 5¢ a share.)

Amdahl posted healthy profits when it went public, as did a few of the other firms who have gone to the new issues market this year—Documation and Four Phase Systems. One firm that went public this year without profits was Cray Research which sold stock largely on the basis of the reputation of its founder, Seymour Cray, who developed the super computers sold by the Control Data Corp.

While the new issues market is beginning to show signs of encouragement, however, the industry's corporate disasters continue to dwarf the small successes. The Singer Co.'s recent \$400 million loss in computers and the Wyly Corp.'s decision to cease operations at its Data Transmission Co. (Page 186)—a move which could lead to a \$100 million loss—are good cases in point.

—W. David Gardner

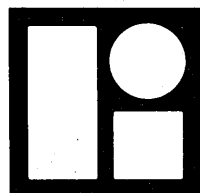

Litton

370/158

VS2 - HASP - TSO
DOS EMULATION (DUO)

APPLICATION AREAS:

FINANCIAL
DATA BASE
ENGINEERING
DATA MANAGEMENT
STATISTICAL/MATHEMATICAL
SIMULATION

ALL SYSTEMS AVAILABLE
24-HOURS PER DAY

LITTON COMPUTER SERVICES

1831 Michael Faraday Drive
Reston, Virginia 22090

(703) 471-9200

RESPONSE TIME PROBLEMS?

Get the REAL response time with a TERMINAL RESPONSE TIME MONITOR. This is a hardware monitor that measures the average, minimum, and maximum RESPONSE TIME along with the number of transactions. Terminal connection is by a front panel optical coupler which eliminates internal probe points. Operation is unattended and automatic.

Price: \$950.00

Delivery: Stock to 30 Days

For more information contact:

QUESTRONICS INC.
3596 South 300 West
Salt Lake City, Utah 84115
(801) 262-9923

Now you can help your computer people interface as efficiently as your computer equipment!

Find out how...at EDP LEADERSHIP: Integration of Communicating- Cooperating-Motivating

The EDP users in your company know what they want — and your Systems, Programming and Operations people are certainly able to implement it.

So it's aggravating when things get fouled up because of breakdowns in communication.

And what about the *motivation* of your computer people? How do you spur them on to maximum efforts when traditional motivational programs have proven to be hit-or-miss affairs? (Even when a program has been mildly *successful* in the *short* run, it's usually *failed* in the *long* run.)

Well, now there's a revolutionary way of solving *both* of these problems.

Our 3-day EDP LEADERSHIP briefing/workshop will give you proven techniques for improving communication and motivation dramatically. The meeting will be held in New York November 22-24, 1976.

Using lectures, exercises, and role-playing sessions, a highly trained staff from the Institute for Motivating Academic, Social and Political Achievement (IMASPA) will show you how to use motivation as a "call to action" — one your people will respond to positively and easily. How to mend any broken links in the chain of communication between user, Systems, Programming and Operations. How to "re-personalize" the sometimes de-personalizing world of EDP. And much more.

Our Management Systems Divisions offers some 24 other EDP-related programs as well — including meetings on mini-computers, teleprocessing, project

management, systems analysis and design, EDP auditing, and microfilm systems.

Phone us for action. To register for the EDP leadership meeting — or to get complete information on any of our valuable programs — phone Program Director Alan Freedman at **212-586-8100, extension 507**. Or write him at The American Management Associations, 135 West 50th Street, New York, N. Y. 10020. Or mail him the coupon.

It'll be smooth going from then on.

	MANAGEMENT SYSTEMS DIVISION
	The American Management Associations
135 W. 50th St., New York, N. Y. 10020	
Att: Alan Freedman	
<input type="checkbox"/> Please send complete information on Briefing Session #6377-02DA, EDP LEADERSHIP: INTEGRATION OF COMMUNICATING-COOPERATING-MOTIVATING, to be held November 22-24, 1976, in New York.	
<input type="checkbox"/> Please register me for the above briefing.	
<input type="checkbox"/> Please send information on your programs in the following systems areas:	

Name _____	
Title _____	
Company _____	
Street _____	
City _____ State _____ Zip _____	
6-8479X	

End of a Dream: Fed up with the telephone company's disregard for computer customers, Sam Wyly in 1968 launched his own company to move data digitally. Though pressed throughout its short life with huge cash problems, Data Transmission Corp. (DATRAN) was launched early last year and it turned out to be the most impressive, fastest and least expensive to use data network. In its first year, it had lined up 130 customers and had revenues of \$1.4 million. But the cost was high: Wyly sold off a lot of profitable operations, including its successful remote batch terminal line, and put the entire



company into hock to Swiss industrialist Walter Haefner, in return for some \$40 million in loans. And it had fierce—and in some cases alleged unfair—competition from AT&T which also announced its own digital data transmission service. Finally, on Aug. 20, its negotiations to merge or sell the company having fallen apart, the company closed its doors in Vienna, Va. and arranged to apportion its customers to other carriers. But not before filing a \$285 million treble damages suit against Ma Bell for having “engaged in deceptive marketing techniques.”

It's Fair Says the Judge: A Federal Communications Commission official has decided that American Telephone & Telegraph Co.'s long distance tolls are fair in rejecting recommendations by FCC staff members that AT&T be forced to divest itself of Western Electric Co. and Bell Laboratories Inc. The decision was handed down by FCC administrative law Judge David I. Kraushear. Although an FCC employee, he is independent of the agency's trial staff, which had recommended a refund to Bell customers of \$1.6 million in alleged overcharges for the period 1971-1975. The staff had proposed also that the com-

mission urge Congress to break up AT&T in order to encourage competition in the telephone industry.

Counterclaim Filed: AT&T has filed a counterclaim against three Litton Industries subsidiaries which have sued it on antitrust charges. Ma Bell charges the Litton units with arranging “kickbacks, bribes and other improper or unlawful payments” to customer representatives and public officials. The Litton suit seeks \$330 million in trebled damages and charges AT&T with antitrust violations in the interconnect market. The AT&T counterclaim, filed in U. S. District Court in New York City, also claims the Litton subsidiaries “improperly or unlawfully obtained proprietary data” belonging to Bell. The subsidiaries, Litton Systems, Inc., Litton Business Telephone Systems and Litton Business Systems have also named Western Electric, Bell Laboratories and seven Bell system operating companies in their suit.

A Week Late; \$5.00 Less: Amdahl Corp. completed its first public stock offering Aug. 12, a week late and for \$5.00 less per share than had been expected. The stock was offered at \$27.50 per share through an 88 member underwriting syndicate headed by First Boston Corp. Amdahl originally had expected to realize \$32.50 a share for the 1,000,000 shares offered. The week's delay in the offering was the result of the Securities and Exchange Commission's ordering the firm to issue an amended prospectus because of an accounting problem stemming from a July shipment of a 470V/6 computer to Canadian Pacific. Earlier last month the Sunnyvale, Calif. firm doubled its Canadian sales to four. It installed a 4 megabyte 470V/6 for L'Industrielle Services Techniques Inc., Montreal, and received a \$4.65 million contract from the federal government for a 470V/6 to replace a leased IBM 370/168.

Canadian Connection: Tymshare, Inc. and the Trans-Canada Telephone System said they have reached an agreement to interconnect Canada's Datapac packet switched network with TYMNET, Tymshare's international data network. The firms said this is the first international linking of packet-mode networks for commercial use in the world. It will give customers in Canada direct packet-mode access to a large universe of computers and data bases in the U.S.

TYMNET subscribers in the U.S. will be able to interconnect to Canadian computers tied to Datapac. Andrew McMahon, director of the computer communications group for Trans-Canada, said the Datapac network is now being field tested and will be put into operation later this year. Full interconnection with TYMNET in a packet-switched mode will be implemented next year.

A French Connection: Tymshare, Inc., Cupertino, Calif. based computer services firm, said it has completed previously announced arrangements for an investment in SLIGOS S.A., and for increased ownership in its CEGOS-Tymshare affiliate. Both SLIGOS and CEGOS-Tymshare are based in Paris, France, and provide computer services. Tymshare has purchased an 11% interest in SLIGOS for an investment of approximately \$1.5 million cash. In addition, the firm made a loan of approximately \$1.5 million, which is convertible at Tymshare's option, into an additional nine percent equity interest in SLIGOS. CEGOS-Tymshare has been an affiliate of the California company since 1969. Tymshare increased its ownership in the French concern from 20% to 45% for approximately \$1.1 million cash.

United Buys Standard: United Telecommunications, Inc. has signed a definitive agreement with Standard Computer Corp. for acquisition of Standard via an exchange of stock. Standard, headquartered in San Pedro, Calif., provides time-sharing and remote computing services through its wholly owned subsidiary, Standard Information Systems, Inc., Wellesley Hills, Mass. United Telecom is a holding company which operates the United Telephone System, the nation's third largest telephone system serving 3.5 million telephones and more than 2,900 communities in 21 states.

Intel Acquisition: Intel Corp., San Francisco, and Computer Dimensions, Inc., Dallas, agreed in principle to Intel's acquisition of Computer Dimensions for Intel common stock. Computer Dimensions, which provides specialized data processing services to the automotive, insurance and financial credit union industries through a national network of data centers and communications facilities, would become part of Intel's Data Services Group.

Torrance Re-Ups: The city of Torrance, Calif., has renewed its computer facilities management contract with Computer Sciences Corp. a year ahead of schedule. The new four year contract is for \$1 million plus systems development work. The city first signed on with CSC in 1974 for management of municipal data processing operations and the development of new information systems. The early renewal, City Manager Ed Ferraro said, will give the city a fixed price on data processing operations into 1980 for budget planning purposes. He said it also will ensure the successful development of new information systems already underway.

Mergers Hold Even: Chicago based merger consultants, W. T. Grimm & Co., said merger announcements in the computer manufacturing and services field in the first half of 1976, totaled 27, the same as the 27 recorded in the first half of 1975. For all industries, merger activity totaled 1,270 transactions, up 5% from a year earlier. Means of payment for companies in the computer group, the Grimm study said, followed the pattern for overall industry. Of the 18 transactions on which price data was available, nine were for cash, seven for stock, and two for a combination of cash, stock and/or debt. Publicly held sellers accounted for six of the computer transactions compared with eleven for the first half of 1975.

New President at NCR: NCR Corp. has been without a No. 2 man since William S. Anderson, 57, then president and Chief Executive Officer assumed the title of chairman as well. Last month, NCR announced a new president: Charles E. Exley, Jr., who resigned from Burroughs Corp. where he was



executive vice president for finance. He'll also become an NCR director and a member of the board. Anderson will retain the titles of Chairman and CEO. Exley, who is 46, spent 22 years with Burroughs and was the company's youngest senior executive. He is considered a top financial expert in the computer industry.

SDC Orders From STC: Storage Technology Corp., Louisville, Colo., has re-

ceived a \$1 million order for its new computer disc storage equipment, Super Disc, from System Development Corp., Santa Monica, Calif. sdc said the newly ordered Super Disc will give it immediate access to all information in its bibliographic retrieval system. The new discs will replace lower capacity disc equipment which permitted access to only a portion of the total information in their system at any one time.

\$19 Million Sale: E-Systems, Dallas, paid \$19 million in cash to acquire NCR Corp.'s wholly owned subsidiary, Electronic Communications, Inc. (ECI), St. Petersburg, Fla. The new E-Systems subsidiary is engaged primarily in developing and producing military communications systems such as teleprinter equipment, telemetry data transmission systems, and mail processing systems. E-Systems is an international high technology company engaged in developing and manufacturing a broad range of electronic products and systems, including electronic warfare, communications, command and control, and guidance and control systems.

New Name, Place: Pertec Corp. has changed its name to Pertec Computer Corp. and its state of incorporation from California to Delaware. Ryal Poppa, president of the minicomputer peripheral equipment and data handling systems manufacturer said the

New... from Delta
DISPLAY AND STORAGE SYSTEM

Introducing the DELTA 4700: the data storage and handling system that reduces computer time, lowers data processing costs, and simplifies data handling for text editing, data entry, and data storage and retrieval applications.

- Store and access up to 1.25 million characters
- Up to 16 kilobytes of read/write memory (up to 64K option)
- Data manipulation, including Read/Write, Modify, Search and Copy.

The DELTA 4700 System also:

- Is backed by nationwide customer service in over 150 locations
- Offers compatibility with IBM 3740 formats
- Includes a confidence diskette for diagnostics
- Optionally contains a Disk Monitor System for assembly and text editing of programs, along with a separate terminal/disk debug package
- Is supplied with full documentation—hardware and software.

Contact us today for more information.

Delta Data Systems Corporation

Woodhaven Industrial Park
Cornwells Heights, PA 19020
(215) 639-9400

DELTA DATA SYSTEMS, LTD.
London 01-580-7621

Service in over 150 locations in the U.S. and 13 European countries and Canada

New... from Delta
COMPUTER COMPATIBLE DISPLAY

Introducing the DELTA 4050: the display terminal with polling discipline for BURROUGHS, HONEYWELL and other computers.

Use the DELTA 4050 for applications such as:

- Text editing
- Data entry
- Data retrieval
- Multi-format storage

The DELTA 4050 also:

- Is built for reliable, round-the-clock performance
- Is backed by nationwide service in over 150 locations
- Supports peripherals such as floppy disks and printers

Contact us today for more information.

For user programmability with polling discipline, ask about the DELTA 4550

Delta Data Systems Corporation

Woodhaven Industrial Park
Cornwells Heights, PA 19020
(215) 639-9400

DELTA DATA SYSTEMS, LTD.
London 01-580-7621

Service in over 150 locations in the U.S. and 13 European countries and Canada

News in Perspective BENCHMARKS . . .

name change "reflects the broadening of Pertec's business. With the acquisition of Computer Machinery Corp. in the last fiscal year, we now have a strong position in data entry. The proposed acquisition of ICOM, which serves the microprocessor and microcomputer-based subsystem industry, points to other new directions for Pertec." The company continues to be listed on the American Stock Exchange under the symbol PTK, but has applied for a change in symbol to PCC.

Univac Closes Plant: Sperry Univac is closing its Utica, N. Y. plant which was manufacturing 90/30 computers, key-punch equipment, card punches and readers, and printers. The firm said it would transfer 100 to 150 people and seek placement for the remaining 800 to 850. Employment at the plant has dwindled from a peak of 3,800 in the early 1970s when it was producing 9000 series computers and plated wire memories. Reason given for the closing was a "drastic" reduction in the need for plant space for manufacturing created by technological advances within the computer industry.

Honeywell Organizes Group: Honeywell Inc. has established a Page Printing System organization to capitalize on what it terms "the growing acceptance" of its high-speed, non-impact printer products. Ronald F. Borelli, a member of the page printing development program since its inception, was named to direct the new business venture. The Page Printing System is a minicomputer driven electrostatic non-impact printer capable of speeds of 12,000 or 18,000 lines per minute. Borelli has management direction over all engineering, manufacturing, supplies, home office product marketing and field marketing support activities for the new organization.

New Life at Stanford: A Chilean computer scientist, imprisoned in his native country for three years, is now free and at work in the computer science department of Stanford University. Fernando Flores, 33, was the administrator of economic affairs in the cabinet of the late Chilean president, Salvador Allende Gossens. He was imprisoned along with other Allende cabinet members during the Chilean military coup in September 1973. Other cabinet members were later

released but Flores, unexplainedly, was not. Members of the Stanford staff and Amnesty International were among those who worked for Flores' freedom but no reason was given for the decision to release him from the political prison. Flores is credited with being one of two men in the world who have successfully put a national government's entire economic plan onto a computer system.

Bright Outlook: A study by market researchers Frost & Sullivan Inc., New York City, finds the outlook for the U.S. semiconductor industry to be "extremely bright." Worldwide sales of semiconductors by U.S. manufacturers, at \$2.2 billion in 1975, will reach nearly \$3 billion this year and grow to \$4.6 billion by 1980 and \$5.1 billion by 1984, the study says. High density devices, especially microprocessors and memories, will account for most of the growth, the study shows, though the short term profits outlook for micros is uncertain. Discrete-type power transistors, rectifiers, field emission transmitters, microwave devices, and thyristors also will climb over the next decade, the 173-page study says, but the discrete device business overall will "remain relatively slack." *

C. Itoh Introduces Low Cost, Full Alpha-Numeric, Dot-Matrix Impact Printers

BOYSWEAR - NYLON JACKET	12.43
HOUSEWARES - MEAS. CUP	2.67
MENSWEAR - SWEATER	18.25
SUB TOTAL	33.35
TAX (8%)	2.00

TOTAL 35.35

AMOUNT TENDERED 40.00

CHANGE 4.65

THANK YOU... COME AGAIN
XYZ DEPARTMENT STORE

PRINTED BY

LRC 7040
MATRIX PR

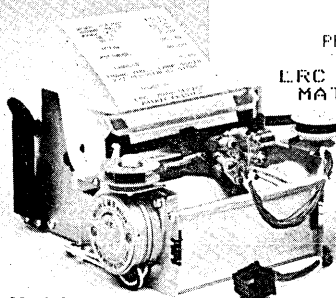

Model 7040

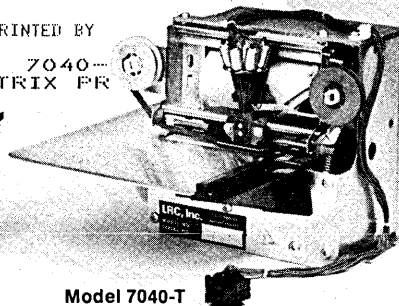

Model 7040-T

- Speed: 1.25 L/S (on 60 Hz)
- Print Line Capacity: 3 1/3"
- Media: Max. 3 7/8" Roll or ticket
- Multi-Copy Capability
- Print Solenoid Power: 40 VDC ± 10%
- 40-Column Capacity (at 12 characters to the inch)
- Motor(s): 100-125 VAC, 50/60 Hz
- Variable font and density capability under software control
- Simple electronic interface



C. ITOH ELECTRONICS, INC.

Los Angeles Office: 5301 Beethoven Street
Los Angeles, CA 90066
Tel: (213) 390-7778

New York Office: 280 Park Avenue
New York, N.Y. 10017
Tel: (212) 573-9456
573-9467

Developed and Manufactured by:
LRC, INC., RIVERTON, WYOMING, U.S.A.

New! \$1095 Fire Safe for small systems media

Now small systems users can have fire protection for valuable disks and tapes with Tab's DataGard™ fire safe. U. L.-rated to maintain a maximum internal temperature of 150° for one hour (85% maximum humidity), DataGard is designed in scale with small systems requirements. Outside dimensions are: height—39¹/₂" , width—32⁵/₈" , depth—39" .

The compact DataGard comes with casters and a textured off-white finish. Options include second door colors and a functional formica work top. The DataGard fire safe will economically store two 3348 Data Modules, ten 2315 Disk Cartridges or numerous other combinations of magnetic media including floppy disks, computer tape, microfilm, and cassettes.

For complete information, call your local Tab representative or write Tab Products Company, 2690 Hanover Street, Palo Alto, California 94304.

TAB
PRODUCTS CO

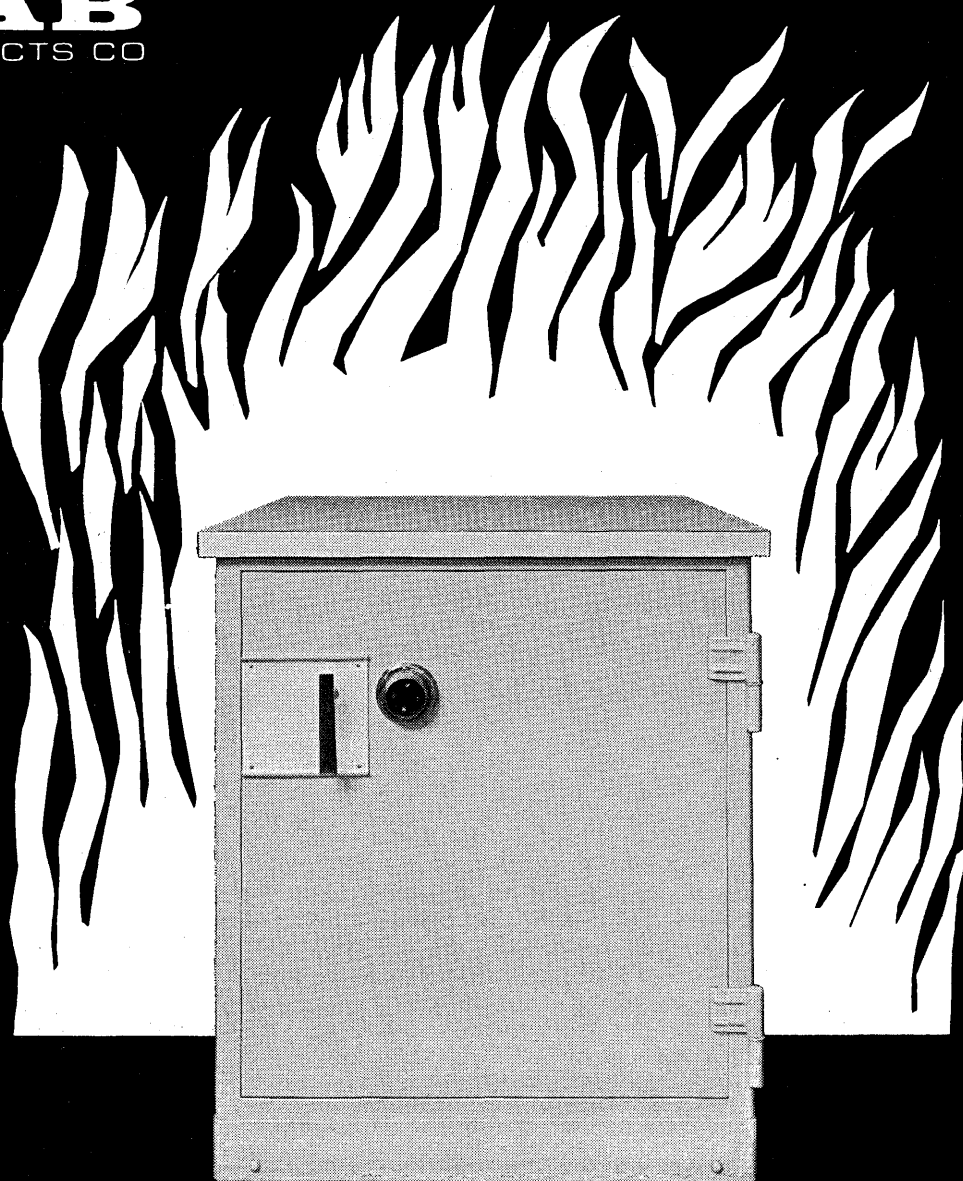

LOOK AHEAD

(Continued from page 18)

just stops giving quality and quantity in people it sends to the meeting," when it isn't pleased with the members' actions. The action, of course, doesn't affect Amdahl users who have other IBM equipment. But such groups as Texas A&M, which uses only IBM software with its Amdahl machine, is out.

SOMETHING NEW FOR EECO

Electronic Engineering Co. of Calif. (EECO), around since 1947 and best known as a producer of punched paper tape equipment, last got into a new field in 1970 when it introduced a Nova-based hotel reservations system. Now it's doing a new thing again. The company has purchased a design for a Teletype-compatible terminal from Soroc Inc., Los Angeles, and expects to have a prototype built by January and to begin marketing shortly thereafter. The terminals will be used in their hotel systems in addition to being offered to the oem market. The terminals will be pollable, something not common in the TTY-compatible field.

HE DIDN'T START A RESTAURANT BUT MAYBE SOMEDAY

Back in January, when he was board chairman of Basic/Four Corp., Al Cosentino had two consuming outside interests. One was hockey and the other, Italian food (January, p. 11). He was thinking of opening an Italian restaurant. He hasn't, though it's still in the back of his mind, and he isn't playing hockey any more either. He doesn't have the time. He's too busy with what he did start after leaving Basic/Four in February because of "a difference in philosophy with the parent company," Management Assistance Inc., which Cosentino had joined in 1962 to found its service arm, Sorbus. What he started was Business Systems Products Inc., almost next door to Basic/Four in Irvine, Calif. and destined to be a head on competitor when its two small business systems, Advisor II, starting at \$38,400 and Advisor III with a low price tag of \$65,800, this month. Says Cosentino of the small business computer market: "It's big enough for everyone."

COMPUTER SELLS CALCULATORS

It finally happened. A computer was advertised by Macy's department store in San Francisco, specifically in the calculator department. It was the Adam computer, a small business device developed by Logical Machines Corp., of Burlingame, Calif., the firm that had a to-do with women's libbers over a product brochure featuring a nude girl seated at the computer console. In the Macy's advertisement a head and shoulders photo showed a pretty girl biting on an apple. Adam, the computer that doesn't require a special computer language, was used in the four-day showing to knock out biorhythms...but particularly to promote calculator sales.

NEW WASHINGTON EDITOR

Linda J. Flato has joined Datamation magazine as Washington editor. She replaces Phil Hirsch who has left the magazine to publish Data Channels, a communications newsletter launched three years ago by Datamation. Ms. Flato previously was with Computer Decisions magazine and EDP Weekly in Washington.

RUMORS AND RAW RANDOM DATA

A distraught Datran salesman said his company's closing in August (page 186) reminded him vividly of the Consumer Communications Reform Act--the "Bell Bill" to eliminate competition in the communications industry. On Aug. 19, the day before Datran closed shop, he said, "If Datran closes tomorrow the Bell Bill, in intent, has been passed into law"...We hear Memorex should have a 3350 type disc drive out early next year that will support DOS and possibly OS, something the IBM original does not...While users are still cheering for the sharp price cuts IBM uncorked in its 138 and 148, the competitors are still groaning. The reason: potential new purchasers of competing equipment--candidates for Honeywell's level 66 and Univac's 90/80 and 1110, for instance--are holding back their orders for new equipment waiting for those companies to cut their prices too...Disciples of APL obviously include many youngsters. The advanced program for the 10th international APL conference in Ottawa, Sept. 22-24 lists both hotel rates and rates for a youth hostel--the hostel being a mile and a half away from the conference hotel in the renovated Nicholas Street jail...TRW's executive v.p. J. Sidney Webb, speaking last month about the appeal of data communications, said he suspects the 13¢ first-class postage was being spent in this way: 3¢ for transportation and 10¢ for storage.

S/370 Computer Leasing: 7 Ways to Avoid Costly Mistakes



When you lease a computer you should get more than just a computer. You should also get protection, flexibility and solid savings over the life of the lease. But many companies overlook the following critical points when they lease:

1. Early Termination—the Best Method?

The walkaway lease is most flexible. However, it is also the most expensive because it doesn't require any guarantee of "residual value" at termination. Consider the more economical approach. Lower your monthly expenditure by placing some "residual value" on your System/370 because it will have some market value during the next few years. OPM can help you evaluate the relative cost savings and will structure your lease accordingly.

2. ITC—Lessor or Lessee?

In order to attain a lower monthly payment, many companies give up the Investment Tax Credit. However, when the ITC is amortized over the term of the lease, it may often exceed the apparent monthly savings offered by an ITC Lessor lease.

3. Future Upgrade Provisions?

A lease should give you the ability to choose the simplest and most economical way of adding on memory, features or other changes. Your OPM lease will specify the future cost of such upgrades. But it will also allow you to select other methods of acquisition.

4. New Or Used Equipment?

Should you consider used equipment for all or part of your system requirements? OPM will explore with you the merits of leasing or subleasing used equipment.

5. Sublease and Assignment Provisions?

You may want to sublease or assign your system to another user. OPM allows you to do so at any time during your lease. And will even assist you in finding a suitable sublessee or assignee.

6. "Present Value"—The Great Equalizer.

Typically, you'll be faced with many alternative methods of acquisition. OPM will develop for you a "present value" analysis

that will take into account all possible variables. This analysis will show the true cost of the alternatives, and help you choose the acquisition method best suited for your company.

7. Will Your Leasing Co. Be Your Lessor?

Or will it simply be a broker for an unknown source? OPM will always remain your lessor. And will always maintain its responsibilities and interests in your lease and in your present and future computer needs.

Which leasing company is right for you? At OPM, we believe we are. Our dynamic, innovative and analytical approach to leasing has enabled us to become the fastest growing leasing company in the country. And one of the most satisfying aspects of our growth is the fact that so many of our clients return to us for their additional leasing requirements.

These are only seven key ways we can help you. Send in the coupon or call to find out more about us.

In New York, call (212) 747-0220
Outside N.Y.S., call toll free (800) 221-2674

OPM THE CUSTOM-LEASING PEOPLE

O.P.M. LEASING SERVICES, INC.
99 Wall Street, New York, N.Y. 10005

Yes, I'd like to know more about how OPM can answer my computer leasing needs.

- Have an OPM representative contact me.
 I would like a brochure about OPM.
 I would like to receive your quarterly newsletter, *OPM Leasing News*.

Name _____

Title _____ Tel. _____

Company _____

Address _____

City _____ State _____ Zip _____

DMS

OK, Bell.
OK, Codex.
OK, Milgo.
Fill in
the blanks.
Or we'll do it
for you.

Network Control is our business at Intertel.
We're very good at it.
In fact, we're the #1 company in network
control for on-line systems.

Naturally, we have competition.

Naturally, our competition says they have
network control for on-line systems, too.

Quite frankly, we think they don't.
We think it's just talk. Or wishful thinking.
Or both.
And we're going to prove it.

Here's our challenge.

If, within 30 days, they send us a specifica-
tion chart for their product, we'll be happy to
publish it in our next ad. *Free of charge.*
Right next to our own.

And you can decide for yourself who has
the best product.

On the other hand, if they don't respond,
we'll tell you about that, too. And you can
draw your own conclusions.

Either way, you'll be better informed about
network control.

In the meantime, if you want more informa-
tion about a *real* Network Control System,
one that can improve your system avail-
ability and cut downtime to an absolute
minimum, call us.

We're #1 in network control.

intertel

6 Ware/Brook Park
Burlington,
Massachusetts 01803
Tel: (617) 273-0950

Bell?

Codex?

Milgo?

Intertel.

Network Control System

First System Installed: 1973
Systems Installed: More than 100
Configuration: Works with any on-line system.

DIAGNOSTICS

Diagnose line, modem, terminal trouble	Yes
At all speeds, 1200 baud-9600 bps	Yes
Simultaneous with data transfer	Yes
In networks with multiplexers, concentrators	Yes
English language display	Yes
Real-Time line level monitor	Yes
Remote site assistance required	No
Meters, oscilloscopes required	No

RESTORAL

Bypass line failures	Yes
All automatic at remote sites	Yes
Dial backup at all speeds	Yes
1200 baud-9600 bps	Yes
On-line spare modem	Yes

OTHER FEATURES

Secondary Channel, simultaneous with data	Yes
Port Sharing	Yes
Modem Sharing	Yes
Bridging, analog and digital	Yes

letters

(Continued from page 8)

1. The Data Management Center, HEW purchased an encryption package called "Safeguard" from Computer Linguistics of Albany, N.Y. It is not a Bell Telephone developed package as far as we know. We are unaware of any relationship of this package to AT&T or an AT&T related company.

2. This routine is provided to users of our Data Center as a possible method of protecting data under the Privacy Act of 1974, and is now being tested by our users. We recommend it

in cases where DMC users must have better security than is provided by our normal procedures. In practice, only the actual users (or using group) know that data in their files are subject to Privacy Act restriction. Only the user can determine the depth of protection required.

Notice of the available software was distributed to our dp users, not to all Departmental employees as may be inferred by your article.

There are of course, other software packages on the market which may be more or less satisfactory than this particular package. Use of this software package by our center should not be construed as an endorsement by HEW

of this particular package nor of a requirement to encrypt privacy data.

OLIVER W. CAIRNS
Director, Data Management
Center
Office of the Secretary
Department of Health, Education,
and Welfare
Washington, D.C.

We believed that Safeguard was originally developed by Bell Labs, and that the package then found its way into the private sector. In checking, we called Computer Linguistics, the company that sold Safeguard to HEW; that company obtained the package from a firm called Digital Solutions which it acquired "several years ago." The actual origin of the package, it seems, is unknown.

As to HEW's distribution of its notice, we think it clear, in context, that we meant dp employees.

Low-down terminology

The literature on top-down programming has finally hit bottom with Dennis Geller's "How Many Directions Is Top-Down?" (June, p. 109). Such nonsense phrases as "doing top-down bottom-up" and "upside-down stubs" don't enlighten—they merely confuse. DATAMATION does a real disservice to its readers by printing articles with such reckless unconcern for meaning.

This is not to criticize the ideas presented in the article; they're good. It's just the terminology that's awful.

JAY A. SULLIVAN
Agoura, California

Structured assembler

While Capt. Rieks ("Structured Programming in Assembler Language," July, p. 79) mentions in passing that other macro packages facilitating structured programming in assembler language exist, he fails to mention the possibility of preprocessors. Preprocessors have an advantage over macro packages in that they are not limited to providing those facilities which can be implemented as macros. At NIH we are using a preprocessor (called ALP) for the IBM 370 Assembler which provides the facilities that are difficult or impossible to implement in a macro package; some of them are:

- more civilized syntax (similar to PL/1 or Algol)
- no special notation for instructions in predicates
- boolean operations in predicates, including nested parentheses
- nesting level shown on listing

ALP also includes several highly useful facilities which are possible in macro packages but were not mentioned in the article. Some examples are:

- CASE statement
- SELECT statement (generalized IF)

(Continued on page 198)

Super. because it's sonic

graf/pen™ graphic digitizer

It's the supersonic digitizer. It uses sound as its ranging medium. Which makes it more flexible to use. And more reliable.

Use it free of tablet. In working areas up to 6 foot square. In two or three dimensional applications.

Use graf/pen to eliminate tedious keyboard entry. It traces any form of graphic material into digital intelligence. Its limitless alphanumeric capability sets up streamlined business and inventory control systems.

Graf/pen is faster. More accurate.

It interfaces to virtually any minicomputer, programmable calculator, RS-232 device or off-line system.

Write. Or call Rolf Kates, our vp/marketing. Today. Ask him to explain fully how graf/pen got to be super. By being sonic.

SAC SCIENCE
ACCESSORIES
CORPORATION

970 Kings Highway West, Southport, Connecticut 06490
(203) 255-1526

CIRCLE 144 ON READER CARD

Cut your shipping costs in half.

Use big air freight containers and get United's "Daylight Savings."

Ship 3,000 pounds for the cost of 1,500 pounds.

We call this United's "Daylight Savings." You can save 50% or more on high density shipments. We figure the rates point-to-point, per container. So the more weight you load in each container, the less you pay per hundredweight.

Save all day.

To get your "Daylight Savings" rate, just get your shipment to us between 4 a.m. and 4 p.m.—our least busy time. All you do is load our big lower deck container and give it to us—we'll reward you with our big discount.

More widebody lift, more widebody destinations.

You've got the world's largest widebody fleet going for you at United. That means more destinations to choose from, more backup lift when you need it. In a word—reliability.

The denser your freight, the lower your rate.

United's "Daylight Savings" rates from New York City, for example:

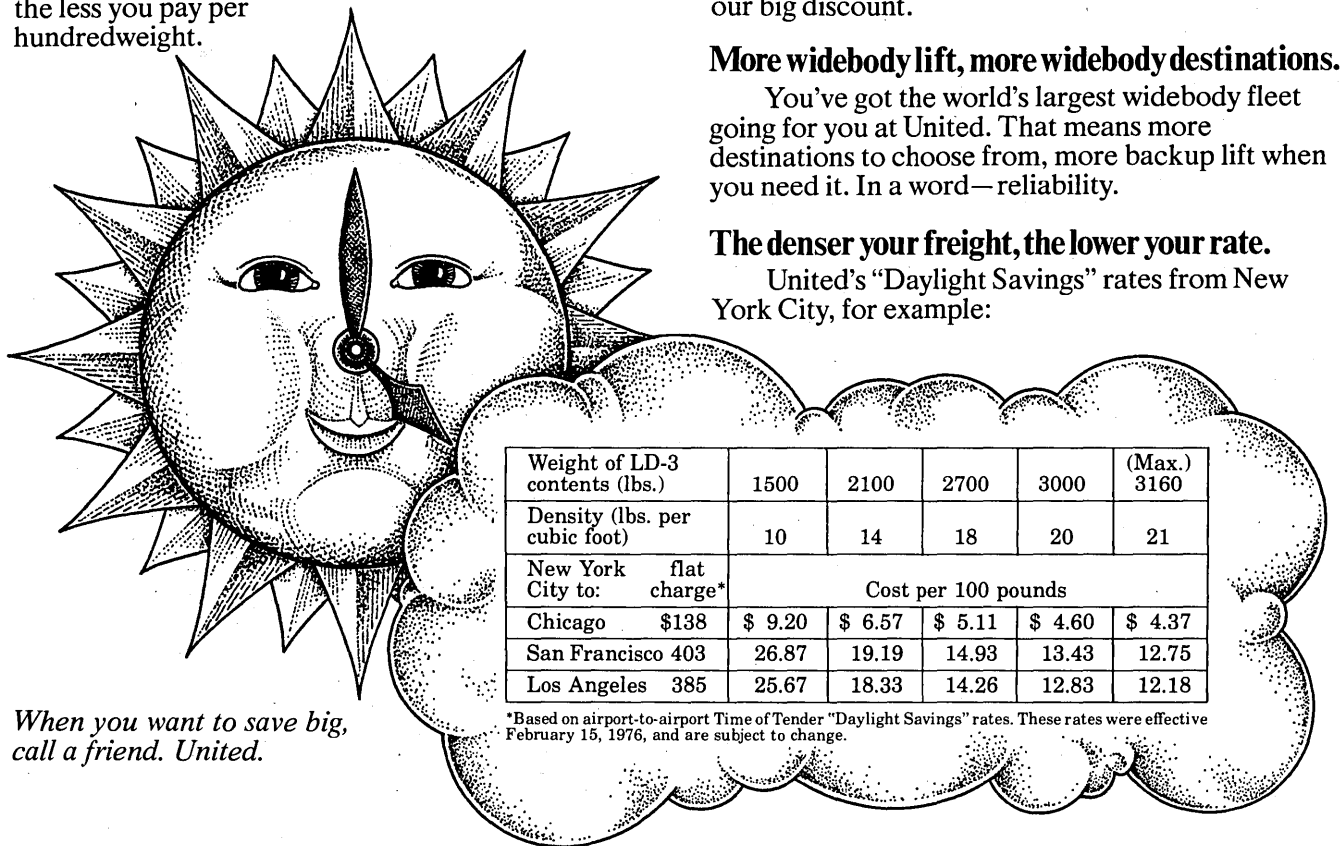

Weight of LD-3 contents (lbs.)	1500	2100	2700	3000	(Max.) 3160	
Density (lbs. per cubic foot)	10	14	18	20	21	
New York City to:	flat charge* Cost per 100 pounds					
Chicago	\$138	\$ 9.20	\$ 6.57	\$ 5.11	\$ 4.60	\$ 4.37
San Francisco	403	26.87	19.19	14.93	13.43	12.75
Los Angeles	385	25.67	18.33	14.26	12.83	12.18

*Based on airport-to-airport Time of Tender "Daylight Savings" rates. These rates were effective February 15, 1976, and are subject to change.

When you want to save big, call a friend. United.

No.1 in the U.S. sky

UNITED AIRLINES CARGO

You're fast asleep—dreaming about native life in Tahiti—when the phone awakens you at 3 a.m. It's your computer operator. The tape's hung up. And your chances of getting more sleep are hung out to dry.

Sound familiar? It should. It's a scene that's repeated often enough. The average tape contains errors that cost your company money, and you a lot of rest.

If you'd only called your Data Devices International sales rep last week, the tape would have been humming and you would have been enjoying sweet dreams.

DDI's Mark IV Magnetic Tape Cleaner helps you maintain your magnetic tape library at peak efficiency. Ridding tapes of dirt, foreign particles and redeposited oxide lumps that can turn them into a nightmare.

All this without affecting the information on the tape. And it's the only tape cleaner with lifetime guaranteed self-sharpening blades, plus a vacuum system. Which means you don't ever have to fiddle with replacement blades or tissues.

DDI makes a complete line of media maintenance equipment, from the low cost Mark III Tape Cleaner to the Century 21 Tape Cleaner/Evaluator and CMS IV Disc Cartridge Cleaner/Verifier. Circle the reader service card number and we'll send you the name of your local Data Devices rep, plus complete details on how you can justify the lease or purchase of the latest in media maintenance devices. You'll sleep better knowing you did.

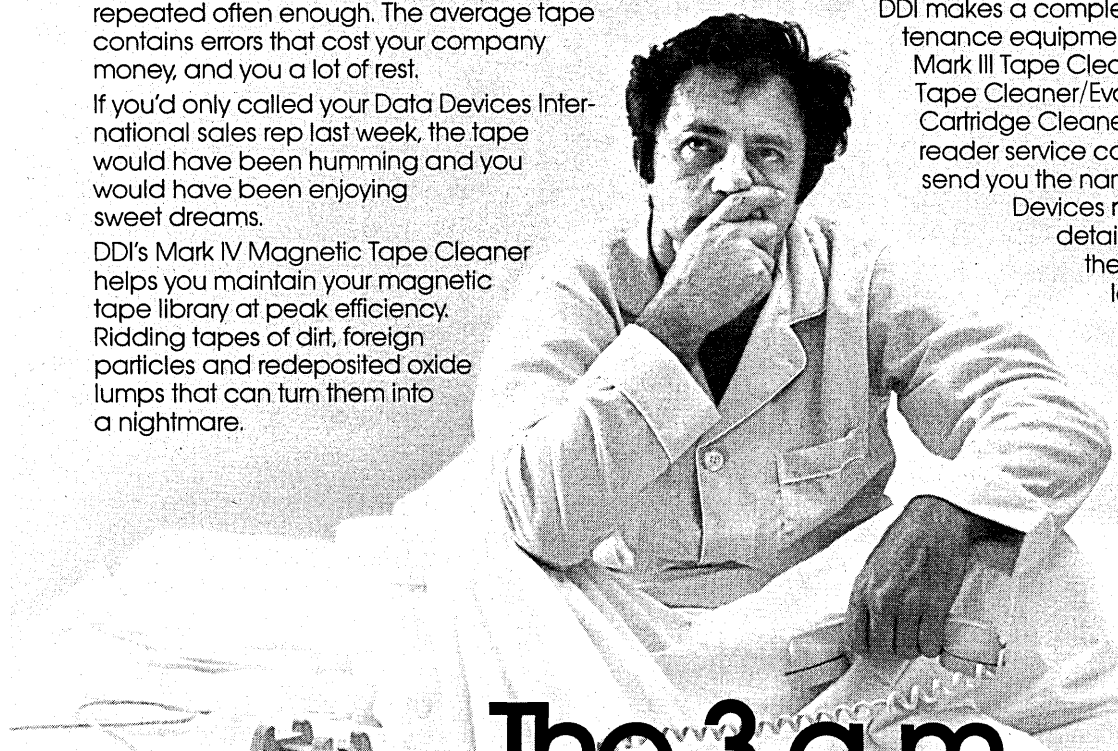

The 3 a.m. shutdown doesn't have to be a way of life for the D.P. Manager.

Data Devices

The Economic Ones.
Make Us Prove It.
Write.

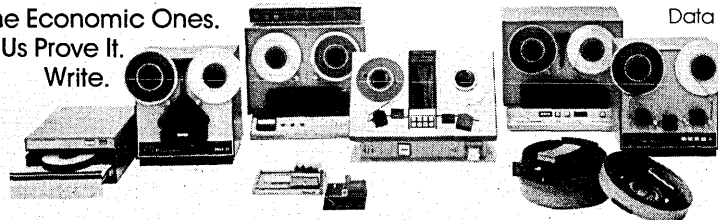

Data Devices International, Inc.
6301 De Soto Avenue
Woodland Hills, Ca. 91364
(213) 884-5500

Today the world is marching to a different drum.

***The Zeta 3600 ...
no drum plotter is faster,
more accurate, more versatile.***

Once, large plotters meant CalComp. No longer.

Today, more and more people with big plotting needs are coming to the Zeta 3600—where they get up to 4,000 steps per second off-line, 3,000 on-line. That means speed up to 14.14 ips with an accuracy that's truly astounding. The 3600's four pens each plot an area 34 inches by 120 feet. Increment size is 0.0025 inches. What's more, the cost is far less than CalComp's big drum.

For remote users, our remarkable 3640 version plots 3,240 steps per second. All that's needed is a 30 or 120 cps telephone hookup to a central computer.

Standard incremental plotting routines, using a 6-bit output command, generate the plots — creating length vectors in $\pm X$, $\pm Y$, Pen Up, and Pen Down movements.

Modular IC construction keeps seldom called for maintenance quick and easy. Write us today for free lit. Better yet, march to your phone. Zeta Research, 1043 Stuart Street, Lafayette, CA 94549. (415) 284-5200.

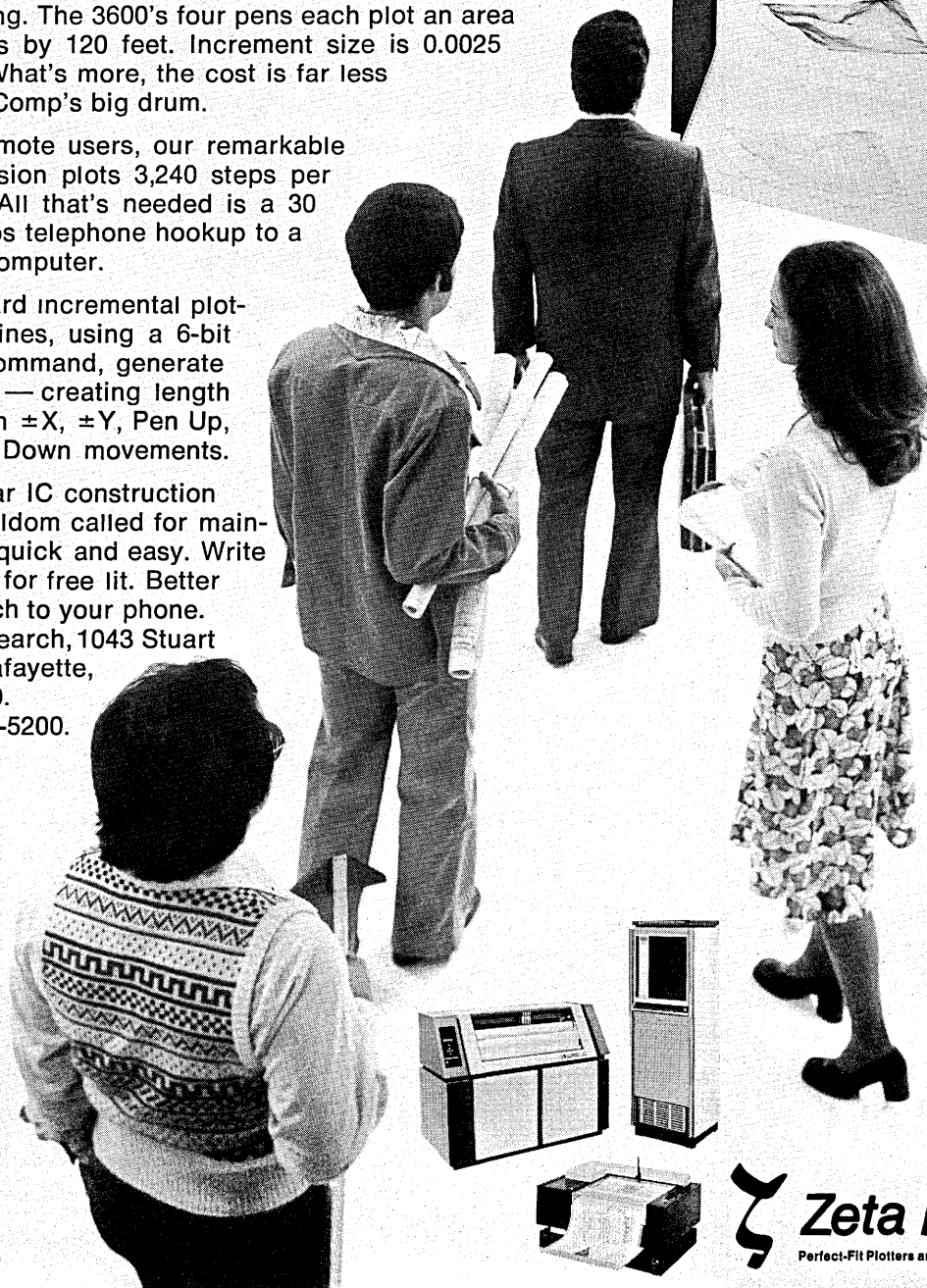
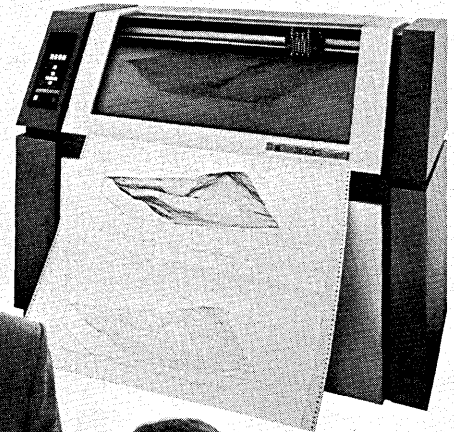

Zeta Research

Perfect-Fit Plotters and Systems For Every Need.

letters

(Continued from page 194)

- EXIT statement (premature exit from a loop)
- NEXT statement (advance to next iteration of loop)

ALP is not the only preprocessor for assembler language in existence. In fact, it is a major enhancement (done at NIH) of AL, a preprocessor developed by Edward C. Haines at Mitre Corp. Other preprocessors exist as well,



although preprocessors are not as common as macro packages.

I also have a point to make about higher level system implementation languages. Such languages would be better than assembler language for many applications which cannot be

coded in a normal higher level language. However, the sad fact is that most IBM installations (at least) do not have one available. IBM refuses to release its PL/S (which is not an especially good language anyway), and nothing else has gained wide acceptance on IBM hardware.

In any case, assembler language still has a place since many higher level systems implementation languages impose restrictions on procedure linkage, storage allocation of local variables, and storage allocation of compiled code which are not acceptable for some systems, especially those involving implementation of multiprogramming dispatchers.

ROGER FAJMAN
*Department of Health, Education,
and Welfare
Public Health Service
National Institutes of Health
Bethesda, Maryland*

After having read theoretical articles on structured programming until my eyes are bleeding, it is refreshing to read something that is practical and useful.

R. BRUCE McCORMICK
*Computer Systems Consultant
Rijswijk
The Netherlands*

A thank you

I want to say "Thank you" for placing a photograph showing that deaf people had the opportunity to participate at the NCC (July, p. 100) when the ACM's SIGCAPH (Special Interest Group on Computers and the Physically Handicapped) provided sign language interpreters.

This was my first professional experience to be able to "hear" and understand what the speakers had to say. Thanks to ACM's SIGCAPH and Steven Jamison, Vice Chairman for the Deaf.

PHILIP N. MOOS
*Lead Application Programmer
Rutgers University
New Brunswick, New Jersey*

DATAMATION welcomes correspondence about the computer industry and its effect on society, as well as comments on the contents of this publication. Letters should be typed and limited in length to 250 words, if possible. We reserve the right to edit or select excerpts from letters submitted to us. Write to 1801 S. La Cienega Blvd., Los Angeles, CA 90035.

THE LINK TO YOUR SYSTEM - - - GNT Automatic Paper Tape Equipment

Our Data Products Division has developed a complete range of peripherals designed to suit most systems and flexible enough to meet your needs.

From our programme we present

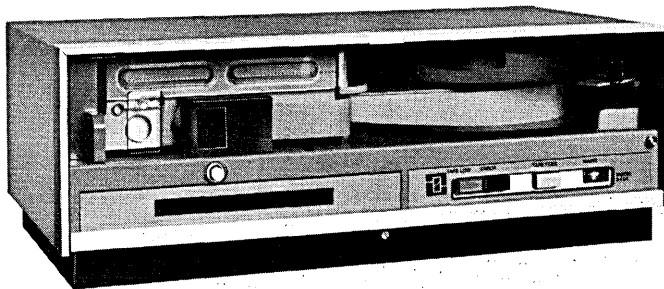

MODEL 3406
the new self-winding Paper Tape Station
Model 3406 has automatic paper tape loading and incorporates MOS/TTL/DTL handshaking interface and integral power supply.

OTHER OUTSTANDING
GNTA PRODUCTS INCLUDE:

- Model 26** Photoelectric Readers. Up to 500 ch./sec. Primarily intended as input devices for minicomputers.
- Model 34** Data Punch. Up to 70 ch/sec. Well proven - over 20,000 units installed to date. Received Danish Design Award. ALSO AVAILABLE AS SUB-ASSEMBLY PUNCH MECHANISM.
- Model 3424** Paper Tape Punch Station. Table Top Unit With TTL Logic and Power Supply.

For further information contact:

GNT AUTOMATIC

USA: GNT AUTOMATIC INC - 440, Totten Pond Road, Waltham - Mass. 02154
Phone: (617) 890 - 3305 - Telex: 923318
Corporate Headquarter, Denmark: GNT AUTOMATIC A/S - 6, Telefonvej,
DK-2860 Soeborg - Phone: (01) 69 51 88 - Telex: 27064



Visit us at
Wescon,
Los Angeles

Eleven compelling arguments for choosing a computerized personnel/payroll system from InSci

Compelling argument number one

InSci guarantees to get your system up and running fast. C.O.D. software can leave you holding the bag—not only for installation, but communicating the system's capabilities and potential to your personnel and payroll people. InSci installs it to your satisfaction—and then makes sure that the system is used to its fullest.



Compelling argument number two

Johns-Manville



Grinnell

We have satisfied Users. It is imperative that you buy a system that is in actual operation. Talk to users of our system. Visit the site and witness the system in action. Let their success guide you in your decision.

Compelling argument number three

InSci Systems are user-oriented. Every InSci package comes with full documentation and user's manuals that allow the Personnel and Payroll Departments to be masters of their own fate. Even our retrieval system (GRS) understands and speaks English. And, because of our experience in hundreds of installations in all kinds of companies, you are assured of an extraordinary level of competence in training. When we leave, you'll be in total control.

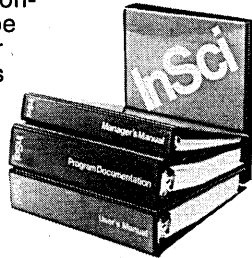

Compelling argument number four

The InSci Human Resource System is flexible and economical. It can grow with you. You are looking at the most flexible system available. This system provides the capability you need to support payroll and handle all of your personnel-related functions, including compliance with EEO, ERISA, and OSHA legislation, manpower planning, management development, salary and benefits administration, and health and safety programs.

Compelling argument number five

If you don't have a computer—or don't want to use yours—use ours! Manual handling of personnel/payroll information is inherently error-prone, and sometimes even dangerous! Contact our Systems Service Division. *With or without* a computer you need a Personnel/Payroll System from InSci.

Compelling argument number six

We keep informed—and keep you informed. We hold seminars and conferences to let you know what's happening and what's going to happen. At our Annual User's Conference you'll pick up valuable ideas on better ways to use your system. Management problems, EEO, ERISA, OSHA and other vital issues don't sneak up on you. (Right now we're keeping abreast of the Privacy issue—so you won't be caught unaware.)



Reply to Dept DA-9

Headquarters, Eastern Division
Systems Service Division
95 Chestnut Ridge Road
Montvale, New Jersey 07645
201-391-1600

Midwestern Division
2625 Butterfield Road
Oak Brook, Illinois 60521
312-986-1620

InSci Human Resource System

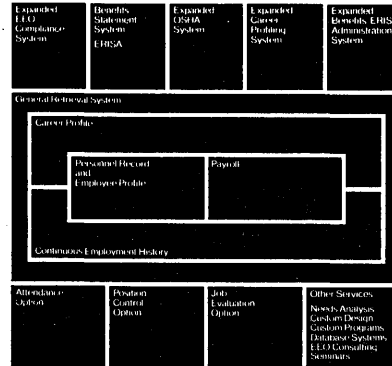

Compelling argument number seven

The background and experience of our personnel is outstanding. InSci has been designing systems for more than ten years in all types of environments—you don't have to "start from the beginning" with us. We'll study your problems and help you solve them. We know our business.

Compelling argument number eight

We stay on top of EEO, ERISA, OSHA, Privacy and other legislation companies can no longer ignore. Our systems are designed to handle the extraordinary amount of record keeping and reporting necessary for compliance. Your legal headaches in these areas can be a thing of the past.

Compelling argument number nine

InSci is a dynamic, financially secure company. Because of its corporate connection with CPC, one of the world's largest multi-national corporations, InSci enjoys an enviable security unique in the industry. Add to this, the remarkable growth InSci has experienced in the last eleven years—and you know you're dealing with a WINNER.

Compelling argument number ten

The value of our HRS is greater than the price. We will be sure that you get the system that meets your current needs at the best possible price. Then, as your needs grow, we will help you to expand your system as it becomes necessary.

Compelling argument number eleven

InSci looks ahead and stays ahead. This is a growing company of professionals who have tremendous pride in what they have accomplished and, more importantly—an insatiable desire to get better. We look forward to meeting you in person. Meanwhile, to learn more about ERISA, EEO, Privacy and other issues vital to management—send for our 5-Part Personnel Management Information Kit—free. It will tell you even more reasons why you should buy a personnel system from InSci.

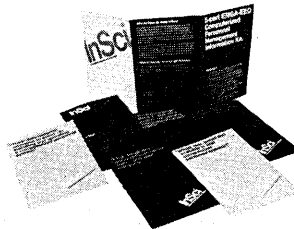

Do you know the company that publishes Datamation...

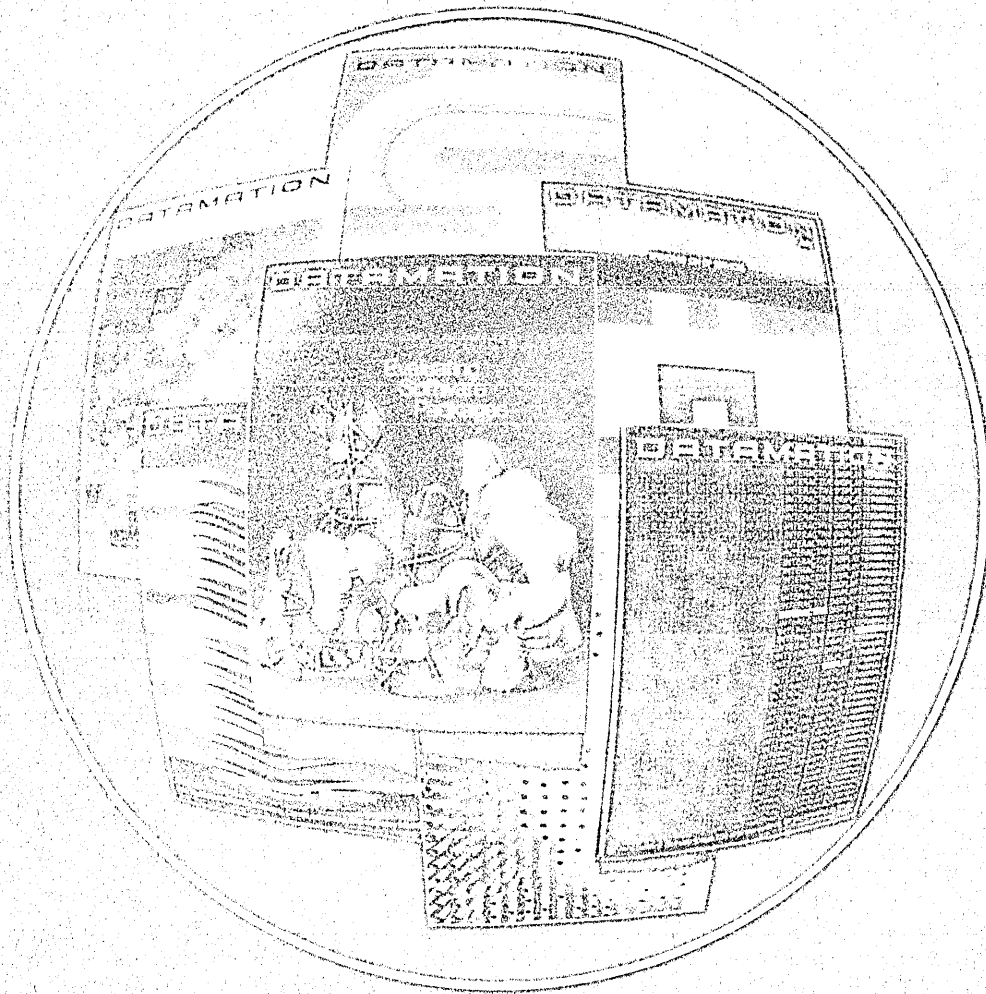

... sells more books in the leisure field than the combined sales of the top five books on the New York Times' best-seller list?

... informs over 1,500,000 readers every month of the latest news, trends, and developments in multi-billion dollar business markets?

... helps to train maintenance craftsmen in some 35 countries around the world at one-third the cost of traditional methods?

These are just a few of the facts about Technical Publishing Company.

Our Company "operates" through DEI Books, Inc. (formerly Diesel Books, Inc.). More than 60 titles serve the growing consumer leisure market in the areas of sports, hobbies, crafts, and nostalgia. Sales last year totaled nearly 2,000,000 books.

Technical Publishing Company "owns" with seven business professional magazines serving specialized markets—Construction, Engineering, Datamation, Plant Engineering, Pollution Engineering, Power Engineering, Purchasing World, Research Development, even is an authoritative leader in its field, serving a list of subjects for business information to help over 1,500,000 readers in their jobs.

We "team" with TPC Training Systems. These proven, self-instructional courses are in use throughout the World, helping to develop skilled maintenance craftsmen. They are used in more than 12,000 manufacturing plants, hospitals, utilities, institutions, government facilities plus over 200 vocational and technical schools.

Technical Publishing Company is publicly owned and our stock is traded over-the-counter. In 1975, our sales were up 23% with a return on equity of 25%, one of the highest in our industry.

For information or a copy of our prospectus, or the company, write to James E. Taffel, President and Chief Executive Officer.



Technical Publishing Company
1601 South Grove Avenue
Barrington, Illinois 60010

OBM

Considering OCR?

Compare and Decide

	IBM 3886	OBM Laser OCR-ONE
Reading Speed . . . 29 full lines/page	Approx. 300/hr.	More than 450/hr.
Maximum Lines per Inch of OCR-A	3	6
Special Timing Marks on Each Form	Required	Not Required
On-Line Correction	Extra Cost Option	Standard Feature
Programming Required	Specialized	Lead Sheet
Environment	Computer Room	Ordinary Office
Cost . . . 2 year rental with maintenance*	Approx. \$4,000/mo.	\$2450/ mo.

*Based on off-line model with industry compatible 9 channel single density tape drive. Includes recognition of alphanumeric OCR-A and numeric hand-print. Also, with on-line correction, line marker and serial numbering.

Compare the performance, accuracy and economy of the Laser OCR-ONE with systems costing many thousands of dollars more. We believe you'll be convinced!

This unique system sets a new standard of excellence for optical character recognition. Simply programmed, easily operated and highly flexible, the Laser OCR-ONE is designed for today's cost conscious market.

We'd welcome the opportunity to give you a demonstration and provide detailed information on the remarkable advantages of the Laser OCR-ONE. Contact me today for complete cost-saving information.

Billy Graham
Vice President/Marketing

Optical Business Machines
900 East New Haven Avenue
Melbourne, FL 32901
305/727-1774

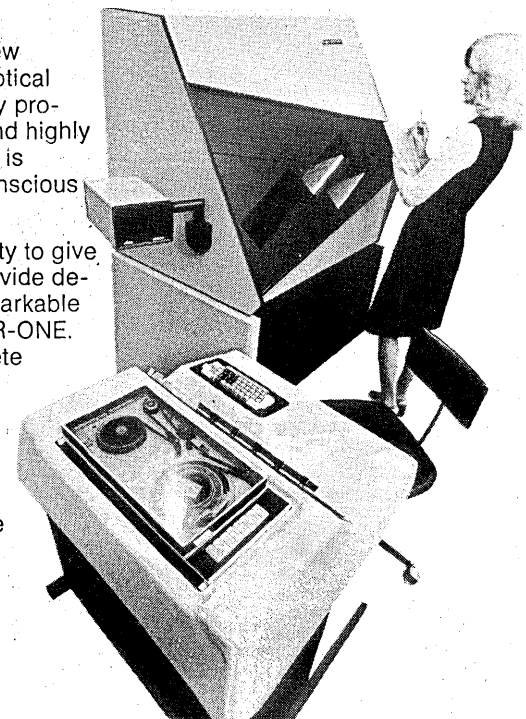

WE MAKE THESE ELECTROSTATIC PRINTER/PLOTTERS EASIER TO READ.

Test it yourself with a free sample roll.

Graphic Controls electrostatic paper reads easier than conventional types. Because it's obviously whiter...giving a sharper, blacker look to letters, numbers, dots and lines.

We should be able to produce a better paper. Making specialty papers is our ONLY business. We produce both report and translucent grades that fit all Gould, Varian and Versatec electrostatic printer/plotters in both roll and fanfold form.

In the wider roll sizes we offer the unique feature of rolls

cross-perforated every 11 inches for easy fanfold stacking.

As a standard feature, we sequentially page number all of our fanfold packs for increased operating efficiency and ease of information retrieval. For your specialized applications, roll and fanfold paper is available with preprinted formats in your choice of color.

All this and...priced significantly below your present supplier.

For more information—or a free sample to make your own reading test—use the coupon. Or call Ray Newstead, Manager of Marketing. Phone: (716) 853-7500, Ext. 352.



Gould

Versatec

Varian

Send me more information on your electrostatic paper, including prices. Estimated annual usage: _____ rolls.

I'd like a free sample to make my own reading test on my _____ machine. Chart No. _____.

Have your representative call. D-9-76

Name _____

Company _____

Address _____

City _____ State _____ Zip _____



COATED PRODUCTS DIVISION
GRAPHIC CONTROLS CORPORATION
189 VAN RENSSELAER STREET, BUFFALO, NEW YORK 14210

Introducing soft hardware.

We call it firmware. Here's how it works:

Design your own computer.

With firmware, we can tailor our computer to your application. It's like starting from scratch and designing your own computer for your particular needs. It's more efficient than software adaptations because firmware is five to ten times faster than equivalent software.

Your software will run only on your computer.

Firmware is like hardware. It becomes part of your computer. It makes your computer different from every other computer. That means the software you write will run only on your computer. It's absolute protection for proprietary software.

If you've already got software, we'll build our computer around it.

Firmware allows a Microdata minicomputer to emulate any computer ever made. If you've already spent a bundle on software, you can protect that investment. And by putting your most frequently used software routines in firmware, you can take advantage of the considerable increase in power

and speed you get with Microdata minicomputers.

Firmware grows right along with you.

Firmware gives you all the advantages of hardware and all the flexibility of software. You can add firmware any time your application becomes more demanding. And you can change it completely without buying new hardware.

Some people call it microprogramming and all our computers have it.

You may already know that we've been talking about microprogramming. State-of-the-art microprogramming is what makes our MicroOne microcomputer and our 1600 and 3200 series minicomputers the most sophisticated and the most powerful computers for any application. It also makes them the most economical.

There's more.

Write us on your letterhead for the whole story on our microprogrammable minicomputers. Now that you know about soft hardware, you can work your software harder.

Write to Microdata Corporation, P.O. Box 19501, Irvine, CA 92713.

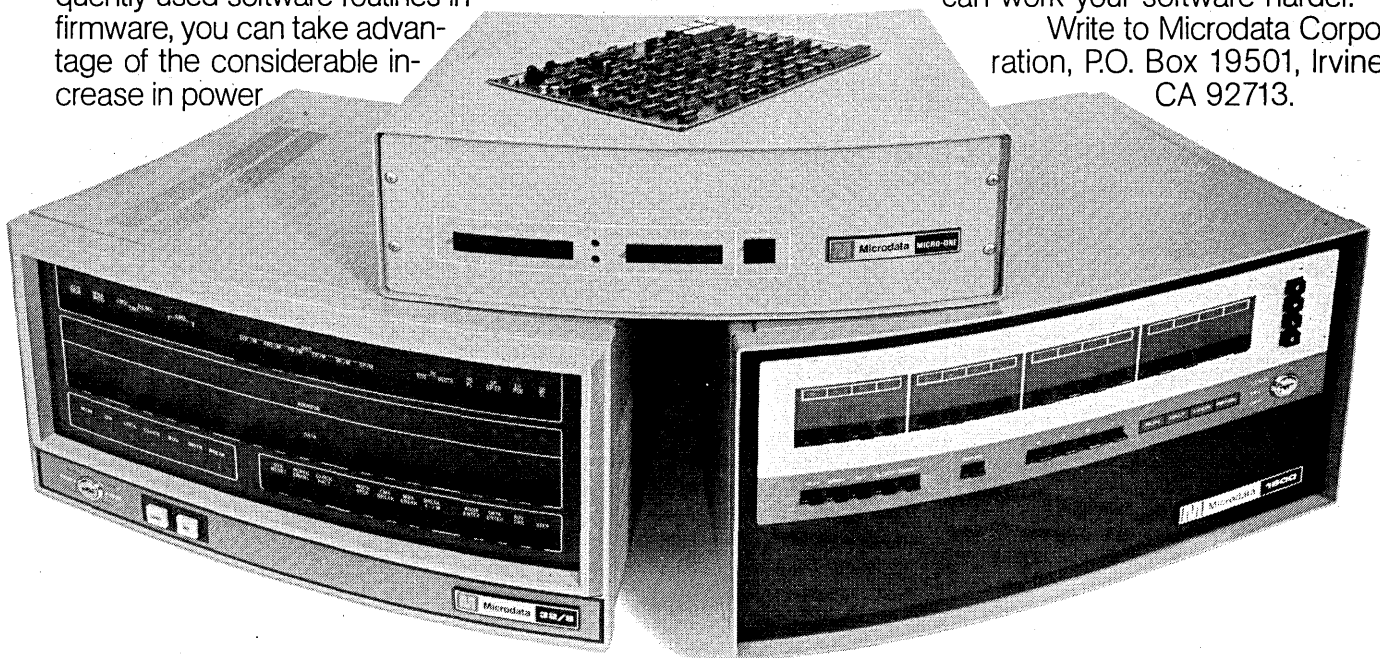

Microdata

17481 Red Hill Avenue, Irvine, CA 92714. (714) 540-6730. TWX: 910-595-1764.
Regional Sales Offices: Western, 714/533-8035; Central, 312/671-5212; Eastern, 201/224-9550; Southern, 813/870-3253

Circle for Immediate Need 36 and for Information Only 37 on Reader Card.

hardware

Off-line

The stunning success of the Viking I Mars landing has prompted many suppliers to claim partial credit for its success, and justifiably so. Some are in our industry: Dicomed Corp., the Minneapolis manufacturer of high resolution special purpose crt displays, also makes image recorders which take the first, unprocessed images from the Viking cameras and hold them for subsequent data processing; Amcomp Inc., Sunnyvale, Calif., is the primary supplier of six disc magnetic recorders that supply and process the monochrome and color images of the Martian surface.

The term "links" when applied to golf has traditionally signified a course situated along the ocean, but the definition may be changing in the computer age. In an effort to improve spectator information on activity at this year's British Open Golf Championship, held at the Royal Birkdale Golf Club in Southport, England, July 5-10, "links" were set up between a Univac DCT-500 terminal in the central score control room and two others in the press tent. Scores telephoned to the score room were keyed in and automatically relayed to other terminals for printing and posting on the scoreboards.

Triformation Systems, Inc., Stuart, Florida, has developed a portable interactive strip embosser, a Braille device for producing Braille in strip paper tape form on tty and tty-compatible terminals.

Don't throw away those crashed or used up IBM 2314 or 3330 (or compatible equivalent) disc heads before checking with Trans-Data Corp. in Belmont, Calif., first. The vendor is in the replacement head business (head hunter?) and is always on the lookout for sources of used heads.

Bradford J. Miller, assistant v.p. at Chicago's Harris Bank estimates that the 3M Computer Output Microfilm system the bank uses has eliminated the need to print nearly 21 million 11x14 pages of paper printout, or enough to make a stack six times as tall as the Sears Tower, the world's tallest building. Computer reports are now made into microfilm and eventually into microfiche at a considerable savings over paper, states Mr. Miller.

Graphics Terminal

The Megraphic 6014 resembles a number of other good quality low-cost graphics terminals introduced within the last year (some by new companies), but has one overriding feature that at the very least makes it controversial: the developers from the start have designed it to be compatible with the estimated ten thousand plus Tektronix 4010-4014 series terminals that have been received so well during the last half decade. Compatibility means cooperating with the same PLOT-10 software package that resides in the host cpu servicing Tektronix units. Another major difference between the 6014 and Tektronix' competitive offerings is that the 6014 features full-screen refresh and is being billed as a

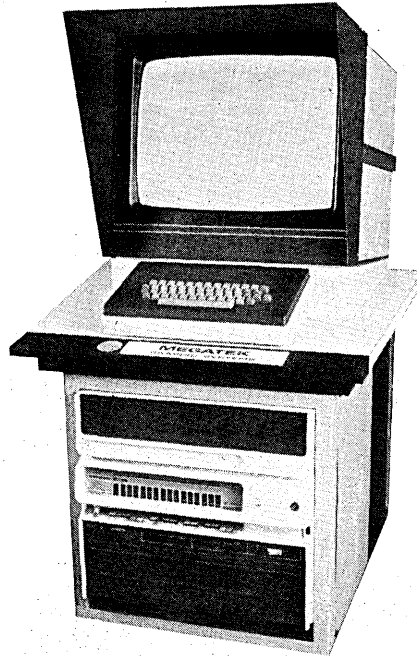

"refreshing alternative" to non-storage tube graphics. Also, the developers feel that the Tektronix users might be eyeing Tektronix' new full-blown graphics system, and the 6014 might satisfy them instead for about half the price.

The basic system consists of a graphics processor for handling relative vectors and jump subroutines, complete with keyboard interface; a 17-inch diagonal crt; a Data General Nova 3/4 processor with 8K words of 700 nsec MOS memory; table/equipment rack; operating system; ASCII keyboard and RS-232 interface for \$15,950. Options include larger CRTs (19- and 21-inch), more memory in the Nova (core or MOS), a larger work desk instead of a table, real-time clock, and dual floppy disc peripheral. Hard-

copy interfaces to a number of electrostatic plotters are also available. The resolution of the screens is 1K x 1K 10-bit points, the vector generator speed is 5.6 usec across the screen diagonal, and there are a total of 16 intensity levels. Deliveries are scheduled for before the end of the year. MEGATEK CORP., San Diego, Calif.

FOR DATA CIRCLE 211 ON READER CARD

Doctor's Office DP

This relatively new firm is taking an interesting approach in the data processing market, tackling the private practice doctor market with, if you'll pardon the pun, "cradle to grave" service. Key to the marketing effort is the willingness of the company to customize the software so that office personnel will be seeing the same familiar forms they have been using all along, only generated by the system. An Interdata 616 with 64K words of memory is the computing engine, and the mainframe can support up to 50 terminals in a polling configuration, tape drives, from 5-200 megabytes of disc storage, and a 110 cps bidirectional printer. Not only is the system being offered nationwide, but the vendor is making arrangements on an international scale, first in Europe.

The software consists of the operating system and basic accounting packages which are altered to accommodate each customer's procedures. Medical records, billing, accounts payable, taxes, payroll, insurance forms, and government reports are all maintained by the system. System prices begin at approximately \$21K. MED-E-COMP CORP., Hurst, Texas.

FOR DATA CIRCLE 212 ON READER CARD

Interconnection Unit

The developers of the "3R" system hope it will become as basic to the data processing industry as the scholastic Three Rs—and that just might happen. The 3R makes it possible to connect two or three different manufacturers'

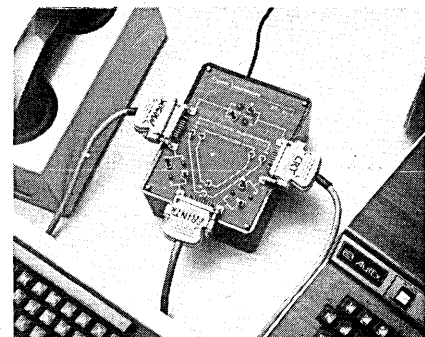

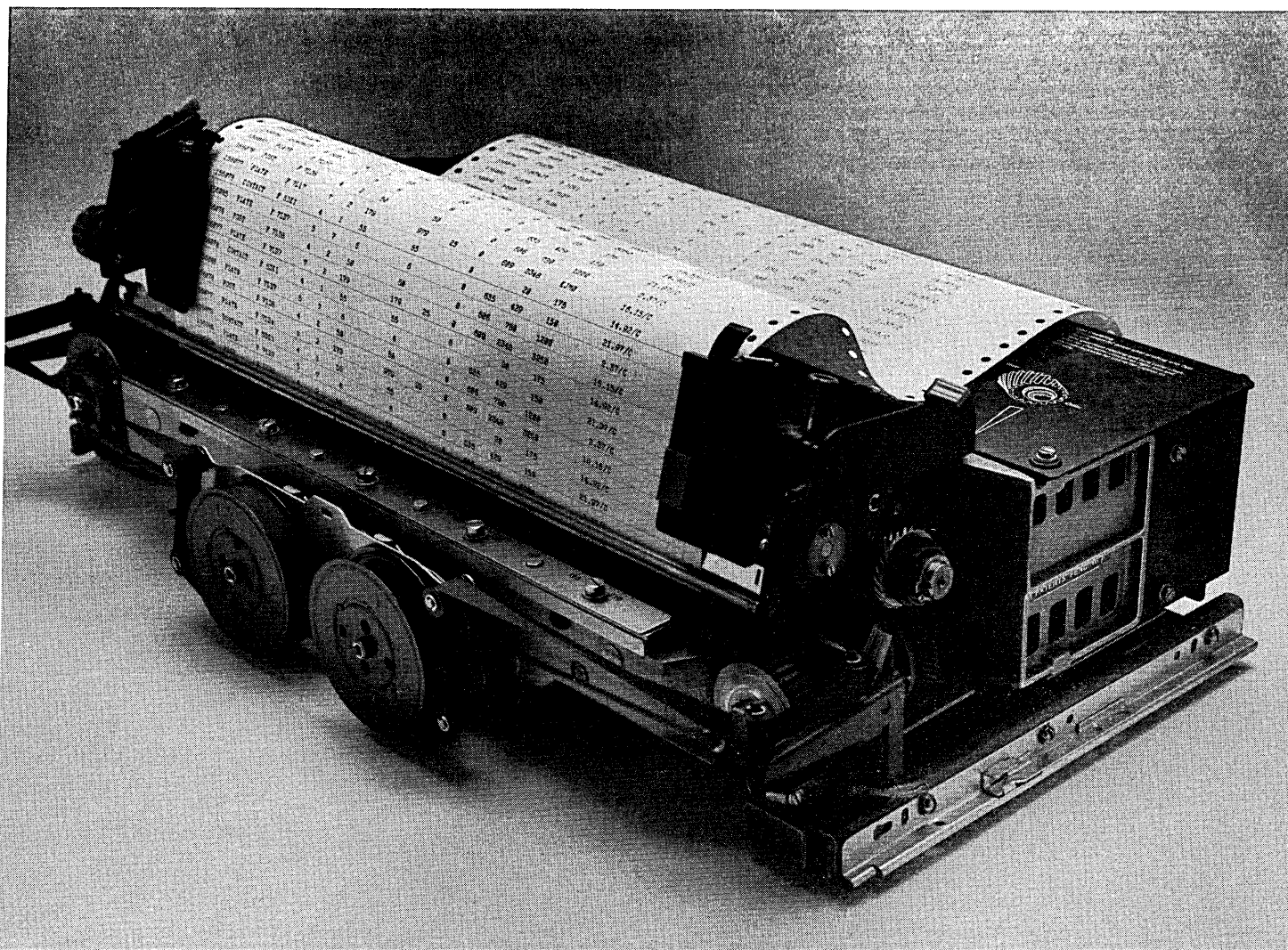

132 columns. Over 300 lines per minute. Under \$2000*.

In printers, it's not just a question of how much they cost, but one of how much you get for your money. And on a price/performance basis, nothing even comes close to the Teletype® model 40 OEM printer.

Besides getting a 132-column, heavy-duty impact printer that delivers over 300 lpm for less than \$2000, you also get a printer with outstanding flexibility and reliability.

The big reason behind the model 40's price/performance advantage over the competition is our unique design. Even though it operates at speeds over 300 lpm, wear and tear is less than you'd find in a conventional printer operating at a much slower speed. Fewer moving parts and solid-state components add up to increased reliability and reduced maintenance.

We'd be ahead if we just stopped there, but the model 40 also offers you a number of other features. Like a choice of character sets, operator-adjustable form width and form length, parity error indication, and a built-in self-test feature, just to name a few.

For complete information, please contact our Sales Headquarters at: 5555 Touhy Ave., Skokie, Ill. 60076. Or call Terminal Central at: (312) 982-2000.



**The Teletype model 40 OEM printer.
Nothing even comes close.**

Miniterm[®] 1203.

New Portable Champ With The Knockout Features.

The new Miniterm 1203 from CDI packs a fistful of powerful features into an easy handling, lightweight package that makes it a winner for every timesharing application.

Ideal for programmers, salesmen in the field, or anyone who wants to have computing power at his fingertips, the Miniterm 1203 interfaces with all popular timesharing systems and can be used just about anywhere. All you need is an ordinary wall outlet and standard telephone, and you're on-line.

The Miniterm 1203 is at home in any environment. Quiet and unobtrusive, it doesn't need much desk space and is built tough to take the punishment of daily use. In fact, it is the only portable terminal warranted for a full year.

All the Miniterm 1203 features have been designed with the user foremost in mind. For example, the unique 3-way mode keyboard has TTY, upper/lower case typewriter, or numeric only, selectable by the operator!

Everything about the Miniterm displays the kind of engineering excellence users have come to expect from CDI.

Go with CDI's Miniterm 1203. The portable terminal winner.

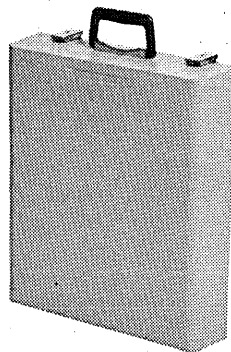
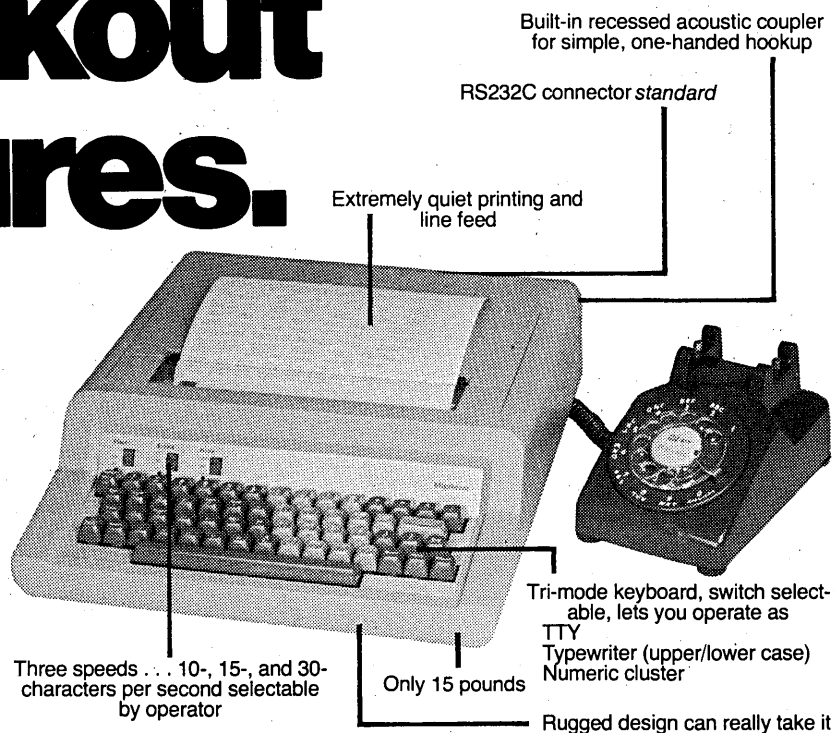

**COMPUTER
DEVICES INC.**

9 Ray Avenue
Burlington, MA 01803
(617)273-1550

Go With The Guaranteed* Winner!

*one year warranty

Electrostatic plotters have always been faster than pen plotters—often hundreds of times faster. They can draw square feet of data while a pen plotter is writing its first thin lines. And because they use the electrostatic writing technique, high data density and plot complexity don't reduce speed.

With the new on-line Versatec 360/370 plotting system you can draw business graphs, production patterns and PERT charts. Or engineering drawings. Or contour maps. Or plot scientific data. In fact, you can draw just about anything, and do it faster, more reliably and at lower cost than with mechanical plotters.

The Versatec 360/370 plotting system operates without modification to IBM hardware, operating system or existing graphics programs. It uses standard IBM system and spool writers. Accepting data on the channel interface in burst,

forced burst or byte multiplex mode, the system's double buffer accepts a maximum burst rate of 500,000 bytes per second.

The Versatec 360/370 plotting system can accept vectored pen plotter graphic information and automatically convert it to raster data for electrostatic plotting. This reduces host computer time, core memory requirements and I/O channel time. Overall plot processing efficiency is the highest available.

Versatec supplies everything—new on-line system controller that can accommodate up to four plotters, new plotting software that includes emulation of existing pen plotter programs, and wide selection of electrostatic plotters in widths from eight and one-half to 72 inches.

For more information, fill out the coupon for your copy of a new sixteen page brochure "The 360/370 Plotting System."

VERSATEC
2805 Bowers Avenue
Santa Clara, California 95051
Telephone: (408) 988-2800

name _____

department _____

telephone _____

organization _____

address _____

city, state and zip _____

Computer model and operating system _____

 **VERSATEC**
A XEROX COMPANY
CIRCLE 19 ON READER CARD

Now my 360/370 can plot thirty square feet per minute!

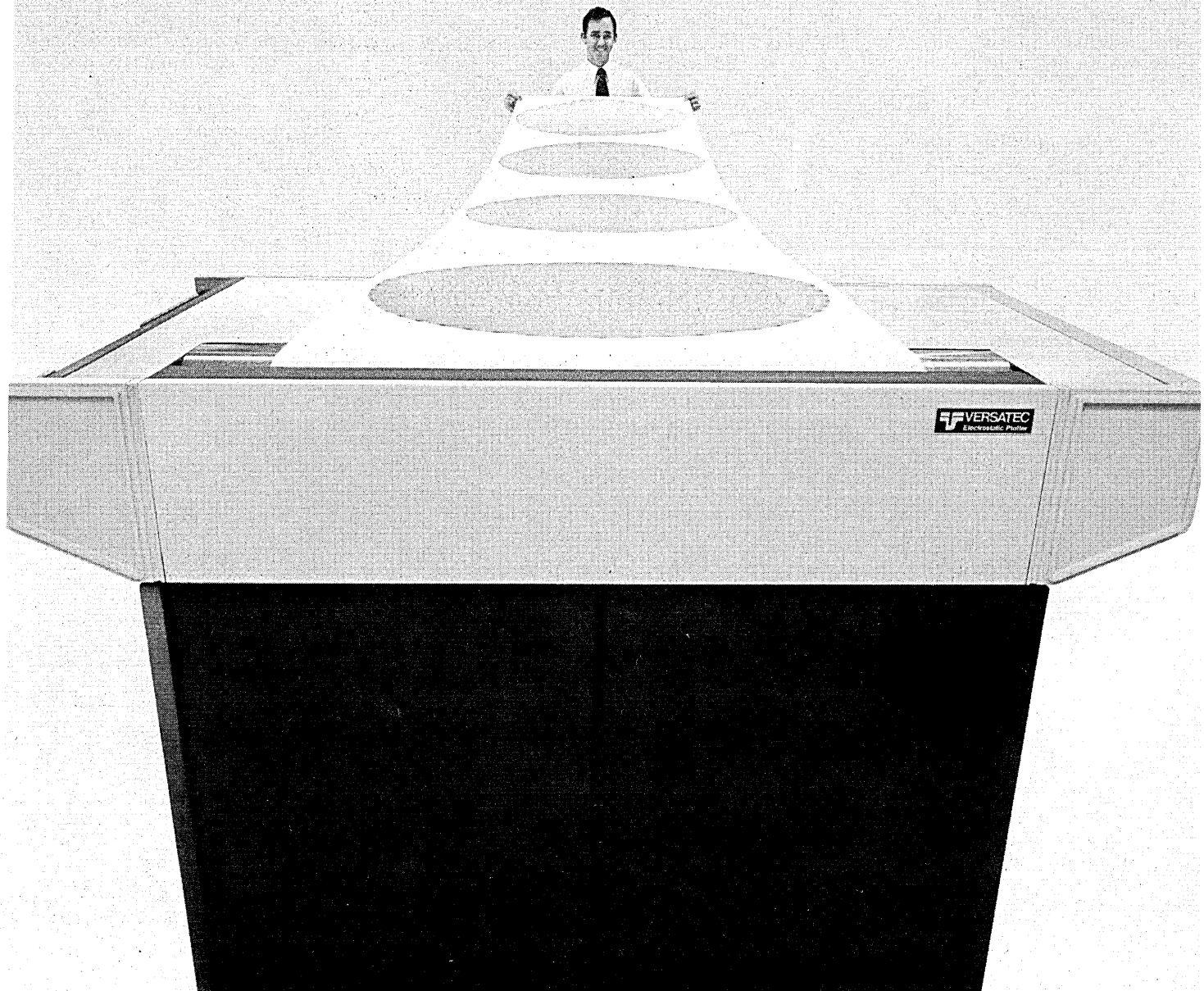

hardware

RS-232C devices, such as ttys, modems, terminals, displays, or computers into a common system. A typical application would be adding a cassette unit to operate in parallel with a video display/keyboard already connected to a modem or a computer. Each of the three ports on the 3R have associated switches that interchange transmit-and-receive signals and can be set up in either the voltage (RS-232C) or current loop (20 ma) mode. Six more switches establish any combination of the 63 possible communication connections between three i/o devices, and each data path has an associated LED monitor. The unit is priced at \$350. DIGITAL LABORATORIES, Watertown, Mass.

FOR DATA CIRCLE 213 ON READER CARD

Flexible Disc Terminal

The Floppy Disc Send/Receive (FDSR) terminal comprises a floppy disc with more than 311K characters of storage, RS-232 interface compatibility, and data/search capability. Thus, the device should compete favorably with cassette-oriented terminals in applications more suited to the random access virtues of the floppy disc. More than



2,400 addressable lines of 128 characters each can be accessed from the FDSR or any asynchronous crt or keyboard/printer terminal for storage/editing purposes. Prices begin at \$1,995. RANDAL DATA SYSTEMS INC., Torrance, Calif.

FOR DATA CIRCLE 214 ON READER CARD

PDP-11 Communication

The LLA 400 is a combination of software and hardware support for high-speed communication for DEC PDP-11 minis running the DEC RT11 or COMTEX operating systems. The long line adapter, as it's called, enables 277,000 cps communication at distances up to 1.5 miles using only a single coax cable. The software support and DMA hardware allow networks of computers using FORTRAN or assembler language to communicate at high data rates for a relatively low price. Two of the LLA 400s can be purchased

for \$9K. SYSTEM ASSOCIATES, INC., Troy, Mich.

FOR DATA CIRCLE 215 ON READER CARD

Data Collection

Even the clipboard has gone intelligent! The DATAMYTE replaces the standard clipboard/stopwatch method of data collection. Instead, entries are made on a numeric pad attached to a 16K memory bank. Time recordings

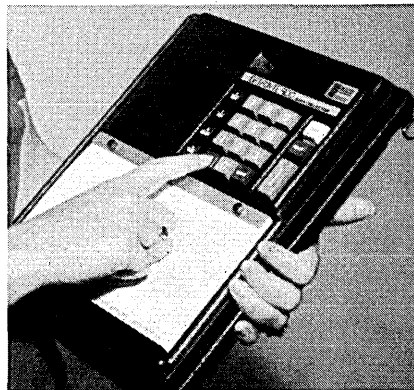

are automatic, with an interval timer adjustable from .5 to 32 minutes. Add-on memory packs of 4K allow a range of positions up to 32K. To retrieve information from the DATAMYTE, one merely plugs it into the RS-232 connector found on most terminals. Direct readout for processing can then commence. The output rate is selectable from 110-4800 baud. Output cables for Texas Instruments and Teletype

Corp. products are also available. Prices start at \$2,490; 4K memory additions run \$150; hip pack battery case \$129; power/charger unit \$139, etc. ELECTRO/GENERAL CORP., Minnetonka, Minn.

FOR DATA CIRCLE 216 ON READER CARD

Intelligent CRT

At first glance, the 8030 display terminal looks a lot like most other microprocessor-equipped terminals introduced during the last several years, but this one has some unique features. First, the user can program communications functions directly from the terminal keyboard. Communications speed, parity, bits per word, and stop/start bits are all programmable, as is an end-of-block terminating character. This obviously qualifies the 8030 to communicate with various manufacturers' communication protocols.

Two pages of memory are refreshed on the 8030, a total of 3840 characters. This makes it easier to scroll through both pages. For applications employing the "protected field" mode the terminal offers three more features: literals transmission, a capability that permits identification of the beginning and end of data fields by transmission of control characters imbedded in the protected field; trailing space suppress, that eliminates transmission of blank spaces in completed forms; and numeric field definition,

product spotlight

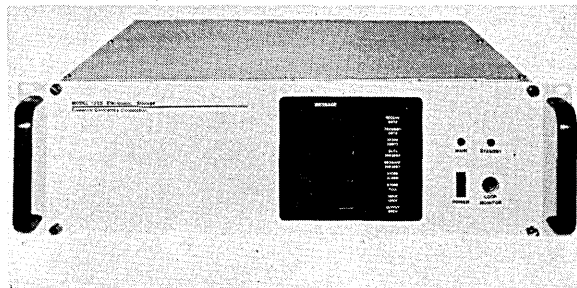

Communications Buffer

The model 1355 data communications buffer is going to make it easier for a lot of people to implement data communications networks now on the drawing boards. Comprised of a number of charge-coupled-device (CCD) semiconductor circuits, the 1355 can be set up to perform the following operations: message accumulation at asynchronous rates with retransmission at higher synchronous rates; automatic forwarding of data in response to polling signals; automatic message counting; and retransmission of previously handled data. A microprocessor option enables the 1355 to do "on the fly" code conversion, changing 5-, 6-, 7-, or 8-level character codes into whatever code is desired. Different operating speeds, code format differences, transmission modes (serial

versus parallel), and intermixed synchronous versus asynchronous links are no longer a problem and don't require a full-fledged minicomputer to resolve them. Switches on the back of the 1355 set up the specific task it is to do. (Obviously some users would like to have this capability as a programming feature, which might just be a follow-on development.) I/O circuits for serial data can be: polar or neutral telegraph current loops; EIA-RS-232, MIL-STD-170, or CCITT V-24; and V-28 type low-level compatible circuits. Output is obtained either character by character or by full message. The basic price of a 32K box (expandable to 256K) is \$2,950. The code conversion capability adds \$1K to that price. Deliveries are under way. FREDERICK ELECTRONICS, Frederick, Md.

FOR DATA CIRCLE 210 ON READER CARD

Solutions to some of the world's toughest communication requirements started with one simple message.

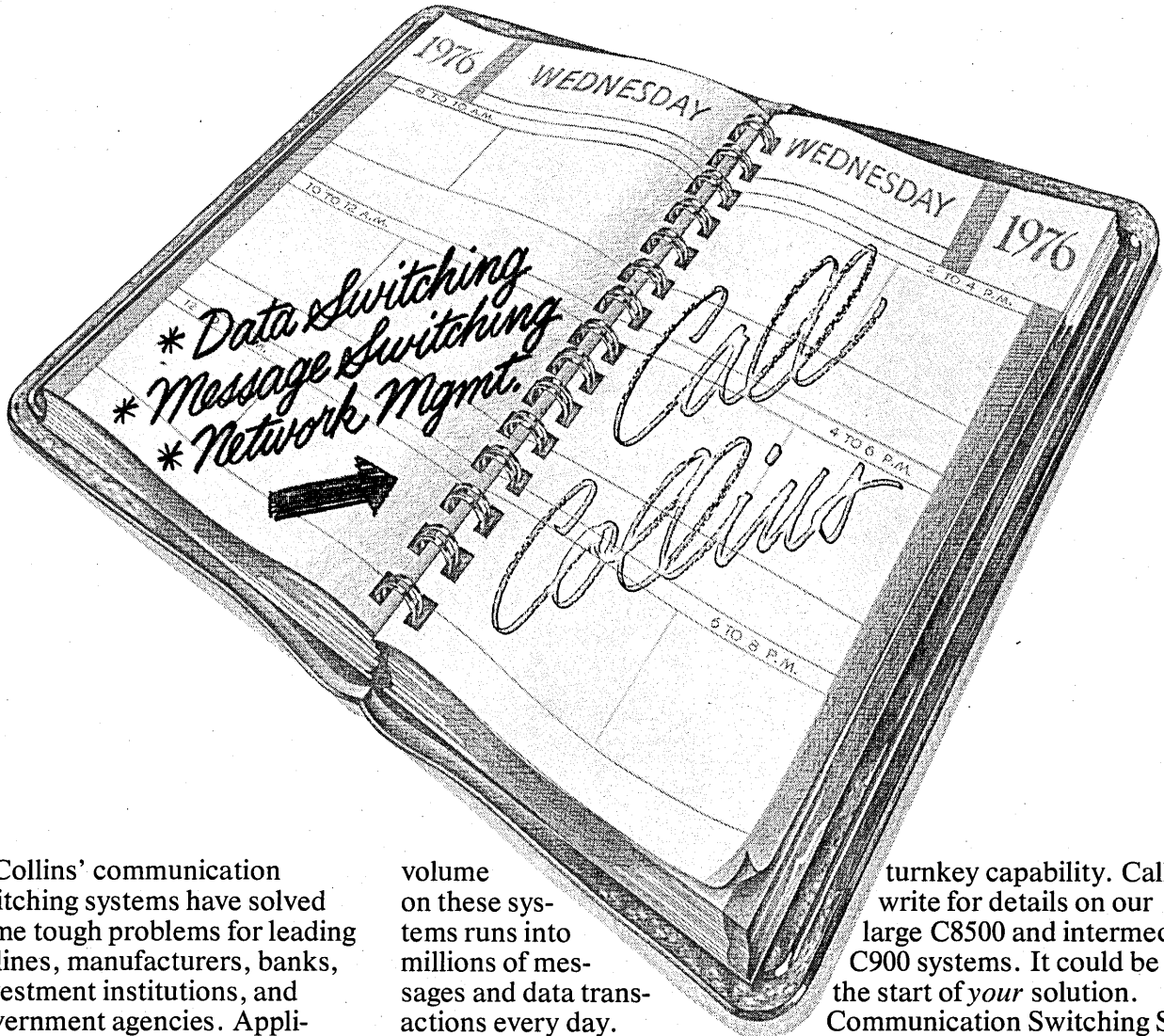

Collins' communication switching systems have solved some tough problems for leading airlines, manufacturers, banks, investment institutions, and government agencies. Applications that demand high speeds and capacities, utmost reliability, and the know-how to make it all work. The total traffic

volume on these systems runs into millions of messages and data transactions every day.

If your business depends on extensive message and data communications over a distributed network, we have the experience to help you. Plus total

turnkey capability. Call or write for details on our large C8500 and intermediate C900 systems. It could be the start of *your* solution. Communication Switching Systems Marketing, Collins Radio Group, Rockwell International. Contact us in one of the cities listed.



Rockwell International

Dallas
214/690-5000

New York
212/661-6530

London
01-759-9911

Paris
686-10-03

Frankfurt
(0) 6106-4093

Rome
851-104

THE TRUE VALUE OF YOUR 360 CPU IS ITS MEMORY!

For example . . . today's cost for an IBM 360 is about 25% of the current price for an add-on Memory. This does not mean that you should put your 360 out to pasture. Far from it. Your 360 is a very enhanceable CPU and Standard Memories has a better idea . . . SMART® Systems. The simple addition of the Standard SMART® compatible Core Memory can give your basic 360, regardless of Model, an entire new generation of life expectancy.

SMART® Systems is total assurance of reliability, low-cost, minimal downtime, and huge increases in computer memory within a small space. The SMART® Systems Series are a unique memory attachment that offers the user complete flexibility of configuration. You

can replace your present 360 core memory or expand its capacity to as much as 2.0 Meg-A-Bytes with a Standard Memories' SMART® System. You can actually more than double the capacity offered by IBM.

MODEL SM 300

IBM 360/30 Compatible Memory up to 512K Bytes

MODEL SM 400

IBM 360/40 Compatible Memory up to 512K Bytes

MODEL SM 440

IBM 360/44 Compatible Memory up to 1.0 Meg-A-Bytes

MODEL SM 500

IBM 360/50 Compatible Memory up to 2.0 Meg-A-Bytes

Call or write Herb Godfrey

STANDARD MEMORIES  **AN APPLIED MAGNETICS COMPANY**

4120 Birch St., Suite 105, Newport Beach, CA 92660 (714) 752-8455 TWX 910-595-2533

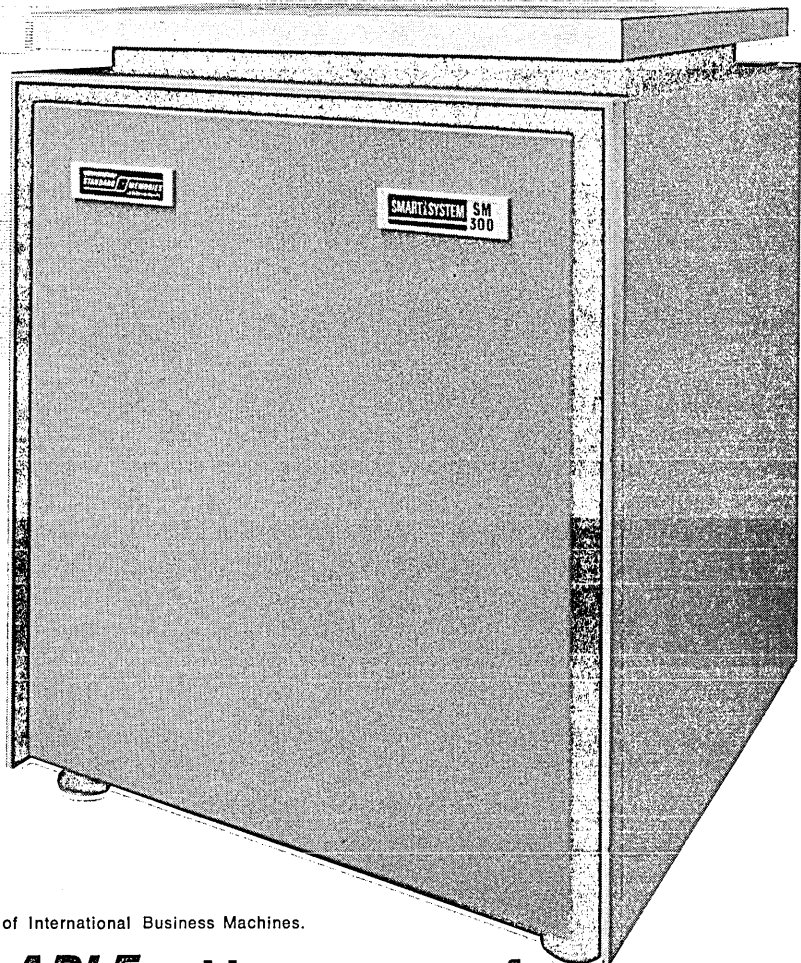

IBM and their Model designations are registered trademarks of International Business Machines.

**ALSO AVAILABLE: add-on memory for
IBM 360/20 and SYSTEM/3 Model 10 & 15.**

CIRCLE 90 ON READER CARD

hardware

that prevents entering of all but numeric characters in certain fields, thereby partially pre-editing data.

The hardware specs include a 15-inch diagonal, 1920-character display using 7 x 9 dot-matrix characters with

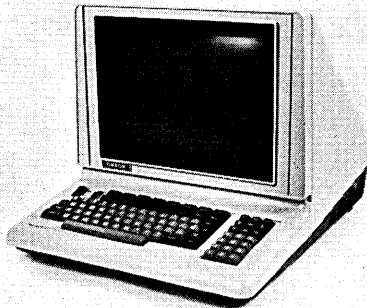

a half-dot shift feature that yields an "effective" 14 x 9 dot matrix for better legibility. The price for the 8030 is \$2,750. OMRON CORP. OF AMERICA, Sunnyvale, Calif.

FOR DATA CIRCLE 217 ON READER CARD

Media Transportation

You certainly wouldn't want to risk damaging IBM (or equivalent) 3348 data modules when transporting them to other processing sites or to storage

vaults. Not only do the modules cost upwards of \$2K, they hold as much as 70 megabytes of your company's information on them. For that reason this manufacturer has introduced the model 5142 data module case. It's made of aluminum with a tubular handle and two locking draw bolts. The case is lined with form fitting shock absorbing polyester foam and is priced at \$85. ALUMINUM CASE CORP., Chicago, Ill.

FOR DATA CIRCLE 218 ON READER CARD

Computer Training

The Com-Tran Ten might just be one of the most sophisticated computer training devices ever built. For starters, there's 1K bytes of memory, expandable to 2K and even 4K. That allows operations to actually be performed instead of simulated, and there's simultaneous display of all register contents. A four-position mode-control switch can be used to slow the system down so that the student can see register contents change, or watch the cpu call for a memory address or instruction, etc. In the five manuals that accompany the system is a pre-programmed teacher instruction manual to help students learn through intuitive thinking. Also explained are concepts such as counting, shifting, decoding, timing, control, memory organization, and arithmetic techniques. Circuit princi-

ples are learned from the basic logic. Prices begin at \$7,500. DIGIAC CORP.,

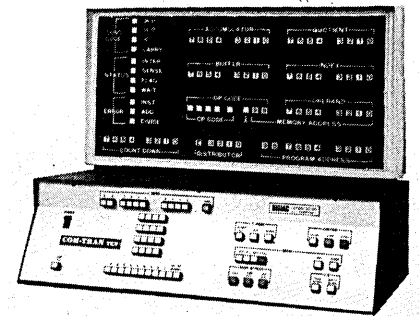

Smithtown, N.Y.

FOR DATA CIRCLE 219 ON READER CARD

Hybrid Computer

One of the few segments of the industry that hasn't been able to benefit from the dramatic reductions in the price of integrated circuits has been the analog and hybrid computer community, since these machines are largely constructed of discrete components. This manufacturer has found a way to whittle the price down to under \$35K, however, and that's for a reasonably capable system.

The MiniHYBRID consists of a 16K DataPACER digital processor, and a model 185 parallel analog processor complete with communications interface for 60 analog/digital channels and an ASR-33 tty for digital I/O. Ap-

PENRIL SHORT HAULS FOR THE LONG HAUL

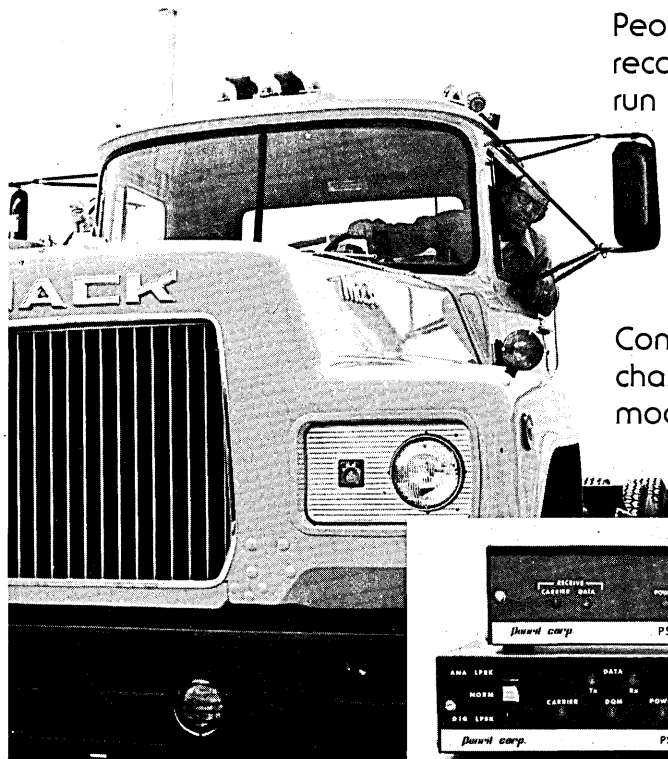

People who use Penril Short Haul data modems recover their investment in short order. In the short run as well as the long haul, Penril's economical and reliable Short Hauls provide large dollar savings. Whether you are a trucking company or a manufacturing company, Penril Short Haul modems are your best buy...10-4?

Contact us for information concerning significant changes recently incorporated into our Short Haul modem series to enhance their capability.

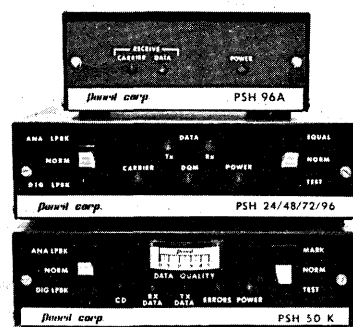

Penril Corp. Data Communications Division

5520 RANDOLPH RD., ROCKVILLE, MARYLAND 20852
(301) 881-8151 • TWX 710-828-0522

The Summit, 2 Castle Hill Terrace, Maidenhead, Berkshire, England SL6 4SP
Maidenhead (0628) 21217, TELEX 849131

CIRCLE 139 ON READER CARD

hardware

pendent to the mini is 133K words of floppy disc storage, and the system can be expanded to include an alphanumeric/graphics crt, x-y plotter and additional digital/analog interface capability. Optional peripherals include

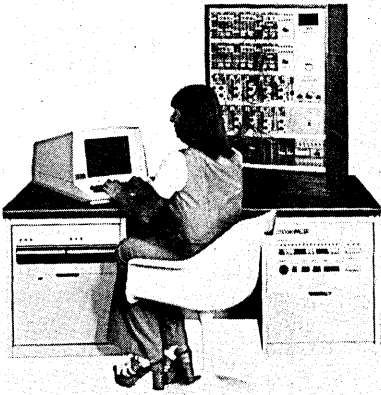

a 300 cpm reader and a 165 cps line printer. Contained in the analog processor are integrator/summers, summers, coefficient attenuators, multiply/divide circuits, track/store, and comparators. The usual patch panel is included for patching digital logic. Also featured are four-channel external data acquisition capability, and optional four-channel oscilloscope and

the x-y plotter. The software consists of the operating system, five language processors (including FORTRAN IV), utilities, diagnostics, and program libraries. ELECTRONIC ASSOCIATES, INC., West Long Branch, N.J.
FOR DATA CIRCLE 220 ON READER CARD

Floating Point Circuit

The Model A Floating Point Board is designed for use with Intel 8080 microprocessors, endowing them with arithmetic speeds said to rival most minis. The unit performs add, subtract, multiply, and divide on BCD format floating-point values. The precision of the unit (up to 14 digits) is under program control. The typical add/subtract time is 20 usec, with typical multiply/divide times on the order of 100 usec. Those speeds are roughly 25 to 50 times faster than if the operations were performed in the 8080's software, the developers point out. The pc board is priced at \$499. NORTH STAR COMPUTERS, INC., Berkeley, Calif.
FOR DATA CIRCLE 221 ON READER CARD

Array Processing

Hewlett-Packard 2100 series users can now attach an array processing peripheral capable of performing up to 15 million properly rounded, 32-bit floating-point operations per second. The programmable array processing peripheral, called MAP, doesn't have

truncation, noise, or scaling problems either, we're told. About a day is required to interface the hardware and software.

Among the operations that can be performed are a wide range of algorithms, (FFTs, complex multiply, correlation, convolution, recursive filter, etc.). SNAP II is the software provided with the MAP, featuring one-step pro-

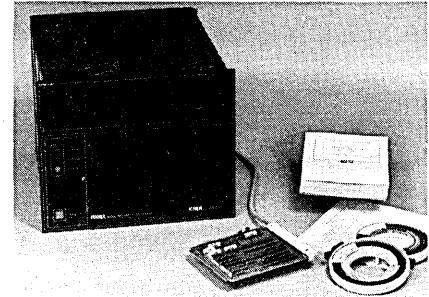

cedures for initiating complex, real-time mathematical operations. Instead of requiring a sequence of steps as is needed with conventional processing units, one FORTRAN command allows the complete operation to be performed. An array of linear and nonlinear array functions as well as data management routines are contained in the program library for the MAP. Prices start at \$8,400 for complete systems. CSP INC., Burlington, Mass.
FOR DATA CIRCLE 222 ON READER CARD

for the equipment that deserves a good home

deskware™

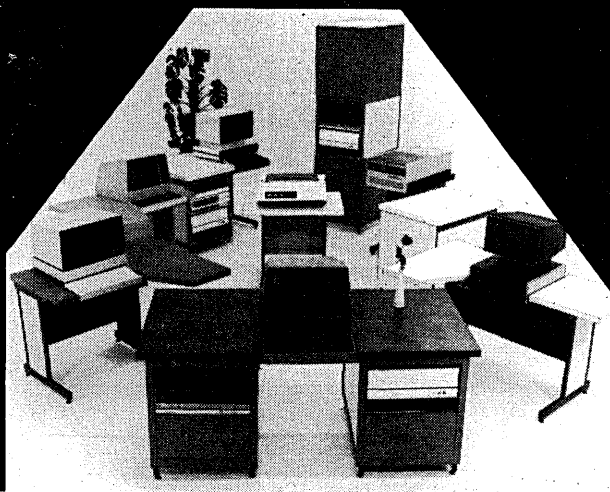

MCS designs
525 Executive Boulevard • Elmsford, N.Y. 10523 • (914) 592-8812

CIRCLE 138 ON READER CARD

CAS III 2A3

NO MATTER HOW YOU LOOK AT IT ...

CAS III

IS THE MOST FLEXIBLE, MOST USER-ORIENTED
FINANCIAL REPORTING SOFTWARE
ON THE MARKET TODAY!

SYSTEM HIGHLIGHTS

- Clerically Driven/User Controlled
- Comprehensive Data Base
- New Concept in Documentation (Interdependent Referencing)
- Multi-Company (Service and Corporate Environments)
- Application Program Changes are Eliminated
- Modular Installation Based Upon Your Requirements
- User Controlled Report Writer
- Multiple Years of History
- Firm and Flexible Budgeting (Department, Cost Center, Account Level)
- High Volume Automatic File Maintenance
- Independent Edit/Validation Function
- Account Analysis to Detailed Transaction Level

COMPUTER REQUIREMENTS

- IBM 360/370, Univac 9400
- Available DOS and OS
- Interface to Any Data Base Manager

WHY NOT?

Let COMSERV take the proper look at your requirements soon.

Call or write -
SANFORD ROSEN
3050 Metro Drive
Minneapolis, Minn. 55420
(612) 854-2020

comserv CORPORATION

CIRCLE 104 ON READER CARD

DATAMATION

Understanding the economic impact of a Kodak COM installation.

The most cost-effective approach to COM is a lot easier to find now because of a Kodak service called PRINTCOM. It lets Kodak actually premeasure the savings you can expect, using your own cost figures, when you put a Kodak KOM-80 microfilmer to work in your EDP environment.

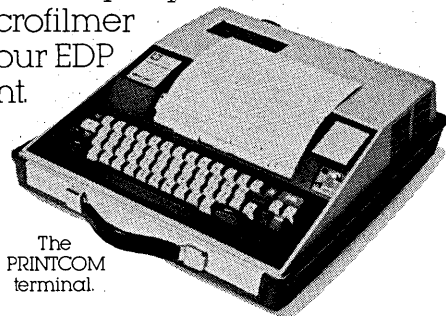

The
PRINTCOM
terminal.

During PRINTCOM analysis, we input as many as 300 of your cost variables into a PRINTCOM terminal and get back a detailed financial analysis of your immediate savings and of your long-term savings potential.

You will find this information invaluable, particularly in light of the emphasis being placed on return on investment.

Beyond PRINTCOM, Kodak is putting a great deal of effort into COM research. Some of this effort and investment has already paid off in technological improvements and versatile software pro-

grams Kodak can provide to its users.

A case in point is our new INFO-LINK I software package. It does away with the need for new application programs each time a microfiche job goes 'live.' It's just one more way Kodak can help you maximize your savings in the EDP environment.

The closer you are to COM, the sooner you should check with us. For an informative view of microfilm and the computer, write today. Eastman Kodak Company, Business Systems Markets Division, Dept. DP 6700, Rochester, N.Y. 14650.

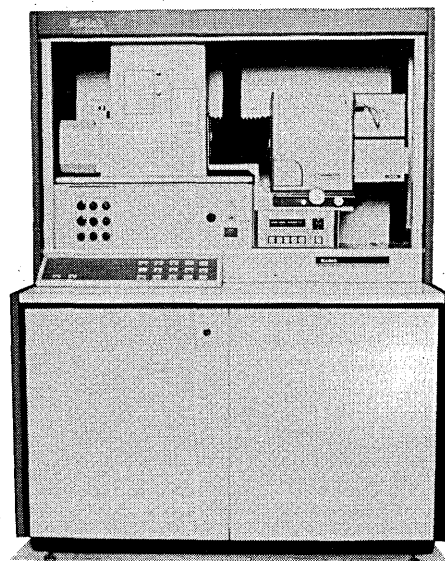

Kodak KOM-80 microfilmer.
For top throughput speed
with high reliability.

hardware

Fast Fourier Transforms

Systems houses assembling products for the vibration test, scientific instrument, bio-medical analysis, speech recognition, voice control, and mechan-

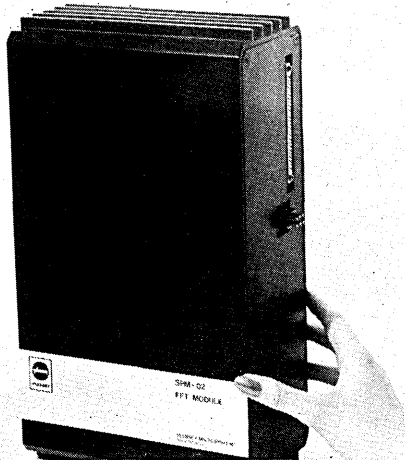

ical test markets are going to need a Fast Fourier Transform processor to use with their minicomputer, and here are two new ones. They are totally self-contained and are based on the 16-bit MIPROC 16 microcomputer. The SPM-01 has a transform characteristic of 1K complex points in 600 msec, while the SPM-02 can reduce the same data in 250 msec. Data input for the two

modules can be in either analog or digital format at speeds up to 50 KHZ, with a user-optional Hanning window as a standard feature. Either forward or inverse FFT are performed, with output transmitted in analog or digital form as either real, imaginary, alternate real and imaginary, or as a computed power spectrum. Prices for the SPM-01 and SPM-02 are \$5K and \$6K respectively. PLESSEY MICROPROCESSOR PRODUCTS, Irvine, Calif.

FOR DATA CIRCLE 224 ON READER CARD

370/168 Add-on Memory

Not only will the price schedule for the 370/STOR 168 add-on memory look attractive to IBM 370 model 168 users, the feature list looks pretty impressive, too. The memory is said to be completely transparent to all IBM hardware and software, including microcode and maintenance diagnostics. Almost as important, the 370/STOR 168 uses N-channel, static memory devices instead of dynamic ones, meaning that the memory doesn't have to be refreshed every 20 usec or so. The result should be better cpu throughput. In addition, the chance for single-bit errors should decrease since the chips aren't continually being refreshed.

A customer panel allows operators to isolate any failing one-megabyte partitions to determine if a failure is in IBM memory or this manufacturer's.

An off-line switch further aids problem detection by allowing all of the vendor-supplied memory to be removed from the system, leaving only IBM-supplied memory functioning. Prices are as much as 40 percent below equivalent IBM prices, it's claimed. CAMBRIDGE MEMORIES, INC., Bedford, Mass.
FOR DATA CIRCLE 223 ON READER CARD

Honeywell Printers

Line printers for all models in Honeywell's 2000 and 6000 series product lines have been announced by this systems house. Four models are included, all featuring a patented print hammer system, 90° swing-open gate for



ribbon and paper loading, accommodation of one- to six-part forms and interchangeable character sets—ASCII, OCR, upper/lower case, and custom sets.

The M-260 operates at 600 lpm

Computers can't read dirt.

Practically all tape and disk errors are caused by self generated contamination. 90% can be eliminated by routine cleaning and testing. It's that simple.

With tape and disk maintenance, backups and retries are avoided, throughput is boosted; the risk of equipment damage is reduced. The cost of computer time for

even a small DP installation can be cut by thousands of dollars each year.

Kybe's cleaners, testers and certifiers pay their own way by keeping disks and tapes at peak operating efficiency. Kybe was the first in tape maintenance and is the world's largest. For details contact:

Kv **KYBE**
KYBE CORPORATION
 132 Calvary Street, Waltham, Mass 02154
 Tel. (617) 899-0012, Telex 94-0179
 Offices & representatives worldwide

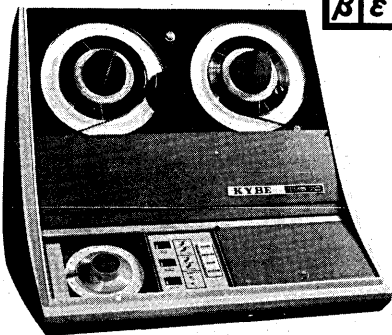

CIRCLE 135 ON READER CARD

Mini-Tech Means TECH CONTROL

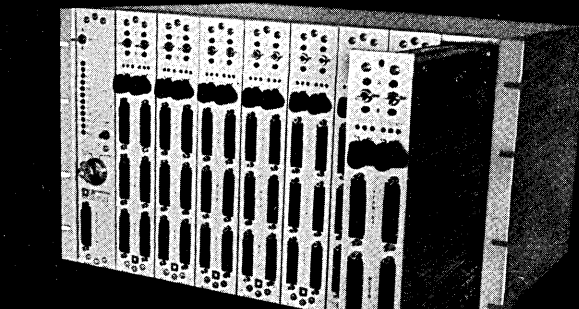
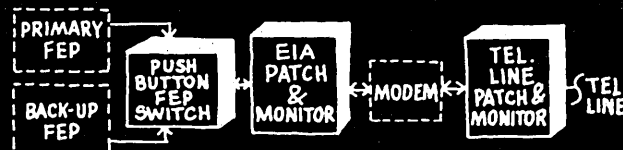

FRONT-END
 PROCESSOR SWITCHING
 & EIA/TEL LINE
 INTERFACE PATCHING
 AND MONITORING

mini
tech
 MODULES

100 Nashua St.
 Prov., R.I. 02904
 Tel. (401) 274-5100
 TWX 710-381-0285

INTERNATIONAL
DATA
SCIENCES, INC.
ADVANCED TECHNIQUES IN DATA COMMUNICATIONS

CIRCLE 133 ON READER CARD

(\$25,940), the M-290 at 900 lpm (\$29,715), the M-550 at 1500 lpm (\$42,500), and the M-470 runs at 1800 lpm (and is priced at \$38,200). Prices include installation anywhere in the U.S. and operator training. Maintenance contracts range between \$200 and \$300/month. Delivery is 90-120 days after order. MACRO PRODUCTS CORP., Long Beach, Calif.

FOR DATA CIRCLE 225 ON READER CARD

Data Entry

The 7218 numeric data entry device is intended for low-cost, numeric only applications, primarily with this manufacturer's NCR 250, 399, 499, and 8200 systems. The 7218 consists of a micro-processor, a numeric key pad and function keyboard, journal tape unit, and Philips-type cassette drive. Data is

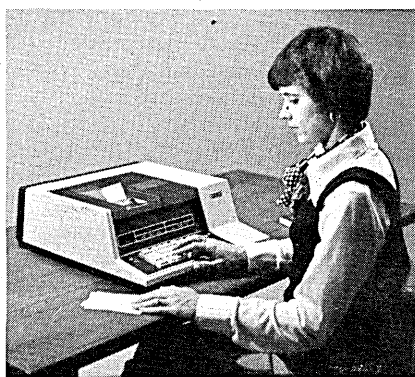

read into the 7218's memory using the magnetic tape cassette. Using the numeric key pad and function keys, the operator then enters data. Each entry is printed on the journal tape, providing an audit trail. Included in the 7218 is a five-function printing calculator with its own auxiliary memory and totaling register. The calculator can be used without affecting the data being recorded on the cassette. Prices begin at \$2,275. NCR CORP., Dayton, Ohio.

FOR DATA CIRCLE 226 ON READER CARD

Matrix Printers

This manufacturer's 5700 series consists of two models, capable of printing 330 and 165 characters per second. The single-head 5701 yields a print rate of 50 lpm across 132 columns, while the 5703, a dual-head model, outputs 75 lpm. The printhead design has been successfully life tested to 150 million characters without failure, according to the manufacturer. Special character sets, EBCDIC, and other codes are available. The units are priced at \$1,900 and \$2,400, respectively. JUKI MACHINERY CORP. OF AMERICA, Costa Mesa, Calif.

FOR DATA CIRCLE 228 ON READER CARD

Disc Storage

The BST/458 looks like a winner of a disc drive when compared to IBM's

5448 unit. The plug-compatible unit features more than twice the 9.8 megabyte capacity of the 5448 (at 20.47 megabytes), and the access time of the BST/458 is 35 msec, compared to the 5448's average of 126 msec. The data transfer rate of the new drive gives its origins away: the 312,000 bytes/second is the same as the original 2314

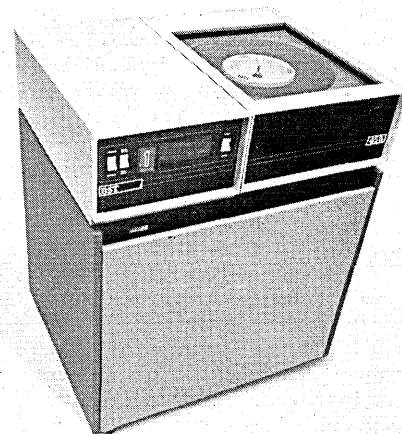

design. IBM's 5448 transfers data at 199,000 bytes/second. It's estimated that the closest 5448 configuration to the 458 would cost approximately \$5K more a year, with 5.5 fewer megabytes of capacity and the slower access time. BUSINESS SYSTEMS TECHNOLOGY, INC., Irvine, Calif.

FOR DATA CIRCLE 227 ON READER CARD

When you think computers think AUERBACH



We don't make or sell computers, but we have the world's largest data base of information on computer technology.

If you need information concerning performance, capability, specifications, prices or competitive equipment and services . . . you should know what we know.

The AUERBACH Computer Technology Reports, a comprehensive series of continually updated subscription services, provide you with a complete analysis of every major data processing device and service now available. You choose the service that focuses on your area of interest: General Purpose Computers, Distributed Processing, Data Communications, Software, Minicomputers, Input/Output, Time Sharing or the entire AUERBACH Library.

Each AUERBACH service is a complete and comprehensive information resource containing —

- In-depth Product Reports
- Evaluation and Selection Reports
- Comparison Search Charts
- Specification Charts
- Configurations
- Pricing Information

The AUERBACH Computer Technology reports are international in scope and always up to date. That's why thousands upon thousands of data processing professionals all over the world think AUERBACH when they think computers.

For more details, mail the coupon today.

AUERBACH PUBLISHERS INC.

DD-976

6560 North Park Drive, Pennsauken, N.J. 08109
609-662-2070 Telex: 831 464

Yes, I'd like more information on the AUERBACH Computer Technology Reports checked below.

- | | |
|--|---|
| <input type="checkbox"/> General Purpose Computers | <input type="checkbox"/> Time Sharing |
| <input type="checkbox"/> Data Entry | <input type="checkbox"/> Small Business Computers |
| <input type="checkbox"/> Intelligent Terminals | <input type="checkbox"/> Input/Output |
| <input type="checkbox"/> Minicomputers | <input type="checkbox"/> Microform |
| <input type="checkbox"/> Distributed Processing | <input type="checkbox"/> Software |
| <input type="checkbox"/> Data Communications | <input type="checkbox"/> Other |
| <input type="checkbox"/> Entire AUERBACH Library | |

NAME _____ TITLE _____

COMPANY _____

ADDRESS _____

CITY _____ STATE _____ ZIP _____

TELEPHONE # _____

software & services

Updates

Data Processing is "moooooooving" into the dairy industry—at least in Holland. The Dutch firm of D.A.C.A. Electronic Engineering & Contracting Co., Lelystad, has recently installed a system that supervises and records the food intake given through mechanical feeding actuators to a maximum of 254 cows. The key to the system is knowing which cow is standing at which feeding stall, and this problem was solved by having each cow wear a small transceiver on its collar. As soon as a cow approaches the feed stall, its number is picked up by a detector unit and relayed to a central computer. (The transceivers use electromagnetic energy transfer principles, thus eliminating batteries.) The central computer's data base contains information on the proper feeding profiles of the individual animals, and signals are generated to feed that particular cow a predetermined quantity of feed concentrate, delivered to that stall from an overhead pipe.

Cullinane Corp., Boston, has acquired the North American rights to the SHADOW II teleprocessing monitor from Altergo Ltd., London. A competitor for IBM's CICS, Cullinane intends to integrate SHADOW II with its own IDMS data base management system to offer a data communications and data base capability all in one package.

We've had one nomination and one vote for "Software of the Year" for Nelli Kim, the Soviet gymnast, with an honorable mention for Olga youknowwho. Any other nominations and votes before we run a tally in the December issue?

About some information passed to us regarding the CORAL 66 compiler (June, p. 180), Digital Equipment Corp. wishes to point out that it, Varian, and four other vendors are approved suppliers of the language.

General Electric has designed a set of programs for calculating the environmental effects of extra-high and ultra-high voltage power transmission lines. TRENDS (Transmission Line Environmental Digital Studies) is available on the company's MARK III international time-sharing system.

Teleprocessing Monitor

ACTS-11 (Application Control and Teleprocessing System) is to PDP-11/70 systems what IBM's CICS is to 370s, a teleprocessing task monitor that allows the user to easily implement on-line data base, data entry, and message switching systems. Programs can be written in FORTRAN or Macro-11 and may be serially reusable between ACTS-11 subroutine calls. Featured are 2260/3270 support with mapping, dual access mirrored disc and tape with restart/recovery from both devices, addressable system common storage, a resident and overlay task feature, etc. Basic systems are priced at \$25K and include two months of installation and training at customer sites. Maintenance is also provided. WORLDWIDE COMPUTER SERVICES, Wayne, N.J.

FOR DATA CIRCLE 231 ON READER CARD

Disc Management

DFAST/VS is a disc management system offered IBM DOS/VS users that provides a number of interesting features. DFAST/VS allows users to utilize any date-expired disc space as a partition-independent, and even cpu-independent, resource from which any type of file space (outside of VSAM), can be allocated. Temporary and permanent disc file space can be dynamically allocated between two or more cpu's, and the BAL package resides in the shared virtual area to reduce transient area interference. File space can also be allocated across disc-pack boundaries, and passwords can be used to protect files from being accessed by anyone.

But perhaps the most interesting feature of DFAST/VS is that it dynamically allocates logical unit blocks for programs at execution time, ignoring the numbers specified by the user in the JCL. This means that there are no conflicts between logical unit block assignments among programs running in separate partitions. (Some users have had to go back through their software and manually alter the numbers to run programs simultaneously, an error-prone procedure.) DFAST/VS also generates a number of statistical outputs that can help manage a system more efficiently, such as "percent efficiency function of block per track vs. track capacity," and "percent use function of tracks used vs. requested," etc. DFAST/VS versions rent for as little as \$225/month for the basic module, or \$350/month for a version that can manage all public space on all discs in

a system. Purchase prices are \$5,625 and \$8,750, respectively. OXFORD SOFTWARE CORP., Fort Lee, N.J.

FOR DATA CIRCLE 232 ON READER CARD

Data Security

The Resource Access Control Facility (RACF) is an IBM software product designed to "extend and help improve" data security in large user shops—significantly the package only operates under IBM's MVS system, at least for now. What RACF essentially does is identify and verify users of the system, authorize access to storage device data sets, log detected unauthorized attempts to access the system, and log access to protected data sets. To accomplish this, profiles are established for each user, group and data set that has been defined to RACF. The profiles contain information for user ID and verification, authorization checking, and logging. User, group, and data-set profiles are stored on the RACF data set and special TSO commands are provided to allow users and management to add, delete, modify, and list the profiles.

There won't be any shortage of information that can be generated by RACF. The system can be commanded to show the date a user, group, or data set was defined to RACF, and optionally the following: the date and time a user last entered the system; the number of times the user entered the system; the dates a data set was last referenced and/or updated; the number of times a data set was accessed; and the number of times each user accessed the data set. Somehow it seems like an awful lot of information on "detected" unauthorized file accesses, the kind that can easily be traced to the guilty party. But since there are programmers who have repeatedly broken Honeywell's MULTICS system with its hardware locks, we wonder just how effective RACF will be. RACF rents for \$875 a month. IBM CORP., White Plains, N.Y.

FOR DATA CIRCLE 233 ON READER CARD

Mini Structured Fortran

The addition of programming statements such as ELSE, ENDIF, DOFOR, DOWHILE, DOUNTIL, PROCEDURE, and PERFORM makes it possible to implement GOTO-less coding on Data General minis having at least 20K of memory and the RDOS Revision 3 or higher operating system. Other statements in SFORT control listing of the program. The DATEOUT statement, for example, passes to the user's program



By Kenneth Sholes, Vice President
Systems Planning Department
Schrodgers Inc. & Associated Co.
New York

**"We cut staff & related costs
50% in 18 months.
Now 6 analysts
do the work of 15."**

"In 1971, even with 15 analysts and a 360, turn-around was slow, and we had a hard time implementing and maintaining a flexible data base.

"It was an awkward situation for a central DP services organization responsible to two banking institutions (\$557 million combined assets) and three affiliated financial companies, all in constant need of timely information for proper decision-making.

"Worse yet, our expenses were soaring.

"With the installation of MARK IV, we began to react overnight to requests for reports. Within a relative short period we reduced our development staff and associated expense by 50 percent. Today six analysts are producing more, faster and better work than we used to get with a staff of 15.

"Our most significant accomplishment with MARK IV is our Total

Banking System. Two of our analysts implemented 18 different systems into a single, fully integrated banking and financial service for all of our operating companies.

"Before MARK IV, each of our 18 business areas would probably have required a separate system. Working in Cobol, we should conceivably have 18 card-to-tapes, 18 edits and 18 updates. MARK IV lets us funnel all functions into the centralized system and make just one data base pass. Only 1/18 as many cards to punch, 1/18 the chance of error, 1/18 the run time, and 1/18 the headaches.

"One of the 18 systems, Foreign Exchange, already existed in Cobol. We had spent 8 months putting it up, but it proved to be an extra thumb in our integrated plan. Using MARK IV, we revised it in a matter of weeks to conform with the centralized system.

"All of our banking business and internal auditing are now in MARK IV. So is 85 to 90 percent of our financial and management reporting. We'd like it to be 100 percent.

"Of all the benefits of MARK IV, I particularly enjoy being able to respond to management needs when they need it — like immediately. When I sit in on meetings and I'm asked if I can produce reports, in almost every case I can unequivocally say yes. That's comfortable for me. It's more comfortable for the company."



WHAT IS MARK IV?

MARK IV is the most versatile and widely used software product in the world for application implementation, data management and information processing. Six powerful models (prices start at \$10,000) are in daily use on IBM 360/370, Univac 70/90, Siemens 4004 and Amdahl 470 equipment at 1,000 sites in 42 countries. Programs in MARK IV require only about 1/10 the statements of Cobol. Users say no other system offers the power, flexibility and simplicity of MARK IV.

informatics inc

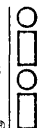

For an independent report

and a MARK IV Information packet, use the coupon below.

SYSTEM PRODUCTS

- 21050 Vanowen St., Canoga Park, Calif. 91304
- Offices in Atlanta, Chicago, Dallas, Los Angeles, New York, Washington, D.C., Toronto, Canada
- Informatics S.A. Geneva, Switzerland
- 267, route de Meyrin, CH 1217 Meyrin 2
- London, Paris, Dusseldorf, Copenhagen, Stockholm
- Computer Applications Co., (CAC) Ltd. Chiyoda-ku, Tokyo, 101 Japan
- Datec Pty. Ltd. Australia
- Sydney, Melbourne, Brisbane
- Systems Programming (Pty.) Ltd. Johannesburg, South Africa

Informatics Inc. System Products Dept. D-7
21050 Vanowen St., Canoga Park, Calif. 91304

Name _____

Title/Position _____

Firm _____ Dept. _____

Address _____

City _____ State _____ Zip _____

software & services

the date and time it was compiled providing automatic revision level updating. Optionally, a sorted cross-reference listing is produced for variables, subroutine calls, procedure references, I/O statements, GOTO statements. SFORT is priced at an even \$1K, including shipping and handling. HYCOM INC., Irvine, Calif.

FOR DATA CIRCLE 234 ON READER CARD

Transaction Processing

The Transaction Interface Processor (TIP) is a multi-thread interactive transaction processing system that allows Univac Series 90 users to develop complete on-line systems using COBOL and/or assembler without special concerns regarding the interface to the communications network. The first version is for 90/30 users and is called TIP/30, but the developers foresee compatibility with larger products in the Univac line.

Users send information to, and solicit input from, remote terminals at the logical 'CALL' level. Complete COBOL and assembler interfaces to the on-line network free the user to develop communications applications as

one would a batch program. The four components of the system consist of TIP, the communications system moni-

tor; FCS, the integrated file control system maintained by TIP; TCP, the TIP command processor (analogous to

software spotlight

Data Access

If you've ever had to deal with an airline reservation system that could only find your reservation providing you absolutely knew your flight number, and not your name (Air Canada used to do things that way, for example), then you can get some idea of what the Data Index package can do. It allows a firm to maintain records and programs accessible, for example, by order, policy, account, part numbers, or any other sort fields, and not have to face the customer with blank stares when all they know about the account is either their own name or the name of the company.

Here's how it works. The developers assist you in generating an index for the Data Index program that is functionally similar to a new sort field on the record items. The index can go across multiple applications such as order entry, accounts receivable/payable, payroll, or whatever. Designed to operate

primarily in an on-line environment, the package can also be used in batch mode to show all names that can possibly relate to an account in a single inquiry. There is no need for separate batch update programs for on-line versions.

The package uses a 'phonetic' coding system that provides "sounds like" retrieval of records. This function can be tuned to yield 100 percent "hits," 80 percent, or whatever the customer desires (the vendor recommends 70 percent for starters). This helps cut down processing time on extremely large files of more than one million names. Secondary search criteria are also handled by Data Index. It's priced at \$4,500 or \$165/month on straight rental. A lease/purchase plan is also available. Approximately 32K bytes of memory is required for IBM DOS and OS batch operation. The developers don't see any reason why Data Index won't run with practically any teleprocessing monitor, but the only two actually implemented so far are IBM's CICS and the Environ/1 package. CASE, WACHTER & ASSOCIATES, INC., Woodland Hills, Calif.

FOR DATA CIRCLE 230 ON READER CARD

MMS GENERAL LEDGER gives you extra muscle for wrestling with budgets

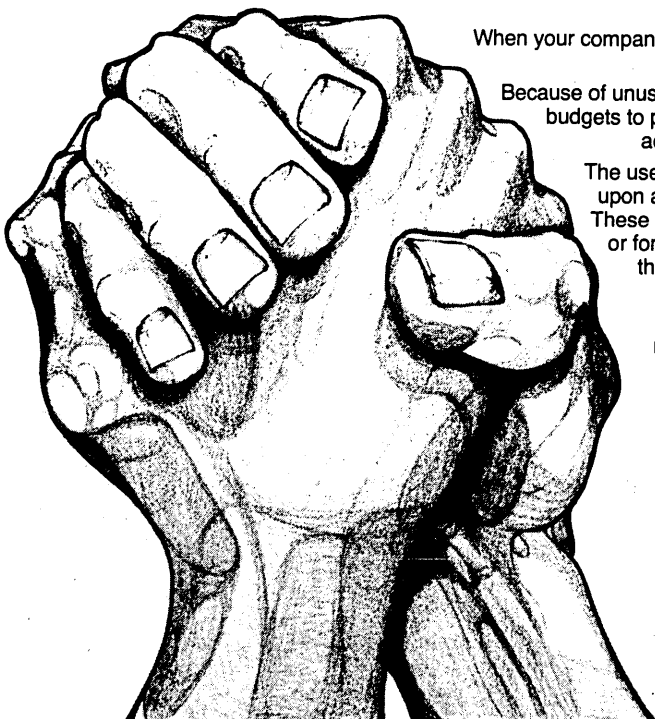

When your company's accountants wrestle with operating budgets, give them some extra muscle with the MMS GENERAL LEDGER.

Because of unusually flexible design, the MMS General Ledger allows loading of budgets to particular accounting periods or the spreading of budgets across accounting periods based on guidelines established by the user.

The user can also automatically create budget input transactions based upon actual performance and/or original budget, plus a desired factor. These transactions can be subsequently applied to next year's budget, or for revision of the current budget. Finally, the allocation routines of the powerful MMS GENERAL LEDGER can easily revise budgets based on current productivity.

Best of all, Financial Reporting Systems from Software International operate under DOS, O/S, IMS, DL/1 and TOTAL. More than 500 corporations around the world have installed our packages on IBM 360/370, System/3, Honeywell, and other computer systems.

Get your hands on the MMS GENERAL LEDGER. You'll see that those budgeting problems are pushovers.

SOFTWARE INTERNATIONAL

Elm Square, Andover, Mass. 01810 (617) 475-5040

New York (914) 332-0040 Chicago (312) 729-7410 Los Angeles (213) 981-6117
Toronto (416) 862-0521 Philadelphia (302) 995-7101 Dallas (214) 233-5856

CIRCLE 103 ON READER CARD

THE BEST COURSE OF ITS KIND IN THE WORLD



JAMES MARTIN

**ON DIALOGUE,
NETWORKS,
DATA BASE,
DISTRIBUTED PROCESSING
AND THE CHALLENGE OF THE
FUTURE**

**CHERRY HILL, N.J., (PHILADELPHIA)
4th-8th OCTOBER 1976.**

*THIS SEMINAR WILL NOT BE REPEATED ON THE U.S.
EAST COAST BEFORE OCTOBER 1977.*

**FOR FURTHER INFORMATION PLEASE TELEPHONE
(203) 227-6778. OR WRITE AIRMAIL TO:**



**Mrs. Margot Collins
ISCOL LTD
The University
Lancaster LA1 4YR
ENGLAND**

software & services

JCL); and TIPDUMP, the transaction program dump analyzer and formatter. A three-year lease on TIP/30 runs \$214/month. Users who sign up for the product before October will receive three additional features free of charge: EDIT, an interactive editor; TRACE, a dynamic trace processor; and DOC for producing justified, hyphenated, paged documents from text files. ALLINSON-ROSS CORP., Rexdale, Ontario, Canada.

FOR DATA CIRCLE 237 ON READER CARD

Microprocessor Development

The MAX-11 kit converts any PDP-11 into a development system for Intel 4040, 8080, and Motorola 6800 series microprocessors. Contained in the kit are a cross assembler, simulator, and PROM programmer. Cross assembler features include user-defined macro library, local symbols, symbolic cross referencing, listing controls, and conditional assembly. Simulator features include eight break points, single step with trace, external device simulation, interrupt simulation, and real-time cycle counter. The programmer accesses data from the PDP-11 through a

tty interface. The simulator and assembler are priced at \$1,250 and the PROM programmer at \$2,300. AIVEX, INC., Bedford, Mass.

FOR DATA CIRCLE 235 ON READER CARD

Accounting Support

Small- to medium-sized manufacturers and wholesalers (\$2-15 million gross) are offered an accounting support package for the IBM System/32. ASP-32 supports accounting functions from inventory, through purchase orders, sales, invoicing, accounts receivable and sales analyses. Standard reports are generated on a daily, monthly and yearly basis at several detail levels. ASP-32 also provides for interfacing with diskette data entry stations (3741s) which can be used to generate ASP-32 input off-line.

Included in the ASP-32 is a Seasonal Manufacturing Control System (SMCS) which is probably most applicable to garment manufacturers. Developed by Joseph Love, Inc., the system is said to be a distillation of what has been learned from being in the field 55 years.

ASP-32 comes with a license agreement and costs \$12K, including documentation, installation, two weeks of on-site training, and help in the conversion of manual to computerized files. Complete turnkey systems are al-

so offered. QUANTRA DEVELOPMENT CORP., New Rochelle, N.Y.

FOR DATA CIRCLE 236 ON READER CARD

File Management Feature

"Special Feature 26" is now available to MARK IV File Management System users. The option designation translates to an advanced table lookup feature that gives the user access to tables as part of the MARK IV language, with such access totally transparent to the user, it's claimed. ATL includes not only the matching capabilities found in table lookup systems, but additionally features the ability to retrieve results based on non-match conditions, such as results that are closest and higher or lower, as well as interpolated results that do not actually exist in a table at all. ATL tables are comprised of two parts, table arguments and table results. Results obtained are based on matching an element of data to one of the table arguments and retrieving the associated result for output or subsequent processing.

Available under release 6.0, the new feature is priced at \$3,700 and is compatible with "Special Feature 001," table lookup. MARK IV is running on more than a thousand Univac, IBM, and Amdahl computers. INFORMATICS INC., Canoga Park, Calif.

FOR DATA CIRCLE 238 ON READER CARD

Even Webster's Knows About QUEST

QUEST (kwest). v. 1. To make a search; to go on a quest.

QUEST SYSTEMS, INC. n. 1. A corporation founded in 1968. 2. The largest professional recruitment firm in the U.S. functioning solely in the computer sciences; its client companies pay all employment fees, interviewing and relocation expenses. Quest is known for its deep personal commitment to relate to each candidate as an individual with individual goals. 3. Its professional staff averages over 6 years of experience in EDP recruiting (additionally, staff members have direct hands-on experience in programming, systems, hardware sales, etc.) 4. Quest is presently searching for programmers and analysts (commercial, scientific, systems software) for over 3,500 client companies in the U.S. Quest has openings in over 700 U.S. towns and cities. 5. Methodology — see Questsystem.

QUESTSYSTEM (kwest sis'tem). n. 1. Discussing with an individual what he would like to be doing in light of what he has been doing. 2. Analyzing the realities of his objectives as they relate to the current job marketplace. 3. Contacting client companies and other Quest staff personnel to identify positions of possible interest. 4. Introducing the job candidate to his prospective employers by providing complete details to each about the other, ensuring the efficacious use of everyone's time. 5. Arranging interviews. 6. If employment offers are extended, Quest assists in evaluating the responsibilities, compensation and opportunities (and relates those to the initially stated objectives). The Questsystem has been working for thousands of professionals at no expense, whatsoever. Ask your friends of their past dealings with Quest. Then, put the Questsystem to work for you. For additional information on this subject, please inquire directly to Quest Systems, Inc. (All inquiries/resumes received will be responded to immediately and in confidence.)



QUEST SYSTEMS INC.

6400 Goldsboro Road
Washington, D. C. 20034 (301) 229-4200

Baltimore: (301) 265-1177 • Philadelphia: (215) 667-3322

CIRCLE 160 ON READER CARD

SYSTEMS ANALYST

(MARKETING INFORMATION SYSTEM)

R.J. Reynolds Industries, Inc. has an opening within its Corporate Systems Department in the area of marketing related systems. Corporate Systems is presently forming a project team to develop and implement a highly sophisticated Marketing Information System.

Applicants should possess the following:

- Undergraduate degree in Business, Marketing, or Statistics.
- Experience with data base systems, i.e., IBM's C.M.S., DL/1, and G.I.S.
- Knowledge of Cobol, Basic and Fortran.
- Good Communication and analytical skills.
- Ability to interface with all levels of management.

Excellent benefits package, including assistance in sale of present home and paid relocation.

Send resume and salary history, in confidence, to:

Denis G. Simon
Corporate Employment Department
R.J. Reynolds Industries, Inc.
401 North Main Street
Winston-Salem, North Carolina 27102

Tobacco Products •
Food Products •
Containerized Freight •
Transportation

RJR

Petroleum •
Aluminum Products •
Packaging Materials

RJReynolds Industries, Inc.

an equal opportunity employer

THE TEACHER IS WEINBERG, THE SUBJECT IS YOU.

Jerry Weinberg and his associates will conduct Ethnotech's highly regarded Technical Leadership Workshop the week of October 17-22 in Lincoln, Nebraska. The entire program has been arranged under the auspices of Yourdon inc. Enrollment will be strictly limited.

THE TEACHER

Jerry Weinberg is the president of Ethnotech—the leading organization in the world today on the human factor in computer programming. He has outlined Ethnotech's principles in his book, "The Psychology of Computer Programming" and the recently published "An Introduction of General Systems Thinking."

But the written word alone does not provide an adequate picture of this approach. Ethnotech believes people can be more productive. And, that this productivity results from a delicate balance of technical, behavioral, and humanistic learning. A balance all too often ignored in ordinary computer training.

The effectiveness of this individual approach as reflected in the Technical Leadership Workshop was best put by a student who complained, "Lunch was much too long."

THE WORKSHOP

The Technical Leadership Workshop has grown out of the experience Jerry Weinberg and his colleagues at Ethnotech have had in over 60 person-years of consulting and training in various organizations throughout the world.

The Workshop lasts five-and-a-half-days. Classes will last each day from 9 a.m. to 1 a.m. (16 hours)—a total immersion experience for students and instructors.

The Workshop will concentrate on the technologies of open egoless cooperative programming, programming teams, structured programming, and top-down program design and development. The approach to these subjects involves each student in problem-solving activities that will ultimately have practical application.

Each day will involve: technical material; survey of literature; discussions; exercises; peer review practice; introduction strategies; and simulation gaming to teach means of overcoming resistance, avoiding pitfalls, and recognizing counter indications.

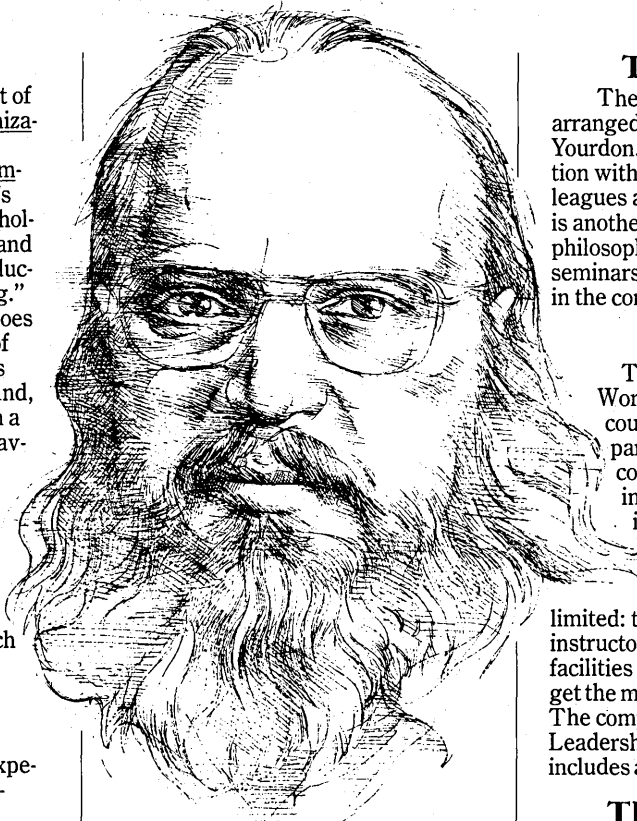

Jerry Weinberg will give the Workshop in person; he will be joined by Daniel Freedman, a senior member of Ethnotech.

THE RESULTS

In previous offerings of this course, 206 of 243 participants rated it "the best educational experience ever." In many cases, the resulting work improvement by course participants in their respective organizations has repaid the course investment many times over.

Here are some student comments of Weinberg's Technical Leadership Workshop: "a tremendous experience in introspection. Thank you." "This course has made me see the people I work with in a different light." "A fascinating course—unlike any I've ever taken—and better." "A profound educational experience."

THE SPONSOR

The entire program has been arranged under the auspices of Yourdon. We are proud of our affiliation with Jerry Weinberg and his colleagues at Ethnotech. We feel it is another example of Yourdon's philosophy of bringing you first-rate seminars taught by the finest minds in the computer industry today.

THE VALUE

The Technical Leadership Workshop is actually a two-week course given in one week. Each participant will have 80 hours of contact with two of the finest instructors in the computer industry today. (Incidentally, participants are first rate, too. Or else they wouldn't be there.) Class size is strictly limited: twelve participants per instructor. Only the finest training facilities and materials are used. You get the most for your educational dollar. The complete fee for the Technical Leadership Workshop is \$1500. This includes all accommodations and meals.

THE PARTICULARS

COURSE: Technical Leadership Workshop

TEACHERS: Jerry Weinberg and Daniel Freedman

DATES: Sunday, October 17th through Friday October 22nd.

LOCATION: Hilton Hotel, Lincoln, Nebraska

FEE: \$1500

If you would like further information call Vera Kacalek, collect, at Yourdon inc (212) 730-2675, or write Yourdon inc, 1133 Avenue of the Americas, New York City 10036.

We're the people who train the people who train the people.

President

Executive
Vice
President

Marketing
Manager

Finance
Manager

Information
Manager

In the 1960's
people that
could move
merchandise
had the
inside track
to the top of
the corporate
ladder.

In the 1970's
people that
can manage
money
have the
inside track
to the top of
the corporate
ladder.

In the 1980's
people that
can manage
information
will have the
inside track
to the top of
the corporate
ladder.

Every decade, the top jobs seem to require a new skill. Will the next one be information management?

Every decade, a different corporate job function seems to capture the attention of top management. Today, the one that's creating the most excitement is information management.

Bridging the gap between producers and users.

Tomorrow belongs to the Information Manager. Combining a knowledge of information systems of all types with a knowledge of corporate management, these people will bridge the gap between the producers and users of information.

To do this, they'll need constant updating on systems and techniques in this rapidly expanding field. As of today, there's only one place they can get all of the information they will need.

The only exposition for information management.

The 1976 Information Management Exposition & Conference will be held November 8 to 11 in an ideal meeting facility, Chicago's McCormick Place.

Info 76 has been carefully planned to help you two ways. First, you'll learn about systems and techniques that can help you do today's job more efficiently. Second, you'll prepare yourself for the challenges and opportunities ahead.

For more information, write Clapp & Poliak, Inc., 245 Park Avenue, New York, N.Y. 10017. Or call 212-661-8410.

Why you should be at Info '76.

Exhibitors will display state-of-the-art equipment:

Computers.
Data communications.
Data terminals.
Dictating equipment.
Duplication/copying systems.
Information retrieval systems.

Microfilm systems.
Minicomputers.
Softwear & data services.
Word processing systems.

Over 80 conferences on:

Banking systems.
EDP management.

The "Electronic Office."
Financial systems.
Hospital systems.
Insurance systems.
Minicourse on word processing.
Physical distribution.
Small business and computers.
Why EDP projects fail.

info
76 Third International
**Information Management Exposition
& Conference.** McCormick Place, Chicago, Nov. 8 to 11

Announcing
Comm-Stor™
the RS-232 Floppy Disk System
 by Sykes



Without Comm-Stor, your DECwriter or TermiNet or Silent 700 or CRT display or . . . is just another dumb terminal.

How much does intelligence cost? \$2,500* buys you an IBM compatible flexible disk system which interfaces directly with all asynchronous RS-232 terminals, printers and modems.

Comm-Stor is much more than just a bulk storage unit. It's a microprocessor based system which has capabilities ranging from batch processing to converting your dumb terminal into a complete file management system.

Comm-Stor automatically keeps a directory of user-assigned message names for ease in storing and retrieving data. The directory allows the user to retrieve a message or group of messages in either the

order it is stored or in alphabetical order by message name.

Comm-Stor will respond to commands from terminal and modem ports, and is operator configurable to specific system parameters such as English (or foreign) language commands, special codes, command set, control functions and RS-232 interface parameters.

Some of the main features of Comm-Stor are:

- User Configurable
- Directory Listing of Message Names
- Alpha or Sequential Message Sort
- High Speed Random Message Search

- Off Line/On Line Operation
- Up to 9600 Baud Operation
- Over 240,000 Char./Disk
- Single or Dual Drive Unit
- Forms Operation (optional)
- Full Message Editing (optional)
- Printer Port (optional)
- Current Loop Interface (optional)

There's a lot more to tell about Comm-Stor. Write or call for your 8-page brochure.

*Single drive, quantity one, U.S.A.

SYKES DATATRONICS INC. • 375 ORCHARD ST. • ROCHESTER, N.Y. 14606 • 716 458-8000
 TELEX 97-8326

SYKES®

The Marketplace...

advertisers' index

SOFTWARE MARKETPLACE

American Used Computer	227
Atlantic Software	227
Automated Concepts Inc.	225
Bancroft Computer Systems	225
Dataware Inc.	225, 226
Diversifiedata	226
HENCO, Inc.	225
Informatics Inc.	226
International Management Services, Inc. .	225
Macro Corporation	225
Mathematica	226
Mnemonics Incorporated	227
Newman Computer Exchange	226
Programming Resources Company	225
Software International	226
Varatek Computer Systems, Inc.	227

DP MARKETPLACE

MDB Systems, Inc.	227
Randolph Computer Company	227
TransNet Corp.	227

SOFTWARE MARKETPLACE

AUTOCODER-TO-COBOL

The system converts source Autocoder (1401, 1440, 1410, 7010, and SPS) to ANS COBOL (DOS or OS). The converter uses a unique method to examine and interpret source code before producing COBOL. Converter features are:

- HANDLES COMPLEX LOGIC CODE; USER MACROS, INDEXING AND CHAINING
- LISTING OF THE OUTPUT COBOL VS SOURCE STATEMENTS (SIDE-BY-SIDE)
- SOURCE NAMES & COMMENTS ARE PART OF THE COBOL PROGRAM
- PROVIDES 90%++ SOURCE CONVERSION

Dataware offers 2 service forms: Clean Compile and Full Implementation. License and Lease are also available.



DATAWARE INC.

495 Delaware St., Tonawanda, N.Y. 14150
(716) 695-1412

CIRCLE 163 ON READER CARD

RPG II SYSTEMS

- ACCOUNTS RECEIVABLE
- GENERAL LEDGER
- PAYROLL
- INVENTORY
- UTILITY BILLING
- COMPUTER JOB ACCT'G
- LINE GRAPH, LETTERS, MEMBER LISTING, CREDIT UNION, OTHER

Multicompany Systems With Both User and Systems Documentation Comprehensive Systems at Modest Prices

Bancroft Computer Systems
P.O. Box 1533, Dept. D
West Monroe, La. 71291
(318) 388-2236

CIRCLE 164 ON READER CARD

software services

We specialize in:

- Systems Design
- Programming
- Package Development
- Program Conversion

Languages used:

- APL • ASSEMBLER • BASIC • COBOL
- FORTRAN • NEAT/3 • PL/1 • RPG

With unlimited manpower resources we can guarantee these results:

- Cost Savings • Maintainability • Security
- Program Efficiency • Quality
- Future Support

If you really want to save money in software—give us a call today (213-483-8884)

PROGRAMMING RESOURCES COMPANY
1833 West 8th Street, Los Angeles, CA 90057

CIRCLE 179 ON READER CARD

60 MAJOR COMPANIES

agree . . . MACRO SERVICES yield successful Computer Automation!

Macro serves as your computer engineer or in support of your staff.

CONSULTING

- Planning
- Purchasing
- Specification
- Project Management

SOFTWARE/SYSTEMS

- Specification
- Design
- Engineering
- Programming
- Documentation

EXPERIENCE—Energy Management, Process Control, Security, Material Handling, Communications, Testing, . . .



Macro Corporation

1260 VIRGINIA DRIVE • FORT WASHINGTON, PENNA. 19034
(215) 646-9510

CIRCLE 173 ON READER CARD

IMS EDUCATION

Automated Concepts Inc. has developed a complete curriculum of IMS training courses. Out of ACI's heavy involvement in IMS consulting services have come the experience and practical knowledge required to create this unique series of courses. The teaching method employed is an onsite lecture and workshop presentation by an ACI instructor. ACI offers the option of customization of course materials to reflect your installation's software environment, programming and operating procedures, etc.

ACI's IMS curriculum includes:

- Introduction to IMS DB/DC Systems
- IMS Programming Workshop
- Advanced Topics for IMS Programmers
- IMS Debugging
- IMS 3270 Design
- IMS Reorganization, Recovery & Restart
- IMS for Operators

Send for ACI's "IMS Curriculum Guide" or contact: Karen Weingart, Product Manager.

aci

Automated Concepts Inc.

386 Park Ave. South, New York, N.Y. 10016
212-725-4540

CIRCLE 162 ON READER CARD

LOCATE and EVALUATE MINICOMPUTER SOFTWARE

- Over 300 completely detailed program descriptions.
- Operational requirements.
- Indexed by Application.
- Cross referenced by: Minicomputer CPU (S) Source Language

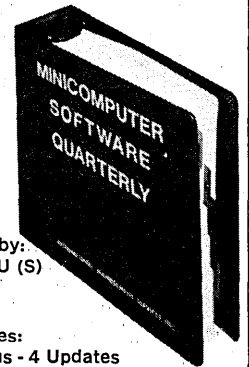

Subscription Includes:

Base Volume - Plus - 4 Updates
\$75. U.S./Canada - \$100. Foreign

INTERNATIONAL MANAGEMENT SERVICES, INC., - Dept. D
70 Boston Post Road, Wayland, Mass. 01778

CIRCLE 171 ON READER CARD

WORD PROCESSING PLUS

HENCO'S new Automated Document Composer (ADC) may look like the competition, but all comparison ends there. ADC is built around a general purpose minicomputer, not a micro or a naked something-or-other, so it can do more, do more faster, and is far easier to learn and use. That means you can tailor its operation to suit your scheme of how the work gets done.

Standard features include right and left margin justification, user-assigned operations, footnote insertion on referencing page, page composition, text insertion and modification, automatic index preparation, sequential and random insertion from secondary files, multiple access, and on and on and on . . .

Automating your paperwork is as simple as ADC.



HENCO, the versatile business system specialists
HENCO, INC.
215 Oak Street
Natick
Massachusetts 01760
(617)-653-4323

CIRCLE 170 ON READER CARD

WHAT'S SCORE® IV?

- FOR FAST REPORT WRITING
- FOR EFFICIENT FILE MAINTENANCE
- FOR COBOL PROGRAM GENERATION

If your company wants to:
MEET EDP BUDGET PROJECTIONS!!
CUT MACHINE RUNNING TIME!!
SHORTEN PROGRAMMING TIME!!
RELIEVE PRESSURE ON THE DP DEPT.!!

LET US SHOW YOU
WHAT THE SCORE REALLY IS.



21050 Vanowen Street
Canoga Park, California 91304

CIRCLE 165 ON READER CARD

INTERCOMM

INTERCOMM is the most advanced TP monitor available for OS and OS/VS. It provides the ultimate DB/DC environment with full integrated support for ADABAS, IDMS, MODEL 204, TOTAL, SYSTEM 2000, and DL/1; full recovery is provided for messages, queues, standard files, and data bases. INTERCOMM permits separately servicing multiple, on-line systems concurrently in a shared communications environment: each system cannot address the other's core, files or data bases. INTERCOMM provides extensive utilities that greatly simplify programming requirements for COBOL, PL/1, ALC, or FORTRAN. Special performance options make INTERCOMM highly desirable for large volumes or networks, particularly in VS. A wide variety of terminal types is supported.



21050 Vanowen Street @
Canoga Park, California 91304.

CIRCLE 169 ON READER CARD

ATTENTION: OS SYSTEMS PROGRAMMERS

The Multi-Function Data Set Utility Language (MFDSUL) is a comprehensive data set processing language and utility system. MFDSUL provides systems programmers with a powerful tool with which they may write custom data management and intelligent utility programs; in a very simplified subset of the IBM assembler language. The MFDSUL language consist of 25 instructions which require no register assignments, linkage editing, or addressing labels. MFDSUL requires 1/2 the coding time of IBM assembler, is "Assemble & Go," runs at I-O speed and requires only 40K. It supports 2 inputs, 6 outputs on any device type and of any OS File organization. Also has many other features too numerous to mention. MFDSUL installs in five minutes. The license fee includes: lifetime maintenance, complete comprehensive documentation, and vendor support.



Suite 406, 240 Stoneridge Road
Columbia, South Carolina 29210
803-798-2876

CIRCLE 121 ON READER CARD

ECONOMICAL ON-LINE

MINICOMM, the System 360/370 DOS/VS Teleprocessing Monitor with economy of core and price. All 360/370 program languages are supported, even RPG II. LOCAL, REMOTE and DIAL-UP 3270 and 2260 networks will be processed efficiently through a combination of features which are unique to MINICOMM Sign/on-sign/off security, 3270 mapping, multi-tasking, message switching, on-line testing and a Data Entry facility are but a few of the many features available. Education and installation at the user site are provided by the vendor.



21050 Vanowen Street
Canoga Park, California 91304

CIRCLE 167 ON READER CARD

RPG/RPGII TO COBOL

Package accepts Sys/3 RPGII, MOD 20 DPS RPG, 360/370 DOS and OS RPG and can produce either DOS or OS ANS COBOL. Inherent functions such as Match Record, Chaining, Subscripting, as well as Table Handling are converted by the system. A cross-reference worksheet of the original RPG statements aligned with the resulting COBOL is produced. Dataware offers 2 service forms: Clean Compile and Full Implementation. Lease and License are also available.

We also have translators for:

- Autocoder/SPS-To-COBOL
- Easycoder/Tran-To-COBOL
- BAL/ALC-To-COBOL
- PL/1-To-COBOL
- Autocoder (7070)-To-COBOL
- COBOL-To-COBOL
- RPG/RPGII-To-PL/1



DATAWARE INC.

495 Delaware St., Tonawanda, N.Y. 14150
(716) 695-1412

CIRCLE 165 ON READER CARD

RAMIS IS . . .

the world's leading family of data base systems. It combines a simple user-oriented language for data retrieval and report preparation with capabilities for complete control over the input and maintenance of the data base. Developed in 1967, RAMIS is currently used by 500 companies for 200,000 computer hours a year. RAMIS is easily used by non-EDP professionals and data processing staff alike. Only a few hours of training are required to solve urgent management information problems in

Finance / Manufacturing / Sales management / Production management / Inventory control / Personnel administration / Energy administration / Project control / Research & development / And other areas

RAMIS typically reduces costs by eliminating 75 percent of standard programming needs. User experience has shown that the man-hours needed to design and implement comprehensive information systems have been reduced by 80 percent, while cutting the time from information request to completed report by as much as 90 percent. To find out why RAMIS is truly a Rapid Access Management Information System, contact us.

MATHEMATICA

Princeton Station Office Park, P.O. Box 2392
Princeton, New Jersey 08540
(609) 799-2600

CIRCLE 172 ON READER CARD

REPLACE CICS???

BETACOMM, the System 360/370 DOS/VS Teleprocessing Monitor designed to provide low cost on-line application implementation. Multi-thread/multi-task processing, broad terminal support, data base interface, comprehensive 3270 mapping, storage protection, and data entry (replacement for Video 370) are but a few of the features which make BETACOMM an ideal replacement for CICS or as an upgrade for MTCS. Extensive on-line testing facilities and programming language flexibility (ANSI-COBOL, PL/1, BAL, RPG II, FORTRAN) will reduce development costs. On-site education and installation are provided as part of the package. More than 70 installations worldwide supported by Informatics Inc.



21050 Vanowen Street
Canoga Park, California 91304

CIRCLE 168 ON READER CARD



64 Pages of News about the Amazing
Technological Breakthroughs in the
Mini-Micro Computer Field!

Send \$1.00 now (refundable on first order)
or Free with Business Card!

Newman Computer Exchange
3960 Varsity Drive, Dept. 16
Ann Arbor, Michigan 48104

CIRCLE 178 ON READER CARD

Get the famous MMS General Ledger and Financial Reporting Systems

or Payables, Receivables,
Payroll, Net Change MRP

- Over 500 Users
- 90 Fortune's 500 Companies
- Automatic Budget Generation
- Cost Accounting
- Exception/Variance Reporting
- Statistical Accounting
- Graphics . . . and more

**SOFTWARE
INTERNATIONAL**

Elm Square, Andover, Mass. 01810 (617) 475-5040

New York (914) 332-0040 Chicago (312) 729-7410

Los Angeles (213) 981-6117 Toronto (416) 862-0521

Philadelphia (302) 995-7101 Dallas (214) 233-5856

CIRCLE 177 ON READER CARD

PDP-11 TIME-SHARING

DOS users can now exploit the upper range of the PDP-11 series and expand into a multi-programming environment without costly conversion and retraining by utilizing Varatek's MX Operating System.

Each MX terminal is a virtual DOS/BATCH system capable of executing all DOS/BATCH requests (EMT's), keyboard commands, and batch commands. Simultaneous batch streams can be executed from each of the terminals.

MX provides a powerful complement of features including output spooling, inter-terminal communications, interactive debugging, interactive system generation, and many other features making it ideal as an in-house time-sharing system.

A free 16 page brochure "Introduction To MX" is available.

Varatek Computer Systems, Inc.
2 Elm Square
Andover, Massachusetts 01810

CIRCLE 182 ON READER CARD

To meet (or beat) deadlines,
to handle user requests,
to stay within budget, use

PC-70

The automated system that helps you manage people and projects effectively, PC-70 is applicable to virtually any type of project or project-oriented group, including DP, engineering, R&D, legal, facilities planning, maintenance, and construction. Simple, powerful and economical, PC-70 is today's leading project/resource management system, with over 300 clients worldwide.



Atlantic Software Inc.

5th & Chestnut Sts.
Philadelphia, PA 19106 / (215) 922-7500
Europe: Tecsi Software, Paris / 225-86-83

CIRCLE 175 ON READER CARD

The S/370 hot line.

800-243-5307

In Connecticut, dial 661-4200

Purchase-Leaseback • Lease • Sell • Buy
RANDOLPH COMPUTER COMPANY

CIRCLE 181 ON READER CARD

MARKETAB

New, expanded, Fortran version of our survey and audit tabulation system.

Cleaning phase provides complete column editing, logical cleaning, recode or summary punching and full printed report including logical hit/miss counts, full punch counts and total respondent based percentages.

Data manipulation phase provides complete recode capability, physical and/or mathematical manipulation of the data, trailer record generation and other time saving features.

Tabulation phase provides virtually infinite combinations of tab and formatting options to satisfy most survey and/or audit tabulation requirements. Market research oriented spec language reduces or eliminates spec writing and requires less than one week of training.

Operational on 360/370 OS or DOS and many other computer configurations supporting Fortran IV.

MN MNEMONICS INCORPORATED

280 CONNECTICUT AVE., NORWALK, CONN. 06854

CIRCLE 176 ON READER CARD

To build cost-justified
information systems that satisfy
user requirements, use

SDM-70

The practical, top-down approach to creating information systems, SDM-70 provides a complete set of guidelines (planning, estimating, methods, and documentation) to perform the entire systems life-cycle process . . . simply and effectively. Best of all, SDM-70 costs \$1,000's less than other alternatives.



Atlantic Software Inc.

5th & Chestnut Sts.
Philadelphia, PA 19106
(215) 922-7500

CIRCLE 172 ON READER CARD

DP MARKETPLACE

LINE PRINTER CONTROLLER FOR PDP-11 COMPUTERS

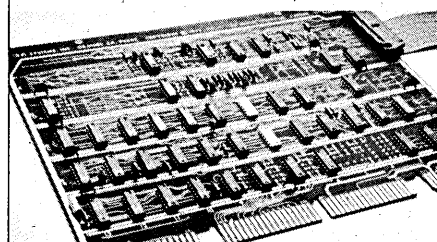

- low-cost controller for most printers
- compatible with host computer software
- operation and programming as described by DEC for LP-11 or LS-11
- takes one quad slot in chassis; cable assembly included
- other DEC peripheral controllers and interface modules available

MOB

MOB Systems, Inc.
1995 N. Batavia St.
Orange, California 92665
714/998-6900

CIRCLE 174 ON READER CARD

DECwriter II

MODEL LA36 PRINTER TERMINAL
10-15-30 CHARACTERS PER SECOND
REMOTE OR CONSOLE USE
132 PRINT POSITIONS

\$1,645 each

DECscope

VIDEO DISPLAY TERMINAL
MODEL VT50 12 LINES, 80 CHARACTERS

\$1,095 each

MODEL VT52 24 LINES, 80 CHARACTERS
NUMERIC PAD • HOLD-SCREEN MODE

SPECIAL FEATURES

\$1,795 each

DECprinter I

MODEL LA180 HIGH-SPEED PRINTER
180 CHARACTERS PER SECOND
132 PRINT POSITIONS

\$2,795 each

100% EQUITY RENTAL PLAN	
DECwriter	\$150 month
VT50 DECscope	100 month
VT52 DECscope	165 month
DECprinter	260 month
FULL OWNERSHIP AFTER 12 MONTHS	

QUANTITY DISCOUNTS
AND LEASE PLANS AVAILABLE

OPTIONAL FEATURES
INSTALLED WITHOUT CHARGE

WE ALSO MARKET ACOUSTIC COUPLERS
AND DIGITAL CASSETTE UNITS



TRANSNET CORP

2005 ROUTE 22, UNION, N.J. 07083
201-688-7800

CIRCLE 180 ON READER CARD

DEC FAMILY PDP8

CPUs, Memories, Peripherals

Over **500**

Units in Stock
90 Day Warranty

AMERICAN USED COMPUTER CORPORATION

617-261-1100

P.O. Box 68, Kenmore Station, Boston, MA 02215

CIRCLE 161 ON READER CARD

1976 Computer Salary Survey!

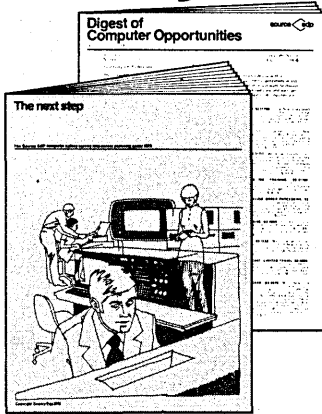

**Send for your
free copy today!**

Do you know how much money your colleagues earn for performing the same duties you perform? Do you know which computer skills are most lucrative and what you can do to gain them? Do you know the "six steps" needed to become MI Director?

Source Edp does. And we'll share what we know with you. Our tenth annual salary survey and career planning guide, "The Next Step", is now available without charge. This comprehensive study provides an in-depth analysis of the strategies and techniques you can employ right now to maximize long-term career development. You'll also receive our latest "Digest of Computer Opportunities" describing specific career openings currently available within our client organizations nationwide. Just fill out the reader service card and we'll send you your copies absolutely free. Or write:

Source Edp Corporate Headquarters
100 South Wacker Drive
Chicago, Illinois 60606
(P.S. Be sure to use home address and indicate position title).

source edp

Regional Offices:

Atlanta	404/634-5127
Boston	617/237-3120
Chicago	312/782-0857
Cleveland	216/771-2070
Dallas	214/638-4080
Detroit	313/352-6520
Fort Worth	817/338-9300
Houston	713/626-8705
Irvine, CA	714/833-1730
Kansas City	816/474-3393
Los Angeles	213/386-5500
Minneapolis	612/544-3600
NJ-NY	201/687-8700
New Orleans	504/523-2576
Northfield, IL	312/446-8395
Oak Brook, IL	312/986-0422
Palo Alto	415/328-7155
Philadelphia	215/665-1717
San Francisco	415/434-2410
St. Louis	314/862-3800
Washington, DC	703/790-5610

advertisers' index

AC Manufacturing Company	173	†Data Recording	190-F
Advanced Systems Incorporated	80	DATAMATION	118
†Agfa-Gevaert N.V.	190-P	Datamedia Corporation	177
American Management Systems Division	185	Datapoint Corporation	150
Applied Data Research, Inc.	5	Dayco Corporation	178
Applied Digital Data Systems Inc.	36, 37	Delta Data Systems Corporation	187
Auerbach Publishers, Inc.	215	Diablo Systems Incorporated, A Xerox Company	23
BASF Systems	40	Digital Equipment Corporation	138, 139
Basic Timesharing Inc.	98, 99	Du Pont	95
Beemak Plastics	179	Eastman Kodak Company, Business Systems Markets Division	213
†Benson	190-T, 190-U	Electronum	182
Bourns, Inc.—Management Systems Division	Cover 3	Evans & Sutherland Computer Corporation	183
Bruning Division of Addressograph Multigraph	28	Exide Power Systems Division, ESB Incorporated	104, 105
†Bunker Ramo International	190-FF	Extel Corporation	128, 129
Cable & Wireless, Inc.	106	Fenwal Incorporated	82
California Computer Products, Inc.	96	Floating Point Systems Inc.	78
Call Data	175	Florida Department of Commerce	118
Centronics Data Computer Corp.	6	Fox-Morris Personnel Consultants	236
CFI Memories	29-35	Friedrich Group Wylain, Inc.	238
Clapp & Poliak, Inc.	222, 223	Fujitsu Limited	20, 21
CMC, a division of Pertec Corporation	1	General Electric	156, 157
Codex Corporation	137	Genesis One Computer Corporation	77
Collins Radio Group, Rockwell International	209	GNT Automatic Inc.	198
Comnet	102	†GNT Automatic A/S	190-J
Computer Devices Inc.	206	Goodyear Aerospace Corporation	115
Comserv Corporation	212	Gould Inc., Instrument Systems Division	158
Control Data Corporation	Cover 2, 159	Graham Magnetics	146
†Control Data Corporation	190-L, 190-M	Graphic Controls Corporation	202
Crown Industries	130	Grumman Data Systems	132
Crown Publishers	179	Harris Computer Systems	112, 113
DASD Corporation	170	Harris Corporation, Data Communications Division	155
Data Communications Interface	230, 231	Hazeltine Corporation	84
Data Devices International	196	Hewlett-Packard	45-52, 148, 149, 167
Data General	16, 103	†Hewlett-Packard, S.A.	190-O

Houston Instrument, Division of Bausch & Lomb	165, 234
IBM	88, 89
IMS Associates, Inc.	19
Industrial Development Div. Committee of One Hundred	154
Informatics Inc.	12
Informatics Mark IV Systems Company	169, 217
Information Science Incorporated ..	199
Information Terminals	42
Infoton	53
Integrated Software Systems Corporation	41
Intel Memory Systems	90
†International Computer Systems .	190-X
International Data Sciences, Inc. ...	214
International Federation for Data Processing	136
Intertel, Inc.	192, 193
ISCOL, Ltd.	219
IteI Corporation	2
C. Itoh Electronics Inc.	188
Jaquard Systems	153
Kuwait Institute for Scientific Research	236
Kybe Corporation	214
The Library of Computer and Information Sciences .	141, 142, 143
Litton Computer Services	184
LRK Associates	232
Magnetic Shield Div., Perfection Mica Co.	154
Mathematica	43
MCS Designs	212
†Memorex Corporation.....	190-AA—190-DD
Methods Research	170
Microdata Corporation	203
†Microtecnica	190-Z
Modular Computer Systems Inc. .	24, 25
Mohawk Data Sciences Corporation	181
NCR Terminal Systems Division	229, 233
†Norsk Data Electronics ...	190-R, 190-S

COMPUTER ENGINEERS

Software and Systems

NCR's Point-of-Sale Division in East Central Ohio has grown considerably in just three-and-a-half years. Our Engineering facility alone has increased from 100 to nearly 400 employees. This growth suggests a high degree of satisfaction with the kind and level of work being performed. Moreover, the fact that just about all of them are still with us also indicates they are pleased with the living environment this open, rural area offers them and their families.

The Point-of-Sale Terminal Systems is an expanding market for the computer industry and, accordingly, highly competitive. To maintain our lead position in the field, we require the talents of experienced Systems Engineers and Software Engineers with mini and micro-processor exposure. We invite you to send your credentials, including your area of work interest, for consideration.

Software Systems

Software Systems Engineers will define and develop overall total systems level software architecture required for future terminal control systems. This will include operating system software, system level simulations, system level diagnostics, and communications including in-house digital links and common carrier networks.

Software Design

All terminal software development in the new generation of P.O.S. terminals is performed by the software design groups. They also develop the support software for these new terminals. Working in a small team atmosphere you will become an immediate contributor to the software product.

Knowledge and/or experience in Assembly Language programming, mini/microcomputers, and exposure to at least one of these areas—operating, I/O, communications or system test software design—are essential. In addition, experience with Procedural Language programming, software system integration and testing will be helpful.

Systems Engineers

They will define the requirements of real-time micro/minicomputer systems—both the hardware and software. This entails the conceptual design, performance analysis, design support and critical design tradeoffs.

The more senior computer professional will bring from 2–10 years experience in the systems or software areas; the entry level candidates will bring sound knowledge of their areas indicated in support of their inquiries.

We invite you to contact us at your earliest convenience for placement consideration.

Robert W. Donovan
Terminal Systems Division
NCR Corporation
P.O. Box 728
Cambridge, Ohio 43725
Phone: 614/439-0398



An Equal Opportunity Employer

CIRCLE 158 ON READER CARD

The Critical Event

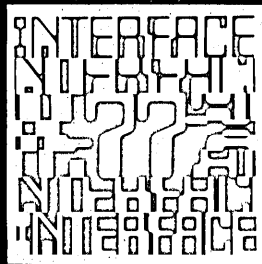

FOR
Executives
Operations Management
DataComm Professionals
DP Management and Staff
Communications Management
Systems and Design Personnel
plus all those with an interest
in the exciting, fast-growing
world of data communications to...

**DATA COMMUNICATIONS
INTERFACE[®] '77**

**Fifth Annual Conference
and Exposition**

**March 28-30, 1977
Georgia World Congress Center
Atlanta, Georgia**

Co-Sponsored by

DATAMATION

Magazine

Data communications creativity and productivity forge ahead as critical milestones are being achieved by a growing world of users and suppliers. The focal point for sharing such progress will be our **fifth** national conference dedicated to data communications. Plan to attend the event where significant issues are resolved and cost-effective directions are established. Come to Data Communications INTERFACE '77 - the critical event.

Co-sponsored by DATAMATION magazine, INTERFACE '77 continues to be the forum for information on all aspects of data communications. On March 28-30, Atlanta's fabulous new Georgia World Congress Center will host over 150 leading professionals addressing issues critical to productive use of data communications systems and services. Hundreds of exhibits worth millions will demonstrate state-of-the-art capabilities. And thousands of attendees will be exchanging the latest concepts and experiences in the real world of data communications.

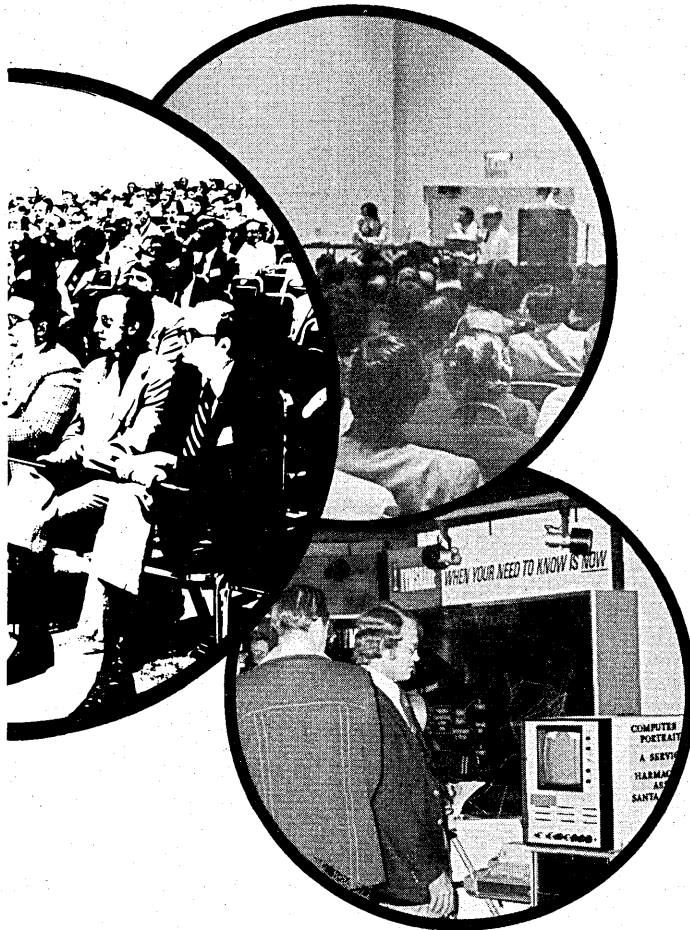

Program Productivity

Creative implementation and management of datacomm operations leads to improved productivity. As cost-effective ideas originate at various levels of datacomm experience, our conference goal is to offer complete management programs to build on each attendee's background.

For beginners, our DataComm School emphasizes fundamentals for management decision-making, rather than technical details. After sessions on product and service basics plus applications orientation, attendees develop a foundation to expand their knowledge in a variety of more advanced sessions to round out conference activities.

For the more experienced attendees knowledgeable in computers or communications, sessions on networking and operations management plus updates on products and services provide a complete program to assist in developing, using or expanding a data communications network.

For those advanced in applying datacomm, INTERFACE '77 has a full schedule of comprehensive Product, Service and Technology Workshops, plus a full schedule of important Highlight Sessions covering product advances and changing directions in industry issues and policies.

And for everyone, INTERFACE '77 offers Applications Workshops concentrating on those vital areas of concern to users such as EFTS, point-of-transaction, distributed computing systems, remote computing services, etc. Leading users and consultants from these operational environments will comprise panel sessions to discuss approaches for implementing such systems cost-effectively through data communications.

INTERFACE with Us

Plan today to be on the right path tomorrow - the critical path - to data communications success. Start by registering for Data Communications INTERFACE '77 - your next critical event. Send us the coupon below or call (800) 225-4620 (toll-free); (617) 879-4502 in Massachusetts.

Register for INTERFACE '77 now!
For Instant Registration
or Information
call Toll-Free (800) 225-4620

Within Massachusetts, call Collect (617) 879-4502

Registration Fees

- 1st and 2nd attendees, each
- 3rd and more attendees, each

3 Full Days	Single Days, Each
\$95	\$50
\$50	\$25

() My check is enclosed! () Bill me! () Tell me more! () I'd like to exhibit!

NAME _____ / TITLE _____

ORGANIZATION _____

ADDRESS _____
 (No. & Street)

(City) _____ (State) _____ (Zip) _____

TELEPHONE () _____

Other associates who should receive information.

NAME _____ / TITLE _____

NAME _____ / TITLE _____

DataComm INTERFACE, Inc., 160 Speen Street, Framingham, Mass. 01701.

advertisers' index

Omron Corporation of America,
Information Products Division ... 15

O.P.M. Leasing Services, Inc. 191

Optical Business Machines 201

Optima Enclosures, a division of
Scientific Atlanta, Inc. 38

Penril Corp. Data Communications
Division 211

Quest Systems Inc. 220

Questronics Inc. 184

RCA Service Company, A Division
of RCA, Technical Services..... 174

RJ Reynolds Industries Inc. 220

RSVP Services 238

Rusco Electronic Systems 87

†Saab-Scania 190-V, 190-W

Sanders Data Systems Group . 116, 117

Science Accessories Corporation ... 194

Shugart Associates 92

Software AG 237

Software International 218

Source EDP 228

†Stansaab Elektronik 190-E

Standard Memories, An Applied
Magnetics Company 210

Stromberg DatagraphiX, Inc. 133

Summagraphics Corporation 166

Sycor 122-125

Sykes Datatronics Inc. 224

†System Industries 190-I

Systems Engineering
Laboratories 10, 11

Tab Products Company 189

Talos Systems Inc. 4

Technical Publishing Company 200

Tektronix, Inc., Information
Display Group 54

Teled Corporation 176

Teletype Corporation 205, Cover 4

Texas Instruments Incorporated,
Digital Systems Division
..... 69-74, 120, 121

3M Company, Microfilm Products
Division 145

TWA Air Freight 101

United Airlines 195

University Computing Company . 9, 127

†U.S. Department of Commerce . 190-EE

Varian Data Machines 26

Versatec, A Xerox Company 207

Wang Laboratories, Inc. 126

Wiley-Interscience a Division of
John Wiley & Sons, Inc. 180

Wright Line, A Division of
Barry Wright Corporation 119

Xerox 39

Yourdon Inc. 221

Zeta Research 197

†European Insert Advertisers

DATAMATION

YOU MAY HAVE TO WRESTLE A FEW ALLIGATORS TO GET THERE

Major real-time software systems design and development projects require key individuals, preferably with a background in military systems.

Our client, one of the nation's largest and most prestigious equipment and systems innovators, is looking for professionals with outstanding technical credentials in the field of complex real-time software systems; ideally command and control, weapons, radar and communications. A background in some of these areas will be considered: **Software Simulation Design; Data Base Management; Intelligence Software; Software Project Management; Command & Decision Definition and Design; Radar Software; Weapons, Missile Simulation; Operating System Software Development; Structured Programming; Micro Programming Systems; Computer Systems Architecture; Weapon System Software; Real-time Software Design; New Business Acquisition; Radar and Communications System Programming; Real-time Executive System Design; Interactive Data Reduction Systems; Configuration Control.** If you have a successful background in some of these areas, we can offer long term career opportunities that include attractive immediate rewards, and extraordinary advancement potential. These ARE immediate openings. Please rush your reply, in complete confidence to:

6845 Elm Street, McLean, Virginia 22101
U.S. CITIZENSHIP REQUIRED

Representing an Equal Opportunity Employer M/F/H

LRC
ASSOCIATES

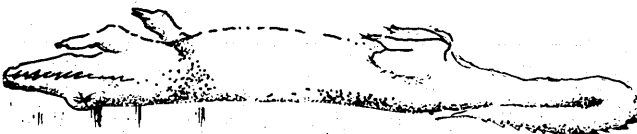

BUT YOU WILL MAKE SIGNIFICANT ADVANCES IN SOFTWARE DESIGN



**Technical
Publishing Company**

Arthur L. Rice, Jr., Chairman of the Board
James B. Tafel, President
Gardner F. Landon, Exec. Vice President
Calverd F. Jacobson, Financial Vice President
and Treasurer

Thomas A. Reynolds, Jr., Secretary
M. Jay Turner, Jr., Director of Circulation
Paul C. Jarvis, Director of Information Services

Advertising Offices

Eastern District Managers

A. Treat Walker,
Warren A. Tibbetts: Greenwich, Ct. 06830
35 Mason St. (203) 661-5400

New England District Manager & Vice President

Warren A. Tibbetts: Manchester, N.H. 03104
112 W. Haven Rd
(603) 625-9498

Midwest District Manager

John M. Gleason: Chicago, Ill. 60606
205 W. Wacker Drive
(312) 346-1026

Western District Managers

Alan Bolté, Jr.: Los Angeles, Calif. 90035
1801 S. La Cienega Blvd.
(213) 559-5111

James E. Filiatrault: Mountain View, CA 94043
2680 Bayshore Frontage Rd.
Suite 401
(415) 965-8222

U.K., Scandinavia, Benelux

Intergroup Communications, Inc.
Wallace K. Ponder, European Director
Paul D. Dimmock, Regional Manager
31 Lyncroft Avenue
Pinner, Middx, HA5 1JU
England
Tel: (01) 868 9289
Cables: PACOM, Pinner

Germany, Austria, Eastern Europe

Fritz Taeuber
Soltauer Strasse 85
D-314 Lueneburg
Germany
Tel: (0 41 31) 4 38 49

France, Switzerland, Italy, Spain

Gerard Lasfargues
32 rue Desbordes Valmore
75016 Paris
France
Tel: (1) 288 90 22

Japan

Shigeru Kobayashi
Japan Advertising Communications, Inc.
New Ginza Building
3-13 Ginza 7-chome
Chuo-ku, Tokyo 104, Japan
Tel. (03) 571-8748

Other  Magazines

Plant Engineering	Pollution Engineering
Power Engineering	Purchasing World
Research/Development	Consulting Engineer

**Beat the Big One...
Heart Attack
Give Heart Fund**



A CHALLENGE IN Advanced State-of-the-Art

NCR's Terminal Systems Division at Ithaca, New York is continuing its expansion as a leader in the data terminal industry. We are now aggressively involved in the design and manufacture of microcomputer systems. Located in New York's scenic Finger Lakes region, we offer an exceptional living environment of a growing, yet peaceful and sophisticated university town atmosphere coupled with bountiful educational and recreational facilities.

ADVANCED DEVELOPMENT

Openings exist for key people to participate in the definition of next generation intelligent microprocessor based terminal systems.

Senior Systems Analyst

- Determine system requirements, hardware/software tradeoffs, mini/micro architectures
- Interface with hardware and software designers, marketing and corporate officers
- Evaluate and recommend present and future levels of technology in microprocessor system components, memories and peripherals

Senior Design Engineer

- Evaluate and recommend present and future tradeoffs for displays, LSI, and peripherals: model hardware performance specification, functional specification writing
- Experience in design and interfacing of mini/micro systems: knowledge of architecture for high level machines

All of the above require BSEE or Computer Science and 3-7 years experience.

SOFTWARE DEVELOPMENT

Systems Analysts and Programmers

- Communication, asynchronous and synchronous terminals, protocol
- Software development tool design
- Knowledge of operating systems; peripheral drivers, file management, systems generator
- BASIC Language implementation on general purpose terminal
- Knowledge of 8080 a plus

Senior Software Analysts

- All the above
- High level language definition: experience in PASCAL, translators, and interpreters desired
- Analysis, definition and specification writing

All above require BS in Computer Science or related degree and 2-7 years practical experience.

If you can meet our kind of challenges and want an outstanding compensation and benefits package, please send a current resume. Include salary history and requirements with resume. We will treat your application in strictest confidence and will not contact present employer without your permission. Relocation assistance, if hired. Please write:



An Equal Opportunity Employer

Michael A. Friedenbergl
Professional Recruitment
Terminal Systems Division—Ithaca
NCR Corporation
950 Danby Road
Ithaca, N.Y. 14850

In the world of graphics, CØMPLØT® has a plotter that works for you.

An unmatched team:
The CØMPLØT
PTC-5 at \$1945 and
the DP-1 at \$3550.

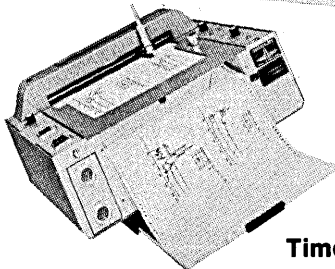
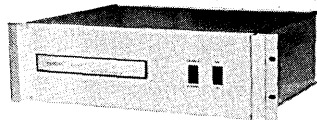

Timeshare

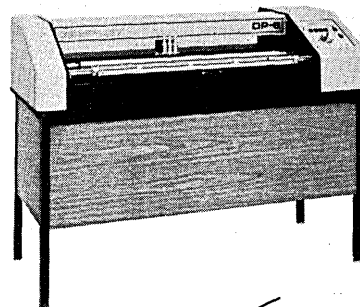

The all new 36"
CØMPLØT DP-8
Digital Plotter in 3
models from \$7600.
plus the MTR-4
Magnetic Tape
Reader at \$15,500.

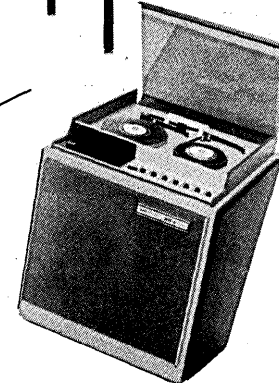

Offline

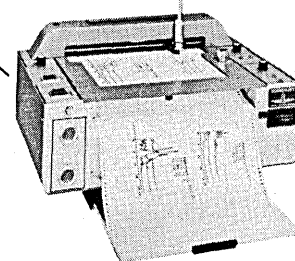
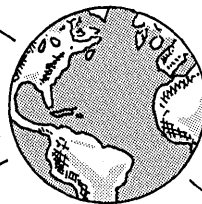

Online

DP-1 — \$3550., 450 steps per second
on 11" x 144" chart paper.

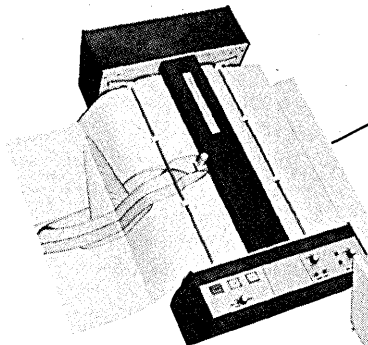

The CØMPLØT DP-3 22" wide
plotter at \$5150. plus the model
BTC-7/734 Interface to the CDC
734 user terminal — \$2595.

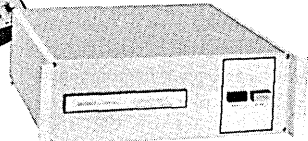

Remote batch

® A Registered trademark of Houston Instrument.

The CØMPLØT line is universally accepted for all applications — including graphing patient isodose levels in nuclear medicine, drawing subdivision plats, plotting load and strain data or preparing maps and other three dimensional charts. From a true cost/performance standpoint, you owe it to yourself to investigate the CØMPLØT line. Write or call today.

houston
instrument

THE
RECORDER
COMPANY

DIVISION OF BAUSCH & LOMB

ONE HOUSTON SQUARE (at 8500 Cameron Road) AUSTIN, TEXAS 78753
(512) 837-2820 TWX 910-874-2022 cable HOINCO

TELECOPIER

EUROPEAN OFFICE

Rochesterlaan 6 8240 Gistel Belgium
Phone 059/277445 Telex Bausch 19399

the forum

Formula for a Consent Decree?

Make no mistake; the outcome of the IBM antitrust trial is important. Even if in the end it all fizzles out in some inconclusive mumbling or ineffective remedies, it will be a milestone in the economic, political, and ideological history of our country. If it doesn't fizzle, the value of the trial will be incalculable in the clarification of the relationship between large publicly-held corporations and the government which is supposed to represent all of us. Yet there has been remarkably little public comment on the trial, and much of that comment has been parochial.

Apart from the Department of Justice itself, about the only institution that has taken a continuing interest in this matter has been the Computer Industry Association, a trade association of nearly 40 third-tier companies. In March, the CIA's president, A.G.W. Biddle, proposed that the antitrust trial be settled by a consent decree based upon a six-point plan. Whether the CIA proposal will influence the course of the legal proceedings remains to be seen, but since CIA is running the only game in town (unless you believe the whole matter should just be left to the lawyers for IBM and the government), its proposal deserves careful analysis.

A general view of the proposal reveals the following shortcomings:

- The proposal sacrifices an opportunity for confronting a major social problem, which takes time to resolve, for the sake of a quick resolution which may benefit only a particular industry.

- At a point when the best positions of both sides have not yet been stated, the proposal compromises away important values on one side without any hard bargaining.

- While containing several constructive elements, the proposal does not fully consider important and relevant economic and social factors.

Let's look at each of the proposal's points and show why we reach these conclusions. (The points are paraphrased here. A more complete version of them can be found in the March, 1976 issue of the CIA newsletter, *On Line*.)

1. *IBM would be required to disclose to the entire industry all functional interfaces and protocols developed by IBM's systems architects at the same time they are provided to IBM's hardware and software implementation people.*

This provision actually entrenches IBM's control over interfaces, giving up any prospect of industry-wide determination of such matters. IBM had in the past allowed more venturesome firms to open new markets and subsequently came into these markets, with far greater resources, to preempt the innovator's position. Good as it is to require IBM to disclose its interfaces, it protects only the technological followers, not the leaders. Furthermore, IBM has the capacity to develop alternate products in many markets and can whipsaw its potential competitors into and out of design commitments by bringing on and taking off alternate interfaces at a bewildering rate.

What is needed is some degree of public exposure of the decision process in developing interfaces. One way to achieve some public control over interface proliferation would be to set up a Computer Industry Standards Board. IBM would be required to support the CISB and to comply with its rules; support and compliance by other, non-dominant, members of the industry would be voluntary. New

interfaces would be registered with the CISB along with technical justification for their design. Where an interface was functionally equivalent to one that had been registered earlier, it would be approved as a standard only if it had a genuine technical advantage, not merely partisan marketing significance.

2. *IBM's (actually, its shareholders') capital would be recycled by assigning \$2 billion to a new Computer Industry Acceptance Corporation which would finance the purchase of data processing equipment of all manufacturers, including IBM, at reduced interest rates.*

Lavish capitalization makes the work of management easy, so there is no internal incentive for management to release retained earnings. Clearly, if sheer wealth, rather than more subtle and diverse kinds of business skills, is not to become the ultimate determinant of success, some outside agency is needed to direct the application of large concentrations of capital toward enterprises which inherently require massive capitalization. Such enterprises are, typically, unique and fundamentally monopolistic, and therefore properly subject to government regulation. In other words, accumulation of capital, by its nature, invites regulation.

The CIA proposal is right in suggesting the transfer of part of IBM's capital to another enterprise but wrong in its proposed charter for that enterprise. This is particularly surprising in view of CIA's professed ideology of free-market competition, for to offer a discount to customers of computer manufacturers would distort the free-market allocation of capital in serious ways. A short-run benefit to the makers of such equipment would be obtained at the expense of efficient capital allocation.

IBM has been traditionally weak in innovations, and it is in the areas of equity financing, venture capital, and research and development funds that capital shortages are chronic. The institution that receives any excess capital from IBM should have more the character of an investment bank than an acceptance corporation. It should not be barred from equipment financing, but should do so only at prevailing interest rates. The institution should specialize, however, in new issues, both debt and equity, including a fair proportion of speculative ventures in technically or socially innovative areas. Some limitation would be placed on reinvestment in ventures controlled by IBM management, for, after all, the idea is to prevent this concentration of capital from reinforcing the dominance of IBM.

3. *IBM would be required to "unbundle" all of its products and services and be prohibited from cross-subsidizing products and services within IBM.*

This requirement would enable non-IBM enterprises to put together systems that included IBM products along with "foreign" products, obviously a competition-promoting situation.

An agreement by IBM to sell to all comers any product component, or service that it has offered to any customer (except government agencies) would be substantially self-enforcing. Without an injunction against cross-subsidization, however, such an agreement would be of limited value, and that kind of injunction is not self-enforcing but requires an outside agency and public disclosure of hitherto proprietary information. Let's return to this point after discussing the fourth element of the CIA plan.

4. *There would be established an industry-wide code of ethical business conduct.*

IBM now has such a code for its own use. Biddle correctly points out that such an internally-enforced code puts the IBM salesperson in an unfair double bind: lose an account and lose your job, but you can't do certain things to keep the account that your competitors' salespersons may do. An industry-wide code would eliminate this kind of pressure on the front-line troops.

An industry-wide code does not address itself, however, to the problem of IBM's dominance. Nor does the establish-

KUWAIT INSTITUTE FOR SCIENTIFIC RESEARCH

Positions are now available for *applied scientists* and engineers with proven research experience and leadership record in the following areas:

- *Materials and Engineering* (material science and technology, petroleum, petrochemicals, building materials, energy systems, nuclear energy, engineering design, etc.).
- *Environmental and Earth Sciences* (environmental studies, air and water pollution, geological and geophysical surveys, etc.).
- *Agriculture and Marine Resources* (marine-culture, fisheries, agriculture, food processing, etc.).
- *Science and Technology Policy* (technology assessment and transfer, socio-economics, demography, manpower development, etc.).
- *Applied Mathematics, Physics and Chemistry* related to the above areas.
- *Computer Science and Applications.*

The *Kuwait Institute for Scientific Research* located on the shore of the Arabian Gulf, is in the process of ambitiously expanding its presently active capabilities so as to meet the research and development requirements of a rapidly developing country—and a region—with adequate financial resources, and a strong commitment to science and technology. Great opportunities exist for vigorous and dedicated scientists and professionals. There is also a possibility of teaching at a strong and growing university nearby.

Salaries highly competitive; additional benefits include: free, furnished modern housing; free medical services; and yearly vacation tickets to country of citizenship (or permanent residence).

Preference will be given to Arabic-speaking individuals (because of language and social atmosphere) but serious considerations will also be given to other English-speaking scientists.

Please send resumes (including list of publications) to: *Recruiting Committee, Kuwait Institute for Scientific Research, P.O. Box 12009, Kuwait.* Also ask three referees to write to this address on your behalf. Interviews will be conducted at the convenience of the candidates.

CIRCLE 152 ON READER CARD

EDP SEARCH

WHY IS FOX-MORRIS THE FIRST CHOICE OF EDP PROFESSIONALS?

A recognized staff of professional experts offering LOCAL, REGIONAL & NATIONAL COVERAGE through our direct branches as well as coast to coast coverage through our 75 member firms of *National Personnel Consultants, Inc.*

Completely confidential service geared to your career objectives.

Unparalleled contacts with industry based on years of successful results. Professional resume evaluation and career guidance.

Client companies assume all employment costs—including interview expense, relocation (if necessary) and search fee.

SEND RESUME DIRECT, OR CIRCLE NUMBER BELOW ON READER CARD.

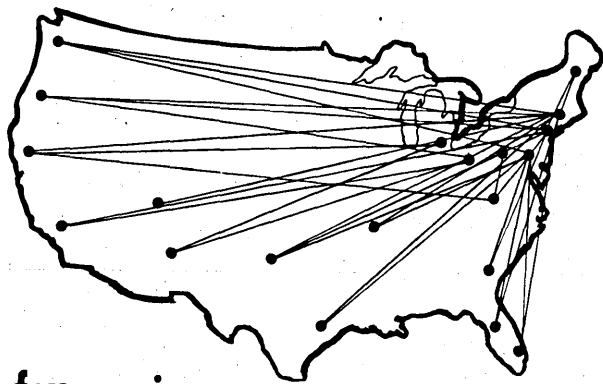

fox-morris personnel consultants

Philadelphia: (215) 561-6300, 1500 Chestnut St., Philadelphia, Pa. 19102
 New York: (212) 697-1820, 605 Third Ave., New York, N.Y. 10016
 Pittsburgh: (412) 232-0410, 6 Gateway Center, Pittsburgh, Pa. 15222
 Wilmington: (302) 654-4465, 2005 Concord Pike, P.O. Box 7017, Del. 19803
 Princeton: (609) 452-8135 3490 U.S. Rt. 1, Princeton, N.J. 08540
 Baltimore: (301) 296-4500, 409 Washington Ave., Baltimore, Md. 21204
 Charlotte: (704) 527-4980, 4000 Park Road, Charlotte, N.C. 28209
 Atlanta: (404) 321-3888, 2200 Century Pkwy., N.E., Atlanta, Ga. 30345

CIRCLE 156 ON READER CARD

the forum

ment of a code by IBM, with occasional exemplary public chastisement of apprehended violators of that code by IBM management, supply an adequate solution. What is needed is a standard of behavior clearly seen to be operational, not a statement of corporate policy to be used to exculpate the corporation from the deviant acts of its servants when they occasionally come to light. Ultimately, codes of business practice cannot remain a tool of corporate management but must, if they are to be credible, become public matters.

The problems of cross-subsidization and the enforcement of business practices take us to the crux of the IBM situation. Given that IBM dominates its industry, there are no one-shot steps that will eliminate that dominance, at least not without opening a door to other, possibly worse, evils. Nationalization is not only politically unacceptable in this country, it is also, on good evidence, a formula for practical economic disaster. Nor does it make sense for the government to regulate an industry which, but for the dominant firm, is quite competitive. What is needed is a more pragmatic and flexible mechanism that works within our national tradition of checks and balances.

The key lies in public disclosure (see Nancy Foy's comment, September 1974, p. 185). When a firm is dominant and not effectively restrained by competition, it should lose the ordinary protections of privacy and become subject to special public scrutiny.

For example, one can conceive of a supervisory body having powers to overrule the board of directors and with access to all the facilities of the firm. This body would be charged with responding to the public interest, leaving the traditional board of directors to pursue the traditional objective of profitability. The supervisory body would, by design, not be dominated by the firm's management but would have authority to command that management. Being responsible to the public, it would be the first point of contact between the public and the firm in all matters that lay outside the usual course of business. It would enforce compliance with standards, the prohibition of cross-subsidization, and the business practices code, and would conduct its affairs in public view.

This is not the place to spell out in fine detail the charter of such a body nor to propose other alternatives. It can be seen, however, that the central question is not one of devising injunctions, codes, or restrictions to limit the options of management but rather of devising structural changes to make public things which were private. The failure to place such fundamental structural changes on the agenda is the most serious weakness of the CIA proposal.

5. *The agreement IBM made with Control Data Corporation to stay out of the data service business when IBM sold the Service Bureau Corporation to CDC would be extended for ten years. During that time, it would be expected that a healthy, competitive market for such services would be built up by others. IBM would be allowed to return to this market in ten years.*

6. *IBM would be barred from entering the communications business as a common carrier. Communications and computers are so interdependent that control of communications can provide a tool for dominating the computer market.*

These last two points of the CIA plan are simply not carefully thought out. To prohibit IBM from entering the data service business for a fixed period does not do much to invite development of competition in that market. Ten years is not such a long time, and the knowledge that at the end of a decade the market may be preempted by IBM's massive resources does not inspire investor confidence. The key point here is that the data service business does not require

the kind of capital IBM can put into it; with the decreasing cost of hardware, the capital barrier to entry has been declining. There is no economic justification for allowing IBM, with both its manufacturing and financial resources, back into the data service business at any time. Indeed, it is precisely that kind of vertical integration that has been a chronic antitrust problem. IBM should be barred permanently from the data service business.

On the other hand, IBM's move into the communications business, although not without its perils, is a thoroughly enlightened step to be encouraged but carefully monitored. This step accomplishes the following:

- It provides a place for an immediate investment of a significant portion of IBM's excess capital in a socially valuable facility that few other institutions could finance.
- It immediately classifies a significant portion of IBM as a regulated natural monopoly without litigation or new regulatory agencies or laws.
- It creates conditions of new, credible, and regulated competition between IBM and AT&T, providing alternate facilities that can form the basis for practical economic and technical comparisons.
- It sets up an avenue for IBM to shift resources out of an increasingly competitive computer industry into a regulated industry that can not only absorb its capital but also its technical skills.

This is not to say, however, that the concerns of the CIA are not legitimate. On the contrary, the threat of intrusion of regulation into the competitive sectors of the data processing industry and the possibility of a common carrier using its position to monopolize attachments to its network are both serious, deplorable matters. They are, nonetheless, matters which are susceptible to control by attention to certain interfaces or boundaries and do not justify sweeping prohibitions. As closely as the transmission and processing of data are related, it should not be impossible to draw a line between the two disciplines and markets. We should set about doing so, and once done, we should defend that boundary diligently.

The caption on the editorial in the CIA's newsletter putting forth the plan reads, "Peace in Our Time?" The words evoke memories of a similar phrase uttered by Neville Chamberlain after the Munich conference of 1938. Chamberlain thought to secure an era of stability by conceding a few points; he badly misjudged the dynamics of the system with which he was dealing. The analogy can be overdrawn, but it is all too easy to base one's position on what one wants to believe about the situation rather than actuality. Quick compromise may bring only a brief sense of relief followed by a long period of regret.

—Sander Rubin

Mr. Rubin is the principal of Wordsworth Systems, a consultancy in Davis, California. His last comment on the IBM case appeared in September 1975 ("Supervision is Better than Regulation," p. 99).

Next Step in Urban Transit? Let's Not Take it Yet

It is true that there is room for improvement in urban transit systems, as "Next Steps in Urban Transit," by Harry Carroll (February, p. 86), states. However, data processing professionals should not be misled that only mayors' fears of lawsuits or transit commissioners' denunciations of "Buck Rogers technology" are blocking major applications of Personal Rapid Transit systems today.

PRT's face a number of serious aesthetic and technological obstacles. For instance, although artistic renderings of PRT guideways show them to be sylph-like, almost invisible, these cartoons ignore structural analysis. This analysis is

ADABAS PERFORMS BETTER THAN ANY OTHER DBMS.

That's quite a claim...but that's what 12 independent surveys showed.

A Computerworld study says we're first in capabilities. Our performance also comes out on top in benchmarks by several major companies in a wide variety of industries. And we're rated first by state, county, and city governments.

Why does everyone like us so much? Maybe it's because of advantages like these:

1. With Adabas, you can cut your ongoing program maintenance by as much as 75%.
2. You can drastically reduce time and money needed to develop new applications.
3. You'll keep people on the job instead of in the class, because it takes just 3 days to learn Adabas.
4. You'll greatly increase your capabilities while reducing on-line storage requirements by an average of 25%.
5. You can get answers from your computer in seconds that used to take days. And you can supply more people with more answers than ever before.

To get all the facts about Adabas, fill out the coupon today or call (703) 860-5050.

By the way, we'll be glad to show you any or all of the surveys mentioned above. We perform better...and we can prove it!

 **software ag**
OF NORTH AMERICA, INC.

Reston International Center,
11800 Sunrise Valley Drive, Reston, Va. 22091.

Name _____
Company name _____
Street _____ City _____
State _____ Zip _____ Phone _____
Type of computer _____

PROGRAMMERS AND ANALYSTS

Free Employment Service

Serving Northeast, Southeast and Midwest U.S.

- Scientific and commercial applications
- Software development and systems programming
- Telecommunications
- Control systems
- Computer engineering
- Computer marketing and support

Call or send resume or rough notes of objectives, salary, location restrictions, education and experience (including computers, models, operating systems and languages) to either one of our locations. Or check the reader service card for a free sample resume. We will answer all correspondence from U.S. citizens and permanent residents and will guarantee our best efforts in a professional and ethical manner to all qualified applicants that we think we can help. Our client companies pay all of our fees.



RSVP SERVICES, Dept. M
Suite 700, One Cherry Hill Mall
Cherry Hill, New Jersey 08002
(609) 667-4488

RSVP SERVICES, Dept. M
Suite 300, Dublin Hall
1777 Walton Road
Blue Bell, Penna. 19422
(215) 629-0595

RSVP SERVICES

Employment Agency for Computer Professionals

CIRCLE 154 ON READER CARD

MANAGER MANAGEMENT INFORMATION SYSTEMS

Friedrich is a major manufacturer of residential/commercial air conditioning and refrigeration equipment with plants located in San Antonio, Texas, Utica, New York and Ft. Lauderdale, Florida. Due to promotion from within, we are searching for an individual with outstanding Management capabilities to head up our Management Information Systems Department. This position reports to the Vice-President and Controller, Friedrich Group and includes full responsibility for development and implementation of Management Information Systems in a multi-product, multi-plant environment.

The ideal candidate will have an appropriate degree plus 8-12 years experience with considerable exposure to fabrication and assembly line manufacturing, marketing and product distribution. Prior management experience in either manufacturing or marketing coupled with direction of a Management Information Systems group is highly desirable.

The position is located in San Antonio with limited travel. Interested applicants should send a detailed resume, including salary history and requirements to Mr. Richard Nowak, Manager of Management Development and Employment.

FRIEDRICH GROUP WYLAIN, INC.

P.O. Box 1540
San Antonio, Texas 78295

An equal opportunity employer Male/Female

CIRCLE 155 ON READER CARD

the forum

needed to determine if the structure will twist or sag when cars and people move on it or winds blow it or collapse if a truck collides with a guideway support column. In addition, the ride quality of extra-light vehicles flying along the track, or swaying in the wind (ever been on a gondola ride?), must be ascertained.

Even if guideways could be as ethereal as one wanted, stations and switching complexes could not. Stations must contain space for stairs, elevators, fare collection equipment, the several platforms and tracks in the station needed to avoid delays and to store cars. Each intersection would have its share of aerial spaghetti to enable vehicles to switch from one link to another, blotting out what little sun isn't blocked by skyscrapers. No, such an extensive network could not be up in the air. If PRT networks cannot be built on the surface, it might be wiser to wait until a small electric car is available.

Good systems engineering will certainly be required for the proposed PRT if Carroll's plan to stuff utility lines inside the guideways is adopted. A better idea and one which would not create problems of interference and noise for the control system would be to "stuff" the sewer lines in the guideways and bury the utility lines. Such maneuvers as one automatic vehicle pushing a disabled vehicle must be carefully considered. If the brakes of the failed vehicle are on, the traction motors on the pusher may burn out. If this or other emergency procedures cannot be performed in the automatic mode, backup controls for manual operation should be investigated. A full manual capability is also useful during the installation, testing and debugging phases.

Serious problems exist in attempting to transmit and receive signals between vehicles and the central control at very short headways. One must ensure that one vehicle does not receive and respond to signals meant for another and that central doesn't mistake indications from one vehicle for those of another. Indications from a real train which are not received or those which are received (due to bugs) from nonexistent trains can upset the hardest of control systems. Since there can be 60,000 vehicles on the system (500-mile network, 1-second headways, 30 mph speeds), these problems are real.

Transit vehicles do not possess the precision of a rocket to the moon—tolerances for accelerating, braking and speed maintenance can be about ± 5 percent. Even if design tolerances were narrower, vehicles probably would not be maintained at such levels. As a result, random variations in run time can be much greater than the 1-second headways. Furthermore, since each vehicle passes a merge point every six seconds (one merge point per block), a schedule deviation of one train can rapidly disrupt the entire network's schedule, requiring a major dynamic rescheduling. Unless the entire system operates at substantially less than capacity, there is no assurance that infinite loops could be avoided.

In sum, then, professionals in the transportation field are aware that: (1) Engineering considerations could materially affect the appearance of the guideway. (An extensive aerial network would not be acceptable anyway.) (2) Reliable command and control systems for such networks do not exist. (3) Variability in equipment performance can lead to perpetual rescheduling. Finally, the systems engineering task for such a system—in which so many components and subsystems exist only on paper or in a laboratory—could well be the hardest part of the job. So there are good reasons for keeping PRT in the experimental stage until these issues are resolved and why it should not be the "Next Step."

—David M. Weiss

Mr. Weiss is a transportation engineer with Gibbs & Hill, Inc., New York, N.Y.

"OMR..."



... for decentralized data collection ... as accurate as verified keypunch

Yes, as accurate as verified keypunch . . . and source data used directly, so there are no delays or errors in entering data. Plus . . . a series of powerful off-line edits (on-line too!) mean a "smart OMR" and improved quality of computer reports.

With a Bourns Optical Mark Reader, you get a really good deal. You get faster turnaround on input data with source data entry. You spend less because OMR data entry preparation is just one step. You improve accuracy of data entry because OMR intelligence comes before your computer.

What else? Well, how about an entire company dedicated to solving your problems. From application, card design, programing, and field service to the guys and gals at the factory, we have a whole bunch of people just waiting to do their best for you.

For the latest in "smart OMR's," why not call today? It might make your life a little less complicated. Bourns, Inc.—Management Systems Division, 6600 Jurupa Avenue, Riverside, California 92504. Phone: 714-687-7220.

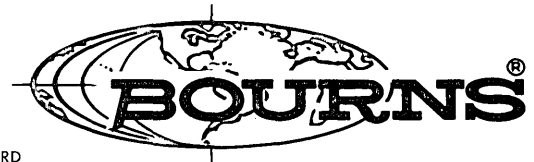

CIRCLE 2 ON READER CARD

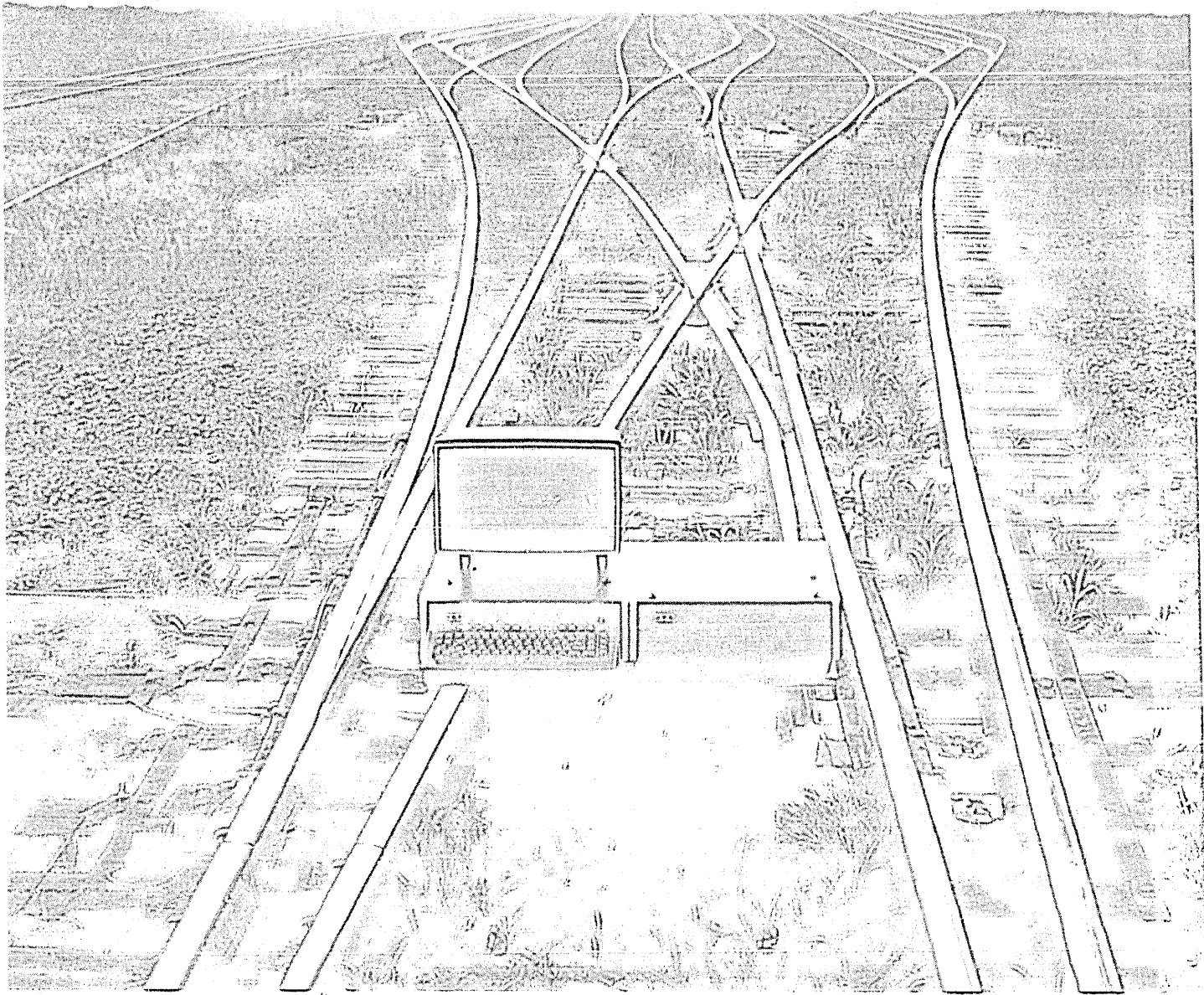

When it comes to flexibility, the model 40 gives you a lot of ways to go.

When we designed the model 40 system, we included a long list of features and options to give it the flexibility for practically any data transmission requirement. Whatever your industry or application.

First, there's a variety of speeds ranging from 1110 to 4300 bps, along with a choice of interfaces, half/full duplex operation and character and batch mode transmission. The model 40 system also has a number of on-line controls, even/odd parity generation and a destructive scrolling feature that permits continuous bottom line reception with no loss of data until memory overflow.

Flexibility features don't stop there, either. There's an expandable memory with line and page scrolling, protected format with variable field transmission, plus many other features and options to select from. And since the entire system is modular, it can be custom-tailored to fit your needs.

These are just some of the many reasons why the model 40 has the flexibility to fit just about any system. But the model 40's strongest suit is economy. Because on a cost/performance basis, nothing even comes close. And delivery is a lot sooner than expected.

For complete information, please contact our Sales Headquarters at 5555 Touhy Ave., Skokie, Ill. 60076. Or call Terminal Central at (312) 932-2000.

Teletype is a trademark and service mark registered in the United States Patent and Trademark Office.



The Teletype model 40 system. Nothing even comes close.